

Analysis of Cationic Lipids Used as Transfection Agents for siRNA with Charged Aerosol Detection

Gurmil Gendeh, Dionex Corporation, Sunnyvale, CA, USA; Marc Plante, Bruce Bailey, Christopher Crafts, and Ian Acworth
ESA—A Dionex Company, Chelmsford, MA, USA

ABSTRACT

Short segments of RNA, called small interference RNA (siRNA), are being investigated as novel approaches to treat numerous conditions, including cancer, AIDS, diabetes, age-related macular degeneration, and hepatitis.^{1,2,3} In order to effectively penetrate the cell membrane, the RNA complex is encapsulated with transfection reagents to provide a net positive charge. Suitable transfection reagents include the use of cationic liposomes, polyethylene glycol (PEG)ylated nanocarrier complexes, polymeric systems (dendrimers, polyplexes, and natural polymers) and cell-penetrating peptides. As clinical trials proceed to final stages, quality control measurements of purity and quantity of these cationic lipid delivery agents will be required.

A high-performance liquid chromatography (HPLC)-charged aerosol detection method enabling purity assessment and quantitation of commonly used cationic lipids is described. Five cationic lipids (CL) were chosen, including 3β -(*N*-(*N*′, *N*′-dimethylaminoethane)-carbamoyl)cholesterol hydrochloride (DC-Chol), 1,2-dioleoyl-3-trimethylammonium-propane (DOTAP, chloride salt), dimethyldioctadecylammonium bromide (DDAB), 1,2-di-*O*-octadecenyl-3-trimethylammonium propane (DOTMA, chloride salt), and 1,2-dioleoyl-*sn*-glycero-3-phosphoethanolamine (DOPE). The Thermo Scientific ESA Corona® *ultra*™ Charged Aerosol Detector (CAD®) a sensitive, mass-based detector, is especially well-suited for the determination of nonvolatile analytes. Purities of five cationic lipids were compared to those of the manufacturer's certificates of analysis. Response for these analytes was found to be independent of chemical structure. This method yielded limit of detection (LOD, signal-to-noise [S/N] ratio = 3) values of <10 ng on column (o.c.), with correlation coefficients for second-order polynomial fits >0.9997 for all five analytes from 3–2000 ng o.c., and with high precision. With this level of sensitivity and dynamic range, it is possible to detect impurities at 0.1%, making this an important tool for the quality control of cationic lipid reagents used with potential siRNA products.

INTRODUCTION

In the field of siRNA transfection, much progress has been made in advancing the specific transfection agents used to carry the siRNA molecule through a cell membrane and later detach from it once inside the cell. From here, the siRNA can attach itself to the targeted RNA sequence with the aim of suppression of undesired traits. To better ascertain the performance of these transfection agents, which are largely comprised of cationic lipids, we have developed an analytical method which can determine the content and purity of these agents.

Along with ionic strength, temperature, pH, and concentration, impurities of a cationic lipid can affect transfection efficiency.⁴ Because many unsaturated cationic lipids can form peroxides, qualification of a reagent purity is an important factor for both research and a released product.

Previous HPLC methods used reversed-phase chromatography with evaporative light-scattering detection (ELSD), as these analytes do not typically possess an ultraviolet chromophore. Sensitivities were generally poor, with limit of quantitation (LOQ) values of 300 ng o.c.,⁵ requiring large amounts to be analyzed to obtain purity estimates. Charged aerosol detection using the Corona CAD provides greater sensitivity and a wide dynamic range that allows for the quantitation of the parent analyte and its impurities in the same analytical chromatogram. With a high sensitivity (LOD as low as 2 ng o.c.), the HPLC-CAD method can detect low-level impurity amounts without overloading the column. This level of sensitivity provides a means for impurity detection to 0.1% at 2000 ng amounts o.c..

The CAD provides a sensitive and precise measure of nonvolatile and most semivolatile analytes, with response proportional to the mass of analyte o.c.. It is simpler and less costly to operate than mass spectrometers (MS), and it also provides a more uniform relative response than other detectors,^{6,7} including UV, ELSD, and MS. The detector works by measuring the amount of charge placed on analyte particles, as shown in Figure 1, and response is not dependent on light scattering, which is affected by different light-scattering mechanisms that cause a large response variability and generally lower sensitivity.

As regulatory agencies begin to prepare guidelines for these new siRNA therapies, the study of impurities and degradants must be considered. Amino acids have varying extinction coefficients and resulting peptides and their fragments will have variable responses when using UV detection. HPLC with universal detection that exhibits consistent response factors provides better estimates of impurities. The Charged Aerosol Detector (CAD[®]) is a sensitive, mass-based detector, especially well-suited for the determination of any nonvolatile analyte, independent of chemical characteristics. It has been used for many different types of assays, from low molecular weight ions to the analysis of larger polymers such as PEG. Charged aerosol detection, with response independent of chemical structure, is ideally suited for the measurement of peptides and impurities. Here, the authors explore the use of HPLC using a CAD detector for:

- A. Direct amino acid analysis
- B. Tryptic digest of a protein
- C. Cell-penetrating peptide analysis
- D. Forced degradation of cationic peptides

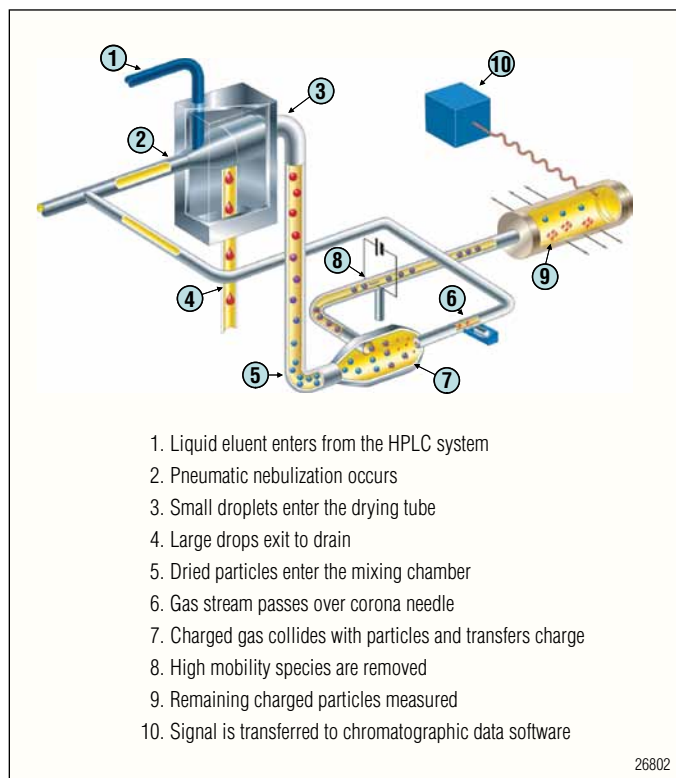

Figure 1. CAD flow path schematic.

METHOD

Analytical Conditions

HPLC System:	Thermo Scientific Dionex UltiMate [®] 3000 RSLC															
Column:	Fused-Core [®] C8, 2.7 μ m 150 \times 4.6 mm															
Mobile Phase A:	Water/methanol/trifluoroacetic acid (600:400:1)															
Mobile Phase B:	Alcohol*/tetrahydrofuran/ trifluoroacetic acid (750:250:1)															
Gradient:	<table border="0"> <thead> <tr> <th>Time (min)</th> <th>% B</th> <th>Curve</th> </tr> </thead> <tbody> <tr> <td>0.0</td> <td>45</td> <td>–</td> </tr> <tr> <td>20.0</td> <td>75</td> <td>2</td> </tr> <tr> <td>20.1</td> <td>45</td> <td>5</td> </tr> <tr> <td>25.0</td> <td>45</td> <td>5</td> </tr> </tbody> </table>	Time (min)	% B	Curve	0.0	45	–	20.0	75	2	20.1	45	5	25.0	45	5
Time (min)	% B	Curve														
0.0	45	–														
20.0	75	2														
20.1	45	5														
25.0	45	5														
Flow Rate:	0.5 mL/min															
Injection Volume:	2.00 μ L															
Column Temperature:	45 $^{\circ}$ C															
Detection:	Corona <i>ultra</i> CAD															
Corona Filter:	High															
Corona Nebulizer Temperature:	15 $^{\circ}$ C															
Sample Temperature:	15 $^{\circ}$ C															

*JT Baker #9229 Alcohol, Anhydrous, Reagent, PHOTREX Reagent made from specially denatured alcohol formula 3A and 4–6% isopropyl alcohol

Standard Preparation

All standards were dissolved in methanol/chloroform (1:1) to a concentration of 2000 μ g/mL, and diluted serially in methanol/chloroform to a concentration of 3.1 μ g/mL.

RESULTS AND DISCUSSION

A chromatogram of the five standards is shown in Figure 2. Peak retention times (in minutes) were found to be: DC-Chol. 5.95, DOTMA 7.88, DOTAP 10.7, and DOPE 12.7.

The calibration curves for the five cationic lipids are presented in Figure 3. Data were fit using second-order polynomials, resulting in

respectively. The amounts for LOD and LOQ for the five cationic lipids are shown in Table 1.

Method precision values were $< 5\%$ RSD for all concentrations above 12.5 ng o.c., indicating a high level of reproducibility, even at low

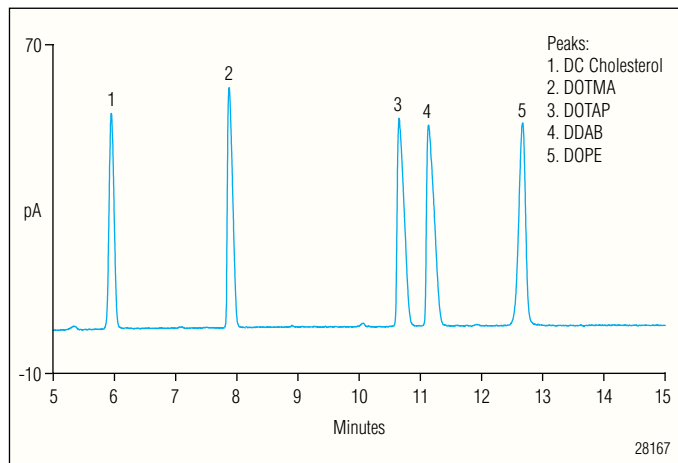

Figure 2. HPLC-CAD chromatogram of five cationic lipids, at 800 ng o.c..

correlation coefficients $r^2 > 0.9995$. Triplicate injections provided peak area reproducibility with an RSD $< 7\%$ for all amounts ≥ 25 ng o.c.

Sensitivity was determined through sequential dilutions, basing the values on amounts o.c. S/N ratios equal to 3 and 10 for LOD and LOQ,

Table 1. LOD and LOQ Values for Cationic Liquids		
Analyte	LOD (ng o.c.)	LOQ (ng o.c.)
DC-Chol	5	15
DOTMA	4	11
DOTAP	3	10
DDAB	2	7
DOPE	5	13

amounts o.c..

Purity determinations were made using each of the 2000 ng o.c. standards. To calculate the mass percent of impurities in each of the cationic lipids analyzed, the calibration curves for amounts 3–25 ng o.c. of the parent analyte were used. This provided a more accurate means of determining the impurity amount, as the effects on calibration of the significantly larger parent analyte amounts are removed.

Chromatograms used for impurity calculations for DC-Chol and DOTMA are shown in Figures 4 and 5, respectively. The amounts of impurities

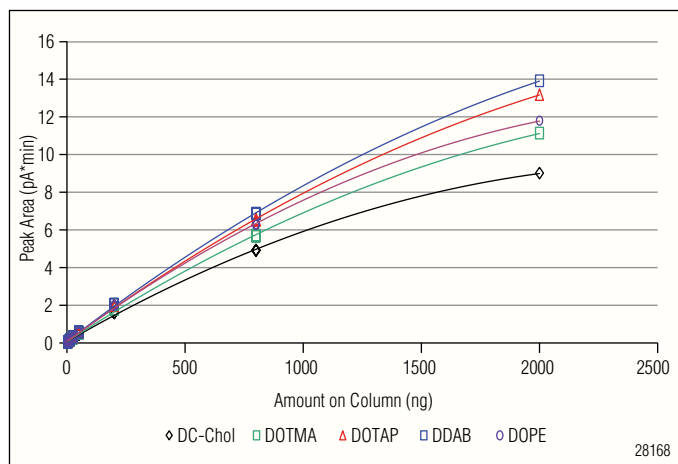

Figure 3. Calibration curves for five cationic lipids, from 3–2000 ng o.c. ($n = 3$).

Table 2. Purity Results for DC-Chol, DOTMA, and DDAB

Sample	Peak	Retention Time (min)	Amount (Area Percent)	Amount (ng o.c.)	Amount (Mass Percent)
DC-Chol	Unknown-1	4.457	1.56	13.3	0.64
	Unknown-2	3.842	1.07	8.5	0.41
	Unknown-3	5.353	2.28	21.1	1.01
	DC-Chol.	5.912	95.09	2037	94.9
DOTMA	Unknown-1	7.095	0.41	<LOD	(n.d.)
	Unknown-2	7.508	0.17	<LOD	(n.d.)
	DOTMA	7.827	99.47	2021	100.0
	Unknown-3	8.905	0.36	<LOD	(n.d.)
DDAB	Unknown-1	10.075	0.99	9.4	0.46
	Unknown-2	10.665	0.16	<LOD	(n.d.)
	DDAB	11.045	97.18	2013	98.8
	Unknown-3	11.932	0.35	2.8	0.14
	Unknown-4	12.652	1.31	12.9	0.63

are presented in Table 2, indicating both area percent and the correlating mass percent. From the use of these data, purity for three cationic lipids were found to be approximately 94.9 for DC-Chol, 100 for DOTMA, and 98.8 mass percent for DDAB. Most of the impurities that were found were at or below their LOQ values.

The purity for DOTAP and DOPE were found to be 100%, with no impurity peaks visible in the baseline.

These values compare favorably with the supplier's purity values, which are >98% for DC-Chol, and >99% for DOTAP, DDAB, DMTAP, and DOPE by TLC. The HPLC method offers a more accurate means of identifying and quantifying the impurities in a reagent, which is important if it is to be used in a pharmaceutical product.

Three commercially available and proprietary transfection agents were analyzed, and chromatograms are shown in Figures 6, 7, and 8. The

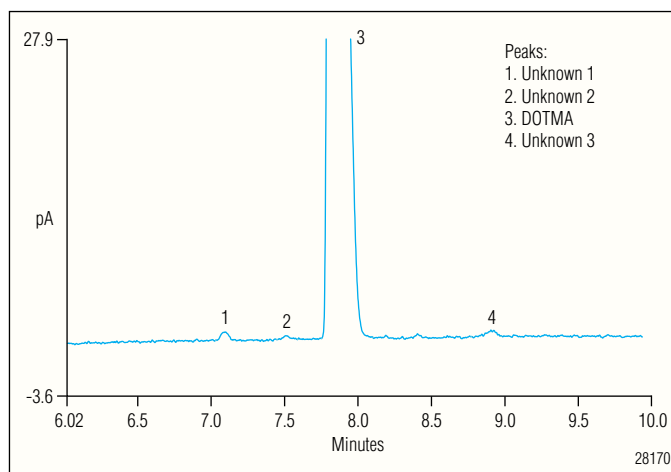

Figure 5. HPLC-CAD chromatogram of DOTMA 2000 ng o.c. and impurities.

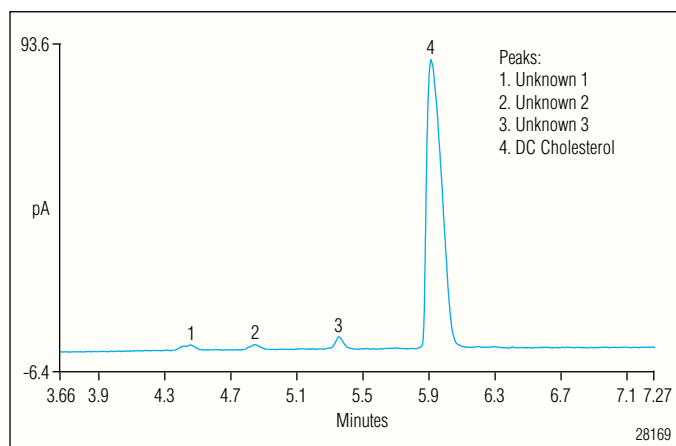

Figure 4. HPLC-CAD chromatogram of DC-Chol 2000 ng o.c. and impurities.

4 Analysis of Cationic Lipids Used as Transfection Agents for siRNA with Charged Aerosol Detection

individual components of the product are well resolved, and minor components and/or impurities are also detected.

A stability study was also performed using reversed-phase conditions (note different column and mobile phase). The chromatograms

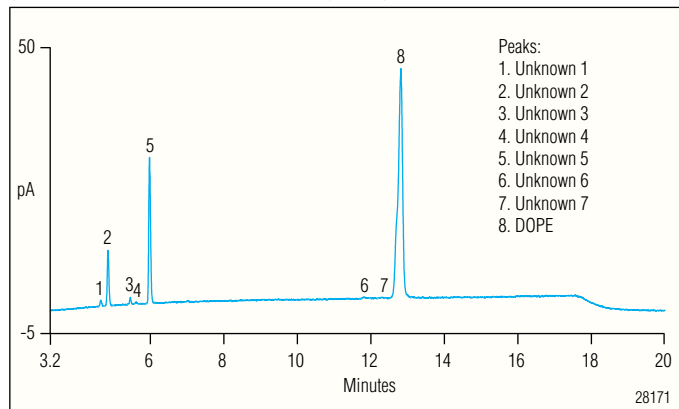

Figure 6. HPLC-CAD chromatogram of transfection agent A.

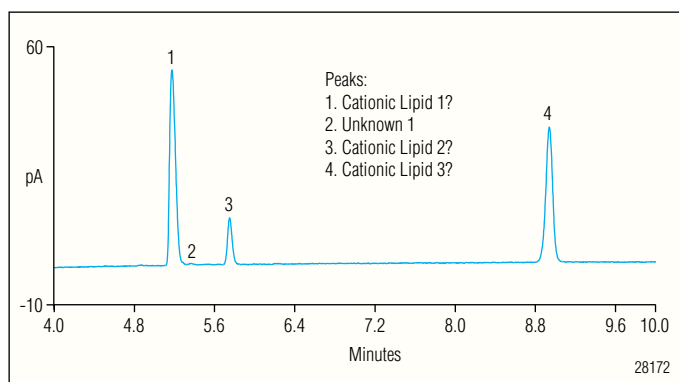

Figure 7. HPLC-CAD chromatogram of transfection agent B.

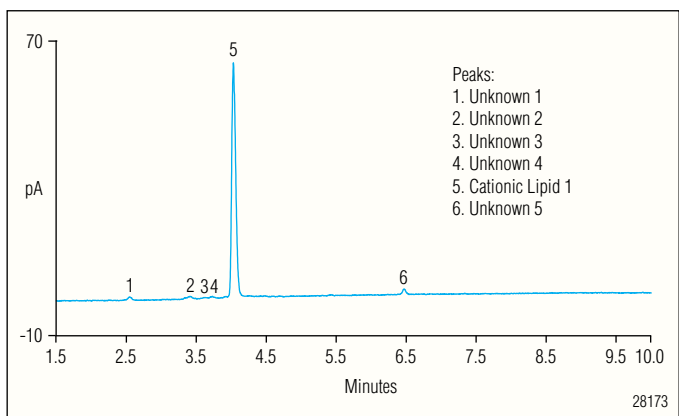

Figure 8. HPLC-CAD chromatogram of transfection agent C.

presented in Figure 9, show a transfection agent at day one and after eight days at ambient temperature. A degradant was formed, which eluted at 12.2 min.

The method is capable of determining the quantity and purity of many cationic lipid analytes without derivatization. With LOQ values at or

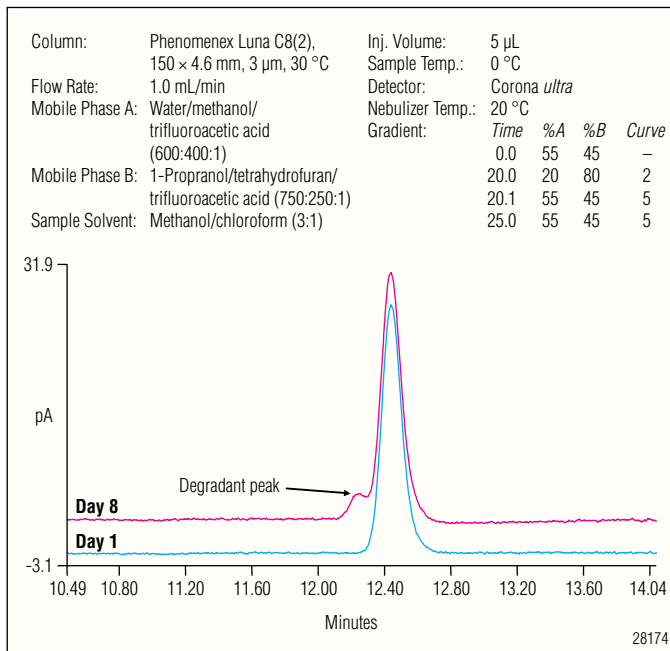

Figure 9. Overlaid HPLC-CAD chromatograms showing degradation of a cationic lipid product over eight days.

below 15 ng o.c., the sensitivity is improved at least 20-fold over methods using ELSD. This allows for accurate determinations of product impurities and with a wide dynamic range of three orders of magnitude, product purity and product content can also be determined from the same injection, reducing analysis time for a complete product analysis.

CONCLUSIONS

The Corona *ultra* detector provides high sensitivity and reproducibility, and a wide dynamic range that is required to analyze cationic lipids for both amount and purity. It is simpler to operate than a mass spectrometer, making routine analysis less costly and more reliable for both quality control and research and development analytical uses. This form of detection exceeds the capabilities of ELSD.

This method has the capacity to resolve the major cationic lipids that are used for transfection processes in the research and development of siRNA therapeutic agents. Three of the five cationic lipids analyzed had impurities which were detected, some at quantifiable levels.

Three commercially available transfection agents were analyzed, revealing their major components (both known and unknown) as well as possible impurities.

The method can also be used for stability analysis of cationic lipid formulations when evaluating products for storage conditions and useful lifetime. Impurity amounts were calculated based on parent analyte calibration curves, made possible by the relative uniformity of response of the charged aerosol detection method.

REFERENCES

1. Downward, J. RNA Interference. *British Medical Journal* **2004**, *328*, 1245–1248.
2. Pitkänen, L.; Ruponen, M.; Nieminen, J.; Urtti, A. Vitreous Is a Barrier in Nonviral Gene Transfer by Cationic Lipids and Polymers. *Pharm. Res.* **2003**, *4*, 576–583.
3. Narang, A.; Thoma, L.; Miller, D.; Mahato, R. Cationic Lipids with Increased DNA Binding Affinity for Nonviral Gene Transfer in Dividing and Nondividing Cells. *Bioconjugate Chem.*, **2005**, *16*, 156–168.
4. *Polymeric Biomaterials: Second Edition*, Severian Dumitriu (Ed.) **2002**, p. 813.
5. Zhong, Z.; Ji, Q.; Zhang, J. A. Analysis of Cationic Liposomes by Reversed-Phase HPLC with Evaporative Light-Scattering Detection. *J. Pharm Biomed Anal.* **2010**, *51* (4) 947–51.
6. ESA, A Dionex Corporation. Corona *ultra* for UHPLC, Response Consistency. <http://coronaultra.com/response.html> (accessed Apr 13, 2011).
7. Dionex Corporation. Improving the Quantitation of Unknown Trace Impurity Analysis of Active Pharmaceutical Ingredients. <http://www.dionex.com/en-us/webdocs/85802-PO-IICS-Trace-Impurity-API-HPLC-CAD-15Oct2010-LPN-2604-01.pdf> (accessed Apr 13, 2011).

ultra is a trademark and CAD, Corona, and UltiMate are registered trademarks of Dionex Corporation. Fused-Core is a registered trademark of Advanced Materials Technology.

Speed · Simplicity · Solutions



Dionex Corporation

1228 Titan Way
P.O. Box 3603
Sunnyvale, CA
94088-3603
(408) 737-0700

North America

U.S./Canada (847) 295-7500

South America

Brazil (55) 11 3731 5140

Europe

Austria (43) 1 616 51 25 Benelux (31) 20 683 9768 (32) 3 353 4294
Denmark (45) 36 36 90 90 France (33) 1 39 30 01 10 Germany (49) 6126 991 0
Ireland (353) 1 644 0064 Italy (39) 02 51 62 1267 Sweden (46) 8 473 3380
Switzerland (41) 62 205 9966 United Kingdom (44) 1276 691722

Asia Pacific

Australia (61) 2 9420 5233 China (852) 2428 3282 India (91) 22 2764 2735
Japan (81) 6 6885 1213 Korea (82) 2 2653 2580 Singapore (65) 6289 1190
Taiwan (886) 2 8751 6655

www.dionex.com



LPN 2828-01 06/11
©2011 Dionex Corporation