

Mycotoxins

# Sample Preparation and Analysis



SOLUTIONS BY



## Mycotoxins

### Sample Preparation and Analysis

Precise, simple and fast with LCTech products

Cultivation and storage of food and animal feed may contribute to the spread of moulds, which produce mycotoxins – toxic secondary metabolites. Their consumption can lead to serious health damage in both humans and animals.

Since 1998, LCTech GmbH, based in Obertaufkirchen, Germany, has been developing and supplying products and methods for the preparation and analysis of food, animal feed and environmental samples.

The product range includes semi and fully automated sample preparation systems as well as consumables utilised in the analysis of contaminants and residues.

Worldwide, many customers – including governmental and contract laboratories focusing on food and feed analysis, and also those based in the pharmaceutical industry or research – are equally appreciative of both the modern and efficient products and the responsive and competent customer support.

You're welcome to contact us for any support you may need.

Yours sincerely, Team LCTech

LCTech GmbH  
Daimlerstr. 4  
84419 Obertaufkirchen  
Germany

Tel: +49 8082 2717-0  
Fax: +49 8082 2717-100  
E-mail: [mycotoxins@LCTech.de](mailto:mycotoxins@LCTech.de)  
Web: [www.LCTech.de](http://www.LCTech.de)

*"Our goal is to provide an extensive support to our customers with outstanding products and competent consulting".*

Dr. Frederik Wuppermann, Head of Laboratory Biotechnology



	<b>Clean-up Columns</b>	<b>4</b>
	<b>ELISA Kit</b>	<b>14</b>
	<b>Accessories</b>	<b>15</b>
	<b>Photochemical Derivatisation</b>	<b>16</b>
	<b>Post-Column Derivatisation</b>	<b>17</b>
	<b>Vacuum Manifold</b>	<b>18</b>
	<b>Automated Sample Preparation</b>	<b>19</b>

# Clean-up Columns for the Mycotoxin Analysis

## Quality and Diversity



### Fast and efficient sample clean-up

The LCTech columns are based on immunoaffinity (DOnEX on SPE) and are suitable for the clean-up of food and feed samples ready for subsequent analysis.

High maximum loading capacities enable a remarkable variety of applications, from baby food to feed. The used antibodies show a high specificity against the respective mycotoxin. The chromatographic results are excellent without interfering signals and achieve very high recovery rates – even in the most difficult samples.

The immunoaffinity columns are successfully employed for the most diverse matrices in accredited laboratories worldwide. These columns performed well in international interlaboratory trials.

Different column formats offer higher flexibility and optimise sample preparation in the laboratory:

The standard columns convince with a long shelf life of 24 months. In addition, some of the clean-up columns are available as an inexpensive version (Select type) in a 1 mL and 3 mL format. These can be stored refrigerated and have a shelf life of 9 months.

SMART clean-up columns are incredibly small. These 3 cm immunoaffinity columns are AOAC compliant. Their use results in markedly reduced solvent consumption and processing time.

Since LCTech produces both antibodies and clean-up columns, comprehensive quality testing throughout the entire manufacturing process ensures high product quality.

All clean-up columns are suitable for automated processing and are useful, for example, in the LCTech devices FREESTYLE SPE, FREESTYLE ThermELUTE™ or AcceCLEAN.



### In Short, LCTech Clean-Up Columns:

- » High loading capacity
- » Guaranteed high recovery rates
- » Long shelf life of up to 24 months
- » Storage also at room temperature
- » Different formats: 1 mL, 3 mL and SMART columns
- » Detailed protocols for processing of various samples are available.
- » Competent, free-of-charge application support
- » Packs of 25 pieces or of 500 pieces for bulk purchases. SMART columns available in packs of 100 or 1000 pieces.
- » For particularly large sample volumes, suitable sample containers can be provided.



*LCTech meets the high demands of European and international legal requirements concerning mycotoxin analysis and controls every single production step. A detailed quality certificate is included in each pack.*

# AflaCLEAN M1 Select and AflaCLEAN M1 SMART Immunoaffinity Columns for Clean-up of Aflatoxin M1

Recovery rates (%) of aflatoxin M1 in different matrices, cleaned-up with LCTech's immunoaffinity columns AflaCLEAN M1 Select and AflaCLEAN M1 SMART.

	<b>AflaCLEAN M1 Select</b>	<b>AflaCLEAN M1 SMART</b>
<b>Matrix</b>	<b>Aflatoxin M1</b>	<b>Aflatoxin M1</b>
Milk	103	96
Raw milk	104	90
Milk powder	104	98

## Aflatoxine M1

### AflaCLEAN M1 Select and AflaCLEAN M1 SMART, Immunoaffinity Columns

Shelf life refrigerated at 4 to 8° C

AflaCLEAN M1 Select: 12 months from date of production

AflaCLEAN M1 SMART: 9 months from date of production

Loading capacity: 100 ng aflatoxin M1

Recoveries: AflaCLEAN M1 Select: M1 > 90 %

AflaCLEAN M1 SMART: M1 > 80 %

<b>3 mL Format</b>	<b>25 Pcs.</b>	<b>P/N 14202</b>
	<b>500 Pcs.</b>	<b>P/N 14201</b>
<b>SMART Format</b>	<b>100 Pcs.</b>	<b>P/N 14246</b>
	<b>1000 Pcs.</b>	<b>P/N 14248</b>

Aflatoxin M1 is a derivative of aflatoxin B1, which is taken up by animals via food and then converted into aflatoxin M1. It can be primarily found in milk and dairy products.

The quality of the AflaCLEAN M1 Select and AflaCLEAN M1 SMART columns is so high that even in difficult matrices, e.g. baby food, excellent results can be achieved.

Select columns are available in a 3 mL format and are suitable for manual as well as for automated processing with the LCTech devices AcceCLEAN and FREESTYLE SPE.

### Would you like it a little faster?

To speed up processing, the SMART format of the immunoaffinity columns is a good option. With a sample processing time of less than 20 minutes, the total processing time is significantly reduced in comparison to the time needed using 3 mL column at the same toxin concentration. In addition, over 80 % of the required solvents can be saved.

Clean-up with AflaCLEAN M1 SMART can be done manually or automated. In combination with the robotic system FREESTYLE ThermELUTE™, fully automatic processing of the samples from extract to chromatogram is possible together with excellent recovery rates and high sample throughput.

*More about the robotic system FREESTYLE ThermELUTE™ from page 20.*

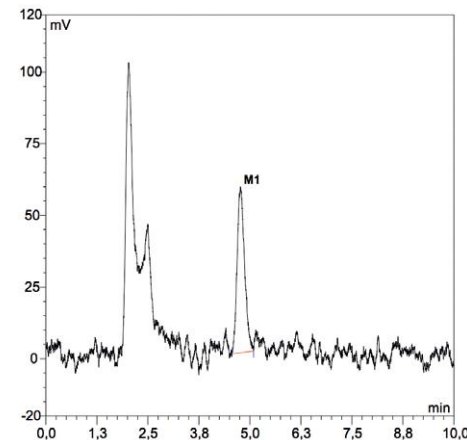

*10 mL milk, loaded on AflaCLEAN M1 SMART, spiked with 0.8 ng aflatoxin M1 (represents 80 ppt)*



## AflaCLEAN and AflaCLEAN Select

### Immunoaffinity Columns for the Aflatoxins B1, B2, G1 and G2

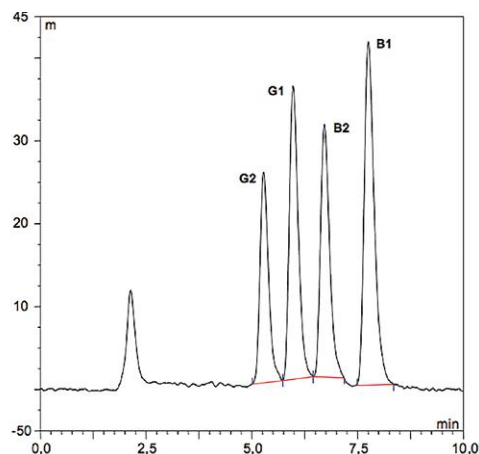

*Peanuts, spiked with 10 ppb aflatoxin cleaned-up with AflaCLEAN*

The immunoaffinity columns AflaCLEAN and AflaCLEAN Select are suitable for sample preparation in aflatoxin analysis using HPLC with fluorescence detection or LC-MS. They are designed for the clean-up of aflatoxins B1, B2, G1 and G2 in food and feed.

The columns possess a very high matrix tolerance and are able to bind aflatoxins with a very high specificity.

With only three provided extraction protocols, all matrices from A, for apricot, to Z for zest, can be tested whilst obtaining excellent recovery rates.

The columns are available in a convenient 3 mL polypropylene format. AflaCLEAN Select columns are also available in a 1 mL format.

Special advantages of AflaCLEAN columns include their shelf life of 24 months from the date of manufacture, and storage at room temperature without compromising quality.

The AflaCLEAN Select column is attractive for high sample throughput because of its markedly lower price, yet maintaining the same performance and high sample throughput. Shelf life is 9 months under cool conditions.

Both column formats are suitable for automated processing.

Recovery rates (%) of aflatoxins in different matrices, cleaned-up with LCTech's 3 mL immunoaffinity columns AflaCLEAN (1) and AflaCLEAN Select (2) – analysed with an HPLC/FLD system and LCTech's post-column derivatisation system UVE.

Matrix	B1	B2	G1	G2
Pepper (1)	91	105	99	99
Rice (1)	103	104	104	88
Peanuts (2)	101	97	105	88
Wheat (2)	97	98	98	84

#### Aflatoxins B1, B2, G1 and G2

##### AflaCLEAN Immunoaffinity Columns

Shelf life: 24 months at room temperature between 4 and 30 °C

Loading capacity: 150 ng Aflatoxin B1

Recoveries: B1 > 90 %, B2 > 80 %, G1 > 90 %, G2 > 60 %

3 mL Format	25 Pcs.	P/N 10514
	500 Pcs.	P/N 11721

##### AflaCLEAN Select Immunoaffinity Columns

Shelf life: 9 months cooled at 4 to 8 °C

Loading capacity: 200 ng Aflatoxin B1

Recoveries: B1 > 90 %, B2 > 80 %, G1 > 90 %, G2 > 60 %

1 mL Format	25 Pcs.	P/N 12062
	500 Pcs.	P/N 12063

3 mL Format	25 Pcs.	P/N 12058
	500 Pcs.	P/N 12059



# Immunoaffinity Column AflaCLEAN SMART

## Small + Fast + Economical = SMART

Recovery rates (%) of aflatoxins B1, B2, G1, and G2 in different matrices, cleaned-up with LCTech's 3 mL immunoaffinity columns AflaCLEAN SMART.

The samples were spiked with 10 ppb total aflatoxin respectively.

Matrix	B1	B2	G1	G2
Chili	82	87	83	85
Cereal	101	95	100	85
Hazelnut	104	98	101	83
Pistachio	99	94	95	81

All SMART columns of LCTech are compatible with common 10 mL syringes for the sample application or 1 mL syringes for elution.

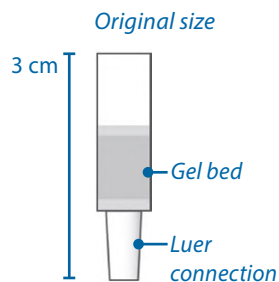

### Aflatoxins B1, B2, G1 and G2

#### AflaCLEAN SMART, Immunoaffinity Columns

Shelf life: 9 months cooled at 4 to 8 °C

Loading capacity: 100 ng Aflatoxin B1

Recoveries: B1 > 90 %, B2 > 80 %, G1 > 90 %, G2 > 60 %

SMART Format	100 Pcs.	P/N 12862
	1000 Pcs.	P/N 12863

These interesting AflaCLEAN SMART immunoaffinity columns for aflatoxins B1, B2, G1 and G2 convince not only by their small size and low price, but also through reduced solvent usage, shorter processing time and very good recovery rates.

Like their bigger siblings AflaCLEAN and AflaCLEAN Select, these are suited for clean-up of samples for subsequent aflatoxin analysis. With a loading capacity of 100 ng, they are AOAC compliant.

With their use in extraction, dilution, rinsing, sample loading and elution, more than 80 % of the solvents can be saved.

Processing time is also reduced in key steps of the clean-up procedure when using AflaCLEAN SMART. For example, emptying of the column is not necessary and sample loading and washing of the column only takes 4 minutes at the most with a 10 mL sample volume and a flow rate of 3 mL/min. Since a maximum of only 400 µL are used for elution, processing time will be reduced even further.

Clean-up with AflaCLEAN SMART can be done either manually or automatically with the robotic system FREESTYLE ThermELUTE™.

*More about the robotic system FREESTYLE ThermELUTE™ from page 20.*

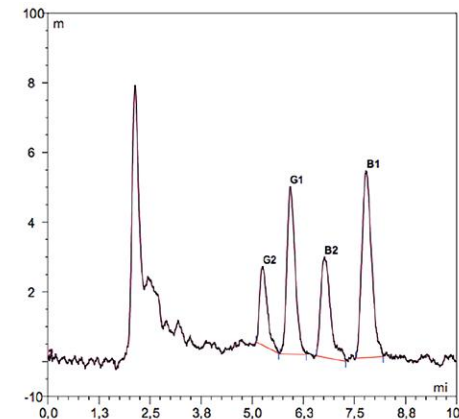

*Chili, spiked with 10 ppb total aflatoxin respectively, cleaned-up with AflaCLEAN SMART*



# Immunoaffinity Column

## Sample Preparation for the Analysis of Ochratoxin A



LCTech developed the OtaCLEANimmunoaffinity column for sample preparation in routine analysis using HPLC with fluorescence detection or LC-MS. It has been designed for the purification of ochratoxin A in food and feed and achieves very good recovery rates in difficult matrices.

The column possesses a very high matrix tolerance and is able to bind ochratoxin A highly specific. The matrix interferences can be largely separated. Thus, e.g. all types of coffee can be tested without prior SPE clean-up.

The columns are available in the 1 mL format or in the convenient 3 mL format and are suitable for manual or automated processing.

Another advantage of the OtaCLEANcolumn is its long shelf life of 24 months from the date of manufacture even when stored at room temperature without compromising its high quality.

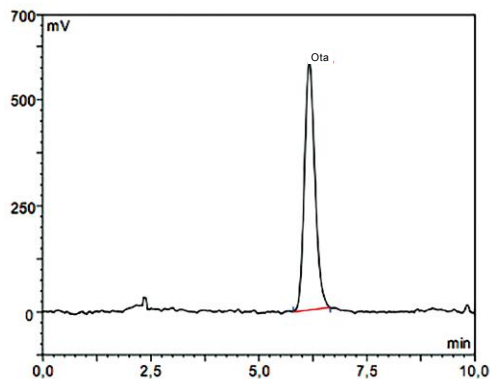

*Roasted Coffee, spiked with 5 ppb ochratoxin A, cleaned-up with OtaCLEAN*



Recovery rates (%) of ochratoxin A in different matrices, cleaned-up with LCTech's 3 mL immunoaffinity columns OtaCLEAN and analysed with an HPLC/FLD system. The samples were spiked with 10 ppb total ochratoxin A respectively.

Matrix	OTA
Beer	96
Cacao	92
Coffee	100
Durum wheat	92

### Ochratoxin A

#### OtaCLEAN, Immunoaffinity Columns

Shelf life: 24 months at room temperature between 4 and 30 °C

Loading capacity: 200 ng Ochratoxin A

Recoveries: > 90 %

1 mL Format	25 Pcs.	P/N 12425
	500 Pcs.	P/N 12427
3 mL Format	25 Pcs.	P/N 10515
	500 Pcs.	P/N 11535



# Fast, faster, SMART Immunoaffinity Column OtaCLEAN SMART

Recovery rates (%) of ochratoxin A in different matrices, cleaned-up with LCTech's immunoaffinity columns OtaCLEAN SMART. The samples were spiked with 4-10 ppb ochratoxin A.

Matrix	OTA
Corn	101
Instant coffee	97
Red wine	92
Rice	104

## Ochratoxin A

### OtaCLEAN SMART, Immunoaffinity Columns

Shelf life: 9 months cooled at 4 to 8 °C  
 Loading capacity: 100 ng Ochratoxin A  
 Recoveries: > 80 %

SMART Format	100 Pcs.	P/N 13346
	1000 Pcs.	P/N 13351

The challenge many laboratories have to face nowadays is to be able to process many samples as quickly as possible. To facilitate this task, LCTech has developed the OtaCLEAN SMART immunoaffinity column for the analysis of ochratoxin A in food.

Like the other LCTech SMART columns, the operating mechanism is based on the principle of immunoaffinity chromatography with increased flow rates and a customized, small elution volume in order to shorten the processing time.

The material in the column is coated with antibodies targeting ochratoxin A. When loading the sample extract onto the column, ochratoxin A is retained in the column, while the matrix components pass through the column. After a rinsing step, ochratoxin A can be quantitatively eluted from the column with methanol and then be measured.

The shelf life is up to 9 months from date of manufacture if stored refrigerated.

Clean-up with OtaCLEAN SMART can be done either manually or automatically with the robotic system FREESTYLE ThermELUTE™.

*More about the robotic system FREESTYLE ThermELUTE™ from page 20.*

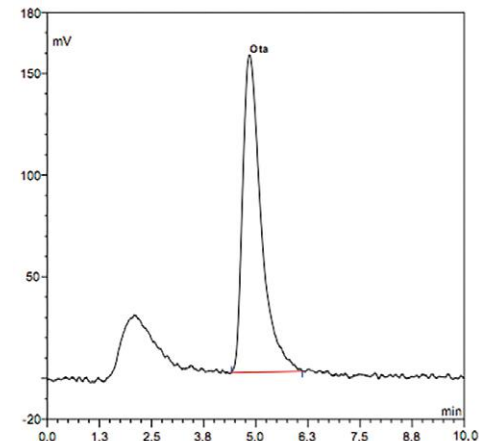

*Corn, spiked with 10 ppb ochratoxin A, loaded onto OtaCLEAN SMART*



# Combined Immunoaffinity Column Afla-OtaCLEAN

## One for All

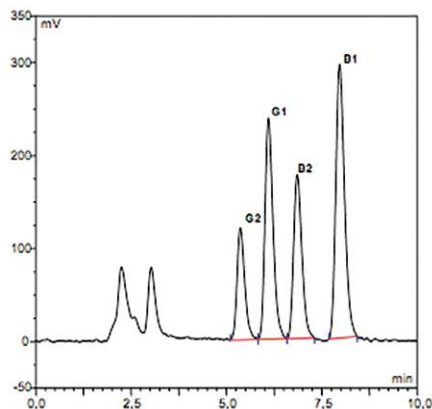

Aflatoxins and ochratoxin A are produced by fungi in wet storage. They are often found together in many foods and feeds. In order to reduce the workload and to halve the working time, a way of testing several mycotoxins in one single operation was needed.

For this reason, LCTech has developed the combined immunoaffinity column Afla-OtaCLEAN for the clean-up of aflatoxin B1, B2, G1, G2 and ochratoxin A.

These columns are available in a convenient 3 mL polypropylene format, can be processed automatically and have a shelf life of 18 months from date of manufacture at room temperature.

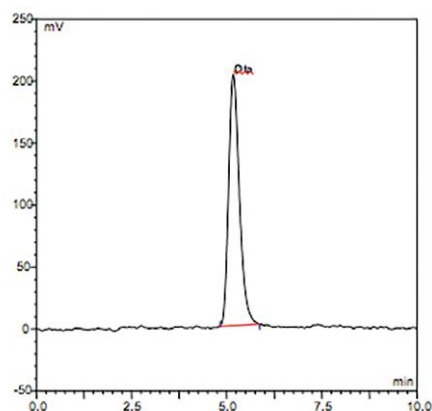

### SMART combined

The immunoaffinity columns AflaCLEAN SMART and OtaCLEAN SMART can also be combined. Just stack the two columns and they will be instantly ready for the manual clean-up of aflatoxins B1, B2, G1, G2 and ochratoxin A.

Rice, spiked with 10 ppb aflatoxin (B/G) and 10 ppb ochratoxin A, cleaned-up with Afla-OtaCLEAN



Recovery rates (%) of aflatoxins and ochratoxin A in different matrices, cleaned-up with LCTech's immunoaffinity column Afla-OtaCLEAN.

Matrix	B1	B2	G1	G2	OTA
Rice	99	98	97	81	97
Raisins	99	98	94	69	97
Corn	99	93	98	85	98
Pepper (black)	93	91	97	78	95

### Aflatoxins B1, B2, G1, G2 and Ochratoxin A

#### Combination Column – Fast Clean-up in Tandem

Aflatoxins and ochratoxin A often occur together and are therefore jointly analysed. The combination column Afla-OtaCLEAN makes your work much easier by cleaning the extract within one processing step.

#### Afla-OtaCLEAN, Immunoaffinity Columns

Shelf life: 18 months at room temperature between 4 and 30 °C

Capacity Aflatoxin B1: 150 ng Aflatoxin B1

Capacity Ochratoxin A: 200 ng Ochratoxin A

Recoveries: Aflatoxin B1 > 90 %, B2 > 80 %, G1 > 90 %, G2 > 60 %, Ochratoxin A > 90 %

3 mL Format	25 Pcs.	P/N 11022
	500 Pcs.	P/N 11771

# SPE Clean-up Columns for the Deoxynivalenol Analysis

Recovery rates (%) of deoxynivalenol in different matrices, cleaned-up with LCTech's clean-up column DONeX.

Matrix	DON
Bread	108
Chicken feed	101
Pasta (dry)	105
Wheat	100

## Deoxynivalenol (DON)

**DONeX, SPE Column for the DON-Analysis**  
No special requirements for storage

3 mL Format	25 Pcs.	P/N 12792
	500 Pcs.	P/N 12793

Deoxynivalenol, also known as vomitoxin, is a metabolic product of various fungi of the genus *Fusarium* (*F. culmorum*, *F. graminearum*) that occurs predominantly on cereals (wheat, barley, oats).

As a rule, this toxin is analysed with an HPLC / UV detector or alternatively with HPLC / post-column derivatisation and fluorescence detector or with LC/ MS. In all three processes, thorough sample preparation increases the service life of the analytical system and also the life of the HPLC column. In addition, pre-cleaning helps reduce interferences through matrix components and nearly halves the chromatography time of the HPLC system.

The DONeX clean-up column developed by LCTech excludes matrix interferences and herewith related long chromatographies with interfering matrix peaks. This results in better and faster chromatograms as well as in a higher measuring sensitivity.

The DONeX column is suitable for many common matrices such as corn, barley, oats, wheat, rye, cereal-based feed, but also for more complex matrices such as cereals, pasta or breads.

DONeX is used with a maximum load of 4 g for HPLC / post-column derivatisation and fluorescence detector or also for LC / MS. Owing to the high matrix load, users of an HPLC system / UV detector achieve reliably low detection limits and chromatograms that are easy to evaluate.

The clean-up column is available in a 3 mL format and is thus suitable for automated processing in the LCTech systems AcceCLEAN and FRESYLE SPE.

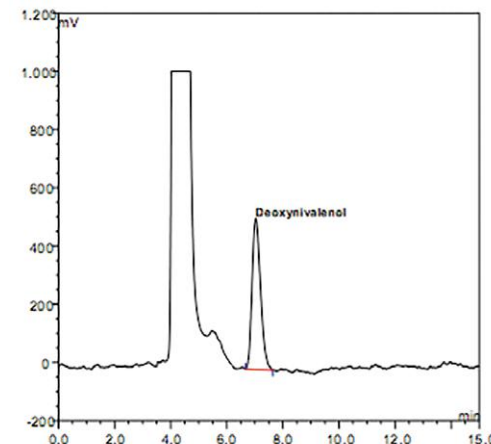

*Wheat, spiked with 1 ppm, extracted and cleaned-up, analysed with post-column derivatisation and fluorescence detector.*

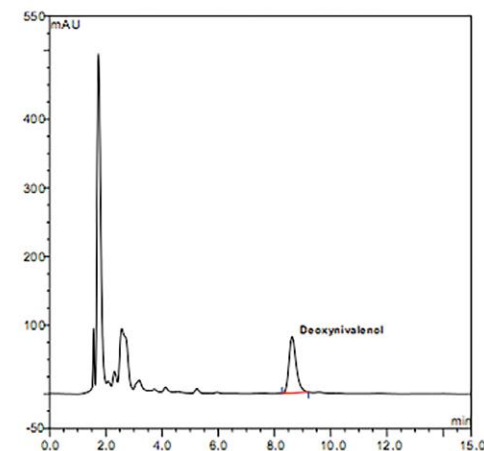

*Pasta, spiked with 1 ppm, analysed with UV detection.*



## Vitamin Analysis

### Affinity Column BioteX for Biotin / Vitamin B7 Analysis

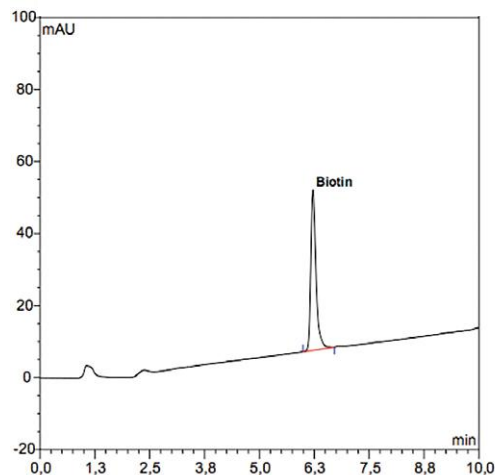

*Vitamin tablets extracted (1 µg biotin is loaded onto the affinity column BioteX)*

Biotin is a naturally occurring vitamin that belongs to the family of B vitamins (B7) and is one of the water-soluble vitamins. It can be found ubiquitously in many foods. The biotin concentration supports a vitamin-rich diet and is consequently found in many vitamin drinks, vitamin tablets or food supplements. Egg yolk, soybeans and liver are amongst the foods that are high in biotin content.

The BioteX affinity columns facilitate a high sample throughput and parallel sample preparation in food analysis via UV-determination or in HPLC or LC-MS analysis.

The affinity columns are available in the 3 mL polypropylene format and can be stored refrigerated for 9 months from the date of manufacture. Just like the other affinity columns, the BioteX column is also suitable for automated processing.

Recovery rate (%) of biotin in different matrices, cleaned-up with LCTech's affinity column BioteX.

Matrix	Biotin
Vitamin tablets	90
Nutritional yeast and biotin	102
Vitamin powder	91
Biotin containing food supplement	94

#### Biotin / Vitamin B7

##### BioteX, Affinity Columns

for biotin/vitamin B7 analysis

Shelf life: 9 months cooled at 4 to 8 °C

Loading capacity: 1000 ng Biotin

Recoveries: Biotin > 90 %

3 mL Format	25 Pcs.	P/N 14100
	500 Pcs.	P/N 14101



## Another Case for the Matrix of the Month

### Tricky Matrix?

No matter what – raisins, drinking chocolate or peanut flips, aflatoxin B1, B2, G1, G2, M1 or ochratoxin A, whether manual or automated processing, we will find a solution!

As time passes, our laboratory has collected a lot of specific knowledge about sample preparation and analysis of mycotoxins in diverse matrices.

Why should we keep this expert knowledge as a secret? To share it with you we present chromatograms and recovery rates monthly on our website.

Learn more about the variety of already analysed applications and visit [www.LCTech.de](http://www.LCTech.de).

Do you also have a special matrix that we should test for mycotoxins? Please let us know and write an e-mail to [mycotoxins@LCTech.de](mailto:mycotoxins@LCTech.de)



## ELISA Rapid Test ErgoREAD

### Simple, Fast and Inexpensive Screening of Ergot Alkaloids

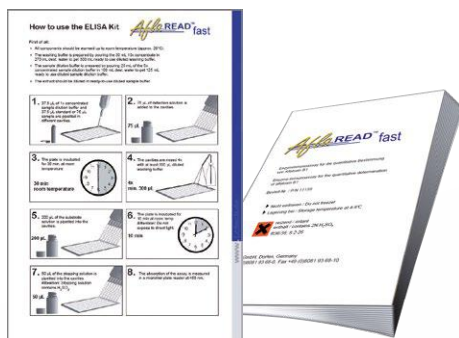

An extensive manual together with a set of descriptive brief instructions lead through the detection with the ELISA rapid test.

Ergot alkaloids are naturally occurring mycotoxins. These are fungi of the genus *Claviceps* that arise in a variety of grain and flour products as primary contamination and have highly toxic properties.

Poisoning by ergot alkaloids is called ergotism (erysipelas) or St. Anthony's fire, which is also known as ignis sacer - „holy fire“. The first known ergotism epidemic happened in 857 and many more followed with countless deaths. Even today, harmful alkaloids are found in food and feed.

#### Simple rapid test for the qualitative analysis of ergot alkaloids in wheat, rye and triticale

The ErgoREAD rapid test is ready-to-use: It contains a 96-well ELISA plate; it can also be used individually in 8-well strips. All required reagents and standard solutions are included. An extensive manual together with a set of descriptive brief instructions lead even inexperienced lab staff safely through the uncomplicated application.



#### In Short, ErgoREAD:

- » Complete, low-cost rapid tests
- » Only two extraction methods for solid samples
- » Best reproducibility and repeatability through standardisation
- » Reacts with "-ines" as well as with "-inines"
- » Easy-to-understand software at no charge
- » Broad measuring range
- » Satisfactory recovery rate: 80 - 110 %

#### Ergot Alkaloids

ELISA Kit, 96-well plate  
Especially for rye and wheat

ELISA Kit, 96-well plate

P/N 13344

Direct comparison between measurements with LC-MS/MS and ELISA rapid test ErgoREAD

Sample	LC-MS/MS ( $\Sigma$ Ergot alkaloids)	ELISA ErgoREAD ( $\Sigma$ Ergot alkaloids)
Wheat*	1.68 $\mu\text{g/g}$	1.89 $\mu\text{g/g}$
Rye*	0.57 $\mu\text{g/g}$	0.48 $\mu\text{g/g}$
Triticale	2.41 $\mu\text{g/g}$	2.46 $\mu\text{g/g}$

\*Data provided by BAM Federal Institute for Materials Research and Testing

## Accessories for the Mycotoxin Analysis

### Coordinated Analysis from a Single Source

#### Mycotoxin Analysis

##### Photometer

with 450 nm filter, also mobile use on-site

Photometer	P/N 11689
------------	-----------

##### HPLC column

for the analysis of aflatoxins and ochratoxin A

HPLC column	RP C18	P/N 10522
Guard column	RP C18 3 Pcs. / Package	P/N 10523
Guard column holder		P/N 10750

##### Sample reservoirs

for large sample volumes, made of DURAN glass, reusable and dishwasher proof

2 Pcs. / Package	P/N 10896
------------------	-----------

##### Selected HPLC column for the processing of aflatoxin B1, B2, G1, G2 and ochratoxin A

This HPLC column by LCTech satisfies through short processing times and a great price. A guaranteed theoretical plate number of at least 120,000 ensures good base-line separation with short running times – aflatoxin B1 already elutes in less than 8 minutes. Due to the short processing time, the consumption of eluents is also reduced. Thus, by use of this HPLC column you make in fact a double saving.

##### Portable photometer for fast results

For an instant and easy reading of the ELISA rapid test results, we recommend the battery-powered, robust and portable LCTech photometer. The photometer is suitable for diverse applications in the analysis of water, food and feed providing the result within a few seconds.

Having a 450 nm filter added by default, further filters are available and can easily be exchanged. Different holders for well strips and cuvettes provide flexibility for the sample reservoir.

Right from the start handling is very easy and intuitive. A LCD display and two control buttons – that's all you need to navigate the menu, make a choice or define parameters.

##### Sample reservoirs for large volumes

The 100 mL sample reservoirs are used for the collection of the sample and are suitable for all LCTech stands like e.g. the vacuum manifold EluVac. The sample reservoirs are suitable for all kinds of 3 mL SPE cartridges. They can be combined with both the LCTech immunoaffinity columns and the Florisil columns.

LCTech sample reservoirs are made of DURAN glass, lab washer-proof and reusable. The reservoirs are delivered with screwing and PTFE seals.

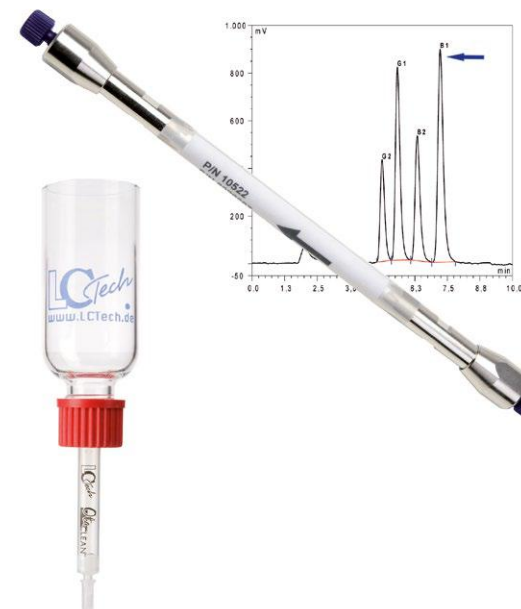

# UVE Photochemical Derivatisation

## Easy and Effective

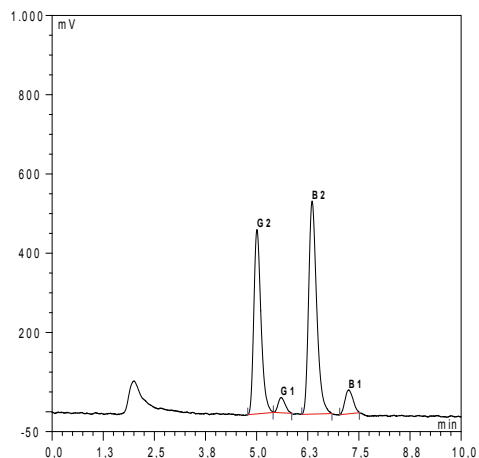

Without UVE

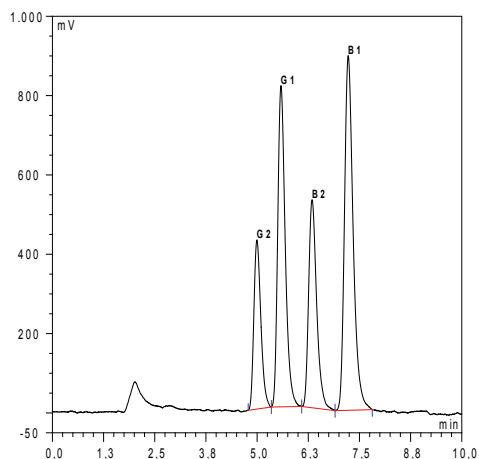

With UVE: high intensity of the signals

### Photochemical reactor for the derivatisation of aflatoxins with UV light

Due to the low aflatoxins limits in food and low inherent fluorescence of aflatoxins B1 and G1, aflatoxin analysis needs to be optimised through derivatisation. This is done photochemically with the UVE under UV light radiation at 254 nm. Aflatoxins B1 and G1 are thereby hydroxylated and can then be measured through fluorescence spectrometry. The sensitivity of the measurement increases considerably.

Key advantage of using UVE over electrochemical bromination: the water, present in the eluent, is used as the reagent, hence neither iodine nor  $\text{HNO}_3$  /  $\text{KBr}$  are required. In addition, the detector will not be contaminated and no variation in derivatisation will occur.

This method is accepted by the AOAC, has been used successfully in collaborative trials and is in use worldwide in accredited laboratories.

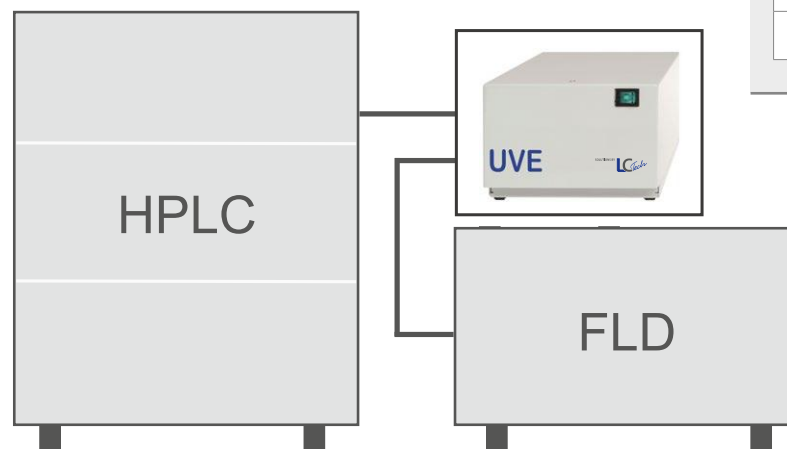

### In Short, LCTech UVE:

- » The UV lamp is designed for an operation of over several thousand hours.
- » No toxic reagents are necessary, because water is used as reagent.
- » Can be used with any HPLC.
- » The HPLC system stays clean and is immediately ready for other applications; no more complex rinsing required.
- » Easy Plug and Play installation: connect UVE with HPLC and detector, then turn on; the unit is ready for operation.
- » Compact device: 15 cm wide, 9 cm high, 27 cm deep
- » Various safety features
- » Low cost and maintenance
- » European CE certificate and DIN ISO certified

### UVE

#### Photochemical Reactor for the Analysis of Aflatoxins

220 - 265 VAC

P/N 10519

90 - 126 VAC

P/N 10742



# Post-Column Derivatisation with PICKERING

## For the Perfect Mycotoxin Analysis with HPLC

### In Short, Post-column Derivatisation with PICKERING

- » Significantly improved detection limit through derivatisation
- » Enhanced sensitivity
- » Pulse-free base line attributable to injection pump
- » Simple handling by less experienced lab staff
- » Low maintenance: no delicate wearing parts
- » Automated system rinsing
- » Chemically inert
- » Matrix insensitivity

### PINNACLE PCX

Professional system for post-column derivatisation

<b>Aflatoxins</b> , 1.4 mL reactor, single pump	<b>P/N 1153-1032</b>
<b>Ochratoxin A</b> , 0.5 mL reactor, single pump	<b>P/N 1153-1022</b>
<b>Fumonisins</b> , 0.15 mL reactor, single pump	<b>P/N 1153-1012</b>
<b>Trichothecene</b> , spec. reactor, dual pump	<b>P/N 1153-1072</b>

### The professional system: PINNACLE PCX

The PINNACLE PCX by PICKERING Laboratories is a professional system for post-column derivatisation within the mycotoxin analysis.

Substances that are not or only barely visible for the detector react after separation with a reagent. Thereby the detection sensitivity is significantly increased.

This method is suitable for the detection of aflatoxins, fumonisins, ochratoxin A and deoxynivalenol.

### What happens during derivatisation?

**Aflatoxins B1 and G1** are transformed to stable fluorescent derivatives using an aqueous iodine solution.

An alkaline shift of the pH increases the fluorescence of **ochratoxin A** significantly.

**Fumonisins** are transformed into fluorescent isoindole derivatives by a complex reaction targeting their amine functions.

Formaldehyde is initially split off from **deoxynivalenol**, which is subsequently transformed to a fluorescent lutidine derivative.

### Broad range of applications

The PINNACLE PCX can be used with all common HPLC brands.

It can be easily adapted to every required application – by simple and fast exchange of the reactor and selection of the storable method via software.

Detailed protocols are available for the individual mycotoxins.

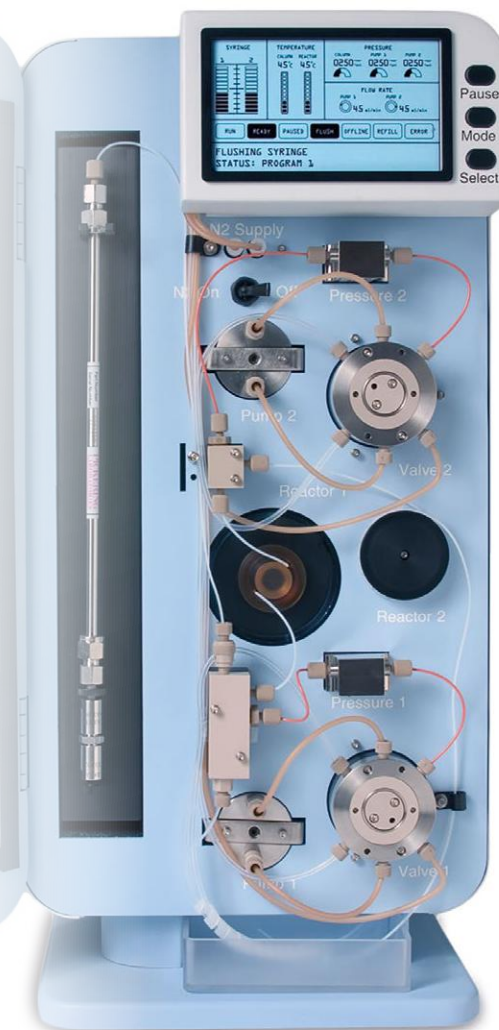

# Simultaneous Clean-up: Vacuum Manifold EluVac

## From Sample Loading to Elution – All in One



Vacuum Manifold EluVac by LCTech

### More samples in less time

The vacuum manifold EluVac allows the simultaneous clean-up of up to 20 samples under vacuum in preparation for mycotoxin analysis. Thus, sample throughput in the laboratory can be significantly increased with little effort.

### Flexible and adaptable

Effortless and quick, the EluVac can be adapted to various applications for solid phase extraction in environmental, food and feed analysis. For these purposes different containers for the collection of the eluates can be integrated into the system.

Another detail provides flexibility: Either a central 600 mL beaker or a pipe connected to an external reservoir can be used as a waste container. Thus EluVac is suitable for large sample volumes like water or milk samples.

### Comfortable handling

System operation of the EluVac is very easy. One big plus point: By simply turning the lid you can switch from "waste" to "collect" position without disassembling the device.

### In Short, LCTech EluVac

- » Valuable time and cost saving due to enhanced sample throughput
- » Robust and suitable for daily laboratory routine work
- » Suitable for all IAC column formats including SMART columns
- » Chemically resistant
- » For large sample volumes corresponding reservoirs are available.

### EluVac

System, sample rack and collection rack for 4 mL vials

<b>EluVac Vacuum Manifold Set</b>	<b>P/N 12415</b>
-----------------------------------	------------------

Further sets and racks on request

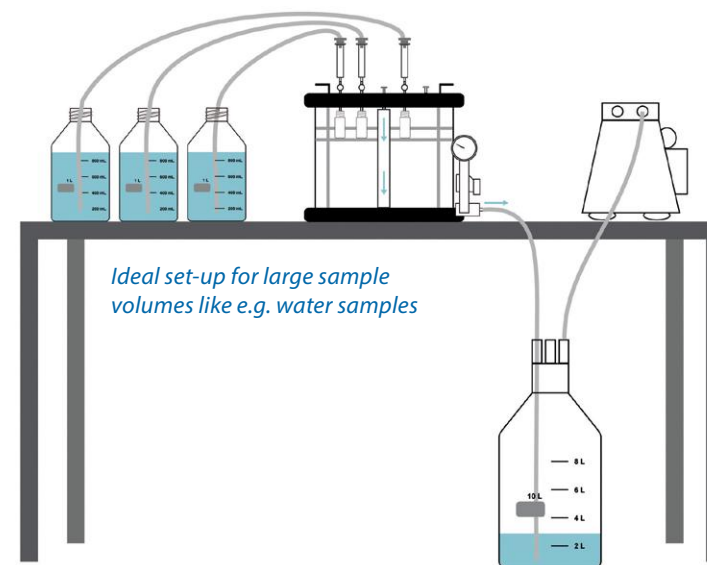

# Automated Sample Preparation with SPE and Immunoaffinity Columns

## Parallel - Fast - AcceCLEAN

### In Short, LCTech AcceCLEAN Compact:

- » Multiple increase of sample throughput
- » Highest recovery rates
- » Intuitive direct operation without PC
- » High-quality components for high precision
- » Robust, safe design
- » Pre-set methods for LCTech immunoaffinity columns

AcceCLEAN achieves the highest recovery rates, e.g. of ochratoxin A in peanut butter (with LCTech IAC column OtaCLEAN).

Manual Clean-up	94 %
Automated clean-up with AcceCLEAN	93 %

### AcceCLEAN

Automated system for IAC and SPE columns

AcceCLEAN	P/N 11020
-----------	-----------

Racks, accessories and installation on request

The sample preparation device AcceCLEAN cleans raw extracts automatically via SPE or immunoaffinity columns – fast and convenient for subsequent analysis.

This device is suitable for all laboratories where a multitude of SPE and immunoaffinity columns with a high throughput are processed. It deals with anything: PCBs in soil, furans in transformer oils, pesticides in fruit or mycotoxins in spices.

The AcceCLEAN handles up to three samples simultaneously and up to 30 samples in one run. Consequently, the device requires less than 45 minutes from loading of the columns to elution for three samples processed concurrently.

During the entire process, the columns are sealed with a lid. In that way, positive pressure ensures constant and reproducible flow rates. Due to the sophisticated fluidics and included rinsing steps, cross-contamination is reliably prevented.

The unit is compatible for the common column formats of different manufacturers in sizes of 1, 3 and 6 mL and suitable for all usual solvents. Seven different solvents can be used. The maximum sample volume is 27.5 mL.

Conditioning, emptying, loading, washing, drying and elution – these are the individual steps that can be combined flexibly and adapted to the method. Up to 50 methods may be stored in the system. For the LCTech IAC columns, complete methods for standard applications are already included.

Since the device is simple and intuitive to use and no complicated installation is required, it is immediately ready for use.



The racks can be loaded with great ease.



The columns remain sealed on the system - positive pressure ensures constant flow rates.

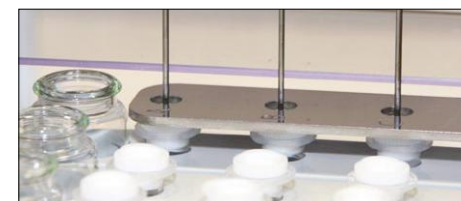

Three needles work on the columns in parallel. Three-fold sample throughput.



# Fully Automated Mycotoxin Analysis – Twenty-four-seven

## FREESTYLE ThermELUTE™



### Simple, reliable

FREESTYLE ThermELUTE™ facilitates fully automated mycotoxin analysis with such sensitive results that even baby food can be easily analysed. By means of a unique technique, the comprehensive automation „from raw extract to chromatogram“ is realised without manual intervention. The results are impressive:

- High sample throughput of up to 500 samples / week
- Sample processing day and night and even at weekends
- Remarkable sensitivity in the lower ppt range
- Excellent recovery rates
- Reproducible results

### The optimal combination

The system achieves the high sample throughput by using the SMART immunoaffinity columns. Through miniaturization of the overall process, not only the processing time of the sample is dramatically reduced, but also the required amounts of sample and solvent. Each sample is processed with a SMART column, which grants top performance for each sample and reliably prevents cross-contamination.

*We are delighted to advise you on automated sample preparation and will be pleased to send you comprehensive information on the FREESTYLE system.*

*Please request by e-mail: [info@LCTech.de](mailto:info@LCTech.de).*



Sample preparation with FREESTYLE

Analysis with any HPLC

Automatic  
sample injection

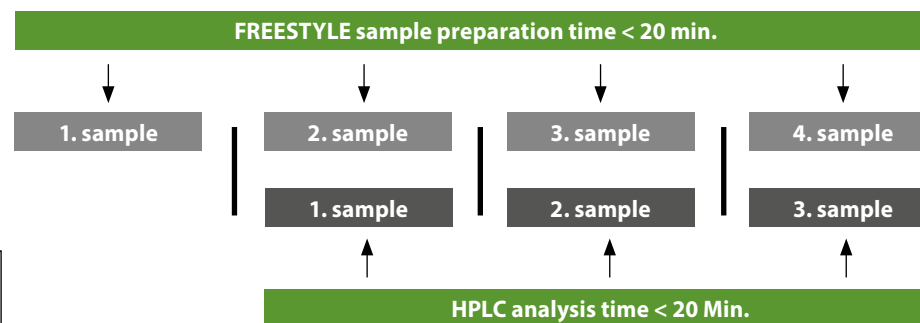

The FREESTYLE carries out sample preparation, during which the HPLC analyses the previously prepared sample. This happens fully automatic, round the clock. Thus, analysis throughput can be increased to more than 70 samples per day.

# Fully Automated from Raw Extract to Chromatogram

ppt instead of ppb



Recoveries (%) of aflatoxins B1, B2, G1, G2, M1 or Ochratoxin A; Samples processed with FREESTYLE ThermELUTE™						
Matrix	B1	B2	G1	G2	M1	OTA
Standard*	100	100	100	100	100	100
Raisins 10 ppb**	94	96	94	91		
Pistachios 10 ppb**	98	94	95	93		
Milk 0,02 ppb**					99	
Roasted Coffee 5 ppb**						90
Paprika noble sweet 10 ppb**						84
White Wine 0,8 ppb**						97

\* Standard is set = 100%

\*\* corrected with non-spiked sample

### No detours – the direct route is the fastest

The processing of samples takes place entirely on the FREESTYLE robotic system, which is equipped with the SPE and ThermELUTE™ modules and is also combined with an HPLC. Elution from the practical SMART immunoaffinity column is made directly into the HPLC.

### How it works – operation of FREESTYLE ThermELUTE™

Thermal denaturation breaks the toxin-antibody bond. The large-volume and aqueous elution with quantitative transfer is made directly into the HPLC sample loop. The HPLC takes up the sample and analyses it. Losses caused by evaporation or adsorption are excluded, sensitivity is increased enormously, to such extent that even in baby food approved limits can be reliably measured.

Per toxin, there is only one method for all regulated matrices. Mycotoxin analysis has never been easier!

For detailed information on LCTech SMART columns please see pages 5, 7 and 9.

# Automated Solid Phase Extraction

## SPE Can Be So Simple and Ingenious

### FREESTYLE SPE

The FREESTYLE robotic system with SPE module assumes routine laboratory tasks around the clock and even at weekends.

The system processes unattended, yet reliably, various applications for mycotoxin analysis.

### Unique

The most important element of the FREESTYLE SPE is the solid connection of the SPE column with the robotic arm affording free motility across the entire system. Hence, this allows for controlled pressurization and pressure controlled flow-rates during loading and eluting of the sample.

### Safe

When excessive pressure interrupts the processing of a sample, the unit will clean itself and continues with the next sample. Hence, long sample sequences can be worked through overnight. FREESTYLE will indicate unfinished samples in the sequence list.

### Versatile

All types of mycotoxin columns and SPE-standard formats (1, 3, 6, 8, 15 mL) can be automated on the FREESTYLE. The options for sample loading are as diverse as they are for elution. For convenience, even elution into a volumetric flask with 2 or 5 mL is possible, so that the eluted volume can be quickly adjusted to an exact value.

A selection of various racks facilitates elution into different containers, e.g. into a 2 mL or 5 mL volumetric flask, when a defined end volume is required.



*Do you want to automate sample preparation in your laboratory?  
We are happy to help. Just e-mail your queries and requirements to:  
[info@LCTech.de](mailto:info@LCTech.de).*

- AOAC Official Method 2000.08 Aflatoxin M1 in liquid milk Immunoaffinity column by liquid chromatography first action 2000.
- AOAC Official Method 2005.08, Aflatoxins in corn, raw peanuts and peanut butter.
- EC 165/2010 COMMISSION REGULATION (EU) No 165/2010 of 26 February 2010 amending Regulation (EC) No 1881/2006 setting maximum levels for certain contaminants in foodstuffs as regards aflatoxins.
- EN ISO 1450 European norm for extraction and analysis of aflatoxin M1 in milk and milk powder.
- FAPAS Proficiency Test 0490 Report, Aflatoxin analysis in pistachio, June - August 2006.
- FAPAS Proficiency Test 04148 Report, Aflatoxins B & G in maize, October - November 2009.
- K. Venkata Reddy et al. 2013, Int J Pharm Bio Sci 2013 Apr; 4(2): (B) 884 - 893A multiplex pcr based method for the detection of agriculturally important aflatoxingenic and ochratoxingenic fungal species from cereals.
- Mahalakshmi Rudrabhatla, 2007 Application Note 00927 A Rapid LC/MS/MS Method for the Analysis of Aflatoxins in Complex Matrices With Immunoaffinity Clean-up.
- Maragos, C.M., 2009, Mycotoxin Research, Photoreaction of indole-containing mycotoxins to fluorescent products. 25(2):67-75.
- McDaniel et al. 2011, Natural Resources, 2011, 2, 250-257 Effect of Matrix Clean-Up for Aflatoxin Analysis in Corn and Dried Distillers Grains.
- Mohammad Reza Siah Shadbad, et al. Adv Pharm Bull. 2012; 2(1): 123-126. Determination of aflatoxins in nuts of Tabriz confectionaries by ELISA and HPLC methods.
- Muscarella, M. et al., Food Additives and Contaminants, Vol. 26, No. 10, October 2009, 1402-1410, Validation of a confirmatory analytical method for the determination of aflatoxins B1, B2, G1 and G2 in foods and feed materials by HPLC with on-line photochemical derivatization and fluorescence detection.
- Ofitserova, M. et al., J AOAC Int. 2009, Jan-Feb; 92 (1), 15-25, Multiresidue mycotoxin analysis in corn grain by column high-performance liquid chromatography with postcolumn photochemical and chemical derivatization: Single laboratory validation.
- Papadopoulou-Bouraoui A., Stroka J., Anklam E., J., AOAC Int. Vol. 85, No. 2, 2002, 411-416, Comparison of two post-column derivatization systems, ultraviolet irradiation and electrochemical determination, for the liquid chromatographic determination of aflatoxins in food.
- Reiter, E.V. et al., 2009, Aflatoxins in palm kernel cake from Indonesia – Applicability of ELISA in contrast to HPLC 53-53.- 31st Mycotoxin Workshop; June 15-17, 2009; Münster, Germany.
- Reiter E.V. et al., A limited survey of aflatoxins in rice products marketed in Vienna, 31st Mycotoxin Workshop; June 15-17, 2009; Münster, Germany.
- Trucksess, M.W. et al., J AOAC Int. 2007 Jul-Aug; 90 (4) 1042-9, Use of mycotoxin columns for determination of aflatoxins and ochratoxin A in ginseng and ginger.
- Verordnung (EG) Nr. 1881/2006 Der Kommission vom 19. Dezember 2006 zur Festsetzung der Höchstgehalte für bestimmte Kontaminanten in Lebensmitteln.
- Verordnung (EG) Nr. 105/2010 DER KOMMISSION vom 5. Februar 2010 zur Änderung der Verordnung (EG) Nr. 1881/2006 zur Festsetzung der Höchstgehalte für bestimmte Kontaminanten in Lebensmitteln hinsichtlich Ochratoxin A.
- Vukovic, G. L. et al., Arch. Biol. Sci, Belgrade, 61 (4), 639 - 644, 2009, Comparison of two sample preparation procedures for HPLC determination of Ochratoxin A.
- Yunus et al. 2011, The Journal of Animal & Plant Sciences, 21(2): 2011, p 303-304 a simple method for producing aflatoxin B1 on rice medium for use in experimental animal feeds.



## LCTech GmbH

Daimlerstr. 4 • 84419 Obertaufkirchen • Germany

Tel: +49 8082 2717-0 • Fax: +49 8082 2717-100

info@LCTech.de • www.LCTech.de

Please send requests regarding mycotoxins to: [mycotoxins@LCTech.de](mailto:mycotoxins@LCTech.de)

The information contained in this brochure is based on our current knowledge and has been carefully checked. However, since we continually work on the further development of our products, please accept texts, pictures and numbers on these pages as non-binding and exemplary only.