

# Biotage® Extrahera™

Installation and Safety



# Biotage® Extrahera™

## Installation and Safety

### CONTENTS

#### 1 Installation

- 1 Download Biotage® Extrahera™ User Documentation
- 1 Software License Agreement
- 1 Delivered Items
- 1 Site Requirements
- 2 Move the System
- 5 Connections
- 5 Upgrade the Biotage® Extrahera™ Software

#### 6 Technical Specifications

- 6 System Requirements
- 6 Liquid Handling
- 6 Interfaces
- 7 Clog Detection

#### 8 Safety

- 8 Intended Use
- 8 Education, Training, and Competence
- 8 Warranty and Liability
- 8 Service
- 8 Safety Features
- 8 Labels
- 9 Explosion Risk
- 9 Safety Requirements
- 11 Restriction of Hazardous Substances (RoHS) Directive
- 11 WEEE Compliance Statement
- 11 Safety in Other Languages

#### 12 General Information

- 12 Consumables and Accessories
- 12 Manufacturer
- 12 Contact Us

# Installation

## Warning

- » The system must be unpacked and installed by an authorized Biotage service engineer.
- » Follow regional safety practices when handling and moving shipping boxes and containers, and moving the system.
- » Observe general and specific safety regulations for the use of the system and its accessories and consumables at all times, in order to reduce the risk of personal injury, fire, and explosion; see "Safety Requirements" on page 9.

## Download Biotage® Extrahera™ User Documentation

The following user documentation is supplied with the system and can be downloaded at [www.biotage.com](http://www.biotage.com):

- » Biotage® Extrahera™ Installation and Safety, P/N 414157 (this document)
- » Biotage® Extrahera™ User Manual, P/N 414158
- » Biotage® Extrahera™ Safety Translations, P/N 414159

If you have problems downloading the user documentation, please contact your local Biotage representative. See contact information on the back of this document or visit our website [www.biotage.com](http://www.biotage.com).

## Software License Agreement

Biotage Sweden AB licenses the Biotage® Extrahera software to you only upon the acceptance of all of the terms and conditions in the software license agreement.

By using the software, you consent to be bound by and are becoming a party to that agreement.

To read the software license agreement, either request a copy from your local Biotage representative before the installation or read it on your Biotage® Extrahera system by pressing **Licenses** in the software's **About** view.

## Delivered Items

**Note:** We recommend that the boxes and packing materials are kept by the customer in case the system needs to be returned for service or moved to another location.

Check the delivery against the shipping documentation to ensure that all parts are included in the shipment. If any part of the order is missing or damaged, please contact Biotage® 1-Point Support™.

## Site Requirements

Before the system is installed by an authorized Biotage service engineer, the installation site should be prepared as follows:

### Fume hood/ventilation system

The system must be either connected to a ventilation system or placed in a well-ventilated fume hood or an equivalent enclosure to reduce the risk of exposure to harmful gases. The ventilation system or fume hood must be capable of exhausting 6 cubic meters/min (212 cubic feet/min).

If the system is to be installed on a benchtop (outside a fume hood or equivalent enclosure), an air duct adapter supplied with the system must be installed on the top of the ventilation fan to allow connection to suitably sized ventilation tubing.

The outer diameter of the air duct adapter is  $159.0 \pm 0.3$  mm ( $6.26" \pm 0.01"$ ) and the inner is  $152.7 \pm 0.3$  mm ( $6.01" \pm 0.01"$ ), i.e. the 160 mm tube should be mounted outside the air duct adapter and the 6" tube on the inside of the air duct adapter.

### Weight and dimensions

The total weight of the package including the system is 120 kg (265 lbs). Use suitable lifting equipment when moving the package. The system is supplied on pallet and the dimensions of the package (+ pallet) are: 1230 x 840 x 800 mm ( $48.4" \times 33.1" \times 31.5"$ ).

The fume hood or bench must be able to support the weight of the system, i.e. 75 kg (165 lbs).

The dimensions of the system are (W x D x H):  
Without touch screen: 610 x 510 x 730 mm ( $24.0" \times 22.1" \times 28.7"$ )  
With touch screen: 860 x 570 x 730 mm ( $33.8" \times 22.4" \times 28.7"$ )

### Operating temperature

18°C to 32°C

### Ambient air

The system must be located in an area where the ambient air is clean. No emission of solid particles or smoke in the air by adjacent equipment is allowed. The level of dust should be comparable to that of normal laboratory spaces.

Humidity: 10% to 90% RH

### Electrical supply

100 to 240 VAC, 50/60 Hz, 300 VA

Connect only to a properly grounded outlet.

### Vacuum supply

Partial pressure range: < 500 mbar (50 kPa; 7 psi)

Flow rate:  $\geq 8.3$  L/min (0.29 cubic feet/min)

Connection: The vacuum tube supplied with the system has a 6 mm (0.24") outer diameter and 4 mm (0.16") inner diameter.

**Positive pressure unit**

The gas applied to the samples (i.e. the gas connected to the **N<sub>2</sub>** port) must be according to ISO 8573-1, classification 1-6-1. This is essential to prevent sample contamination and general fouling of the pressure unit. The filter unit that is supplied with the system delivers according to ISO 8573-1, class 1-x-1. If the gas applied is not according to class x-6-x, an air dryer needs to be ordered separately (P/N 416441SP).

**AIR** port requirements: 5 L/min (0.18 cubic feet/min), 6 ± 0.2 bar (0.6 ± 0.02 MPa; 87 ± 3 psi) for a fully populated extraction plate/rack and lower to approximately 4 bar (0.4 MPa; 58 psi) when 50% of the plate/rack is populated and 3 bar (0.3 MPa; 44 psi) when 25% of the plate/rack is populated.

**N<sub>2</sub>** port requirements: 1 L/min (0.04 cubic feet/min) during processing and 70 L/min (2.5 cubic feet/min) during plate dry, 6 ± 0.2 bar (0.6 ± 0.02 MPa, 87 ± 3 psi)

Connection: The gas tube supplied with the system has a 6 mm (0.24") outer diameter and 4 mm (0.16") inner diameter.

**External fire protection**

External fire protection should be installed according to local regulations for equipment operating unattended.

## Move the System

**Warning**

- » Before moving the system, please read and observe the safety requirements in "Safety Requirements" on page 9.

If you need to move the system within the laboratory or between laboratories in the same building, follow the instructions below. If you need to ship the system, please contact Biotage® 1-Point Support™ for instructions.

1. Prepare the new site according to the site requirements on page 1.
2. Clean the waste tubing as described in the user manual (P/N 414158).
3. Empty the system of liquids by flushing it with air:
  - a. Remove the solvent inlet lines from their bottles and place them in an empty, clean bottle.
  - b. Ensure that you have five empty solvent reservoirs in the solvent rack in position **5** on the working area.
  - c. Press **Maintenance** in the main menu.
  - d. Press **Flush Solvent Inlets....**
  - e. Enter the flush volume for S1. 25 mL is required to empty the solvent inlet line and pump of liquid.
  - f. Press **Flush** for S1.
  - g. When you have finished flushing the solvent inlet line with air, repeat steps e to f for the other solvent inlet lines (S2-S5).

4. Remove the solvent racks in position **5** and **6** (if used) on the working area and empty the reservoirs.
5. Remove all accessories and consumables inside the system, i.e. the pipette tip waste bin, plates, racks, etc.
6. Turn off the vacuum pump or, if your system is connected to another vacuum source, close the valve.
7. Shut down the system by pressing **Shut Down** in the main menu or login view (GLP) and then **Yes** to confirm.
8. When the message saying that it is safe to turn off the system appears on the screen, turn off the system. The mains switch is located on the right hand side at the rear of the system.
9. Unplug the power cord from the power outlet.
10. Turn off the gas supply/supplies, and disconnect the pressure regulators and the gas tubes from 1) the supply/supplies and 2) the **AIR** and **N<sub>2</sub>** ports located on the right hand side at the rear of the system.
11. Disconnect the waste outlet tube from the waste reservoir and empty the waste reservoir.
12. Clean the interior of the system and the accessories as described in the user manual (P/N 414158).
13. Clean the touch screen and the exterior of the system, using a soft and clean cloth. The cloth can be dry or lightly dampened with a neutral detergent or alcohol.
14. If you need to remove the touch screen (computer):
  - a. Adjust the ball mount angle so that the rear of the touch screen can be accessed; see Figure 1.
  - b. Remove the lower panel by unscrewing the six screws using a Philips #2 screwdriver.
  - c. Disconnect the power connector by unscrewing its locking ring.
  - d. Disconnect the two Ethernet cables and any USB devices.
  - e. Remove the touch screen by loosening the ball mount.

**Note:** The touch screen must be placed on a flat and level surface to avoid damage.



Figure 1. The rear of the touch screen (computer).

15. Attach the four lifting handles to the system; see Figure 2. The handles are supplied with the system.



**Figure 2.** The four lifting handles supplied with the system must be used when moving the system.

16. The system weighs 75 kg (165 lbs). Carefully lift the system using the four lifting handles and place it on a trolley that can support the weight of the system. Four persons are required when lifting the system.
17. Move the trolley and the rest of the equipment (the pipette tip waste bin, waste reservoir, vacuum pump (if used), solvent bottles, etc.) to the new location.
18. Carefully lift the system and place it in a well-ventilated fume hood or on a bench. Four persons are required when lifting the system. Place the system so that the mains switch is easy to access.
19. If the system is not placed in a fume hood, connect the outlet of the Extrahera top ventilation to a ventilation system:
- Connect an air duct adapter from Biotage to the outlet of the Extrahera top ventilation.
  - Connect a ventilation tube between the air duct adapter and the exhaust. The outer diameter of the air duct adapter is  $159.0 \pm 0.3$  mm ( $6.26'' \pm 0.01''$ ) and the inner is  $152.7 \pm 0.3$  mm ( $6.01'' \pm 0.01''$ ), i.e. the 160 mm tube should be mounted outside the air duct adapter and the 6" tube on the inside of the air duct adapter. Ensure that the tube cannot be blocked.
20. It is important that the system is not tilting backward. Level the system by adjusting the height of the feet. There is a built-in spirit level in the bottom of the system, in the front left corner. See Figure 3.



**Figure 3.** The built-in spirit level in the bottom of the system, in the front left corner.

21. Place the solvent bottles on the side of the system and insert the solvent inlet lines into the correct bottles. Ensure to use appropriate caps to prevent harmful solvent vapors from escaping and the contents from being spilled.
22. Place the waste reservoir on the side of the system and connect the waste outlet tube and vacuum to it; see Figure 4. If using a vacuum pump, ensure that the vacuum pump fumes are directed into a proper ventilation system.

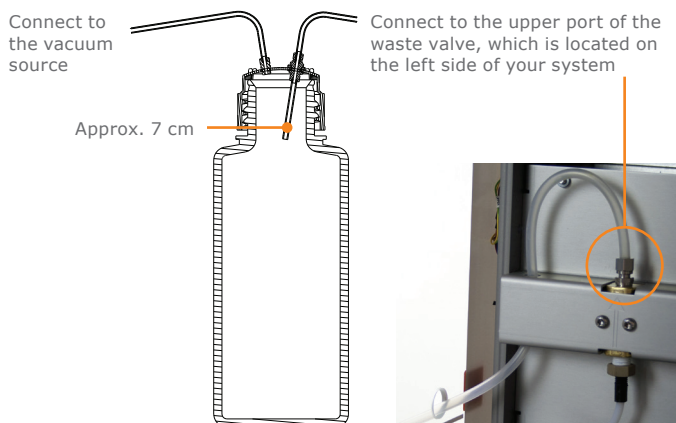

**Figure 4.** The setup of the waste kit.

23. Before connecting air and/or nitrogen to the system, the pressure head must be removed to protect it from contamination:
- Remove the two screws holding the pressure head to the pressure unit; see Figure 5.



**Figure 5.** The two screws attaching the pressure head to the pressure unit.

- Remove the pressure head by pulling it down and then pulling it out.

**Note:** If you have a system with only one gas tube connected to the pressure head, you have to tilt the pressure head horizontally to be able to pull it out.

- Disconnect the gas tubes (or tube) from the pressure head by pushing in the collar of each connector against the fitting and pulling the tubing out; see Figure 6.
- Put the pressure head on a clean and lint-free surface.



**Figure 6.** System with two gas tubes connected to the pressure head.



- Connect a pressurized air or nitrogen supply to the **AIR** port located on the right hand side at the rear of the system using the pressure regulator as shown in Figure 7.

The gas connected to the **AIR** port is used to seal the plate/columns. The pressure should be adjusted according to how many positions in the extraction plate or column rack that are populated. Use  $6 \pm 0.2$  bar ( $0.6 \pm 0.02$  MPa;  $87 \pm 3$  psi) for a fully populated plate/rack and lower to approximately 4 bar (0.4 MPa; 58 psi) when 50% of the plate/rack is populated and 3 bar (0.3 MPa; 44 psi) when 25% of the plate/rack is populated.



**Figure 7.** The setup of the pressure regulator for the AIR port.

- Connect a pressurized air or nitrogen supply to the **N<sub>2</sub>** port located on the right hand side at the rear of the system using the filter unit with a pressure regulator; see Figure 8. Set the pressure to  $6 \pm 0.2$  bar ( $0.6 \pm 0.02$  MPa;  $87 \pm 3$  psi).

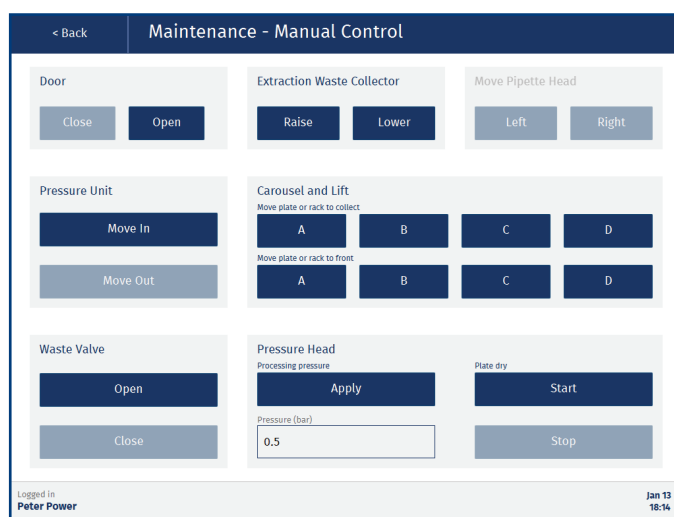

**Figure 8.** The setup of the filter unit for the N<sub>2</sub> port.

- If you have the Extrahera GLP software and you want to connect the system to your network, connect a network cable between the **LAN** port located on the right hand side of the system and your network.
- If you have disconnected the touch screen, reconnect it by reversing the instructions in step 14.
 

**Note:** Do not mix up the Ethernet cables. Connect according to the labeling on the cables and the ports (**LAN 1** and **LAN 2**).
- Connect the system to a properly grounded (earthed) power outlet with the correct mains voltage and frequency.

- Ensure that the power cord and any cables, hoses, and tubing connected to the system cannot come in contact with chemicals. Corrosives and solvents can degrade the cord/cable insulation and dissolve the hoses and tubing. There is a risk of electric shock, fire, and/or equipment damage.
- Turn on the system. The mains switch is located on the right hand side at the rear of the system.
- Purge the system:
  - Press **Maintenance** in the software's main menu.
  - Press **Manual Control...** and then **Close** in the **Door** field.
  - Press **Move Out** in the **Pressure Unit** field.
  - Enter 0.5 bar in the **Pressure (bar)** text box; see Figure 9.
  - Press **Apply**, wait for 15 seconds and then press **Stop**.
  - Press **Move In** in the **Pressure Unit** field.
  - Press **Open Door**.



**Figure 9.** The Manual Control view.

- Reconnect the gas tubes to the pressure head. Ensure that they are properly fastened by pulling on them and that they are on the left side of the bracket as shown in Figure 10.

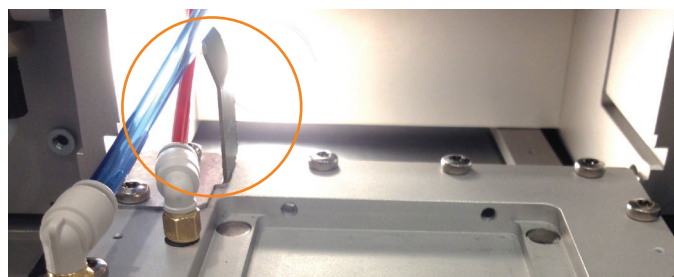

**Figure 10.** Ensure that the gas tubes are on the left side of the highlighted bracket.

- Put the pressure head back in place using the two screws. Do not overtighten the screws.

34. Place the pipette tip waste bin for used pipette tips below the **WASTE** position on the working area.
35. Place the solvent rack with five new, empty solvent reservoirs in position **5** on the working area. Ensure that the solvent feeder is pulled out into the correct position; see Figure 11.

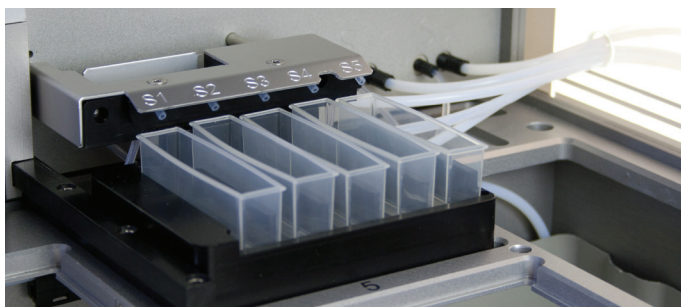

Figure 11. The solvent feeder in position.

## Connections

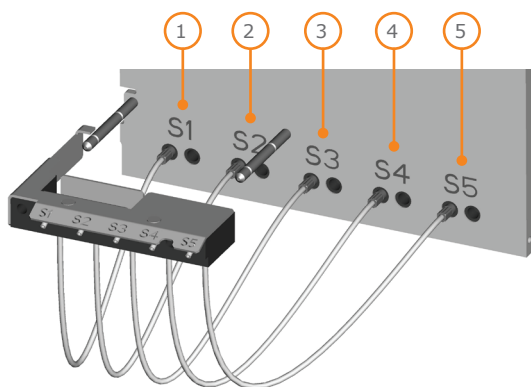

Figure 12. Solvent connections located on the back wall inside the system.

Port	Label	Connect
1	S1	The S1 solvent inlet line (right port) and the S1 solvent feeder tube (left port).
2	S2	The S2 solvent inlet line (right port) and the S2 solvent feeder tube (left port).
3	S3	The S3 solvent inlet line (right port) and the S3 solvent feeder tube (left port).
4	S4	The S4 solvent inlet line (right port) and the S4 solvent feeder tube (left port).
5	S5	The S5 solvent inlet line (right port) and the S5 solvent feeder tube (left port).

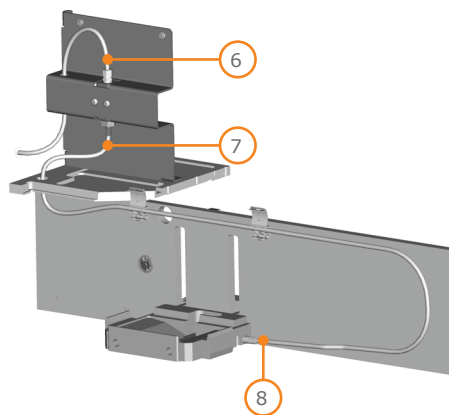

Figure 13. Waste connections located on the back wall inside the system.

Port	Label	Connect
6		Waste outlet tube between the waste valve and the waste reservoir.
7 + 8		Waste tube between the waste valve and the extraction waste collector.

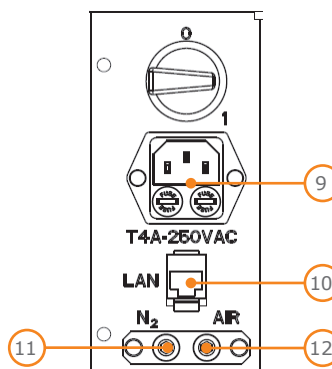

Figure 14. Connections located on the right hand side at the rear of the system.

Port	Label	Connect
9	T4A-250VAC	Electrical supply: 100 to 240 V~, 50/60 Hz, 300 VA  Fuses: T4A (2 required)
10	LAN	Network. Optional.
11	N <sub>2</sub>	The gas applied to the samples through the pressure head. See the gas supply requirements in the technical specification on page 6.
12	AIR	The gas used for the movement of the pressure head. See the gas supply requirements in the technical specification on page 6.

## Upgrade the Biotage® Extrahera™ Software

Please refer to the instructions delivered with the new software.

# Technical Specifications

**Note:** The system contains corrosion sensitive parts. Best practice is to avoid sustained continuous exposure to acidic and basic vapors by always removing the solvent reservoirs when the system is not in use, and cleaning the system following usage. Usage of strong acids (e.g. TFA and TCA) and inorganic acids (e.g. nitric, sulfuric, hydrochloric acid, and perchloric acids) in the solvent pumps is not supported at any concentration.

## System Requirements

<b>Ambient temperature</b>	Operating temperature: 18°C to 32°C Storage and transportation temperature: -25°C to 60°C
<b>Humidity</b>	10% to 90% RH
<b>Electrical supply</b>	100 to 240 VAC, 50/60 Hz
<b>Fuses</b>	T4A at the power inlet (2 required)
<b>Maximum power consumed</b>	300 VA
<b>Gas supply</b>	The gas applied to the samples (i.e. the gas connected to the <b>N<sub>2</sub></b> port) must be according to ISO 8573-1, classification 1-6-1. The filter unit that is supplied with the system delivers according to ISO 8573-1, class 1-x-1. If the gas applied is not according to class x-6-x, an air dryer needs to be ordered separately (P/N 416441SP).  <b>AIR</b> port: 5 L/min (0.18 cubic feet/min), 6 ± 0.2 bar (0.6 ± 0.02 MPa; 87 ± 3 psi) for a fully populated extraction plate/rack and lower to approximately 4 bar (0.4 MPa; 58 psi) when 50% of the plate/rack is populated and 3 bar (0.3 MPa; 44 psi) when 25% of the plate/rack is populated.  <b>N<sub>2</sub></b> port: 1 L/min (0.04 cubic feet/min) during processing and 70 L/min (2.5 cubic feet/min) during plate dry, 6 ± 0.2 bar (0.6 ± 0.02 MPa, 87 ± 3 psi)
<b>Vacuum supply</b>	Partial pressure range: < 500 mbar (50 kPa; 7 psi)  Flow rate: ≥ 8.3 L/min (0.29 cubic feet/min)
<b>Weight</b>	75 kg (165 lbs)
<b>Dimensions (WxDxH)</b>	Without touch screen: 610 x 510 x 730 mm (24.0" x 22.1" x 28.7")  With touch screen: 860 x 570 x 730 mm (33.8" x 22.4" x 28.7")
<b>Max sound level</b>	65 dB(A)

## Liquid Handling

<b>Solvent inlets</b>	5  Solvents are pumped into five 25 mL reservoirs inside the system using the five solvent pumps.  It is possible to have an extra solvent rack with five 25 mL or 100 mL reservoirs. These have to be filled manually.  The dead volume is 4 mL for both the 25 and 100 mL reservoir, and the 100 mL reservoir has a maximum fill volume of 90 mL.
<b>Waste outlet</b>	1
<b>Pipetting pump</b>	50 to 1000 µL  At 50 µL: ±2.0% accuracy and 1.0% CV At 100 µL: ±2.0% accuracy and 1.0% CV At 500 µL: ±1.5% accuracy and 1.0% CV At 1000 µ: ±1.0% accuracy and 1.0% CV
<b>Processing format</b>	96-well extraction plates, 96-array plates for 1 and 2 mL wells, 96-position extraction racks for 1 mL (tablets) columns (A format), 48-well extraction plates, 48-position extraction racks for 3 mL (tablets) columns (B format), and 24-position extraction racks for 1, 3, and 6 mL (tablets) columns (A, B, and C format)
<b>Processing pressure</b>	0 to 5 bar
<b>Interfaces</b>	
<b>Touch screen</b>	12.1"
<b>Ethernet LAN</b>	Complies with IEEE 802.3 (ANSI 8802-3)
<b>USB</b>	USB 2.0



## Clog Detection

With an Extrahera GLP software license installed on your system (sold separately), clog detection is available for load, wash, and elute operations in the SPE, SLE, and Filtration+ methods.

### Supported Solvents

Solvent/Solvent Combination	Clog Detection Compatibility
Acetone	Good
Acetonitrile	Excellent
Chloroform	Poor
Dichloromethane	Poor
Diethyl ether	Poor
Dimethylformamide (DMF)	Excellent
Dimethylsulfoxide (DMSO)	Excellent
Ethanol	Excellent
Ethyl acetate	Good
Heptane	Good
Hexane	Poor
Isooctane	Good
Isopropanol	Excellent
Methanol	Excellent
Pentane	Poor
Tetrahydrofuran (THF)	Poor
Toluene	Excellent
Water	Excellent
Methyl tert-butyl ether (MTBE)	Poor
IPA 30%	Excellent
Ammonium hydroxide 5%	Excellent
Formic acid 4.6M	Excellent
DCM/IPA, [90:10]	Poor
DCM/IPA, [95:5]	Poor
DCM/IPA/NH <sub>4</sub> OH [78:20:2]	Poor
DCM/MeOH/NH <sub>4</sub> OH [78:20:2]	Poor
MeOH/NH <sub>4</sub> OH [95:5]	Excellent

### Currently Not Supported Consumables

The following Biotage and competitor consumables are not supported when using clog detection:

- » ISOLUTE® PPT+
- » ISOLUTE® PLD+
- » ISOLUTE® FILTER+ Plate
- » Waters Oasis  $\mu$ Elution Plates
- » Tecan NBE and Cerex Columns
- » 1 mL Columns, 24 Positions Configuration
- » 1 mL Columns, 96 Positions Configuration

# Safety

## Intended Use

The Biotage® Extrahera™ system from Biotage is intended solely for automating sample preparation. The system has to be operated in a laboratory environment by trained professionals. All operations must be performed:

- » According to the user documentation delivered with the system.
- » According to instructions available at [www.biotage.com](http://www.biotage.com).
- » According to instructions provided through dialogs appearing on the screen.
- » According to instructions given by the technical support staff from Biotage.
- » Within limits set by the system's technical specification.

Failure to follow those instructions and operate within the limits set by the technical specification may result in personal injury and/or equipment damage.

## Education, Training, and Competence

It is your responsibility to provide all applicable health and safety regulations to your personnel. You must also ensure that all personnel involved in the operation and maintenance of the system fulfill the following criteria:

- » Have the necessary education, training, and competence required for the intended use of the system.
- » Observe general and specific safety regulations for the use of the system and its accessories and consumables at all times, in order to reduce the risk of personal injury, fire, and explosion.

## Warranty and Liability

See the "Biotage Terms & Conditions of Sale" document at [www.biotage.com](http://www.biotage.com).

## Service

All service must be performed by an authorized Biotage service engineer. Before handing over the system for service, it should be emptied of liquid and cleaned from harmful residues.

It is the responsibility of the customer to inform Biotage 1-Point Support representatives if the system has been used with hazardous biological, radioactive, or toxic samples and/or solvents, prior to any service being performed. When returning equipment to Biotage, this should be done in accordance with the material return procedures supplied separately by Biotage.

Only genuine Biotage accessories must be used in the system.

## Safety Features

The ventilated system enclosure protects the user against mechanical hazards and potentially harmful solvents and/or vapors. The system cannot be operated when:

- » the door is open, and/or
- » the integral system ventilation fan is not working.

## Labels

Labels used on the system:



In accordance with all the essential requirements of all applicable European product directives; see the Declaration of Conformity document supplied with the product.



In accordance with both U.S. and Canadian safety standards; see the Declaration of Conformity document supplied with the product.

### RoHS

In accordance with the Restriction of Hazardous Substances Directive; see "Restriction of Hazardous Substances (RoHS) Directive" on page 11 and the Declaration of Conformity document.



The product contains certain hazardous substances and can be used safely during its environmental protection use period (EPUP), as indicated by the number in the center, and should enter into the recycling system after the EPUP.



Subject to the Waste Electrical and Electronic Equipment (WEEE) Directive; see "Restriction of Hazardous Substances (RoHS) Directive" on page 11.



Manufacturer.



Consult accompanying user documentation.



The samples used with the system are potentially hazardous and can cause illness.

Observe general as well as specific safety regulations for the use of the system and its accessories and consumables at all times, in order to reduce the risk of personal injury; see "Safety Requirements" on page 9.



There is a risk of crushing when the system is in service mode. Note that all service must be performed by an authorized Biotage service engineer.

## Explosion Risk

The system has open solvent reservoirs. If the ventilation fails and solvent vapors are not removed, an explosive environment could be generated. If the system is found with the door closed and the power off, you must:

1. Ventilate the system properly by opening the door manually using the T25 Torx screwdriver supplied with the system; see Figure 15 below. Ensure to take the necessary precautions to avoid exposure to potentially harmful solvents and/or vapors.
2. Remove all solvent reservoirs and remove any spillage before turning the system back on.

We do not recommend that the system is left unattended for an extended period of time when using flammable solvents.



**Figure 15.** Open the door manually by turning the screw counterclockwise.

## Safety Requirements

You must observe all safety requirements when installing and operating the system. Failure to install or use the system in a manner specified by Biotage may result in personal injury and/or equipment damage. If the system has been damaged or does not function properly, shut it down, remove any solvents, samples, and waste inside the system, and contact Biotage 1-Point Support immediately ([www.biotage.com](http://www.biotage.com)).

## Installation

- » The system must be unpacked and installed by an authorized Biotage service engineer. Prepare the installation site as described on page 1.
- » Follow regional safety practices when handling and moving shipping boxes and containers, and moving the system.
- » The total weight of the package including the system is 120 kg (265 lbs). Use suitable lifting equipment when moving the package.
- » The system weighs 75 kg (165 lbs). The four lifting handles supplied with the system must be used when moving the system. Four persons are required when lifting the system.
- » Do not place any equipment or bottles on top of the system.
- » The system must be electrically grounded (earthed). Use only a power cord supplied by Biotage. The ground prong on the cord plug must not be removed and the plug should only be connected to a grounded outlet as per local and national regulations. Keep the mains plug easily accessible in case the system needs to be disconnected quickly from mains power.
- » Ensure that the power cord and any cables, hoses, and tubing connected to the system cannot come in contact with chemicals. Corrosives and solvents can degrade the cord/cable insulation and dissolve the hoses and tubing. There is a risk of electric shock, fire, and/or equipment damage.
- » The system must be either connected to a ventilation system or placed in a well-ventilated fume hood or an equivalent enclosure to reduce the risk of exposure to harmful gases. The ventilation system or fume hood must be capable of exhausting 6 cubic meters/min (212 cubic feet/min).
- » When installing the system inside a fume hood, follow local and national safety regulations for installing a system inside a fume hood and the safety regulations supplied by the fume hood manufacturer.
- » When the system is connected to a ventilation system, an air duct adapter from Biotage must be mounted between the outlet of the Extrahera top ventilation and the ventilation tube. Ensure that the ventilation tube cannot be blocked.
- » If using a vacuum pump, ensure that the fumes are directed into a proper ventilation system.

## Operation

- » Use the system only for its intended purpose, as described in the user documentation delivered with the system and user documentation available at [www.biotage.com](http://www.biotage.com).
- » To avoid leakage, check the following before operating the system:
  - » Ensure that all connections are properly connected and tightened (see the "Connections" section on page 5).
  - » Ensure that the extraction waste collector, waste reservoir, and solvent rack with five reservoirs (in position **5** on the working area) are in place, and that the waste reservoir and the pipette tip waste bin are not full.
  - » Ensure that pipette tips of the correct size have been loaded into the correct positions in the pipette tip racks.
- » To avoid damaging the system, use care to ensure that all solvents used with the system are free of particulates.
- » Never operate the system when damaged.

## Chemical and Biological Safety

- » Check regularly for leaks and spills. If leakage is observed, follow the instructions in the "Troubleshooting" section in the "Biotage® Extrahera™ User Manual" document. If spillage has occurred, follow the instructions for cleaning the interior of the system in the "Biotage® Extrahera™ User Manual" document.
- » Always place the solvent bottles and waste reservoir on the side of the system.
- » Use appropriate caps on the solvent bottles to prevent harmful solvent vapors from escaping and the contents from being spilled.
- » The system operates using electricity, which can introduce additional hazards with certain solvents if not properly connected, vented, or set up with recommended manufacturer approved settings.
- » Never leave solvents, samples, or waste inside the system when the ventilation is turned off.
- » Follow all generally-accepted lab safety procedures and applicable laws and regulations.
- » All samples and waste should be treated as potentially biohazardous.
- » Always follow local and national safety regulations related to storage, handling and disposal of chemicals, biological samples and waste.
- » Read and understand the safety data sheet (SDS) provided by the chemical manufacturer before storing, handling, working with, or disposing of any chemical or hazardous substance.
- » Personnel working with or near the system must wear protective clothing, safety gear, and eye protection that comply with local and national safety regulations.

## Maintenance and Troubleshooting

- » If the system is found with the door closed and the power off, ensure to ventilate the system properly before turning the system back on. Follow the instructions in the "Explosion Risk" section on page 9.
- » If the fan stops working, shut down the system, remove any solvents, samples, and waste inside the system, and contact Biotage 1-Point Support.
- » If the ventilation is too low, potentially harmful gases will escape into the surrounding environment. Ensure to take the necessary precautions to avoid exposure to harmful gases.
- » Follow all maintenance instructions in the "Maintenance" chapter of the "Biotage® Extrahera™ User Manual" document.
- » Clean the waste tubing regularly to avoid leakage caused by the tubing getting clogged. See instructions in the "Biotage® Extrahera™ User Manual" document.
- » There are no user serviceable parts inside the system. Covers and safety shields may only be removed by an authorized Biotage service engineer. Potential electrical hazard exists due to high voltage circuits inside the system.
- » The power cord should be inspected periodically and replaced if damaged or altered. Use only a power cord supplied by Biotage.
- » The system uses double pole fusing. Use only exact replacement fuses supplied by Biotage. Incorrect fuses create a potential fire hazard.
- » Use only tubing, nuts, and ferrules supplied by Biotage.
- » Use caution when finger-tightening fittings to prevent stripped threads or crushed ferrules.

## Restriction of Hazardous Substances (RoHS) Directive

The RoHS directive is a European Union-derived initiative in which the elimination of certain hazardous substances is the key objective. The elimination of these substances will contribute to the protection of human health and the environmentally sound recovery and disposal of equipment.

## WEEE Compliance Statement

### Valid for customers in EU countries



We are committed to being a good corporate citizen. As part of that commitment, we strive to maintain an environmentally conscious manufacturing operation. The European Union (EU) has enacted a directive on product recycling (Waste Electrical and Electronic Equipment, WEEE).

Products falling under the scope of the WEEE Directive are identified with a crossed over “wheelie bin” symbol on the product label, as indicated to the left. To forward a product for recycling or proper disposal, return them to Biotage Sweden AB. Before forwarding a product for recycling or disposal, it should be emptied of all liquid and cleaned from harmful residues. When returning a product to Biotage, this should be done in accordance with the material return procedures supplied separately by Biotage.

## Safety in Other Languages

Translated versions of the safety chapter can be downloaded at [www.biotage.com](http://www.biotage.com). If you have problems downloading the safety translations (“Biotage® Extrahera™ Safety Translations”), please contact your local Biotage representative. See contact information on the back of this document or visit our website [www.biotage.com](http://www.biotage.com).



# General Information

## Consumables and Accessories

Only genuine Biotage accessories must be used in the system.  
To order consumables and accessories, see contact information on the back of this document or visit our website [www.biotage.com](http://www.biotage.com).

## Manufacturer



Biotage GB Limited United Kingdom for  
Biotage Sweden AB

## Contact Us

### **Biotage Sweden AB**

Box 8  
SE-751 03 Uppsala  
SWEDEN

Visiting address: Vimpelgatan 5

Phone: +46 18 56 59 00  
Fax: +46 18 59 19 22  
E-mail: [info@biotage.com](mailto:info@biotage.com)  
Website: [www.biotage.com](http://www.biotage.com)

Please contact your local Biotage representative. See contact information on the back of this document or visit our website [www.biotage.com](http://www.biotage.com).



# Your Complete Partner for Effective Chemistry

Biotage is a worldwide supplier of instruments and accessories designed to facilitate the work of laboratory and process chemists. With our deep knowledge of the industry, academic contacts and in-house R&D teams, we can deliver the best solutions to your challenges. We take great pride in our flexibility and ability to meet our customer's individual needs. With strong foundations in both analytical, organic and process chemistry, we can offer the widest range of solutions available on the market.

## EUROPE

Main Office: +46 18 565900  
Toll Free: +800 18 565710  
Fax: +46 18 591922  
Order Tel: +46 18 565710  
Order Fax: +46 18 565705  
order@biotage.com  
Support Tel: +46 18 56 59 11  
Support Fax: + 46 18 56 57 11  
eu-1-pointsupport@biotage.com

## NORTH & LATIN AMERICA

Main Office: +1 704 654 4900  
Toll Free: +1 800 446 4752  
Fax: +1 704 654 4917  
Order Tel: +1 704 654 4900  
Order Fax: +1 434 296 8217  
ordermailbox@biotage.com  
Support Tel: +1 800 446 4752  
Outside US: +1 704 654 4900  
us-1-pointsupport@biotage.com

## JAPAN

Tel: +81 3 5627 3123  
Fax: +81 3 5627 3121  
jp\_order@biotage.com  
jp-1-pointsupport@biotage.com

## CHINA

Tel: +86 21 68162810  
Fax: +86 21 68162829  
cn\_order@biotage.com  
cn-1-pointsupport@biotage.com

## KOREA

Tel: + 82 31 706 8500  
Fax: + 82 31 706 8510  
korea\_info@biotage.com  
kr-1-pointsupport@biotage.com

## INDIA

Tel: +91 22 4005 3712  
india@biotage.com

Distributors in other regions  
are listed on [www.biotage.com](http://www.biotage.com)

Part Number: 414157-J

© 2020 Biotage. All rights reserved. No material may be reproduced or published without the written permission of Biotage. Information in this document is subject to change without notice and does not represent any commitment from Biotage. E&OE. A list of all trademarks owned by Biotage AB is available at [www.biotage.com/legal](http://www.biotage.com/legal). Other product and company names mentioned herein may be trademarks or registered trademarks and/or service marks of their respective owners, and are used only for explanation and to the owners' benefit, without intent to infringe.

