

Now sold under the  
Thermo Scientific brand

**Thermo**  
SCIENTIFIC

# Determination of Tobramycin and Impurities Using HPAE-PAD

## INTRODUCTION

Tobramycin is a water-soluble aminoglycoside antibiotic used in a variety of pharmaceutical applications, including ophthalmic and intravenous administrations.<sup>1</sup> Tobramycin is purified from the fermentation of the actinomycete *Streptomyces tenebrarius*. Kanamycin B (also known as bekanamycin), nebramine, and neamine (also known as neomycin A) are three known impurities of tobramycin,<sup>2</sup> resulting from either incomplete purification of the drug or from degradation of tobramycin. Figure 1 shows the chemical structure of tobramycin and its major impurities. The amounts of these impurities must be determined and meet specified limit criteria before a manufactured lot of tobramycin may be used clinically. These aminoglycosides, like most carbohydrates, lack a good chromophore and therefore require high concentrations to be detected by UV absorbance. Many ingredients of manufacturing process intermediates and final pharmaceutical formulations are chromophoric and can interfere with the direct detection of tobramycin and its impurities by absorbance. Refractive index detection has similar limitations. Carbohydrates, glycols, alcohols, amines, and sulfur-containing compounds can be oxidized and therefore directly detected by amperometry. This detection method is specific for those analytes that can be oxidized at a selected potential, leaving all other compounds undetected. Pulsed amperometric detection (PAD) is a powerful detection technique with a broad linear range and very low detection limits for aminoglycoside antibiotics.<sup>3,4</sup>

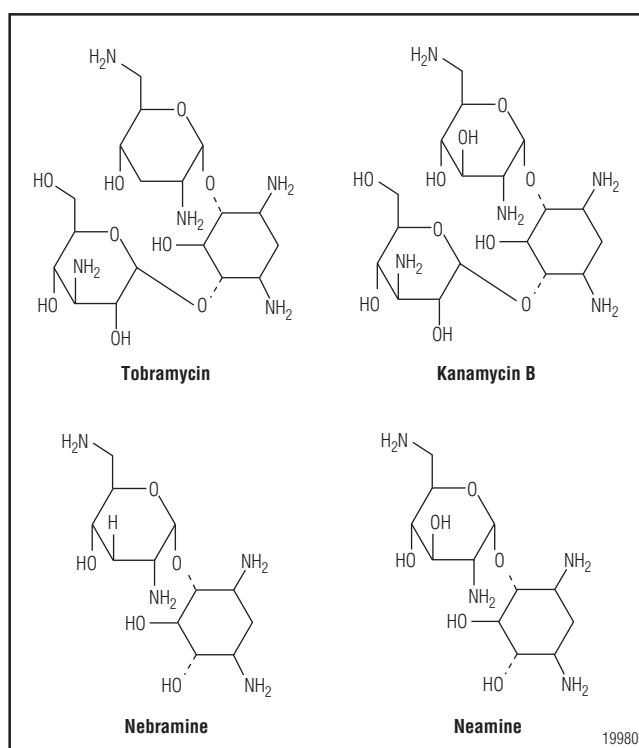

**Figure 1.** Chemical structures of tobramycin and known impurities (kanamycin, nebramine, and neamine).

High-performance anion-exchange chromatography (HPAE) is a technique capable of separating tobramycin and its impurities.<sup>5,6</sup> The CarboPac™ PA1 anion-exchange column retains tobramycin and its impurities, but requires a weak sodium hydroxide eluent (2 mM) that is difficult to prepare reproducibly without carbonate contamination. Varying amounts of carbonate contamination adversely affect retention time precision. This problem has limited the adoption of HPAE-PAD for tobramycin determinations.

In this application note, we show that an eluent generator solves the problem of consistent eluent preparation. An eluent generator can automatically prepare hydroxide eluents of precise concentrations that are essentially carbonate-free. The EG50 Eluent Generator automatically produces potassium hydroxide (KOH) eluent from water and a potassium electrolyte solution by means of electrolysis. The only carbonate in the mobile phase is that present in the water used to supply the eluent generator. The minor amounts of carbonate from the supply water, as well as borate and other contaminating anions, are removed by a Continuously Regenerated Anion Trap Column (CR-ATC) installed after the eluent generator. Consequently, the usual variability in hydroxide concentration associated with manual eluent preparation, and the variability of carbonate contamination due to adsorption of atmospheric carbon dioxide, are essentially eliminated, leading to highly reproducible retention times.

In addition to improving HPAE retention time reproducibility, we adopted disposable gold (Au) working electrodes to improve electrode-to-electrode (and system-to-system) reproducibility of tobramycin electrochemical response. Disposable Au working electrodes are manufactured in a manner that improves electrode-to-electrode reproducibility.<sup>7,8</sup> These electrodes are also easy to maintain (no polishing) and inexpensive to replace.

In this application note, we combine the CarboPac PA1, eluent generator with CR-ATC, and disposable Au working electrodes (Figure 2) to demonstrate an improved HPAE-PAD technology for tobramycin purity analysis. Key performance parameters are evaluated, including precision, limits of detection, linearity, and ruggedness, in a manner consistent with many requirements of normal method validation.<sup>9-16</sup> Overall, the described setup has improved sensitivity, good sample throughput (15 min per run), and improved retention time reproducibility. The automated production of KOH eluent improves reproducibility and eliminates eluent preparation errors.

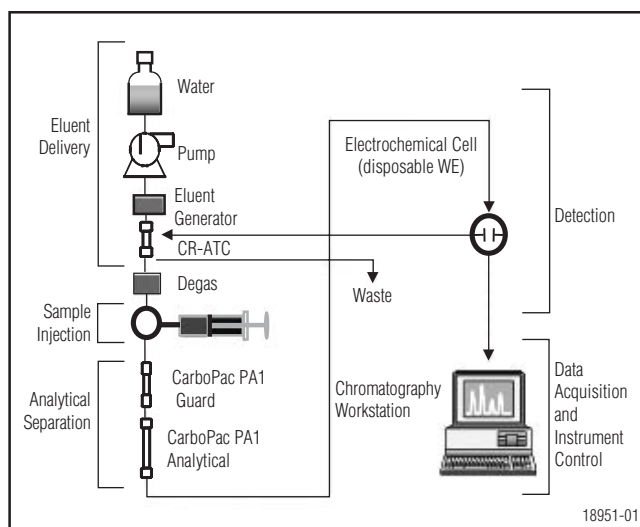

Figure 2. HPAE-PAD system for tobramycin determinations.

## EQUIPMENT

Dionex BioLC® system consisting of:

- GP50 Gradient or IP25 Isocratic Pump, with vacuum degas option and GM-4 Gradient Mixer
- ED50 Electrochemical Detector and Combination pH/Ag/AgCl Reference Electrode (P/N 044198) with either:
  - Carbohydrate Certified (Au) Disposable Electrodes (P/N 060139, package of 6; or 060216, package of 24)
  - AAA-Direct™ Certified (Au) Disposable Electrodes (P/N 060082, package of 6; 060140, package of 24)
- EG50 Eluent Generator with EGC II KOH eluent generator cartridge (EluGen II Hydroxide; P/N 053921)
- EG40/50 Vacuum Degas Conversion Kit (P/N 055431)
- CR-ATC, Continuously Regenerated Anion Trap Column (P/N 060477)
- AS50 Autosampler with 20-µL injection loop
- AS50 Thermal Compartment
- EO1 Eluent Organizer, including four 2-L plastic bottles and pressure regulator

Chromeleon® Chromatography Workstation  
 Helium; 4.5-grade, 99.995%, <5 ppm oxygen (Praxair)  
 Filter unit, 0.2 µm nylon (Nalgene 90-mm Media-Plus,  
 Nalge Nunc International, P/N 164-0020 or equivalent  
 nylon filter)  
 Vacuum pump (Gast Manufacturing Corp.,  
 P/N DOA-P104-AA or equivalent)  
 0.3 mL Polypropylene Injection Vials with Caps (Vial Kit,  
 Dionex P/N 055428)

## REAGENTS AND STANDARDS

### Reagents

Deionized water, 18 MΩ-cm resistance or higher

### Standards

Tobramycin (Sigma-Aldrich Chemical Co, Cat. #T40014)  
 Kanamycin B (also known as bekanamycin sulfate; Sigma-  
 Aldrich Chemical Co, Cat. #B5264)  
 Neamine hydrochloride (also known as Neomycin A  
 hydrochloride; International Chemical Reference  
 Substances; World Health Organization; Cat. #9930354)

## CONDITIONS

### Method

Columns: CarboPac PA1 Analytical,  
 4 × 250 mm (P/N 035391)  
 CarboPac PA1 Guard, 4 × 50 mm  
 (P/N 043096)  
 Flow Rate: 0.5 mL/min  
 Injection Volume: 20 µL (full loop)  
 Temperature: 30 °C  
 Detection (ED50): Pulsed amperometry, Carbohydrate  
 Certified disposable Au working  
 electrodes (P/N 0600139), or  
 AAA-Direct Certified disposable Au  
 working electrodes (P/N 060082)  
 Background: 28–35 nC (using the Carbohydrate  
 waveform)  
 33–96 nC (using the AAA-Direct  
 waveform)  
 Typical System Operating Backpressure:  
 2460–2590 psi (with restrictor tubing  
 installed between the degas apparatus  
 and the injector)  
 Eluent Generation Method:  
 2 mM KOH; isocratic, 15-min run time

## Carbohydrate Waveform for the ED50\*

Time (s)	Potential (V)	Integration
0.00	+0.1	
0.20	+0.1	Begin
0.40	+0.1	End
0.41	–2.0	
0.42	–2.0	
0.43	+0.6	
0.44	–0.1	
0.50	–0.1	

Reference electrode in Ag/AgCl mode

\* Waveform A in Technical Note 21.<sup>17</sup>

## AAA-Direct Waveform for the ED50 (Alternative, for increased sensitivity)\*\*

Time (s)	Potential (V)	Integration
0.00	+0.13	
0.04	+0.13	
0.05	+0.33	
0.21	+0.33	Begin
0.22	+0.55	
0.46	+0.55	
0.47	+0.33	
0.56	+0.33	End
0.57	–1.67	
0.58	–1.67	
0.59	+0.93	
0.60	+0.13	

Reference electrode in pH mode

\*\* Waveform used for this note. For the most current  
 waveform, see the product manuals for the  
 AAA-Direct Amino Acid Analysis System.<sup>18</sup>

## PREPARATION OF SOLUTIONS AND REAGENTS

### Eluents

It is essential to use high-quality water of high resistivity (18 MΩ-cm) that contains as little dissolved carbon dioxide as possible. Biological contamination should be absent. Source water must be obtained using a water purification system consisting of filters manufactured without electrochemically active substances (e.g., glycerol). Prior filtration through 0.2-µm porosity nylon under vacuum is recommended to remove particulates and reduce dissolved air. Keep the eluent water blanketed under 34–55 kPa (5–8 psi) of helium at all times to reduce diffusion of atmospheric carbon dioxide and opportunistic microorganisms.

## STOCK STANDARDS

Solid tobramycin, kanamycin B, and neamine standards were placed in plastic vials and dissolved in deionized water to a 10-mg/mL concentration. The masses of moisture, salt, and impurities, as stated on the manufacturer's Certificate of Analysis, were subtracted from the measured mass to improve accuracy of the solutions. These solutions were further diluted with water to yield the desired stock mixture concentrations. For this note, all dilutions were made gravimetrically to ensure high accuracy. The solutions were maintained frozen at  $-40\text{ }^{\circ}\text{C}$  until needed. Masses of 1, 2, 20, 100, 200, 300, 400, and 600 pmol tobramycin were injected for linearity studies.

*Note: Tobramycin—and to a lesser extent kanamycin B—when dissolved in water, adsorbs to glass surfaces. Significant losses due to adsorption occur at dilute concentrations. Polypropylene injection vials and other labware must be used to ensure accurate results.*

## RESULTS AND DISCUSSION

### Separation

Figure 3 shows the separation of tobramycin (peak 5) from five impurities (peaks 1, 2, 3, 4, and 6) using a CarboPac PA1 column set. Panel A shows the full display of the tobramycin peak, whereas panel B expands the baseline to view early-eluting impurity peaks. This isocratic method was optimized for throughput, for resolution of tobramycin (5.7 min) from impurities (3.0–3.1, 3.4–3.5, 4.1–4.2, and 4.6–4.7 min) and the void (2.7–2.8 min), and for noninterfering locations of baseline dips (6.0, 10.7, 15.5, and 31.0 min). Impurity peak 3 (Figure 3) was identified as kanamycin B, and peak 4 was identified as neamine (neomycin A) based on the retention time of standards. Impurity peak 1 was also observed to a lesser extent in the water blank injections, and it and other sporadically observed minor peaks were eliminated when injection vials were prerinsed three times with water before use.

Baseline dips associated with injections of water or samples are likely caused by trace organic impurities present in the sample or water separated on the CarboPac PA1 column by means of secondary interactions (e.g., hydrophobic interactions). When these compounds elute, they exclude electrochemically active ions in the eluent. The oxygen dip ( $\sim 31$ -min retention time) is due

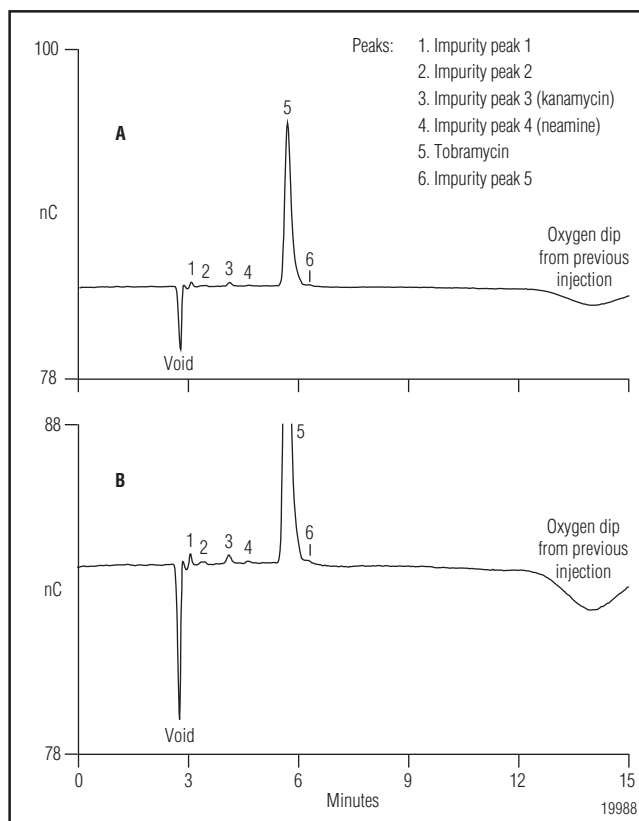

**Figure 3.** Determination of tobramycin ( $1.07\ \mu\text{M}$ ,  $20\text{-}\mu\text{L}$  injection) using eluent generation ( $2\ \text{mM KOH}$ ) with  $0.5\ \text{mL/min}$  flow rate,  $30\text{ }^{\circ}\text{C}$  column temperature, and AAA-Direct waveform. Full view (A) and expanded view of baseline (B).

to oxygen present in the samples and appears as a function of the gas permeation volume of the column. Like some organic impurities, eluting oxygen produces less background than the eluent, so there is a dip in the baseline. The retention times of the oxygen dip and other baseline dips vary from column to column, and depend on the flow rate, not the eluent strength. Eluting the baseline dips just prior to the end of run, or timing their elution to occur at the end of the following injection, prevents the baseline dips from interfering with the peaks of interest.

We investigated tobramycin separations using the CarboPac PA10, PA20, and MA1, and the AminoPac<sup>®</sup> PA10 columns, but found inadequate retention of tobramycin and kanamycin B on these columns. Substitution of the CarboPac PA1 guard column with the AminoTrap<sup>™</sup> column slightly increased retention times and broadened peaks.

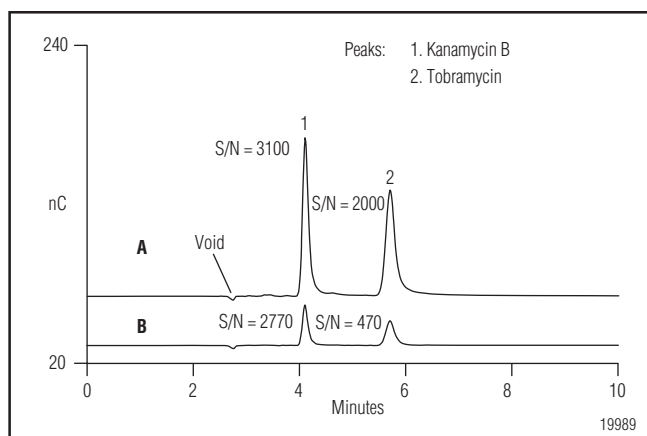
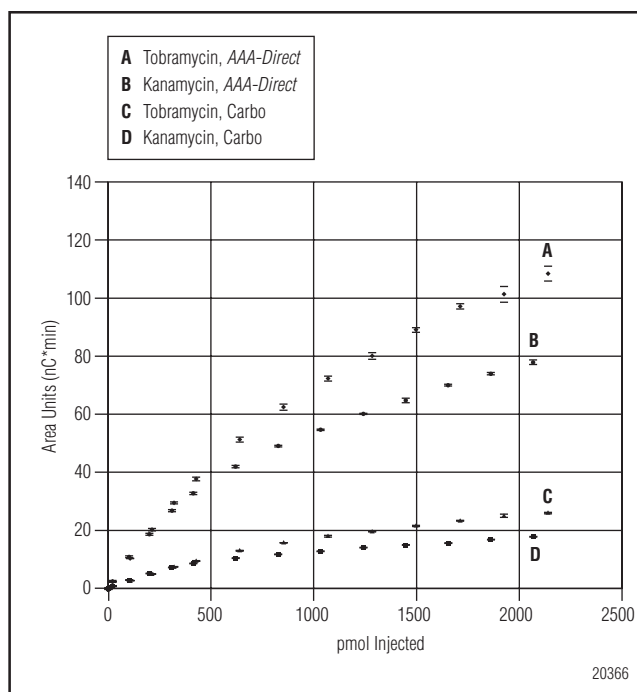

**Figure 4.** Comparison of 10  $\mu\text{M}$  tobramycin and kanamycin B peaks (20- $\mu\text{L}$  injection) using the AAA-Direct waveform (A) and the carbohydrate waveform (B).

The resolution (European Pharmacopoeia definition) between tobramycin and kanamycin B ranged from 5.80 and 6.16 over 7 days of consecutive analysis (mean  $\pm$  SD;  $6.00 \pm 0.07$ ,  $n = 572$ , 1.1% RSD). A European Pharmacopoeia method for tobramycin requires resolution to be greater than 3.0.<sup>2</sup> That method also allows adjustment of the mobile phase concentration to achieve this minimum resolution. The method presented in this application note easily achieves the resolution specification without mobile phase adjustment.

### Detection

Figure 4 compares the peak heights for 10  $\mu\text{M}$  tobramycin and kanamycin B (20- $\mu\text{L}$  injection) detected using (A) the AAA-Direct waveform, and (B) the carbohydrate waveform. The use of the AAA-Direct waveform increased signal-to-noise (S/N) 2 to 4 times, depending on system noise. The AAA-Direct waveform improved tobramycin sensitivity, which is required to maximize the detection of tobramycin impurities. When high sensitivity is not required, the carbohydrate waveform is recommended because it allows longer use of each disposable Au working electrode and improves day-to-day peak area reproducibility. The AAA-Direct Certified disposable Au working electrode is guaranteed for 1 week when used with the AAA-Direct waveform, and the Carbohydrate Certified disposable Au working electrode is guaranteed for 2 weeks when used with the carbohydrate waveform.



**Figure 5.** The relationship of peak area (mean  $\pm$  SD,  $n = 4$  injections each concentration) to mass of tobramycin and kanamycin B injected using the carbohydrate and AAA-Direct waveforms for estimation of linear range.

### Linear Range

Figure 5 presents the relationship of tobramycin and kanamycin B peak area ( $\text{pC} \cdot \text{min}$ ) to pmole of the analyte injected (20  $\mu\text{L}$ ) using the carbohydrate and AAA-Direct waveforms over a broad range of injections, 1–2200 pmol. Figure 6 shows the same data over a narrower range, 1–650 pmol, where the relationship of response to mass injected is linear. Figure 5 shows the effect of column or detector overload where response becomes nonlinear. In this application note, we consider the linear concentration range to be where the response factor (ratio of peak area/mass injected) remains within a 20% variance from the mean of its optimum level. A plot that relates area response factor to the mass injected (data not presented) showed a typical plateau region that represented an optimal level for operation. The corresponding mean tobramycin area response factor for this region was 22.6  $\text{nC} \cdot \text{min}/\text{pmol}$ , whereas the mean kanamycin B response factor was 24.4  $\text{nC} \cdot \text{min}/\text{pmol}$  using the carbohydrate waveform.

Tobramycin injections having response factors below 18.1 nC\*min/pmol (19.5 nC\*min/pmol for kanamycin B) were considered outside the upper linear range. These results (Table 1) show tobramycin peak area linearity extends up to 700 pmol (35  $\mu$ M for 20- $\mu$ L injection), and kanamycin B linearity extends up to 500 pmol (25  $\mu$ M for 20- $\mu$ L injection) using the carbohydrate waveform. Using the same waveform, the tobramycin peak height was linear to 500 pmol, and kanamycin B peak height was linear to 400 pmol. The linear range typically extended over 3 orders of magnitude (0.7–700 pmol tobramycin, carbohydrate waveform; 0.3–750 pmol tobramycin, *AAA-Direct* waveform) using the estimated lower limit of detection (LOD) as the lower end of the range.

The mean peak area response factors for the plateau region using the *AAA-Direct* waveform was 95.6 nC\*min/pmol for tobramycin and 98.1 nC\*min/pmol for kanamycin B. Tobramycin injections having response factors below 76.5 nC\*min/pmol (78.5 nC\*min/pmol for kanamycin B) were considered outside the upper linear range. Tobramycin peak area linearity extended up to 750 pmol (38  $\mu$ M for 20- $\mu$ L injection), and kanamycin B linearity extended up to 425 pmol (21  $\mu$ M for 20- $\mu$ L injection) using the *AAA-Direct* waveform. The tobramycin peak height was linear to 525 pmol, and kanamycin B peak height was linear to 350 pmol using this waveform. The peak area linear range for tobramycin extended over 3 orders of magnitude, and was slightly larger for the carbohydrate waveform.

### Linearity

Figure 6 shows the linear relationship of peak area response to mass of antibiotics injected for the concentrations ranging from near the lower limit of quantification to the upper limit of linearity. Masses ranging from 1 to 600 pmol produced a  $r^2$  value of 0.9946 for tobramycin and 0.9874 for kanamycin B using the carbohydrate waveform, 0.9935 and 0.9917 for tobramycin and kanamycin B, respectively, using the *AAA-Direct* waveform. Table 1 summarizes the statistics for these four calibration curves. Slopes for tobramycin and kanamycin B were nearly identical for each waveform, however, slopes were 3–4 times greater using the *AAA-Direct* waveform (see Figure 6). The nearly identical slopes for tobramycin and kanamycin B indicate that accurate measure of kanamycin B impurity is expected using peak area percentages of tobramycin, reducing the need to run separate kanamycin B standards.

**Table 1. Estimated Limits of Detection, Quantification, and Linearity for Tobramycin and Kanamycin B Using the Carbohydrate and *AAA-Direct* Waveforms**

<b>Carbohydrate Waveform</b>		
	<b>Tobramycin</b>	<b>Kanamycin B</b>
<b>Lower Limit Detection</b>		
pmol	0.55–2.26	0.34–1.39
$\mu$ M <sup>†</sup>	0.027–0.113	0.017–0.070
picogram	257–1055	164–673
$\mu$ g/mL <sup>†</sup>	0.013 – 0.053	0.008–0.034
<b>Lower Limit Quantitation</b>		
pmol	1.83–7.52	1.13–4.64
$\mu$ M <sup>†</sup>	0.091–0.376	0.056–0.232
picogram	855–3518	545–2243
$\mu$ g/mL <sup>†</sup>	0.043–0.176	0.027–0.112
<b>Upper Limit Linearity</b>		
pmol	700	500
$\mu$ M <sup>†</sup>	35	25
picogram	327000	242000
$\mu$ g/mL <sup>†</sup>	16	12
<b>Linearity Over Linear Range</b>		
$r^2$	0.9946	0.9874
Slope (nC*min/pmol)	0.0206	0.0215
<b><i>AAA-Direct</i> Waveform</b>		
	<b>Tobramycin</b>	<b>Kanamycin B</b>
<b>Lower Limit Detection</b>		
pmol	0.22–0.36	0.12–0.20
$\mu$ M <sup>†</sup>	0.011–0.018	0.006–0.010
picogram	102–167	59–97
$\mu$ g/mL <sup>†</sup>	0.005–0.008	0.003–0.005
<b>Lower Limit Quantitation</b>		
pmol	0.72–1.19	0.41–0.67
$\mu$ M <sup>†</sup>	0.036–0.060	0.020–0.034
picogram	339–558	197–325
$\mu$ g/mL <sup>†</sup>	0.017–0.028	0.010–0.016
<b>Upper Limit Linearity</b>		
pmol	750	425
$\mu$ M <sup>†</sup>	38	21
picogram	351000	206000
$\mu$ g/mL <sup>†</sup>	18	10
<b>Linearity Over Linear Range</b>		
$r^2$	0.9935	0.9917
Slope (nC*min/pmol)	0.0821	0.0814

<sup>†</sup> 20- $\mu$ L injections

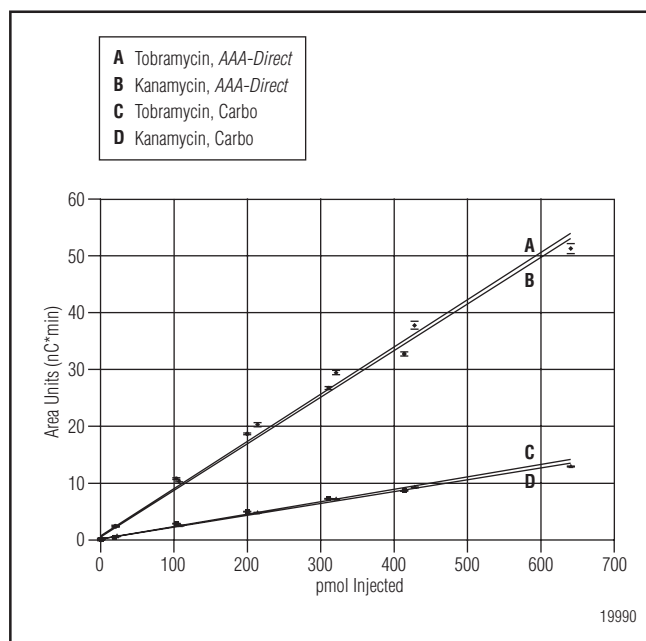

**Figure 6.** The linear relationship of tobramycin and kanamycin B peak area (mean  $\pm$  SD,  $n = 4$  injections each concentration) within their estimated linear range using the carbohydrate and AAA-Direct waveforms.

### Lower Limits of Detection and Quantification

In this study, baseline (peak-to-peak) noise was determined from noise measured in 1-min intervals during blank runs. Noise is measured in peak height units, pC. Baseline noise for the carbohydrate waveform ranged from 12 to 91 pC (mean  $\pm$  SD;  $38 \pm 21$ ,  $n = 218$  1-min intervals). Baseline noise for the AAA-Direct waveform ranged from 14 to 91 pC (mean  $\pm$  SD;  $37 \pm 15$ ,  $n = 308$  1-min intervals). After installing new disposable electrodes, baseline noise tended to decrease over the several days that noise was monitored. This trend was observed for both waveforms. Noise stabilized to its lowest level (lower end of the range) between 1–2 days of electrode use. A range of lower limits of detection (LOD) were calculated from the minimum and maximum measured baseline noise collected periodically over 3 days, starting 100 min after installation of a new electrode. The concentration (or mass injected) of tobramycin at the lower limit of detection (LOD) was calculated from three times the average peak-to-peak noise (a height value), divided by the average peak height response factor for the antibiotic within its linear region. At this concentration, signal-to-noise ratio equals 3. The lower limit of quantification (LOQ) is the concentration (or mass

injected) calculated from ten times the average peak-to-peak noise. The estimated LOD for tobramycin ranged from 0.55 to 2.3 pmol using the carbohydrate waveform, and ranged from 0.22 to 0.36 pmol using the AAA-Direct waveform using a 20- $\mu$ L injection. The estimated LOD for kanamycin B ranged from 0.34 to 1.4 pmol, and the LOQ ranged from 1.1 to 4.6 pmol using the carbohydrate waveform. The estimated LOD for kanamycin B ranged from 0.12 to 0.20 pmol, and the LOQ ranged from 0.41 to 0.67 pmol using the AAA-Direct waveform. Table 1 summarizes these results. Figure 7 shows tobramycin and kanamycin B at their respective LODs using the AAA-Direct waveform.

When tobramycin is analyzed at the upper range of linearity (Figure 8; 750 pmol), this method can detect 0.048–0.20 and 0.016–0.027 mole percent kanamycin B impurity using the carbohydrate and AAA-Direct waveforms, respectively. In Figure 8, kanamycin B is a 0.11% impurity of tobramycin.

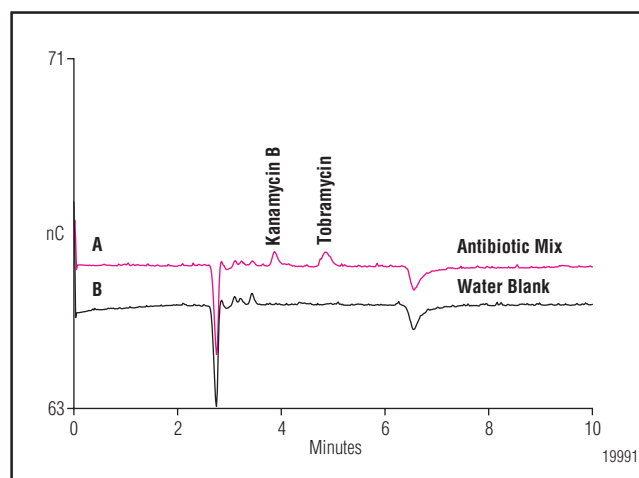

**Figure 7.** Determination of 0.22 pmol tobramycin (0.011  $\mu$ M) and 0.20 pmol kanamycin B (0.010  $\mu$ M) near their lower limits of detection (20- $\mu$ L injection).

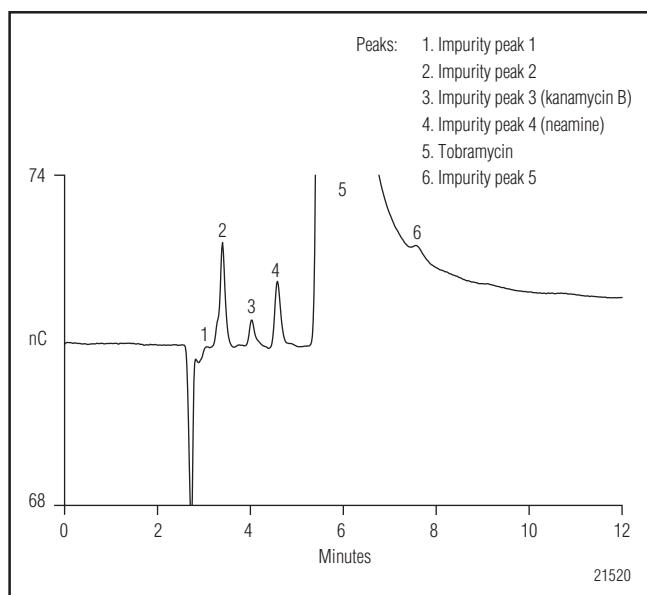

**Figure 8.** Determination of impurities when tobramycin is analyzed at the upper limit of linearity (0.038 mg/mL, 20- $\mu$ L injection) using the AAA-Direct waveform.

### Precision

The peak area and retention time RSDs were determined for replicate injections of a mixture of tobramycin and kanamycin B standards (10  $\mu$ M for 20- $\mu$ L injection) over 7 days (572 injections) for each waveform.

### Retention Time

The mean ( $\pm$  SD) retention time for tobramycin was  $5.74 \pm 0.02$  min over 7 days (572 injections), a 0.3% RSD. Kanamycin B retention time was  $4.12 \pm 0.01$  min, a 0.2% RSD. The daily retention time RSDs (over a 24-h period) ranged from 0.2 to 0.4 % for tobramycin and 0.2 to 0.3% for kanamycin B. Figure 9 presents the long-term (50 days, 2368 injections) retention time data for tobramycin and kanamycin B using the eluent generator for four 7-day studies. The long-term tobramycin retention time RSD was 0.3%, and kanamycin B was 0.4%. The periods of time without data in Figure 10 reflect periods where the system was either shut down or used for other experiments. No upward or downward trend was observed, and the precision was the same for each 7-day study. The column was regenerated for 1 h at 100 mM KOH once per week. The method described in this application note is designed to analyze a relatively pure antibiotic and can be used without any column regeneration for at least 7 days.

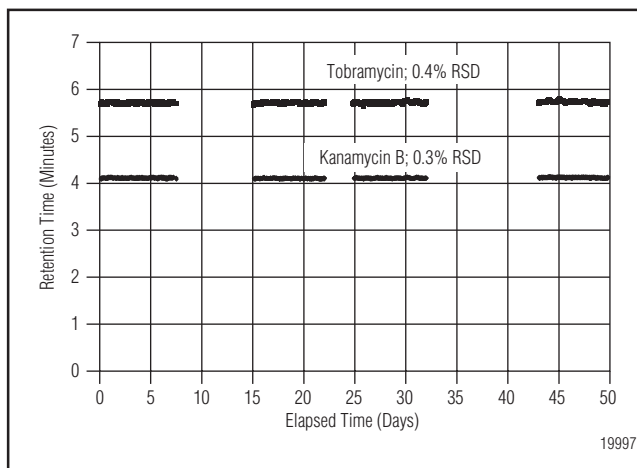

**Figure 9.** Reproducibility of tobramycin and kanamycin B retention time over 50 days using the eluent generator. Intervals without data represent periods when the system was either shut down, idle, or used for other tobramycin experiments.

### Peak Area

The peak area for tobramycin in the study described above ranged from 3.71 to 4.43 nC\*min (mean  $\pm$  SD;  $4.02 \pm 0.16$  nC\*min) with a 4.0% RSD using the carbohydrate waveform. Peak area for kanamycin B injected for 7 days ranged from 3.92 to 4.45 nC\*min (mean  $\pm$  SD;  $4.18 \pm 0.11$  nC\*min) with 2.6% RSD. A slight increase in peak areas (8% for tobramycin, 4% kanamycin B) was observed over 7 days.

A similar study was performed using the AAA-Direct waveform. The peak area for tobramycin ranged from 17.1 to 20.1 nC\*min (mean  $\pm$  SD;  $18.52 \pm 0.42$  nC\*min) with a 2.3% RSD. Peak area for kanamycin B ranged from 16.8 to 18.5 nC\*min (mean  $\pm$  SD;  $17.81 \pm 0.33$  nC) with 1.9 % RSD. An increasing trend in peak area was observed for both tobramycin and kanamycin B over the first 5 days, reaching a 4–5% change compared to day 1. Between 5 to 7 days, peak area trended back down to a 3% difference, compared to day 1.

Daily peak area RSDs ranged from 1.4 to 2.9% for the tobramycin and 1.2 to 1.8% for kanamycin B using the carbohydrate waveform. RSDs ranged 1.1–2.3% for the tobramycin and 0.8–1.7% for kanamycin B using the AAA-Direct waveform. The high retention time and response reproducibility indicate that this method is suitably rugged for this application.

Peak area precision is dependent on the concentration analyzed. As concentration approaches the LOQ and LOD, higher variance will be observed. This study used concentrations within the linear ranges for tobramycin and kanamycin B.



---

## Robustness

Robustness was evaluated for influence of a 10% variance in eluent concentration, different disposable Au working electrodes, a 10% variance in flow rate, and a column change.

### *Eluent Concentration*

The retention times of tobramycin and kanamycin B varied greatly with minor variations in mobile phase concentration. A 10% increase in KOH (2.2 mM) produced a retention time decrease to 4.7 min (–18% change from 2.0 mM) for tobramycin, whereas a 10% decrease in KOH (1.8 mM) produced a retention time increase to 7.8 min (+36% change). Kanamycin B retention time decreased by 9.2% with 10% increase in eluent concentration, and increased 17% with a 10% increase in eluent concentration. The large percent change in retention time for a relatively small change in KOH eluent concentration demonstrates the importance of producing a consistent eluent concentration, which the eluent generator achieves.

### *Disposable Gold Working Electrode Response*

Disposable electrodes were evaluated for their influence on response. Using the *AAA-Direct* waveform, with three *AAA-Direct* Certified electrodes from the same lot, tobramycin peak area response factors ranged from 83.6 to 94.8 pC\*min/pmol (based on 20  $\mu$ L of 10  $\mu$ M), mean  $\pm$  standard deviation of  $90.1 \pm 5.8$  (6.5%). Kanamycin B peak area response factors ranged from 83.3 to 92.9 pC\*min/pmol (based on 20  $\mu$ L of 10  $\mu$ M), mean  $\pm$  standard deviation of  $88.5 \pm 4.8$  (5.5%). Using the *AAA-Direct* waveform, with four *AAA-Direct* Certified electrodes from different lots, tobramycin response factors ranged from 73.7 to 90.1 pC\*min/pmol, mean  $\pm$  standard deviation of  $83.8 \pm 7.1$  (8.5%). Kanamycin B response factors ranged from 75.5 to 88.5 pC\*min/pmol, mean  $\pm$  standard deviation of  $83.6 \pm 5.7$  (6.8%).

Using the carbohydrate waveform, with four Carbohydrate Certified electrodes from the same lot, tobramycin peak area response factors ranged from 19.8

to 22.9 pC\*min/pmol (based on 20  $\mu$ L of 10  $\mu$ M), mean  $\pm$  standard deviation of  $21.3 \pm 1.7$  (8.1%). Kanamycin B peak area response factors ranged (three different electrodes) from 21.0 to 25.4 pC\*min/pmol (based on 20  $\mu$ L of 10  $\mu$ M), mean  $\pm$  standard deviation of  $23.0 \pm 2.2$  (9.6 %RSD). Using the carbohydrate waveform, with five Carbohydrate Certified electrodes from different lots, tobramycin response factors ranged from 21.3 to 25.6 pC\*min/pmol, mean  $\pm$  standard deviation of  $23.6 \pm 1.9$  (8.1%). Kanamycin B response factors (5 electrodes) ranged from 21.5 to 24.8 pC\*min/pmol, mean  $\pm$  standard deviation of  $23.1 \pm 1.2$  (5.1%).

### *Flow Rate*

A 10% change in the operating column flow rate (0.50 mL/min) was evaluated for influence on tobramycin and kanamycin B retention time. At 10% higher flow rate, a 5–7% decrease in retention time was observed, and at 10% lower flow rate, a 13–14% increase in retention time was observed. At 10% higher flow rate, no significant change in peak area was observed, and at 10% lower flow rate, a 12–13% increase in peak area was observed using the *AAA-Direct* waveform. A 10% change in flow rate did not affect noise. The carbohydrate waveform was not investigated for these effects.

### Column Reproducibility

The tobramycin retention time RSD for four separate columns was 7.0 %, whereas kanamycin B retention time RSD was 3.1% and neamine was 6.1%.

Retention times of baseline dips also vary slightly from column to column, and may change over the long-term (6–12 months) use of the column. Baseline dips do not interfere with determination of impurities. If the determination of a trace level of tobramycin is the analytical objective, and the tobramycin peak coincidentally coelutes with the first baseline dip (at ~6 min) using 2.00 mM KOH, or the same retention times are desired from column to column, then KOH concentration may be adjusted as shown in Figure 10. Alterna-

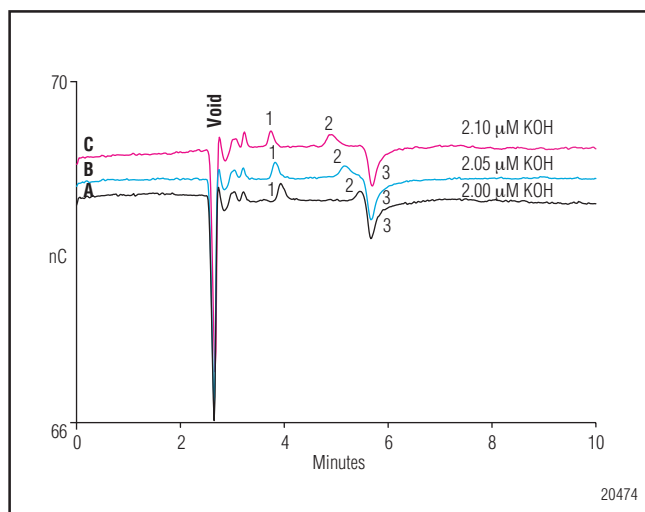

**Figure 10.** Effect of minor adjustments in KOH concentration on the separation of the tobramycin (peak 2) from the first baseline dip (peak 3). Mixture of tobramycin (0.011  $\mu\text{M}$ ) and kanamycin B (peak 1; 0.010  $\mu\text{M}$ ) near their lower limits of detection using (A) 2.00 mM KOH, (B) 2.05 mM KOH, and (C) 2.10 mM KOH (20- $\mu\text{L}$  injection).

tively, replacement of the guard column, analytical column, or both can often correct this coelution. In this study, the peak area of the baseline dip 1 (a negative peak) at about 6 min was equivalent to  $0.92 \pm 0.42$  pmol tobramycin ( $0.046 \pm 0.021$   $\mu\text{M}$ , 20- $\mu\text{L}$  injection,  $n = 28$  measures over 287 days). If tobramycin coeluted with this dip, the error contribution of this dip was estimated to be insignificant at tobramycin concentrations above ~100 pmol (5  $\mu\text{M}$ , 20- $\mu\text{L}$  injection).

### Sample Matrix

Salt exceeding 5 mM in the sample may cause retention time shifts in tobramycin and kanamycin and distort peaks. For some pharmaceutical formulations, a periodic column wash more frequent than every 7 days may be necessary, and will depend on the nature of the ingredients. At this time, we do not recommend this method for applications other than assessing the quality of pure tobramycin.

### Instrument Operational Considerations

Weekly column washes at 100 mM KOH are recommended to restore retention times for tobramycin and kanamycin B when the system is used without column regeneration. The application of 100 mM KOH changes system equilibrium, and reequilibration at 2 mM KOH for 2 h is recommended to achieve high precision.

When the system is idle for short (1–2 week) periods, we recommend that the pump and eluent generator be left on at 0.5 mL/min or at a reduced flow rate to achieve rapid start-up. The cell should be turned off to extend disposable electrode life. The use of a lower flow rate, while maintaining the minimum backpressure of at least 2000 psi, extends the interval before water must be added to the reservoir. When the system must be shut down for a period of several weeks, the pump, eluent generator, and electrochemical cell may be turned off. For shutdown periods exceeding several weeks, all plumbing lines should be reconnected and the reference electrode should be removed from the electrochemical cell and stored in the original solution shipped with the reference electrode (saturated KCl). When the pump has been turned off for longer than

1 day, the column should be regenerated with 100 mM KOH for 1–2 h, and reequilibrated with 2 mM KOH for 2 h before analyzing samples.

## CONCLUSION

HPLC-PAD with eluent generation can be used to determine tobramycin and its impurities. The linear range of electrochemical response extended over 3 orders of magnitude, from 0.03–0.11  $\mu\text{M}$  (LOD) up to 35  $\mu\text{M}$  (16  $\mu\text{g}/\text{mL}$ ; 20- $\mu\text{L}$  injection) for the carbohydrate waveform, and from 0.01–0.02  $\mu\text{M}$  (LOD) up to 38  $\mu\text{M}$  (18  $\mu\text{g}/\text{mL}$ ; 20- $\mu\text{L}$  injection) for the AAA-Direct waveform. Both the carbohydrate and AAA-Direct waveforms showed equivalent noise and linear range; however, the AAA-Direct waveform had 3–4 times greater response, and therefore had lower limits of detection. High-precision method ruggedness is possible for this antibiotic and impurities using either waveform, but the carbohydrate waveform—with its corresponding disposable electrode—provides longer guaranteed response stability. The recommended waveform choice (and corresponding disposable electrode) is based on the analytical requirements. The eluent generator makes this method reproducible and rugged with respect to retention time and peak separation. Because the pump is only required to pump water and no caustic eluent preparation is required, there is reduced pump seal wear and increased safety for the analyst. The disposable gold working electrodes provide consistently high detector response, assuring greater instrument-to-instrument and lab-to-lab reproducibility.

## REFERENCES

1. *Physicians' Desk Reference* PDR 44th Edition, Edward R. Barnhart, publisher; Medical Economics Company, Inc., Oradell, NJ; 1990.
2. European Pharmacopia (EP). Fifth Edition, Tobramycin. Section 0645. The Council of Europe, 67075 Strasbourg Cedex, France, 2004; [www.pheur.org](http://www.pheur.org).
3. Szunyog, J.; Adams, E.; Roets, E.; Hoogmartens, J. "Analysis of Tobramycin by Liquid Chromatography with Pulsed Electrochemical Detection." *J. Pharm. Biomed. Anal.* **2000**, *23*, 891–896.
4. Polta, J. A.; Johnson, D. C.; Merkel, K. E. "Liquid-Chromatographic Separation of Aminoglycosides with Pulsed Amperometric Detection." *J. Chromatogr.* **1985**, *324*, 407–414.
5. Dionex Corporation. *Tobramycin in Pharmaceutical Formulations*. Application Note 61 (LPN #034289, September 1989); Sunnyvale, CA.
6. Statler, J. A. "Determination of Tobramycin Using High-Performance Liquid Chromatography with Pulsed Amperometric Detection." *J. Chromatogr.* **1990**, *92*, 244–246.
7. Cheng, J., Jandik, P. and Avdalovic, N. "Development and Characterization of Microfabricated Disposable Gold Working Electrodes for High-Performance Ion Chromatography and Integrated Pulsed Amperometric Detection." *Anal. Chem.* **2003**, *75*, 572–579.
8. Cheng, J., Jandik, P. and Avdalovic, N. "Use of Disposable Gold Working Electrodes for Cation Chromatography-Integrated Pulsed Amperometric Detection of Sulfur-Containing Amino Acids." *J. Chromatogr. A*, **2003**, *997*, 73–78.
9. International Conference on Harmonisation of Technical Requirements for Registration of Pharmaceuticals for Human Use. ICH Harmonised Tripartite Guideline. Text on Validation of Analytical Procedures. Q2A. Recommended for Adoption at Step 4 of the ICH Process on 24 October 1994 by the ICH Steering Committee. [www.ICH.org](http://www.ICH.org)
10. International Conference on Harmonisation of Technical Requirements for Registration of Pharmaceuticals for Human Use. ICH Harmonised Tripartite Guideline. Validation of Analytical Procedures: Methodology. Q2B. Recommended for Adoption at Step 4 of the ICH Process on 6 November 1996 by the ICH Steering Committee. [www.ICH.org](http://www.ICH.org)
11. U.S. Department of Health and Human Services, Food and Drug Administration, Center for Drug Evaluation and Research (CDER), Center for Biologics Evaluation and Research (CBER) "Guidance for Industry. Analytical Procedures and Method Validation. Chemistry, Manufacturing, and Controls Documentation." Draft guidance. August, 2000. <http://www.fda.gov/cder/guidance/2396dft.htm>
12. U.S. Department of Health and Human Services, Food and Drug Administration, Center for Drug Evaluation and Research (CDER) "Reviewer Guidance. Validation of Chromatographic Methods." November 1994. <http://www.fda.gov/cder/guidance/cmc3.pdf>

13. U.S. Department of Health and Human Services, Food and Drug Administration, Center for Drug Evaluation and Research (CDER) "Guideline for Submitting Samples and Analytical Data for Methods Validation." February 1987.  
<http://www.fda.gov/cder/guidance/ameth.htm>
14. U.S. Department of Health and Human Services, Food and Drug Administration, Center for Drug Evaluation and Research (CDER), Center for Veterinary Medicine (CVM) "Guidance for Industry. Bioanalytical Method Validation." May 2001.  
<http://www.fda.gov/cder/guidance/4252fnl.pdf>
15. United States Pharmacopeia, The National Formulary. "<1225> Validation of Compendial Methods." USP 27, NF 22; 2004, pps. 2622–2625.
16. United States Pharmacopeia, The National Formulary. "<621> Chromatography." USP 27, NF 22; 2004, pps. 2272–2284.
17. Dionex Corporation. "Optimal Settings for Pulsed Amperometric Detection of Carbohydrates using the Dionex ED40 Electrochemical Detector." Technical Note 21; Sunnyvale, CA.
18. Dionex Corporation. *Product Manual: AAA-Direct Amino Acid Analysis System*. Sunnyvale, CA.

## LIST OF SUPPLIERS

J. T. Baker, 222 Red School Lane, Phillipsburg, NJ 08865 USA, Tel: 800-582-2537, [www.jtbaker.com](http://www.jtbaker.com).  
Fisher Scientific, 2000 Park Lane, Pittsburgh, PA 15275-1126 USA, Tel: 800-766-7000, [www.fishersci.com](http://www.fishersci.com).  
Sigma Chemical Company, P.O. Box 14508, St. Louis, MO 63178 USA, Tel: 1-800-325-3010, [www.sigma-aldrich.com](http://www.sigma-aldrich.com).  
Praxair Specialty Gases and Equipment, 39 Old Ridgebury Road, Dansbury, CT 06810-5113 USA, Tel: 877-772-9247 and 716-879-4077, [www.praxair.com/specialtygases](http://www.praxair.com/specialtygases).  
World Health Organization (WHO) Collaborating Centre for Chemical Reference Substances; Apoteket AB; Produktion & Laboratories; Centrallaboratoriet, ACL; PrismavAgen 2; SE-141 75 Kungens Kurva, Sweden, Fax: + 46 8 740 60 40, [who.apl@apoteket.se](mailto:who.apl@apoteket.se), [www.who.int/medicines/strategy/quality\\_safety/trs917annl.pdf](http://www.who.int/medicines/strategy/quality_safety/trs917annl.pdf).



CarboPac and AAA-Direct are trademarks, and BioLC, Chromeleon, and AminoPac are registered trademark of Dionex Corporation.

### Dionex Corporation

1228 Titan Way  
P.O. Box 3603  
Sunnyvale, CA  
94088-3603  
(408) 737-0700

### Dionex Corporation

Salt Lake City Technical Center  
1515 West 2200 South, Suite A  
Salt Lake City, UT  
84119-1484  
(801) 972-9292

### Dionex U.S. Regional Offices

Sunnyvale, CA (408) 737-8522  
Westmont, IL (630) 789-3660  
Houston, TX (281) 847-5652  
Allanta, GA 432-8100  
Marlton, NJ (856) 596-06009

### Dionex International Subsidiaries

Australia 61 (2) 9420 5233 Austria (01) 616 51 25 Belgium (03) 353 42 94 Canada (905) 844-9650 China (852) 2428 3282  
Denmark 36 36 90 90 France 01 39 30 01 10 Germany 06126-991-0 Italy (06) 66 51 50 52 Japan (06) 6885-1213  
Korea 82 2 2653 2580 The Netherlands (0161) 43 43 03 Switzerland (062) 205 99 66 United Kingdom (01276) 691722