



Agilent BioHPLC Column Selection Guide

YOUR REFERENCE GUIDE TO THE ANALYSIS OF BIOPHARMACEUTICALS AND BIOMOLECULES



Agilent Technologies



Table of Contents

Biocolumn Selection Guidelines	1	Protein Depletion	129
Biomolecule Separations	6	Agilent Protein Fractionation Systems and Proteomics Reagents	129
Method Development Guidelines	19	Multiple Affinity Removal System	130
Primary Structure Analysis Methods	19	Multiple Affinity Removal System Starter Kits	133
Reversed-Phase LC/MS Methods	21	Specialty Dimensions	134
Charge Variant Analysis Methods	22	Capillary and Nano LC Columns	134
Aggregation and Fragment Analysis Methods	25	ZORBAX Bio-SCX Series II	139
Glycan and Hydrophilic/Glycopeptide Analysis Methods	27	MicroBore (1.0 mm id) Columns	141
Titer Determination and Cell Culture Optimization Methods	28	2D-LC	144
High Sensitivity Capillary Column Methods	29	Purification – Prep HPLC	148
Agilent Instrumentation for Protein Identification and Impurity Profiling	30	mRP-C18 High-Recovery Protein Columns	150
Primary Structure Analysis	32	ZORBAX PrepHT	152
AdvanceBio RP-mAb	34	PLRP-S for Prep to Process	154
ZORBAX 300Å StableBond	39	Agilent Bio MAb and Agilent Bio IEX	159
ZORBAX 300Å Extend-C18	47	PL-SAX and PL-SCX for Prep to Process	161
Poroshell 300	51	Peptide Purification	164
AdvanceBio Peptide Mapping	56	VariTide RPC Columns for Synthetic Peptides	164
PLRP-S	61	VariPure IPE	165
ZORBAX Amino Acid Analysis (AAA) Columns and Supplies	68	Load & Lock Preparative HPLC Column Packing Systems	166
Charge Variant Analysis	71	Laboratory Load & Lock Columns	166
Agilent Bio MAb HPLC Columns	74	Agilent Bio SEC	167
Agilent Bio IEX HPLC Columns	80	BioHPLC Resources	169
PL-SAX Strong Anion-Exchange Columns	86	Cartridge Column Systems	169
PL-SCX Strong Cation-Exchange Columns	90	Cartridge/Guard Cartridge Systems Compatibility Guide	170
Agilent Bio-Monolith Ion-Exchange HPLC Columns	92	USP Designation – BioHPLC Columns Only	171
Aggregation and Fragment Analysis	96	BioHPLC Columns Literature	172
Agilent Bio SEC-3	99	BioPharm Definitions	182
Agilent Bio SEC-5	105	Citations	194
ProSEC 300S	109	AdvanceBio Peptide Mapping	194
ZORBAX GF-250 and GF-450 Gel Filtration Columns	112	Bio SEC	194
Glycosylation Characterization	115	Bio-Monolith	194
N-Glycan Analysis	116	PLRP-S	195
N-Glycan Standards	119	PL-SAX	197
N-Glycan Sample Preparation	120	PL-SCX	197
Hydrophilic and Glycopeptide Analysis	123	Poroshell 300	198
Titer Determination	125	ZORBAX 300	199
Agilent Bio-Monolith Protein A HPLC Columns	125		

BIOCOLUMN SELECTION GUIDELINES

Biotherapeutics have enormous potential to improve human health. The number of approved protein and antibody therapeutics continues to grow around the world as this important therapeutic class addresses unmet medical needs. But discovery and development of biopharmaceuticals is difficult. You face a variety of challenges and must not only stay abreast of advances in knowledge and improvements in technology, but also navigate the maze of shifting government regulations. Making good decisions fast is critical. At every stage in the process, from disease research to QA/QC and manufacturing, Agilent can help you make the right choices for moving therapeutics successfully to market. And it's not just because we build reliable instruments and consumables that provide accurate, reproducible results. We understand the biopharmaceutical workflow and provide families of products that work together seamlessly – as engines of research, discovery, and development – to move candidate biopharmaceuticals forward.

Given that protein biopharmaceuticals are very heterogeneous, they will require a number of chromatographic methods to accurately characterize the active pharmaceutical ingredient (API). Methods include size exclusion chromatography for the quantitation of dimers and aggregates, and ion-exchange chromatography for charge variant analysis. As part of the full characterization, it will be necessary to look at primary amino acid sequence and any post-translational modification to the sequence that may occur during purification or formulation steps. To enable complete, reproducible, and high-quality analysis for key characterization workflows, Agilent provides a broad range of columns and supplies.

This comprehensive guide will help you find the right column for your characterization workflow. We have also included advice and tips on method development, solvent choice, mobile phase modification, optimization, and many example separations, all to assist you in column selection and method development.

Agilent has complete solutions for your needs. These include the Agilent 1260 Infinity Bio-inert Quaternary LC with a metal-free sample path and the Agilent 1290 Infinity LC, designed to provide highest speed, resolution, and ultra-sensitivity for UHPLC applications, including those using Agilent wide-pore ZORBAX 300Å StableBond columns. Biomolecules may be complex in structure, but their analysis is simplified by using Agilent HPLC columns, systems, and supplies.

What is a biomolecule?

Biomolecules are compounds made by living organisms. They can range in size from amino acids and small lipids to large polynucleotides such as DNA or RNA.

In this section, we deal with the separation of:

Proteins – separation based on size with size exclusion chromatography, charge with ion-exchange chromatography, and hydrophobicity with reversed-phase chromatography.

Peptides – biocolumns for the analysis and purification of the full range of peptides, including hydrophobic, hydrophilic, basic, and acidic peptides across the full size range. Also, columns for peptide mapping by HPLC and UHPLC.

DNA/RNA oligonucleotides – reversed-phase and ion-exchange options for DNA and RNA oligos, and with particle pore sizes to cover the full range of oligonucleotide sizes, from small synthetic oligos to large plasmids.

Amino acids – the ZORBAX Eclipse Amino Acid Analysis HPLC columns provide a high efficiency solution for analysis of 24 amino acids. Typical analysis times range from 14 minutes, with a 75 mm column, to 24 minutes with a 150 mm column.

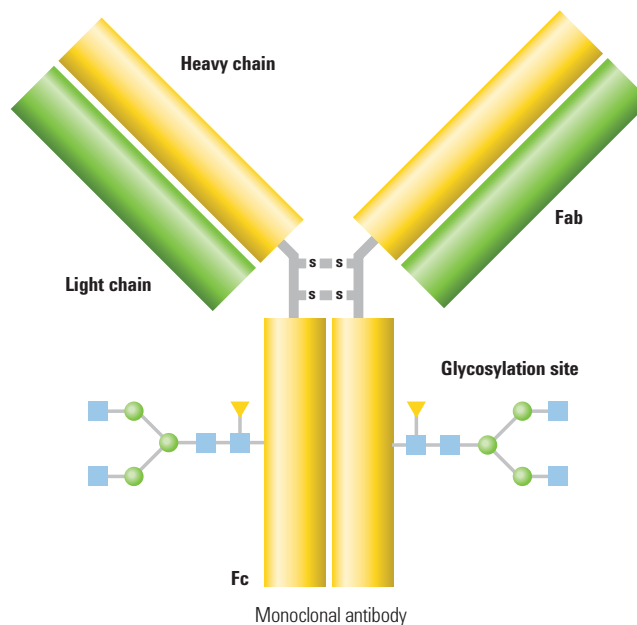

What is a biocolumn?

Biochromatography columns, or biocolumns, are liquid chromatography columns used for the separation of biological compounds such as peptides and proteins, oligonucleotides and polynucleotides, and other biomolecules and complexes. Biocolumns are specifically designed for biomolecule analysis with larger pore sizes to accommodate the larger molecule sizes. Media are designed to minimize nonspecific binding of analytes for improved recovery. Separation mechanisms are chosen to either retain biological function so bioactivity is not lost during analysis, or to deliberately denature for primary structure characterization.

Agilent's biocolumn offering provides solutions for all the major characterization techniques required for your biomolecule analysis. These include:

Titer determination and purification: Use unique technology such as AdvanceBio Bio-Monolith Protein A to perform titer determination and cell line optimization.

Intact and post-translational modification: Use key technologies such as AdvanceBio RP-mAb, ZORBAX RRHD 300Å, Poroshell 300, and AdvanceBio Peptide Mapping for confidence in results from primary structural characterization through analysis of intact or fragmented proteins.

Aggregation: Agilent Bio SEC-3 and Agilent Bio SEC-5 accurately measure aggregates (dimers, trimers, tetramers, etc.) and separate low molecular excipients and impurities from larger molecular weight proteins.

Charge variants: Agilent ion-exchange columns include optimized chemistries for monoclonal antibody analysis, such as Agilent Bio MAb and Agilent Bio IEX for accurate isoform analysis.

Glycosylation characterization: Agilent hydrophilic interaction chromatography (HILIC) columns deliver accurate and reproducible glycan and glycopeptide analysis.

Special applications: Includes robust, high efficiency solution for amino acid analysis through ZORBAX Eclipse AAA column and solutions for DNA/RNA analysis.





Recently, Agilent has introduced the AdvanceBio family to enable protein and mAb characterization. Agilent AdvanceBio columns are designed to advance accuracy and speed for your characterization of monoclonal antibodies and other intact proteins, aggregation with SEC, charge variants with IEX, intact mass, primary structure, and post-translational modifications (PTMs) by reversed-phase, and cleaved glycan analysis by hydrophilic interaction chromatography.

This guide provides more details on the complete Agilent biocolumn portfolio, along with information on choices within the AdvanceBio family to accurately characterize biotherapeutics.



TIPS & TOOLS

To learn more about our AdvanceBio family of columns and various tools to advance your characterization needs, visit www.agilent.com/chem/advancebio

Column Selection Flow Chart

The flow chart below indicates the page numbers that will take you to the selection guides in the individual chapters to help you choose the best column for your biomolecule application.

There are a number of guidelines that can be followed to assist in the selection of the optimum column for a biomolecule separation. The starting point is the size of the molecule, as this determines the pore size of the HPLC method used for the separation. Secondly, consider the solubility of the molecule. Thirdly, note the separation mechanism, size, hydrophobicity, and charge.

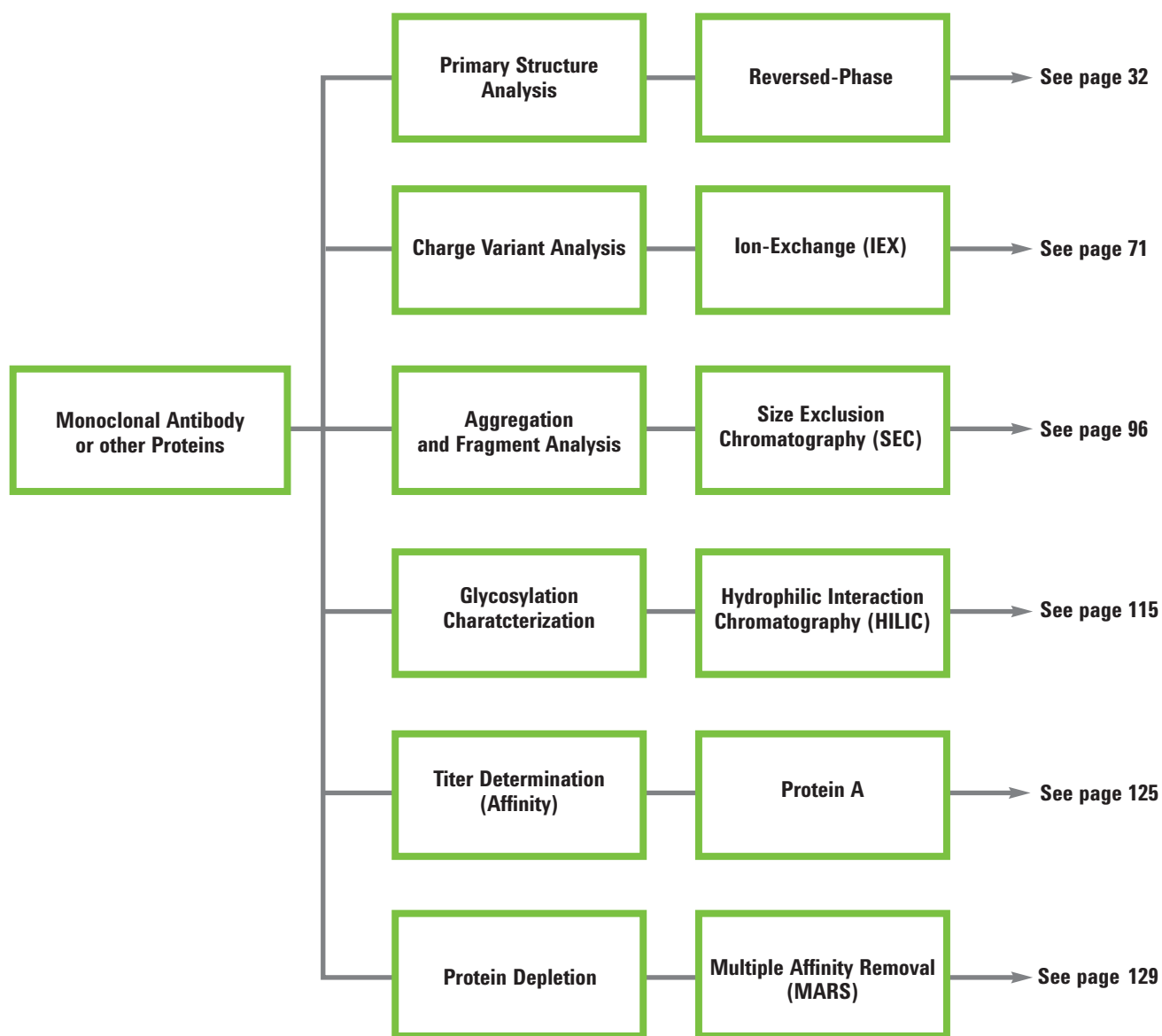

BIOMOLECULE SEPARATIONS

Protein Separations

Proteins are complex molecules that require multiple techniques to provide full characterization. They exist as three-dimensional structures and it is this structure that confers their biological activity.

The sequence of the amino acid chains defines the primary structure of the protein. Hydrogen bonding between amino acids of the primary structure then confers a secondary structure, typically in the form of alpha helices and pleated sheets. A further series of interactions, hydrogen bonding, ionic, hydrophobic, and disulphide bridges, between regions of the secondary structure, then provides the tertiary protein structure, or three-dimensional conformation. If the protein is composed of a number of amino acid chains, the interaction between these chains gives the quaternary structure.

When looking at methods for protein characterization, it is therefore clear from **Figure 1** that techniques will be required that characterize the protein in its native state, without disrupting the tertiary and quaternary structures. We also need techniques for assessing the primary amino acid sequence, in the fully denatured state with the three-dimensional structure stripped away.

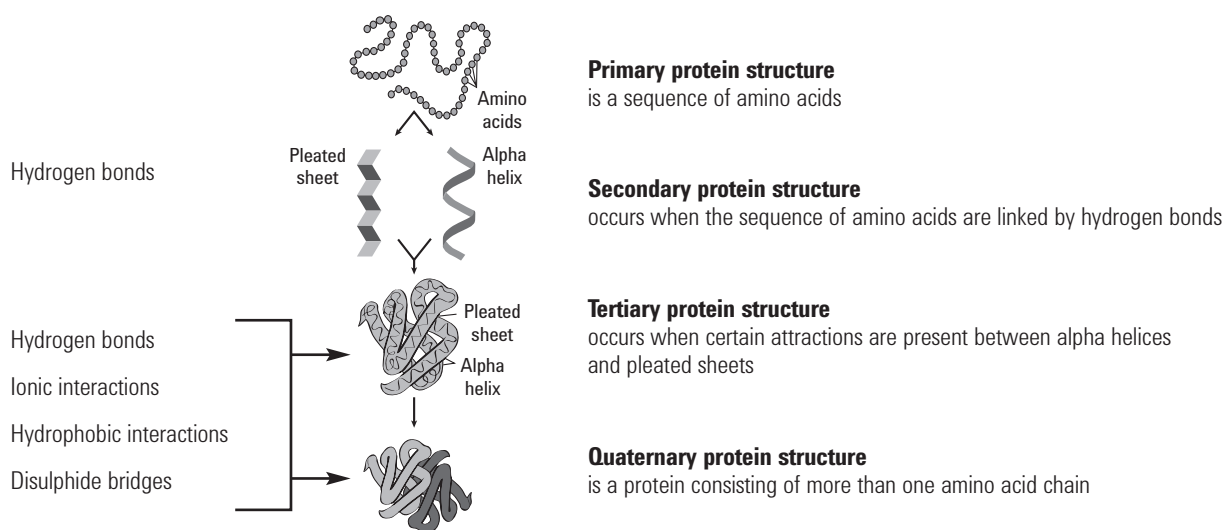

Figure 1. Schematic showing the various levels of protein structure.

The environment of the protein can influence, stabilize, or disrupt its structure. Factors to consider include pH, temperature, salt concentrations, aqueous or organic solvent content, and for some proteins, the presence of a stabilizing small molecule or metal ions. Protein structure can also be disrupted by the use of sulfhydryl reducing agents to break -S-S- bonds or chaotropic agents, such as urea or guanidine HCl. With the complexity of proteins and the intramolecular interactions that determine the three-dimensional structure, you can also expect that there will be intermolecular associations between protein molecules and other molecular entities and the surfaces with which they come into contact. This can result in protein complexes, aggregation (with possible precipitation), and deposition on surfaces, including those of the HPLC column and system. Therefore, you should consider the handling and environment in which the protein is maintained.

Protein Column Selection Guide

Application	Technique	Agilent Columns	Notes
Primary structure analysis	UHPLC/HPLC reversed-phase separations	AdvanceBio RP-mAb ZORBAX RRHD 300Å Poroshell 300Å ZORBAX 300Å AdvanceBio Peptide Mapping PLRP-S	Reversed-phase separations require (or cause) denaturing of the protein to obtain detailed information about the amino acid sequence and/or amino acid modifications (including post-translational modifications).
Charge variant analysis	Ion-exchange separations	Agilent Bio IEX Agilent Bio MAb PL-SAX PL-SCX	The ratio of individual amino acids determines the net charge of the protein molecule. The pH at which the net charge is zero is called the isoelectric point (pI). When the solution pH is less than the pI, the protein will be positively charged (acidic), and when the solution pH is greater than the pI, the protein is negatively charged (basic). For ion-exchange analysis, we recommend the eluent pH be at least one pH unit away from its pI. Protein analysis using ion-exchange columns requires buffered mobile phase and either salt gradients or pH gradients for elution.
Aggregation and fragment analysis	Size exclusion separations	Bio SEC-3 Bio SEC-5 ProSEC 300S ZORBAX GF	Aggregates in protein biopharmaceuticals are of major concern as they can induce an immunogenic response and can influence the composition of the final formulation.
Glycosylation characterization	Hydrophilic interaction chromatography	AdvanceBio Glycan Mapping ZORBAX RRHD 300 HILIC	Understanding glycosylation and glycan structures of proteins and mAbs is growing in importance due to the effect of immunogenicity and safety of the biotherapeutic. HILIC chromatography provides orthogonal information to reversed-phase columns as it retains the hydrophilic portion of the sample.
Titer determination	Affinity separation	AdvanceBio Bio-Monolith Protein A	To monitor monoclonal antibody titer and yield from cell-culture supernatants before expensive preparative and large amounts of protein A are employed, a small (analytical) scale procedure is necessary to determine the titer of monoclonal antibody for the optimal time for harvest of the monoclonal antibody products.
Protein depletion	Affinity purification	MARS Human-14 MARS Human-7 MARS Human-6 MARS Human-6 High Capacity MARS Human-2 MARS Human-1 MARS Mouse-3	Remove the high-abundance proteins from biological samples. Removal of these abundant proteins improves the subsequent LC/MS and electrophoretic analysis of the sample by effectively expanding the dynamic range.

High speed, high resolution separation of Herceptin Variant IgG1

Column: AdvanceBio RP-mAb C4
795775-904
2.1 x 100 mm, 3.5 µm

Mobile Phase: A: 0.1% TFA in water:IPA (98:2)
B: IPA:ACN:Mobile phase A (70:20:10)

Flow Rate: 1.0 mL/min

Gradient: 10-58% B in 4 min, 1 min wash at 95% B,
1 min re-equilibration at 10% B

Temperature: 80 °C

Detector: UV, 254 nm

Sample: 5 µL injection of humanized recombinant Herceptin Variant IgG1 intact from Creative Biolabs (1 mg/mL)

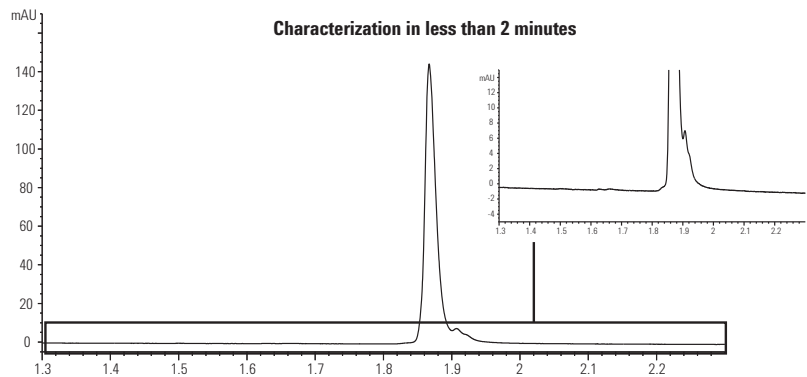

AdvanceBio RP-mAb C4 provides a sharp peak and resolves fine detail in less than 2 minutes.

Higher resolution of oxidation

Column: ZORBAX RRHD 300SB-C18
857750-902
2.1 x 50 mm, 1.8 µm

Mobile Phase: A: 0.1% TFA
B: 0.01% TFA + 80% ACN

Flow Rate: 1.0 mL/min

Gradient: 33 to 50% B, 0 to 4 min

Detector: 1290 Infinity LC with diode array detector at 280 nm

Sample: Insulin, insulin chain A and chain B, oxidized (BSA, Sigma-Aldrich, Corp., 1 mg/mL)

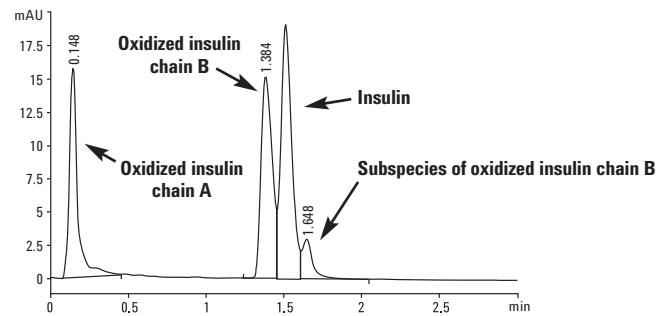

Oxidized insulin chains are resolved from insulin in under 2 minutes using the Agilent ZORBAX RRHD 300SB-C18 2.1 x 50 mm, 1.8 µm column.

Intact mAb monomer and dimer separation

Column: Bio SEC-3, 300Å
5190-2511
7.8 x 300 mm, 3 µm

Buffer: Sodium phosphate buffer 150 mM, pH 7.0

Isocratic: 0-100% Buffer from 0-30 min

Flow Rate: 1.0 mL/min

Sample: CHO-humanized mAb, 5 mg/mL – intact

Injection: 5 µL

Detector: UV, 220 nm

Temperature: Ambient

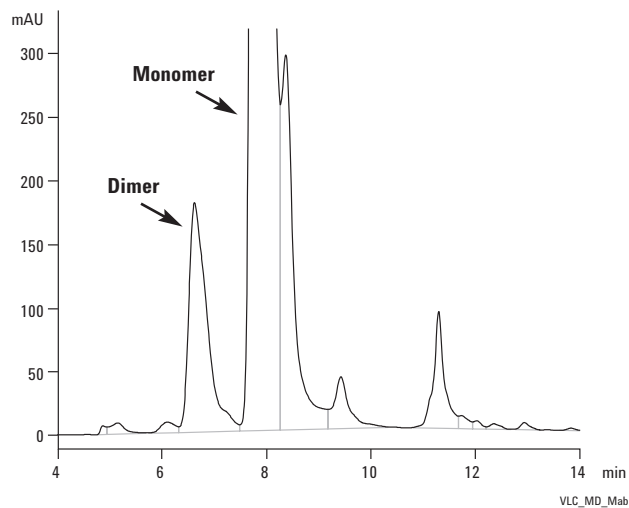
**TIPS & TOOLS**

Agilent recognizes the extraordinarily complicated and labor intensive work that you do. We can help. Further information can be found in *BioPharma Workflow Solutions: How Agilent Helps Resolve Complex Analytical Challenges* (publication 5991-5235EN)

www.agilent.com/chem/library

Separation of charge variants of human IgG1 with salt gradient

Column: Bio MAb, PEEK
5190-2407
4.6 x 250 mm, 5 µm

Mobile Phase: A: 10 mM Na₂HPO₄, pH 5.5
B: A + 0.5 M NaCl

Flow Rate: 0.85 mL/min

Gradient: 10 to 35% B from 0 to 25 min

Detector: UV, 225 nm

Sample: 5 µL of 1 mg/mL of intact or C-terminal digested IgG1

Instrument: Agilent 1260 Infinity Bio-inert Quaternary LC or
Agilent 1100 Series LC

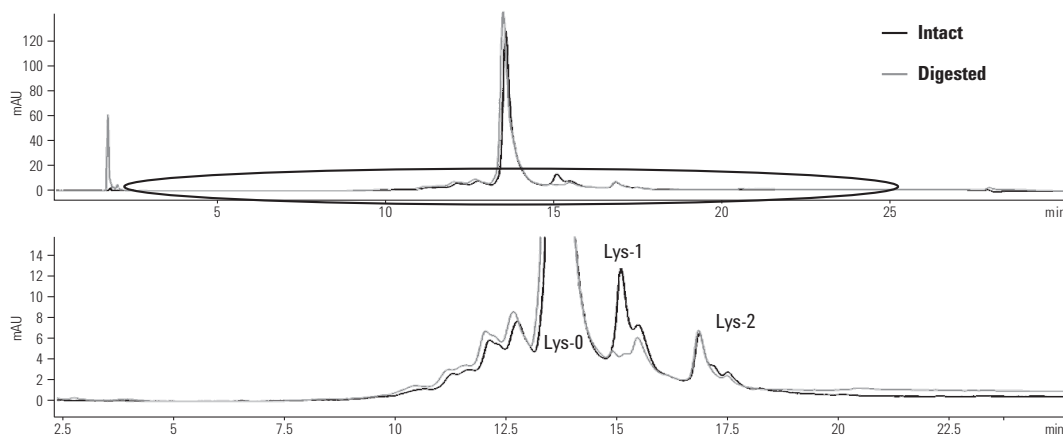

Separation of intact and C-terminal digested IgG1 using an Agilent Bio MAb 5 µm column.

Titer determination of IgG1 from supernatant of CHO-cell

Column: Bio-Monolith Protein A
5069-3639
5.2 x 4.95 mm

Mobile Phase: A: 50 mM phosphate, pH 7.4
B: 100 mM citric acid, pH 2.8

Flow Rate: 1 mL/min

Gradient:

Time (min)	% B
0 to 0.5	0 (binding)
0.6 to 1.7	100 (elution)
1.8 to 3.5	0 (regeneration)

Injection Volume: 50 µL

Detector: UV, 280 nm

Fraction Collection: Time-based

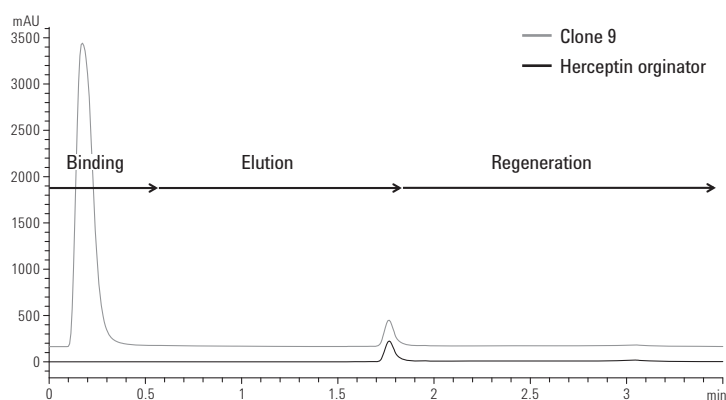

AdvanceBio Bio-Monolith Protein A chromatogram of a trastuzumab-producing CHO clone, clone 9, and of a Herceptin originator diluted in 50 mM Na-phosphate pH 7.4 to 0.2 mg/mL. Note that the supernatant was diluted 1:1 in phosphate buffer.

**Super-fast glycan analysis:
Less than ten minutes with 1.8 µm particles**

Column: AdvanceBio Glycan Mapping
859700-913
2.1 x 150 mm, 1.8 µm

Instrument: Agilent 1290 Infinity LC with 1260 Infinity
Fluorescence Detector (FLD)

Column Temperature: 55 °C

Sample Thermostat: 10 °C

Mobile Phase: A: 100 mM NH₄Formate, pH 4.5
B: ACN

FLD: Excitation = 260
Emission = 430

Injection Volume: 2 µL in 70:30 ACN:100 mM NH₄Formate

Sample: Agilent 2-AB labeled N-linked Human IgG glycan
library (p/n 5190-6996)

Time	%A	%B	Flow Rate (mL/min)
0	25	75	1.0
12	40	60	1.0
12.15	60	40	0.5
12.5	60	40	0.5
12.9	25	75	0.5
13.05	25	75	1.0
15	25	75	1.0

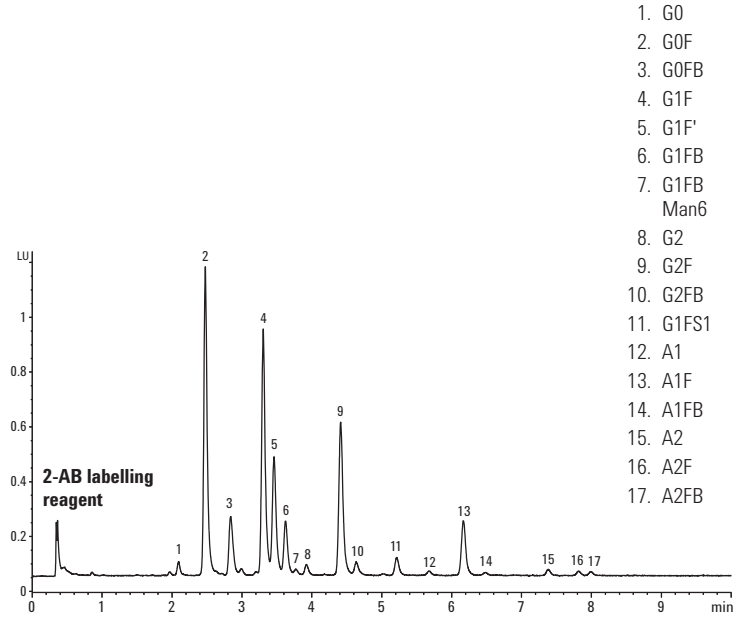

Fast, high resolution glycan mapping (1.8 µm column). This standard is used to test all Agilent AdvanceBio Glycan Mapping columns.

Peak	Glycan	Structure	Peak	Glycan	Structure
1	G0		10	G2FB	
2	G0F		11	G1FS1	
3	G0FB		12	A1	
4	G1F		13	A1F	
5	G1F'		14	A1FB	
6	G1FB		15	A2	
7	G1FB Man6		16	A2F	
8	G2		17	A2FB	
9	G2F				

Peptide Separations

Peptide Mapping

Peptide mapping is required for the characterization of proteins. It is used to confirm the identity of a protein and to identify and quantify post-translational modifications.

The purified protein is first digested using an enzyme, such as trypsin, yielding a range of peptide fragments. The specificity of the enzyme cleavage produces a fingerprint of peptides which is characteristic of that protein. Identification of the peptide fragments confirms the identity of the protein, and changes in the profile of the peptide digest can be used to identify post-translational modifications to that protein that may have occurred during the manufacturing or purification processes.

Reversed-phase UHPLC/HPLC is the preferred technique for the analysis of peptide digests with either MS or UV detection. LC/MS is used for the identification of the peptide fragments and determination of sequence coverage whereas LC/UV is more commonly used for peptide map comparisons in the monitoring/QC segments. To achieve sufficient resolution for quantitation and identification, use specially designed columns for this application such as AdvanceBio Peptide Mapping, 2.7 μm .

Peptide digests are complex mixtures, and for complete coverage, i.e. resolution of the individual peptides, a high efficiency/high resolution column is required. Agilent AdvanceBio Peptide Mapping columns are designed to provide high resolution peptide maps for protein identification and determination of post-translation modifications. These columns let you quickly resolve and identify amino acid substitutions/modifications in a protein primary sequence.

Quality assurance testing with Agilent peptide mix

Column: AdvanceBio Peptide Mapping
653750-902
2.1 x 150 mm, 2.7 μm

Flow Rate: 0.5 mL/min

Injection: 3 μL

Gradient: A, water (0.1% TFA), B, ACN (0.1% TFA), 0-25 min, 15-65% B; 25-26 min, 65-95% B

Temperature: 55 $^{\circ}\text{C}$

Detector: 220 nm

Sample: Agilent Peptide Mapping Standards Mix
(0.5-1.0 $\mu\text{g}/\mu\text{L}$ per peptide) p/n 5190-0583

1. Bradykin frag (1-7)
2. Bradykin acetate
3. Angiotensin II
4. Neurotensin
5. Angiotensin I
6. Renin
7. [Ace-F-3,-2 H-1] Angiotensin (1-14)
8. Ser/Thr Protein phosphatase (15-31)
9. [F14] Ser/Thr Protein phosphatase (15-31)
10. Mellitin (Honey bee venom)

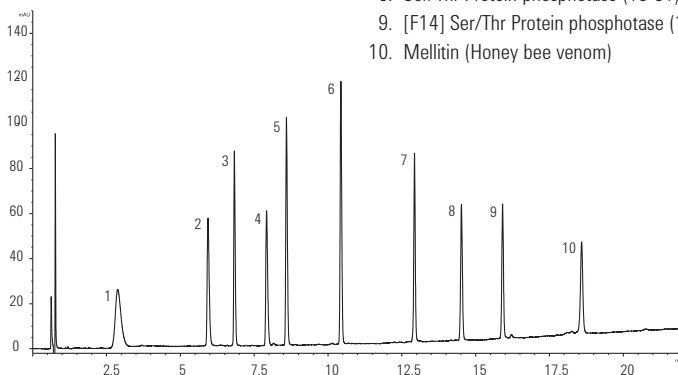

Test mix used for every batch of AdvanceBio Peptide Mapping media. The mixture contains 10 hydrophilic, hydrophobic, and basic peptides, ranging in molecular weight from 757 to 2845 Da. Every column is also tested with a small-molecule probe to ensure efficiency.

Agilent AdvanceBio columns: For faster, more consistent biopharmaceutical analysis

AdvanceBio Peptide Mapping columns are part of Agilent's growing state-of-the-art family of biocolumns. They are designed to deliver consistent, exceptional performance for the separation and characterization of peptides and proteins, antibodies, conjugates, new biological entities, and biopharmaceuticals. The science behind AdvanceBio columns helps to advance accuracy and productivity that support faster analysis and efficiency in your lab.

For ordering information on the Agilent Peptide Mapping solution, turn to page 56.



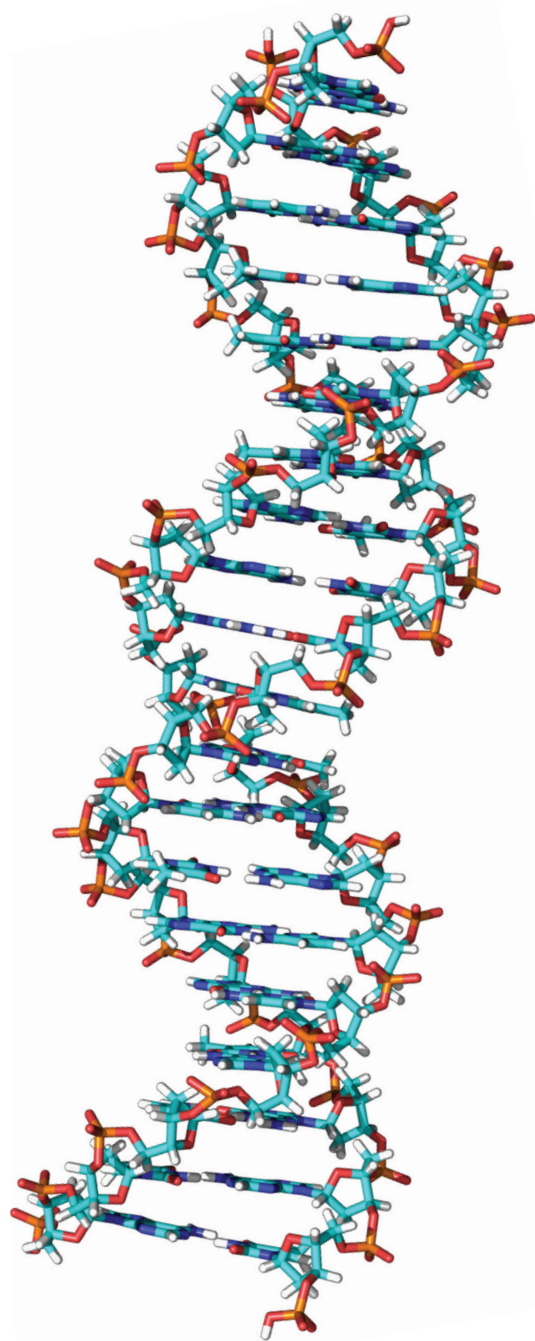

DNA and RNA Oligonucleotide Separations

There is a renewed interest in oligonucleotides (oligos) as they are used in more and more applications, including potential therapeutics. The synthesis workflow is similar to that used for the more established synthetic peptide production, i.e. an activated solid phase synthesis resin is used with sequential addition of specific nucleotides to build the desired sequence.

The nucleotide building blocks are protected at the 5' hydroxyl end with a dimethoxytrityl (DMT) group and the cleaved target oligo will have this protected group still attached. As DMT is hydrophobic, it is a useful handle that can be used for the first stage. To increase the stability of the oligonucleotide, particularly to enzyme degradation, it may be chemically modified, for example by replacing oxygen with sulfur to produce phosphorothioates.

When using chemical synthesis to produce biomolecules, the coupling efficiency of each additional cycle is never 100%. The sample, after cleavage from the solid phase synthesis support, will contain deletion sequences, oligos where one or more residues are missing, and some amount of larger oligos produced by double coupling or branching. The sample mixture is complex and high efficiency techniques are required for its analysis.

There are three UHPLC/HPLC techniques that are routinely used for oligonucleotide separations:

Triyl-on: This procedure is relatively simple to perform and separates the full-length target oligo, which still has the DMT group attached, from the deprotected failure sequences. The analytical information obtained is limited and this is generally considered to be a purification method.

Ion-exchange separations of the triyl-off, deprotected oligos: This method uses the negative charge on the backbone of the oligo to facilitate the separation. Resolution is good for the shorter oligos but decreases with increasing chain length. Aqueous eluents are used but oligos are highly charged, and high concentrations of salt are needed to achieve elution from the column.

Ion-pair reversed-phase separation of the triyl-off, deprotected oligos: This technique uses organic solvents and volatile ion-pairing agents and is suitable for LC/MS. The technique is best performed with high efficiency particles. Conditions that fully denature the oligos and prevent association with complementary sequences are required. Thus, the separation is best performed at elevated temperatures.

TIPS & TOOLS

Want to know how scientists are using Agilent's products for separation of RNA/DNA oligonucleotides? Refer to *"Denaturing reversed phase liquid chromatographic separation of non-coding ribonucleic acids on macro-porous polystyrene-divinylbenzene resins"* *Journal of Chromatography A*, 1312 (2013): 87-92.

Refer to the appendix for more such citations.

DNA and RNA Oligonucleotide Column Selection

Application	Technique	Agilent Columns	Notes
Trityl-on/trityl-off oligonucleotides	Trityl-on	PLRP-S 50 μm media	Separates due to differences in hydrophobicity. Ideal for the separation of trityl-on from trityl-off oligos and is also used for ion-pair reversed-phase separations of deprotected oligos.
Deprotected oligonucleotides	Ion-pair reversed-phase separation of the trityl-off, deprotected oligos	PLRP-S 3 μm to 50 μm	
Deprotected oligonucleotides	Ion-exchange separations of the trityl-off, deprotected oligos	PL-SAX 1000 \AA	Separates deprotected oligos under denaturing high pH conditions. The quaternary amine functionality on the polymeric particles enables ion-exchange separations at high pH, improving chromatography for self-complementary sequences.



TIPS & TOOLS

Further information can be found in:

Agilent PLRP-S 100 \AA HPLC Columns and Media (publication 5990-8187EN)

Agilent PL-SAX 1000 \AA HPLC Columns and Media (publication 5990-8200EN)

www.agilent.com/chem/library

Amino Acid Analysis

The Agilent ZORBAX Eclipse AAA high efficiency column separates amino acids following an updated and improved protocol. During the production of proteins the cell culture medium is monitored to ensure that the correct nutrient balance and levels are maintained for the expression of the product protein. Amino acids are critical components of the feedstock and so must be monitored and adjusted during the production process. Reversed-phase chromatography is the primary technique used for amino acid analysis. Total analysis from injection to injection can be achieved in 14 min (9 min analysis time) on shorter, 75 mm columns and 24 min (18 min analysis time) on the 150 mm column. Sensitivity (5 to 50 pmol with diode array or fluorescence detectors) and reliability are achieved using both OPA- and FMOC-derivatization chemistries in one fully automated procedure using the Agilent 1100/1200 Infinity Series.

ZORBAX Eclipse AAA Column Selection

Application	Diameter x Length (mm)	Particle Size (µm)
Analytical routine sensitivity	4.6 x 150	5.0
Analytical routine sensitivity, high resolution using FLD	4.6 x 150	3.5
Analytical routine sensitivity, high throughput	4.6 x 75	3.5
Solvent Saver high sensitivity, high resolution	3.0 x 150	3.5

Amino Acids

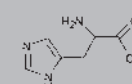
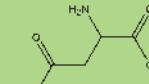
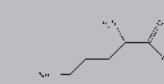
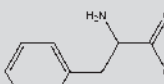
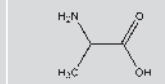
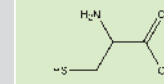
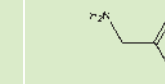
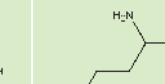
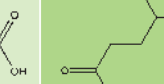
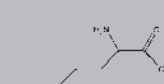
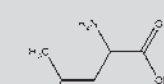
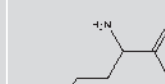
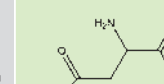
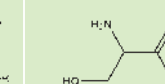
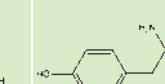
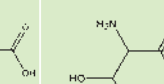
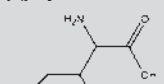
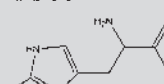
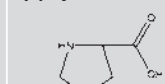
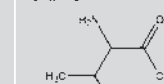
<p>H 155.16 137.14 $C_6H_9N_3O_2$</p> <p>His</p>  <p>Histidine</p>						<p>D 133.10 115.09 $C_4H_7NO_4$</p> <p>Asp</p>  <p>Aspartic Acid</p>
<p>R 174.20 156.19 $C_6H_{14}N_4O_2$</p> <p>Arg</p>  <p>Arginine</p>	<p>F 165.19 147.18 $C_9H_{11}NO_2$</p> <p>Phe</p>  <p>Phenylalanine</p>	<p>A 89.09 71.08 $C_3H_7NO_2$</p> <p>Ala</p>  <p>Alanine</p>	<p>C 121.16 103.14 $C_3H_7NO_2S$</p> <p>Cys</p>  <p>Cysteine</p>	<p>G 75.07 57.05 $C_2H_5NO_2$</p> <p>Gly</p>  <p>Glycine</p>	<p>Q 146.15 128.13 $C_6H_{10}N_2O_3$</p> <p>Gln</p>  <p>Glutamine</p>	<p>E 147.13 129.11 $C_6H_9NO_4$</p> <p>Glu</p>  <p>Glutamic Acid</p>
<p>K 146.19 128.17 $C_6H_{14}N_2O_2$</p> <p>Lys</p>  <p>Lysine</p>	<p>L 131.17 113.16 $C_6H_{13}NO_2$</p> <p>Leu</p>  <p>Leucine</p>	<p>M 149.21 131.20 $C_5H_{11}NO_2S$</p> <p>Met</p>  <p>Methionine</p>	<p>N 132.12 114.10 $C_4H_8N_2O_3$</p> <p>Asn</p>  <p>Asparagine</p>	<p>S 105.09 87.08 $C_3H_7NO_3$</p> <p>Ser</p>  <p>Serine</p>	<p>Y 181.19 163.17 $C_9H_9NO_3$</p> <p>Tyr</p>  <p>Tyrosine</p>	<p>T 119.12 101.10 $C_4H_9NO_3$</p> <p>Thr</p>  <p>Threonine</p>
<p>I 131.18 113.16 $C_6H_{13}NO_2$</p> <p>Ile</p>  <p>Isoleucine</p>	<p>W 204.23 186.21 $C_{11}H_{12}N_2O_2$</p> <p>Trp</p>  <p>Tryptophan</p>	<p>P 115.13 97.12 $C_5H_9NO_2$</p> <p>Pro</p>  <p>Proline</p>	<p>V 117.15 99.13 $C_6H_{11}NO_2$</p> <p>Val</p>  <p>Valine</p>			

- Basic
- Nonpolar (hydrophobic)
- Polar, uncharged
- Acidic

1-Letter amino acid code — **S**

Molecular weight — 105.09

MW-H₂O — 87.08

Molecular formula — $C_3H_7NO_3$

3-Letter amino acid code — **Ser**

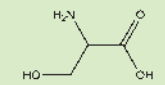
Chemical structure — 

Chemical name — **Serine**

METHOD DEVELOPMENT

Primary Structure Analysis Methods

This section on column selection strategy for primary structure analysis provides some critical details on method development for mAb, proteins, and peptides.

Peptides & Polypeptides MW <10 kDa	Proteins MW >10 kDa	Monoclonal Antibodies Reduced/Fragmented MW <50 kDa	Intact MW >150 kDa
--	-------------------------------	---	------------------------------

Initial Bonded Phase

AdvanceBio Peptide Mapping Also consider: ZORBAX 300Å StableBond C18	ZORBAX 300Å StableBond C8 Also consider: ZORBAX 300Å StableBond C18 ZORBAX 300Å StableBond C3 Poroshell 300 StableBond C18 Poroshell 300 StableBond C8 Poroshell 300 StableBond C3	AdvanceBio RP-mAb StableBond C8 Also consider: AdvanceBio RP-mAb C4 AdvanceBio RP-mAb Diphenyl ZORBAX 300Å Diphenyl ZORBAX 300Å StableBond C8 ZORBAX 300Å StableBond C3 ZORBAX 300Å StableBond C18	AdvanceBio RP-mAb C4 Also consider: AdvanceBio RP-mAb StableBond C8 AdvanceBio RP-mAb Diphenyl Poroshell 300 StableBond C3 Poroshell 300 StableBond C8
---	---	--	--

Initial Separation Conditions

Mobile Phase: A: 95% H ₂ O:5% ACN with 0.1% TFA B: 5% H ₂ O:95% ACN with 0.085% TFA Gradient: 3-60% in 30 min Temperature: 40 °C		Mobile Phase: A: 95% H ₂ O:5% ACN with 0.1% TFA B: 5% H ₂ O:95% ACN with 0.085% TFA Gradient: 5-70% in 20 min Temperature: 80 °C		Mobile Phase: A: 100% H ₂ O with 0.1% TFA B: 10% H ₂ O:10% ACN:80% n-PA with 0.08% TFA Gradient: 5-40% in 10 min Temperature: 60 °C		Mobile Phase: A: 98% H ₂ O:2% IPA with 0.1% TFA B: 10% H ₂ O:0% ACN:70% IPA with 0.08% TFA Gradient: 10-60% B in 5 min Temperature: 80 °C	
2.1 mm id Columns	4.6 mm id Columns	2.1 mm id Columns	4.6 mm id Columns	2.1 mm id Columns	4.6 mm id Columns	2.1 mm id Columns	4.6 mm id Columns
Particle Size 2.7 µm SPP	Particle Size 2.7 µm SPP	Particle Size 1.8 µm TPP 3.5 µm TPP 5 µm TPP 5 µm SPP	Particle Size 3.5 µm TPP 5 µm TPP	Particle Size 3.5 µm SPP 1.8 µm TPP 3.5 µm TPP 5 µm TPP	Particle Size 3.5 µm SPP 3.5 µm TPP 5 µm TPP	Particle Size 3.5 µm SPP 5 µm SPP	Particle Size 3.5 µm SPP
Flow Rate 0.5 mL/min	Flow Rate 2.0 mL/min	Flow Rate 0.5 mL/min 0.2 mL/min 0.2 mL/min 1.0 mL/min	Flow Rate 1.0 mL/min 1.0 mL/min	Flow Rate 0.8 mL/min 0.3 mL/min 0.2 mL/min 0.2 mL/min	Flow Rate 4.0 mL/min 1.0 mL/min 1.0 mL/min	Flow Rate 1.0 mL/min	Flow Rate 5.0 mL/min

SPP = superficially porous particle, TPP = totally porous particle

Start at Low pH with Simple Aqueous/Organic Gradient

Typically, a water:acetonitrile with 0.1% trifluoroacetic acid (TFA) gradient is used to elute all components of interest. A typical high resolution gradient on a 300Å pore size column requires 30-50 min. An AdvanceBio RP-mAb column requires a shorter analysis time and a higher flow rate and still provides exceptional resolution. To improve resolution, increase the gradient time, decrease column length, or increase flow rate. For LC/MS methods, TFA can reduce detector sensitivity and is often replaced with ammonium formate/formic acid.



Optimize Sample Solubility

For best peak shape and recovery at any pH, it is important to completely solubilize a sample. Highly acidic or neutral solvents can be used with AdvanceBio RP-mAb, ZORBAX 300Å StableBond, Poroshell 300 StableBond, and AdvanceBio Peptide Mapping, while neutral solvents and dilute bases can be used with ZORBAX 300Extend-C18 and Poroshell 300Extend-C18.

Solvent Choices to Solubilize Proteins and Peptides

Water/phosphate buffer
 Dilute acid (TFA, acetic acid or HCl)
 Neutral pH, 6-8 M guanidine-HCl or isothiocyanate
 Acetic acid 5%/6 M urea
 Dilute acid + aqueous/organic solvents (ACE, MeOH, THF)
 Dilute base (ammonium hydroxide)
 DMSO or 0.1%-1% in DMSO
 Formamide

Weakest



Strongest



Increase the Temperature

Separations of proteins and peptides are influenced by temperature and higher column temperature can dramatically improve both resolution and recovery of proteins and hydrophobic and aggregating peptides.

AdvanceBio RP-mAb: up to 90 °C
ZORBAX 300 StableBond, Poroshell 300 StableBond: up to 80 °C
AdvanceBio Peptide Mapping: up to 60 °C



Optimize Mobile Phase pH

Try mid and high pH if low pH does not work

If an optimized, low pH method does not provide an ideal separation, then mid or high pH mobile phase can be used. At high pH, selectivity is often very different because acidic amino acids become negatively charged and some basic amino acids may lose their charge. ZORBAX 300Extend-C18 is an excellent choice for mid to high pH separation.

Column: ZORBAX 300Extend-C18
 4.6 x 150 mm, 5 µm
 773995-902

Gradient: 5-60% B in 30 min

Temperature: 25-30 °C (<60 °C)

Mobile Phase: A: 20 mM NH₄OH in H₂O
 B: 20 mM NH₄OH in 80% ACN

Flow Rate: 1 mL/min

Reversed-Phase LC/MS Methods

LC/MS of proteins and peptides is used to provide information for protein characterization, to accurately identify post-translational modifications of proteins, and to determine the molecular weight of synthetic and natural peptides. LC/MS is also used to provide protein identification in 2D separations for proteomics applications. Therefore, LC/MS of proteins and peptides is a critical separation area, which requires some special column and mobile phase recommendations. In general, smaller column sizes are used for LC/MS and TFA is generally not used in mobile phase because of reduced sensitivity in the MS with this mobile phase additive.

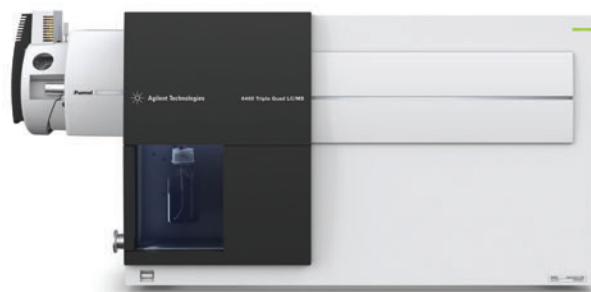

Analytical LC/MS Applications – 2.1 mm id columns provide good sensitivity when sample size is not limited. With Poroshell columns, smaller 1 mm column ids are used.



High Sensitivity/Proteomics Applications

Capillary columns are used for high sensitivity protein and peptide applications. The 0.5 mm id columns are used for protein and protein digest separations while the 0.3 mm id columns are most often used for protein digests. These can be analyzed at high pH with an ammonium hydroxide mobile phase. Nano columns (0.1 and 0.075 mm id) are often used in 2D LC/MS systems for proteomics and the initial choice is C18 bonded phase.

Charge Variant Analysis Methods

This section on column selection strategy for charge variant analysis provides some critical details on method development for mAb, proteins, and peptides.

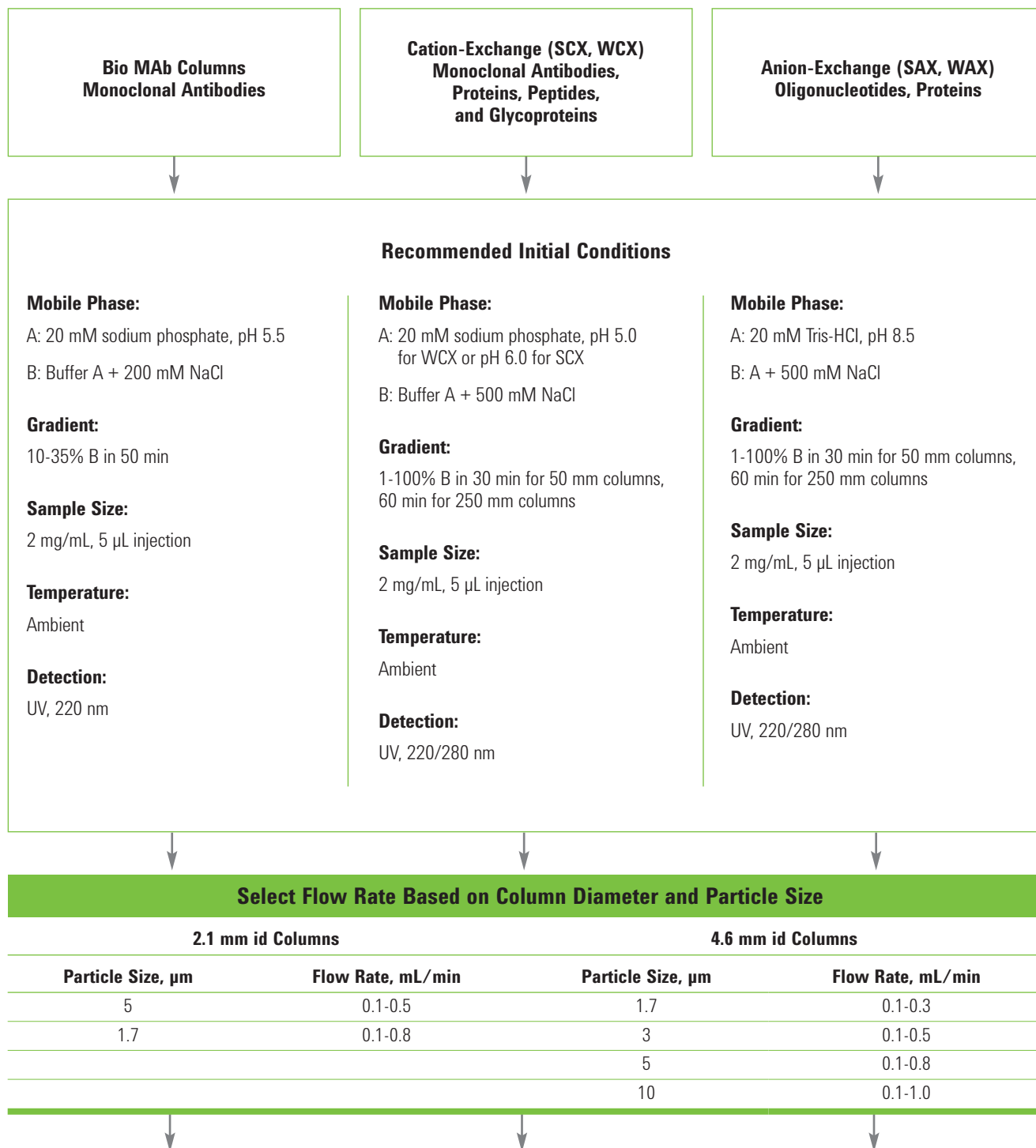

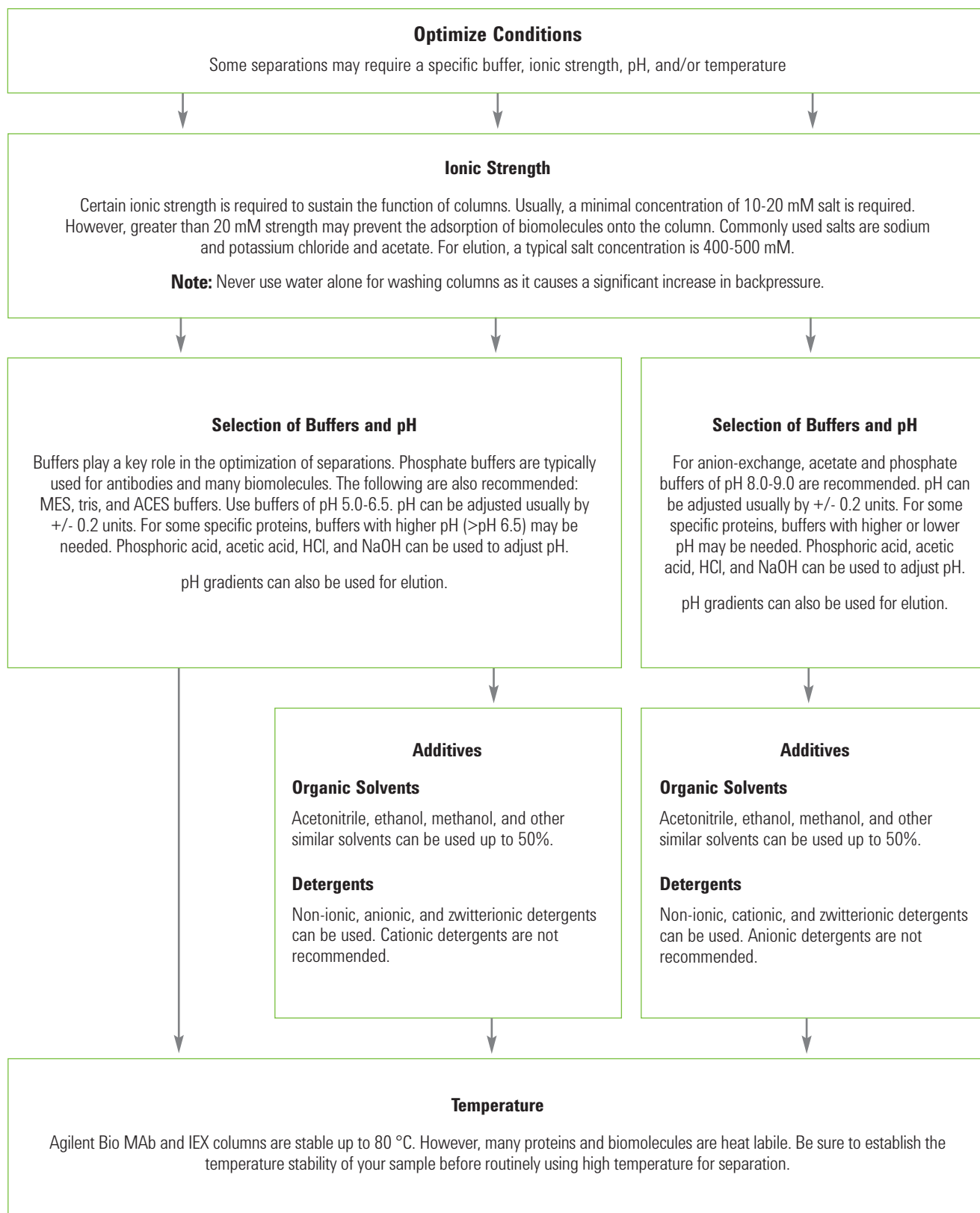

Charge Variant Analysis Methods with Agilent Buffer Advisor

On quaternary mixing to create a salt gradient with constant pH

On quaternary mixing to create a pH gradient with salt gradient for cleanup

Recommended Initial Conditions

Salt Gradient (see application note: 5990-9628EN)

Columns:	Agilent Bio WCX, 4.6 x 250 mm, 10 µm Agilent Bio WCX, 4.6 x 250 mm, 5 µm
Mobile Phase:	A: water B: 1.6 M NaCl C: 40.0 mM NaH ₂ PO ₄ D: 40.0 mM Na ₂ HPO ₄ By combining predetermined proportions of C and D, 20 mM buffer solutions at the desired pH range are produced.
Gradient:	0 to 50% B, 0 to 20 min (constant pH, for example, pH 6.0) 50% B, 20 to 25 min 0% B, 25 to 35 min
Temperature:	Ambient
Injection Volume:	10 µL
Sample:	Ovalbumin, ribonuclease A, cytochrome c, lysozyme
Sample Conc:	2 mg/mL (in 20 mM sodium phosphate buffer, pH 6.0)
Detection:	UV, 220 nm
Instrument:	Agilent 1260 Infinity Bio-inert Quaternary LC

pH Gradient (see application note: 5990-9629EN)

Column:	Agilent Bio MAb, 4.6 x 250 mm, 5 µm
Mobile Phase:	A: water B: 1.6 M NaCl C: 40.0 mM NaH ₂ PO ₄ D: 40.0 mM Na ₂ HPO ₄ By combining predetermined proportions of C and D, buffer solutions at the desired pH range are produced at the selected buffer strengths.
Gradient:	pH 6.0 to 8.0, 0 to 20 min 0 to 800 mM NaCl, 20 to 25 min 800 mM NaCl, 25 to 30 min
Temperature:	Ambient
Injection Volume:	10 µL
Sample:	IgG monoclonal antibody
Sample Conc:	2 mg/mL (in 20 mM sodium phosphate buffer, pH 6.0)
Detection:	UV, 220 nm
Instrument:	Agilent 1260 Infinity Bio-inert Quaternary LC

Note: Similarly, the above approaches can be applied for Agilent WAX and SCX columns with modifications

Select Flow Rate Based on Column Diameter and Particle Size

2.1 mm id Columns		4.6 mm id Columns	
Particle size, µm	Flow rate, mL/min	Particle size, µm	Flow rate, mL/min
1.7	0.1-0.3	1.7	0.1-0.3
3	0.1-0.5	3	0.1-0.5
5	0.1-0.8	5	0.1-0.8
10	0.1-1.0	10	0.1-1.0

Note: Always start with a low flow rate and default to the recommended operating limit of the column.

Aggregation and Fragment Analysis Methods

This section on column selection strategy for aggregation analysis provides some critical details on method development for mAb, proteins, and peptides.

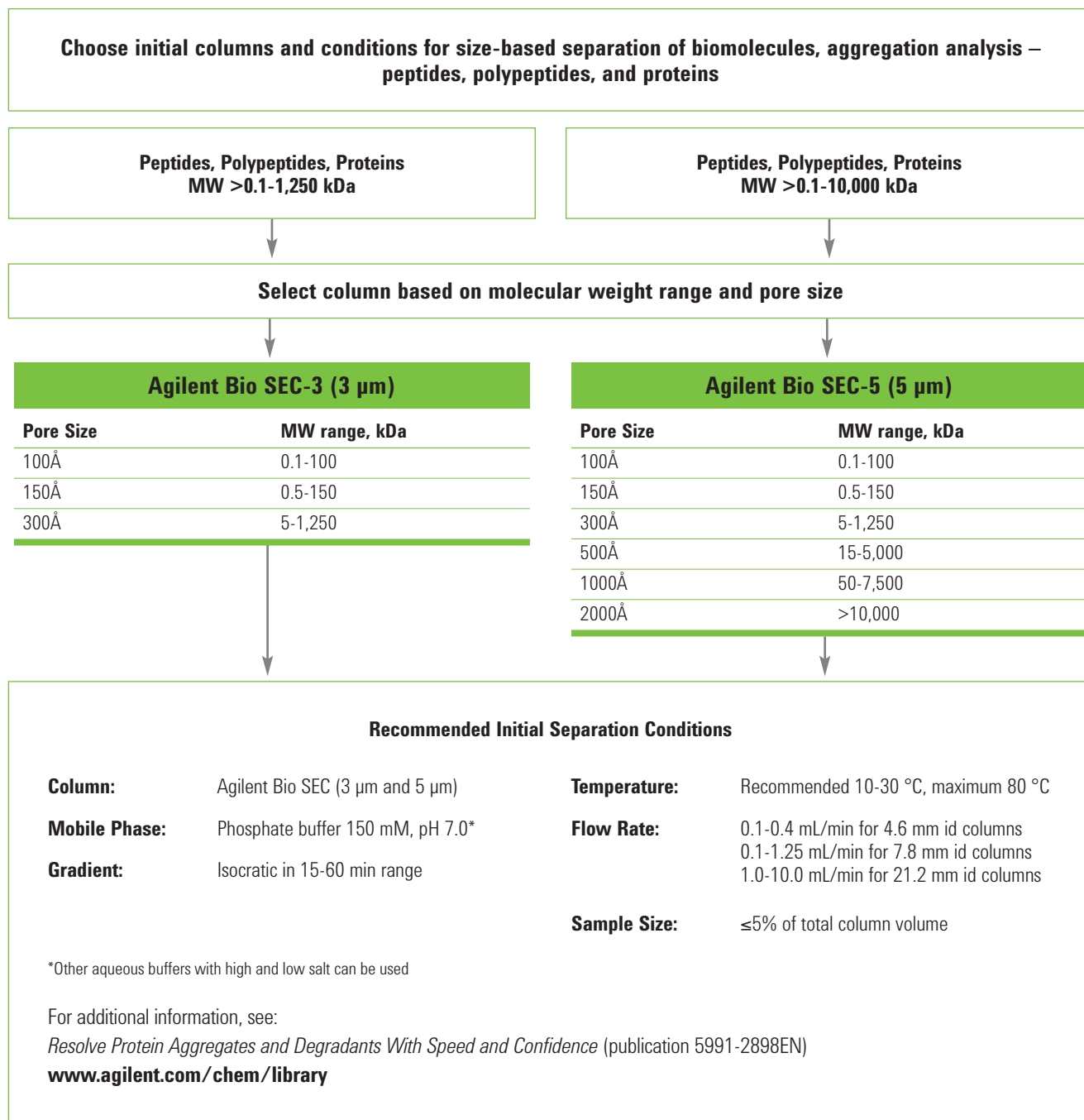

After the initial chromatogram, additional changes may be needed to improve the separation, maintain protein solubility, or to decrease sample interaction with the chromatographic media. The ionic strength of the mobile phase can be adjusted up or down to attain an optimized separation. pH can also be adjusted usually +/- 0.2 units. If further optimization is necessary, the upward or downward range should be expanded. A change of temperature or addition of an organic solvent can also be used.



For protocols requiring additional salt, these buffers are typical:

100-150 mM sodium chloride in 50 mM sodium phosphate, pH 7.0

100-150 mM sodium sulfate in 50 mM sodium phosphate, pH 7.0

50-100 mM urea in 50 mM sodium phosphate, pH 7.0

Other similar salts (e.g. KCl) and guanidine hydrochloride can also be used.

pH range:

2.0-8.5

Potential organic solvent additions include:

5-10% ethanol (or other similar solvents) in 50 mM sodium phosphate, pH 7.0

5% DMSO in 50 mM sodium phosphate, pH 7.0

Particular care must be taken to avoid excessive pressure changes due to the high viscosity of some aqueous/organic solvent mixtures. Use reduced flow rate or increased temperature to help alleviate potential problems.

Temperature:

Typically, SEC separations are run at 20-30 °C. Separation of proteins and peptides may require higher temperature to improve both resolution and recovery of proteins and hydrophobic peptides.

Maximum temperature of Bio SEC columns is 80 °C.

Glycan and Hydrophilic/Glycopeptide Analysis

Glycans
MW <5 kDa

Glycopeptides & Hydrophilic Peptides
MW <10 kDa

Initial Bonded Phase

AdvanceBio Glycan Mapping, 1.8 μ m

For fast separations
and high throughput analysis

AdvanceBio Glycan Mapping, 2.7 μ m

For high resolution and 250 mm
column lengths
Superficially porous for separation
efficiency at lower pressure

ZORBAX RRHD 300-HILIC

Also consider:
AdvanceBio Glycan Mapping columns

Initial Separation Conditions

Mobile Phase:

A: ACN
B: 100 mM ammonium formate, pH 4.5

Gradient:

25-40% A in 12 min

Temperature:

55 °C

Mobile Phase:

A: ACN
B: 100 mM ammonium formate, pH 4.5

Gradient:

25-60% A in 35 min

Temperature:

60 °C

Mobile Phase:

A: ACN
B: 50 mM ammonium formate, pH 4.5

Gradient:

95-0% A in 15 min

Temperature:

Ambient

Columns

Dimensions

2.1 x 100 mm
2.1 x 150 mm

Application

High throughput
Speed with resolution

Columns

Dimensions

2.1 x 100 mm
2.1 x 150 mm
2.1 x 250 mm
4.6 x 100 mm
4.6 x 150 mm
4.6 x 250 mm

Application

UHPLC speed
Robust methods
UHPLC resolution
HPLC speed
Robust methods
HPLC resolution

Columns

Dimensions

2.1 x 50 mm
2.1 x 100 mm

Application

Speed
Resolution

Titer Determination & Cell Culture Optimization Methods

Agilent Bio-Monolith Protein A Method

Recommended Condition

Column:	Agilent Bio-Monolith Protein A (p/n 5069-3639)			
Mobile Phase:	A: 50 mM phosphate, pH 7.4; B: 100 mM citric acid, pH 2.8 mM, or 500 mM acetic acid, pH 2.6			
Gradient:	Time (min)	%A	%B	
	0-0.5	100	0	Binding
	0.6-1.7	0	100	Eluting
	1.8-3.5	100	0	Re-equilibrating
Flow Rate:	1 mL/min			
Sample:	IgG1 (1-20 mg/mL) and CHO cell supernatant contains IgG1 (up to 20 mg/mL total protein)			
Injection Volume:	Variable (50 µL, optimized for CHO cell culture supernatant contains IgG1)			
Temperature:	Ambient			
Detection:	UV, 280 nm			

Note: Additional salts such as sodium chloride can be added to mobile phases, up to 150 mM. Higher salts should be determined experimentally.



TIPS & TOOLS

Agilent recognizes that there are many different factors that affect the quality of mAb and protein separations. To enable you to gain the best results, we have developed a series of 'how to' guides. For more information, refer to:

Keys for enabling optimum peptide characterizations: A peptide mapping "How to" guide (publication 5991-2348EN)

Ion-exchange chromatography for biomolecule analysis: A "How to" guide (publication 5991-3775EN)

Size exclusion chromatography for biomolecule analysis: A "How to" guide (publication 5991-3651EN)

For more on the above, and other guides that will help in your characterization, go to:

www.agilent.com/chem/getbioguides

High Sensitivity Capillary Column Methods

Mobile Phase Considerations for Reversed-Phase Methods

For LC/MS methods where the column eluent passes directly from the column to the MS detector the mobile phases must contain only volatile salts, and additives. And for maximum sensitivity there must be no suppression of the ionization or adjunct formation.

Low pH

TFA is generally not used for LC/MS separations of proteins and peptides as it suppresses ionization and increases the limit of detection. The first step is normally to replace TFA with 0.1 to 1% formic acid. Acetic acid up to 1% can also be used as an alternative mobile phase modifier. At low pH, the best separation may still be obtained with TFA in the mobile phase but with a reduction in sensitivity. In some cases, the TFA can be displaced postcolumn with an alternative acid, such as propionic acid by the use of a simple online desalting/counter ion-exchange.

Mid and High pH

High pH is less often used for protein characterization but LC/MS can also be done at high pH with 10-20 mM NH_4OH as a mobile phase additive.

AGILENT INSTRUMENTS FOR PROTEIN IDENTIFICATION AND IMPURITY PROFILING



Agilent 1260 Infinity Bio-inert Quaternary LC: Your best choice for protein separations

The only UHPLC that provides a metal-free sample flow path. Other advantages include:

- ▶ **100% Bio-inertness**
 - No stainless steel: sample does not touch metal surfaces
 - pH 1 to pH 13 (pH 14 short-term)
 - Handles 2 M salt and 8 M urea
 - New capillary technology
- ▶ **UHPLC capability:** 600 bar
- ▶ **Robust and easy to use** with low surface activity, corrosion resistance, active seal wash, and quaternary buffer mixing

Ideal for protein identification

For best results, use with AdvanceBio Peptide Mapping columns, Bio SEC-3 and Bio IEX 1.7 μm



Agilent 1290 Infinity Binary LC: Our most adaptable UHPLC system with the widest application range

Best-in-class resolution per time, dispersion, sensitivity, accuracy, and precision in LC/UV and LC/MS. Combines innovative active damping, microfluidic mixing, and optofluidic waveguides detection technology to achieve:

- ▶ UHPLC power range with up to 1200 bar and 5 mL/min
- ▶ The fastest and easiest method transfer using ISET, Agilent's unique Intelligent System Emulation Technology
- ▶ UHPLC productivity with HPLC ownership costs

Use for impurity profiling, peptide mapping or ultra-fast gradients

For best results, use with ZORBAX RRHD 300Å 1.8 μm columns



Agilent 1260 Infinity Binary LC:
Raising the standard in analytical HPLC
with 600 bar, high speed 80 Hz detector,
and up to 10x higher sensitivity

100% HPLC compatibility, UHPLC capability, plus:

- ▶ UHPLC performance with HPLC ownership costs
- ▶ Supports LC and LC/MS applications, with any narrow and standard bore analytical column (2.1 to 4.6 mm id)
- ▶ Superior gradient accuracy by high-pressure mixing

Use for any standard UHPLC application



Agilent 1290 Infinity Quaternary LC:
Combining performance with flexibility

The only quaternary UHPLC system with binary-like accuracy and precision. Other advantages include:

- ▶ UHPLC power range with up to 1200 bar and 5 mL/min
- ▶ BlendAssist, the easiest tool for accurate buffer and additive blending
- ▶ UHPLC productivity with HPLC ownership costs

Use for method development or walk-up systems
with accurate buffer blending

For a closer look at these advanced systems, visit
agilent.com/chem/BioHPLC

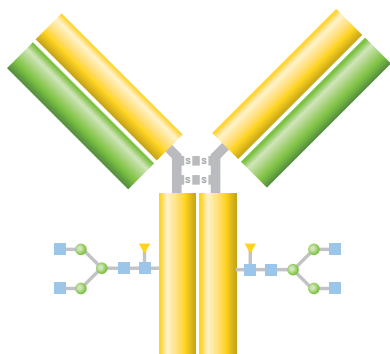

PRIMARY STRUCTURE ANALYSIS





Accurately determine amino acid sequence and post-translational modifications

For full characterization of a protein, such as a monoclonal antibody, it is necessary to look at the primary amino acid sequence and any post-translational modifications to the sequence that may have occurred during the purification or formulation steps of manufacture. To perform this type of analysis, denaturing conditions are required, so reversed-phase LC is normally the technique of choice.

Agilent offers the most comprehensive range of wide-pore, 300Å, 450Å, and larger, reversed-phase BioHPLC columns, all backed by technical support experts and application chemists around the globe. The family includes 1.8, 3.5, and 5 µm porous particles for pressures from 400 to 1200 bar, three different superficially porous particles for UHPLC separations at lower pressure, and polymeric columns for analysis under the most extreme conditions.

- **Agilent AdvanceBio RP-mAb columns:** the only reversed-phase columns designed especially for mAb characterizations. 450Å pore size Poroshell technology and the right bonded phase selectivity provide fast, high resolution characterization of intact mAbs and mAb fragments.
- **Agilent ZORBAX RRHD 300Å 1.8 µm columns:** deliver UHPLC performance for reversed-phase separations of intact proteins, protein fragments, and digests with 1200 bar stability.
- **Agilent ZORBAX 300Å 3.5, and 5 µm columns:** fully porous materials for HPLC and prep separations; many of the bonded phases scalable from the 1.8 µm particle.
- **Agilent Poroshell 300 columns:** the industry's first superficially porous small particle columns for fast polypeptide and protein separations.
- **Agilent AdvanceBio Peptide Mapping columns:** quickly resolve and identify amino acid modifications in primary structure. With their 2.7 µm particles, and C18 functionality, AdvanceBio Peptide Mapping columns deliver excellent retention, resolution, and peak shape for basic hydrophobic peptides.
- **Agilent PLRP-S columns:** macroporous polymer particles deliver HPLC separations over the widest pH range. With three wide-pore sizes and eight particle sizes, the PLRP-S columns provide optimum solutions for analytical prep separations of peptides, proteins, and protein complexes.

Reversed-Phase Column Selection

Application	Agilent Columns	Notes	
Monoclonal antibodies and mAb fragments	AdvanceBio RP-mAb • C4 • SB-C8 • Diphenyl	Based on Poroshell technology featuring superficially porous particles that reduce diffusion distances and allow higher flow rates and steeper gradients to be used thus reducing run times – even on 600 bar systems. 450Å pore size provides full access to the bonded phase by large molecules ensuring the best possible chromatography. Robust bonded phases designed for monoclonal antibody separations provide a range of selectivities that allow resolution to be optimized.	
Intact proteins, monoclonal antibodies, mAb fragments and polypeptides	ZORBAX 300Å, 1.8 µm • RRHD 300SB-C18 • RRHD 300SB-C8 • RRHD 300SB-C3 • RRHD 300-Diphenyl	Optimized packing processes achieve stability up to 1,200 bar for use with the Agilent 1290 Infinity LC. RRHD 1.8 µm columns are available in 50, and 100 mm lengths for fast or high resolution – truly high definition – separations of the most complex samples. StableBond C18 is ideal for complex protein and protein digest separations.	
	ZORBAX 300Å, 3.5, and 5 µm • 300SB-C18 • 300SB-C8 • 300SB-C3 • 300SB-CN	Ideal for use with HPLC systems. StableBond C3 and CN are useful for larger, more hydrophobic compounds.	
	ZORBAX 300Å Extend-C18	Incorporate a unique bidentate silane, combined with a double-endcapping process that protects the silica from dissolution at high pH – up to pH 11.5.	
Large intact proteins	Poroshell 300 • 300SB-C18 • 300SB-C8 • 300SB-C3 • 300Extend-C18	5 µm Poroshell particles with 300Å pores enable rapid HPLC separations of intact proteins.	
Proteins in protein digests	AdvanceBio Peptide Mapping	An ideal 120Å pore size for identifying a wide molecular weight range of peptides. Tested with a challenging peptide mix to ensure performance. The unique Agilent Poroshell technology enables shorter run times and better resolution of the full peptide sequence.	
Peptides to DNA	PLRP-S	Particles are inherently hydrophobic and so an alkyl ligand bonded phase is not required for reversed-phase separations. This gives a highly reproducible material that is free from silanols and heavy metal ions.	
Small molecules/synthesis	100Å		
Recombinant peptides/proteins	300Å		
Large proteins	1000Å		
DNA/high speed separation	4000Å		
Amino acids	ZORBAX Eclipse Amino Acid Analysis (AAA)	Tested for amino acid analysis using well-known OPA and FMOc precolumn derivatization chemistry. Options for HPLC and UHPLC.	

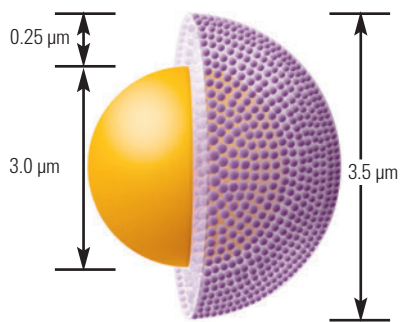

AdvanceBio RP-mAb

- **Improved accuracy:** Superficially porous particles (3.5 μm) with wide pores (450Å) increase mAb resolution while maintaining compatibility with all LC instruments
- **Speed:** Shorter analysis times compared to columns packed with fully porous particles
- **Flexible method development:** Range of chemistries – SB-C8, C4, and Diphenyl
- **Lower costs:** Robust Poroshell packed bed and 2 μm inlet frit extend column lifetime by helping prevent inlet blockage

The only reversed-phase columns focused on the unique challenges of monoclonal antibody characterization

Analysis of intact and reduced monoclonal antibodies are critical measurements for characterizing therapeutic proteins and understanding their efficacy and stability. Poor chromatographic separations can result in rework and even compromise the accuracy of the characterization. Long analysis times negatively impact the throughput of a laboratory and lead to delays in making decisions based on the results of characterization.

To eliminate these problems, Agilent has developed a new reversed-phase column to optimize the performance of intact and reduced mAb analysis. The Agilent AdvanceBio RP-mAb column is based on Poroshell technology with unique engineering for pore size and bonded phases.



TIPS & TOOLS

For more information on the characterization of monoclonal antibody primary structure see:
Better Characterization of Biomolecules using Agilent AdvanceBio Reversed-Phase Columns (publication 5991-2032EN)
www.agilent.com/chem/library

Large biomolecules such as monoclonal antibodies are typically separated slowly to reduce the potential peak broadening of these slow diffusing analytes. However, the Poroshell technology used in AdvanceBio RP-mAb columns features superficially porous particles made with a thin layer of porous silica, 0.25 μm thick, on a 3.0 μm solid silica core. This morphology reduces the diffusion distance thus allowing higher flow rates and steeper gradients to be used – even on 600 bar systems. The wide 450Å diameter of the pores in the thin layer provides full access to the bonded phase by the large monoclonal antibody molecules ensuring the best possible chromatography. The choice of robust bonded phases designed for monoclonal antibody separations, C4, SB-C8, and a unique Diphenyl, provide a range of selectivities that allow resolution to be optimized.

Agilent AdvanceBio RP-mAb columns deliver higher resolution and shorter run times to provide fast, accurate and reproducible results when analyzing monoclonal antibodies for biopharma discovery, development, and QA/QC applications.

Column Specifications

Bonded Phase	Pore Size	Temp Limits*	pH Range*	Endcapped
AdvanceBio RP-mAb C4	450Å	90 °C	1.0-8.0	Yes
AdvanceBio RP-mAb SB-C8	450Å	90 °C	1.0-8.0	No
AdvanceBio RP-mAb Diphenyl	450Å	90 °C	1.0-8.0	Yes

Specifications represent typical values only.

*Columns are designed for optimal use at low pH. At pH 6-8, highest column stability for all silica-based columns is obtained by operating at temperatures <40 °C and using low buffer concentrations in the range of 0.01-0.02 M.

High speed, high resolution separation of Herceptin Variant IgG1

Column: AdvanceBio RP-mAb C4
795775-904
2.1 x 100 mm, 3.5 μ m

Mobile Phase: A: 0.1% TFA in water:IPA (98:2)
B: IPA:ACN:Mobile phase A (70:20:10)

Flow Rate: 1.0 mL/min

Gradient: 10-58% B in 4 min, 1 min wash at 95% B,
1 min re-equilibration at 10% B

Temperature: 80 °C

Detector: UV, 254 nm

Sample: 5 μ L injection of humanized recombinant
Herceptin Variant IgG1 intact from
Creative Biolabs (1 mg/mL)

Characterization in less than 2 minutes

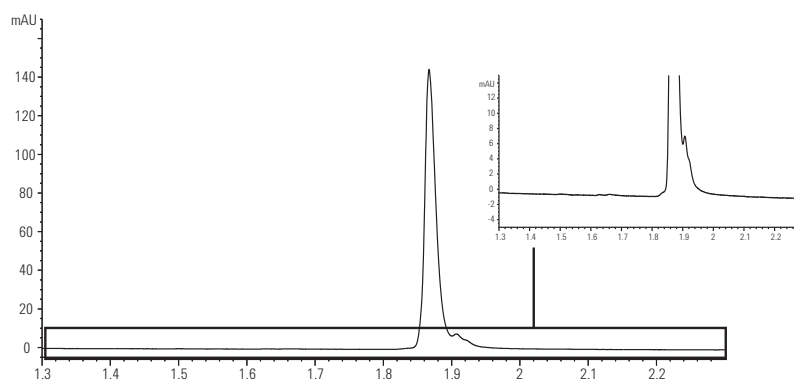

AdvanceBio RP-mAb C4 provides a sharp peak and resolves fine detail in less than 2 minutes.

Separation of intact humanized recombinant Herceptin IgG1

Column: AdvanceBio RP-mAb C4
795775-904
2.1 x 100 mm, 3.5 μ m

Mobile Phase: A: 0.1% FTA in water:IPA (98:2)
B: IPA:ACN:Mobile phase A (70:20:10)

Flow Rate: 1.0 mL/min

Gradient: 10-58% B in 4 min, 1 min wash at 95% B, 1 min re-equilibration at 10% B

Temperature: 80 °C

Detector: UV, 254 nm

Sample: 5 μ L injection of humanized recombinant Herceptin Variant IgG1 intact from Creative Biolabs (1 mg/mL)

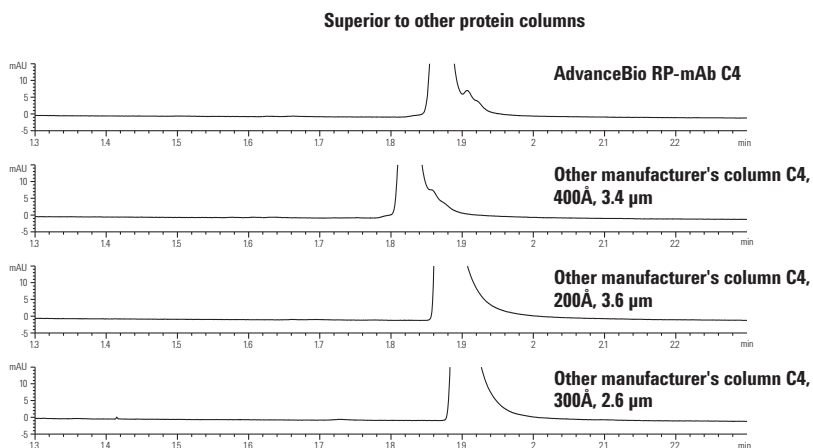

Specifically designed for mAb separations, AdvanceBio RP-mAb provides superior peak shape and resolution than other columns used for intact protein separations.

Selective diphenyl phase

Column: AdvanceBio RP-mAb Diphenyl
795775-944
2.1 x 100 mm, 3.5 μ m

Mobile Phase: A: 0.1% TFA in water: IPA (98:2)
B: IPA:ACN:Mobile phase A (70:20:10)

Flow Rate: 1.0 mL/min

Gradient: 10-58% B in 4 min, 1 min wash at 95% B, 1 min re-equilibration at 10% B

Temperature: 80 °C

Detector: UV, 254 nm

Sample: 5 μ L injection of humanized recombinant Herceptin Variant IgG1 intact from Creative Biolabs (1 mg/mL)

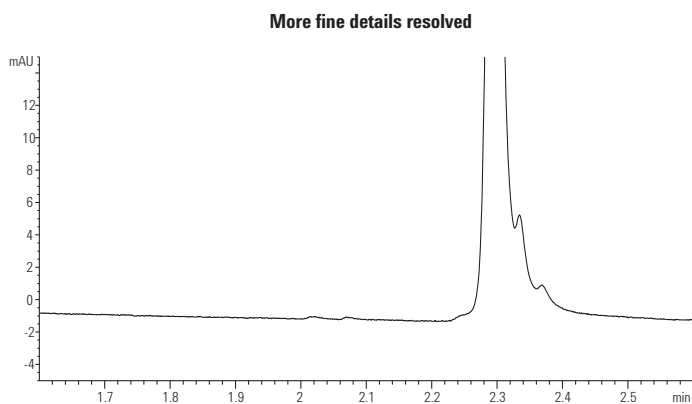

The unique selectivity of AdvanceBio RP-mAb Diphenyl resolves even more fine detail.

The Poroshell advantage

Column: AdvanceBio RP-mAb SB-C8
785775-906
2.1 x 100 mm, 3.5 µm

Mobile Phase: A: 0.1% TFA in water
B: n-Propanol:ACN:Mobile phase A (80:10:10)

Flow Rate: 0.8 mL/min

Gradient: 5-40% B in 5 min, 1 min wash at 95% B,
1 min re-equilibration at 10% B

Temperature: 60 °C

Detector: UV, 220 nm

Sample: 1 µL injection of Fc/Fab, papain-digested humanized
recombinant Herceptin Variant IgG1 from Creative
Biolabs (2 mg/mL)

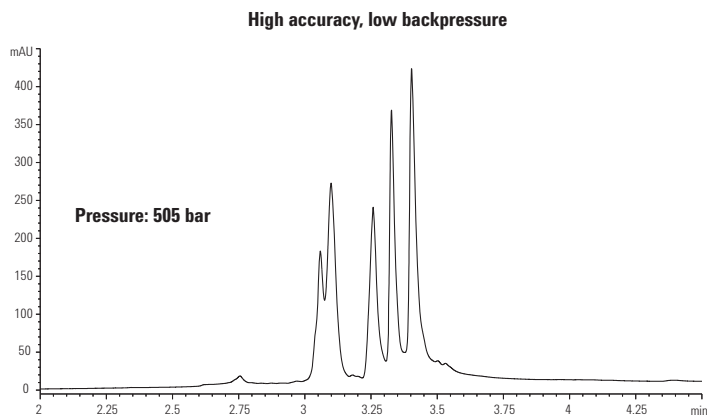

The wide-pore Poroshell technology of the AdvanceBio RP-mAb column delivers high efficiency, a short analysis time, and low pressure, at temperatures below 80 °C – the typical temperature of many reversed-phase methods.

AdvanceBio RP-mAb

Size (mm)	Particle Size (µm)	AdvanceBio RP-mAb C4 USP L26	AdvanceBio RP-mAb SB-C8 USP L7	AdvanceBio RP-mAb Diphenyl USP L11
4.6 x 150	3.5	793975-904	783975-906	793975-944
4.6 x 100	3.5	795975-904	785975-906	795975-944
4.6 x 50	3.5	799975-904	789975-906	799975-944
2.1 x 150	3.5	793775-904	783775-906	793775-944
2.1 x 100	3.5	795775-904	785775-906	795775-944
2.1 x 75	3.5	797775-904	787775-906	797775-944
2.1 x 50	3.5	799775-904	789775-906	799775-944

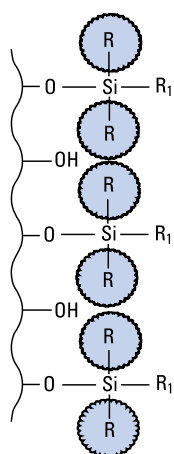

Sterically Protected 300StableBond
Bonded Phase

ZORBAX 300Å StableBond

Agilent ZORBAX 300Å StableBond columns are an ideal choice for the reproducible separations of proteins and peptides for two key reasons. First, wide-pore, 300Å columns are necessary for an efficient separation of proteins and peptides, or other large molecules, to allow these analytes to completely access the bonded phase. Second, 300StableBond columns are unmatched in their durability at low pH, such as with TFA-containing mobile phases typically used for protein and peptide separations. For LC/MS separations at low pH, 300StableBond columns can also be used with formic acid and acetic acid mobile phase modifiers. These columns are available in five different bonded phases (C18, C8, C3, CN, and Diphenyl (DP)) for selectivity and recovery optimization of proteins and polypeptides. To further increase sample recovery and improve efficiency for difficult proteins, 300StableBond columns can be used up to 80 °C. StableBond 300SB-C18 and 300SB-C8 columns are an ideal choice for complex protein and protein digest separations. These columns are also available in capillary (0.3 and 0.5 mm id) and nano (0.075 and 0.10 mm id) dimensions for reversed-phase LC/MS separations of protein digests. Capillary and nano columns can be used for either 1D or 2D proteomics separations.

UHPLC Column Specifications

Bonded Phase	Pore Size	Temp Limits*	pH Range*	Endcapped
ZORBAX RRHD 300SB-C18	300Å	90 °C	1.0-8.0	No
ZORBAX RRHD 300SB-C8	300Å	80 °C	1.0-8.0	No
ZORBAX RRHD 300SB-C3	300Å	80 °C	1.0-8.0	No
ZORBAX RRHD 300-Diphenyl	300Å	80 °C	1.0-8.0	Yes
ZORBAX 300SB-C18	300Å	90 °C	1.0-8.0	No
ZORBAX 300SB-C8	300Å	80 °C	1.0-8.0	No
ZORBAX 300SB-C3	300Å	80 °C	1.0-8.0	No
ZORBAX 300SB-CN	300Å	80 °C	1.0-8.0	No

Specifications represent typical values only

*300StableBond columns are designed for optimal use at low pH. At pH 6-8, the highest column stability for all silica-based columns is obtained by operating at temperatures <40 °C and using low buffer concentrations in the range of 0.01-0.02 M. At mid or high pH, 300Extend-C18 is recommended.



Higher resolution of intact monoclonal antibody

Column: ZORBAX RRHD 300SB-C8
857750-906
2.1 x 50 mm, 1.8 μm

Mobile Phase: A: H₂O:IPA (98:2) + 0.1% TFA (v/v)
B: IPA:ACN:H₂O (70:20:10) + 0.1% TFA (v/v)

Flow Rate: Between 0.5 mL/min and 1.0 mL/min

Gradient: Multi-segmented and linear elution

Temperature: 80 °C

Detector: 1290 Infinity LC with auto injector (ALS), binary pump and thermostatted oven and diode array detector (DAD)

Detection: UV, 225 nm

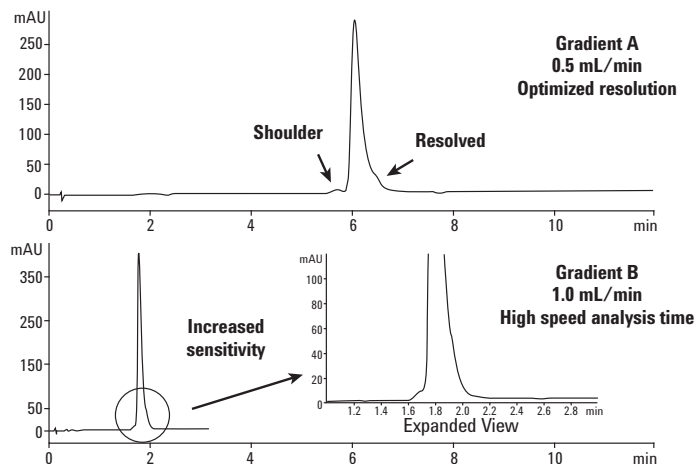

TIPS & TOOLS

For more information on better characterization of biomolecules using Agilent AdvanceBio Reversed-Phase columns, refer to white paper on this topic (publication 5991-2032EN)
www.agilent.com/chem/library

TIPS & TOOLS

Typical mobile phases for protein and peptide separations combine a very low pH with TFA (or other acids) to solubilize proteins. StableBond columns have extremely long lifetimes under these conditions. They are available in 300Å pore size for proteins up to 100-500 kDa.

Reduced & alkylated mAb – separation of light chain and heavy chain variants

Column: ZORBAX RRHD 300SB-C8
858750-906
2.1 x 100 mm, 1.8 µm

Mobile Phase: A: H₂O + 0.1% TFA (v/v)
B: n-propanol:ACN:H₂O (80:10:10) + 0.1% TFA (v/v)

Flow Rate: 0.5 mL/min

Gradient: Multi-segmented

% Solvent B	Time (min)
20	0
35	3
40	4
40	5
90	5.1
90	5.5
25	6

Injection: 3 µL (from 2.5 mg/mL sample)

Temperature: 75 °C

Detector: UV, 225 nm

Instrument: Agilent 1290 Infinity LC with auto injector (ALS), binary pump, thermostatted oven, and diode array detector (DAD)

For consecutive chromatographic runs, a 2 min post run was added to re-equilibrate the column.

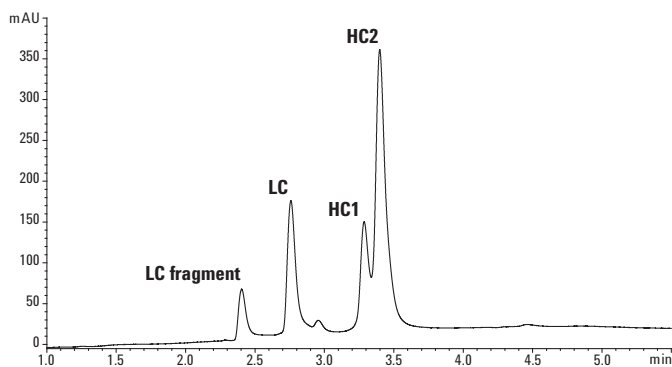

Improved reproducibility of monoclonal antibodies

Column: ZORBAX RRHD 300SB-C8
857750-906
2.1 x 50 mm, 1.8 µm

Mobile Phase: A: H₂O:IPA (98.2), 0.1% TFA
B: IPA:ACN:H₂O (70:20:10), 0.1% TFA

Flow Rate: 1.0 mL/min

Temperature: 80 °C

Detector: 1290 Infinity LC with diode array detector at 225 nm

Sample: mAb

Gradient

Time (min)	% Solvent B
0.00	25
3.00	35
4.00	90
5.00	25

Excellent column reproducibility and protein recovery using Agilent ZORBAX 300SB-C8.

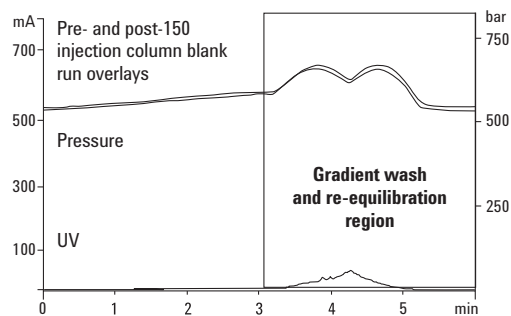
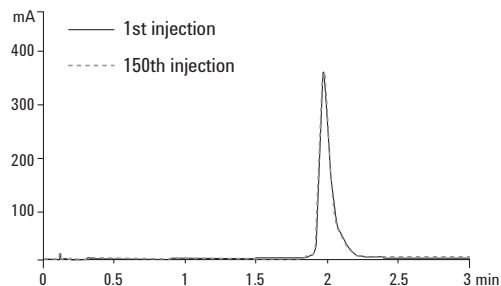

**Unique selectivity choices
for mAb characterization**

Columns: **ZORBAX RRHD 300SB-C18**
 858750-902
 2.1 x 100 mm, 1.8 µm

ZORBAX RRHD 300SB-C3
 858750-909
 2.1 x 100 mm, 1.8 µm

ZORBAX RRHD 300SB-C8
 858750-906
 2.1 x 100 mm, 1.8 µm

ZORBAX RRHD 300-Diphenyl
 858750-944
 2.1 x 100 mm, 1.8 µm

Mobile Phase: A: H₂O (0.1% TFA) (v/v)
 B: 80% nPA:10% ACN:10% H₂O (0.08% TFA) (v/v)

Flow Rate: 1.0 mL/min (3.5 µm*), 1.0 mL/min (1.8 µm)

Gradient: 25-35% B, 90% wash

Temperature: 80 °C

Detector: UV, 215 nm

Injection Volume: 3 µL (from 2.5 mg/mL sample)

* Broad peaks at lower flow rates

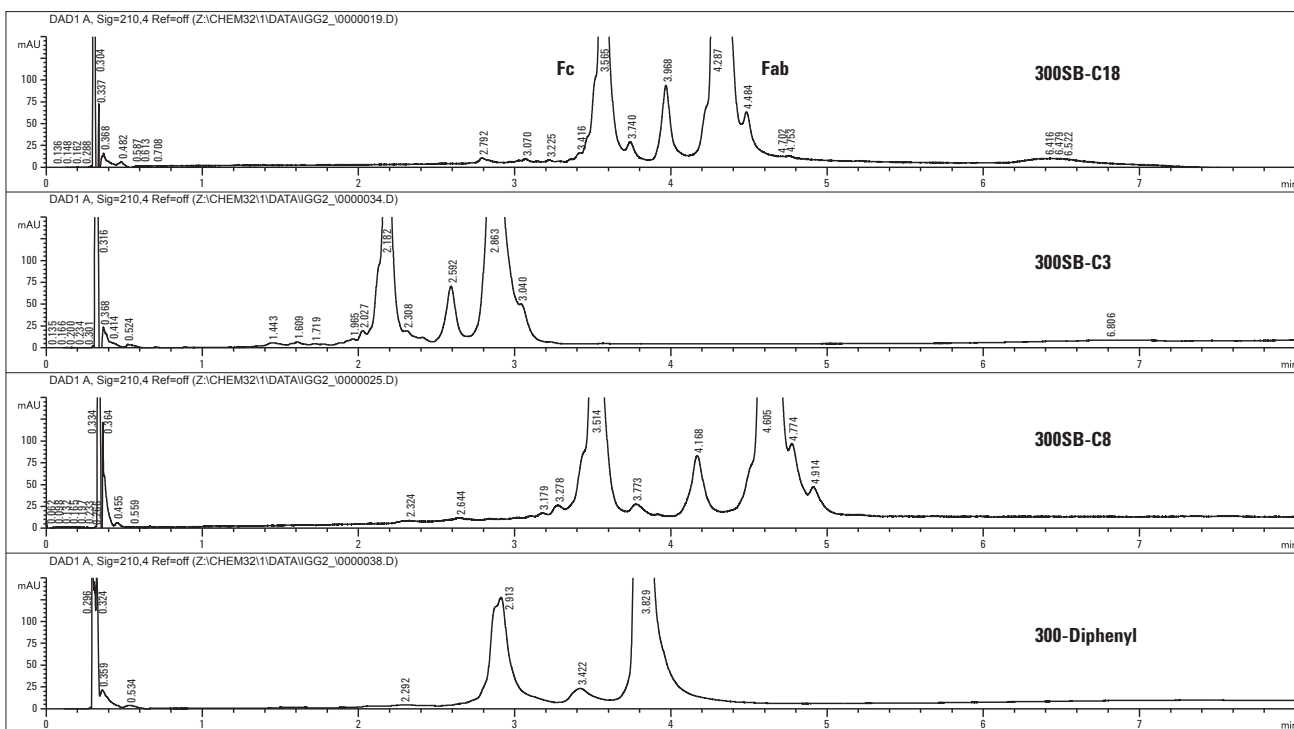

Peptides/proteins: effect of elevated temperature

Column: ZORBAX 300SB-C3
883995-909
4.6 x 150 mm, 5 μ m

Mobile Phase: A: 5:95 ACN:water with 0.10% TFA (v/v%)
B: 95:5 ACN:water with 0.085% TFA (v/v%)

Flow Rate: 1.0 mL/min

Gradient: 15-53% in 20 min, posttime 12 min

Temperature: Ambient – 60 °C

Detector: UV, 215 nm

Sample: Polypeptides

1. Leucine enkephalin
2. Angiotensin II
3. RNase A
4. Insulin (BOV)
5. Cytochrome c
6. Lysozyme
7. Myoglobin
8. Carbonic anhydrase

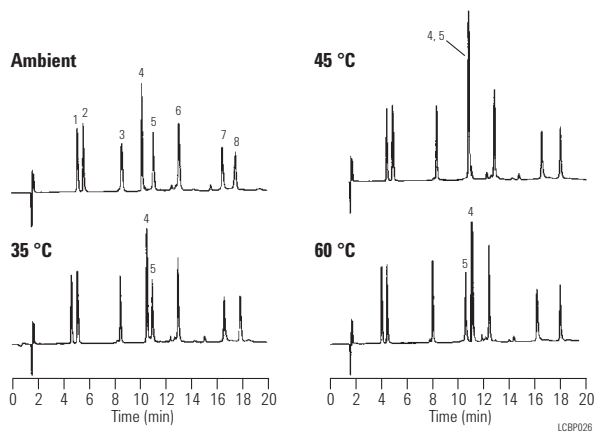

Short-chain ZORBAX 300SB-C3 is stable at low pH, high temperature

Column: ZORBAX 300SB-C3
883995-909
4.6 x 150 mm, 5 μ m

Mobile Phase: Gradient 0-100% B in 80 min
A: 0.5% TFA in water
B: 0.5% TFA in acetonitrile
Isocratic retention test conditions:
1-phenylheptane 50% A, 50% B

Flow Rate: 1.0 mL/min

Temperature: 60 °C

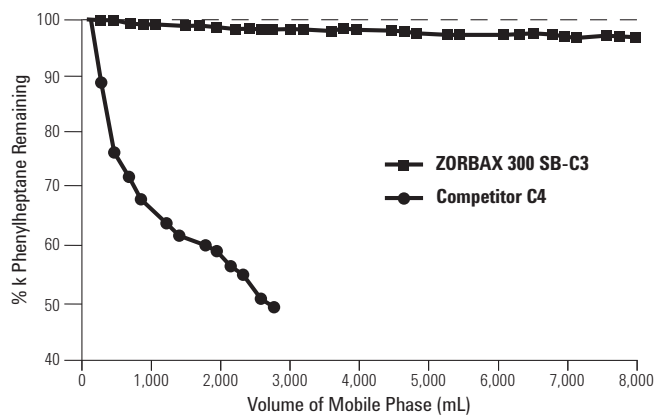

Four different 300SB bonded phases optimize separation of large polypeptides

Column A: ZORBAX RRHD 300SB-C18
883995-902
4.6 x 150 mm, 5 µm

Column B: ZORBAX 300SB-C8
883995-906
4.6 x 150 mm, 5 µm

Column C: ZORBAX 300SB-C3
883995-909
4.6 x 150 mm, 5 µm

Column D: ZORBAX 300SB-CN
883995-905
4.6 x 150 mm, 5 µm

Mobile Phase: Linear gradient, 25-70% B in 40 min
A: 0.1% TFA in water
B: 0.09% TFA in 80% acetonitrile:20% water

Flow Rate: 1.0 mL/min

Temperature: 60 °C

Sample: 3 µg each protein

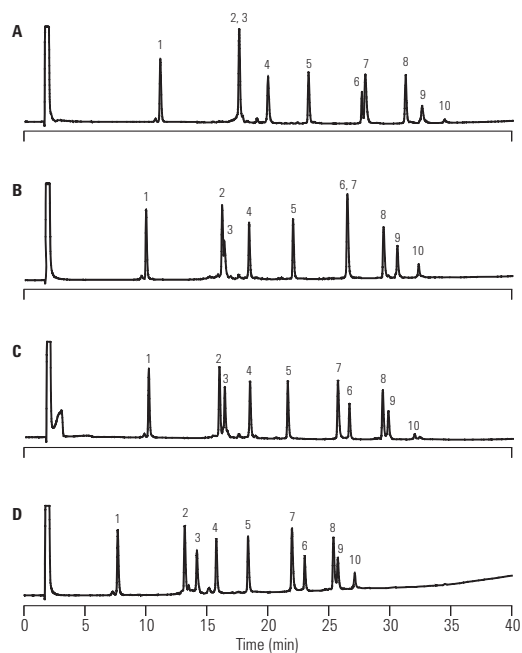

The 300SB-C18, C8, C3, and CN bonded phases all provide a different separation of this group of polypeptides. This adds an important parameter for quickly optimizing protein separations. The 300SB-CN column offers unique selectivity for more hydrophilic polypeptides.

TIPS & TOOLS

The Agilent 1290 Infinity LC delivers significantly faster results and higher data quality – enabling more informed decisions in shorter time. This higher productivity gives you competitive advantages and provides you a higher return on investment. Calculate for yourself how much you can save by deploying the 1290 Infinity technology. The online method translator and cost savings calculator helps you to transfer your HPLC methods and calculate your cost savings, at www.agilent.com/chem/hplc2uhplc

ZORBAX 300Å StableBond

Hardware	Description	Size (mm)	Particle Size (µm)	300SB-C18 USP L1	300SB-C8 USP L7	300SB-CN USP L10	300SB-C3 USP L56	300-Diphenyl USP L11
Standard Columns (no special hardware required)								
	Semi-Preparative	9.4 x 250	5	880995-202	880995-206	880995-205	880995-209	
	Analytical	4.6 x 250	5	880995-902	880995-906	880995-905	880995-909	
	Analytical	4.6 x 150	5	883995-902	883995-906	883995-905	883995-909	
	Analytical	4.6 x 50	5	860950-902	860950-906	860950-905	860950-909	
	Rapid Resolution	4.6 x 150	3.5	863973-902	863973-906	863973-905	863973-909	
	Rapid Resolution	4.6 x 100	3.5	861973-902	861973-906			
	Rapid Resolution	4.6 x 50	3.5	865973-902	865973-906	865973-905	865973-909	
	Solvent Saver Plus	3.0 x 150	3.5	863974-302	863974-306		863974-309	
	Solvent Saver Plus	3.0 x 100	3.5		861973-306			
	Narrow Bore	2.1 x 250	5	881750-902				
	Narrow Bore	2.1 x 150	5	883750-902	883750-906	883750-905	883750-909	
	Narrow Bore RR	2.1 x 150	3.5		863750-906			
	Narrow Bore RR	2.1 x 100	3.5	861775-902	861775-906			
	Narrow Bore RR	2.1 x 50	3.5	865750-902	865750-906			
	Narrow Bore RRHD	2.1 x 100	1.8	858750-902	858750-906		858750-909	858750-944
	Narrow Bore RRHD	2.1 x 50	1.8	857750-902	857750-906		857750-909	857750-944
	MicroBore	1.0 x 250	5	861630-902				
	MicroBore RR	1.0 x 150	3.5	863630-902	863630-906			
	MicroBore RR	1.0 x 50	3.5	865630-902	865630-906			
	MicroBore Guard, 3/pk	1.0 x 17	5	5185-5920	5185-5920			
P	Guard Cartridge, 2/pk	9.4 x 15	7	820675-124	820675-124	820675-124	820675-124	
ZGC	Guard Cartridge, 4/pk	4.6 x 12.5	5	820950-921	820950-918	820950-923	820950-924	
ZGC	Guard Cartridge, 4/pk	2.1 x 12.5	5	821125-918	821125-918	821125-924	821125-924	
P	Guard Hardware Kit			840140-901	840140-901	840140-901	840140-901	
ZGC	Guard Hardware Kit			820999-901	820999-901	820999-901	820999-901	

(Continued)

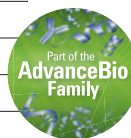









TIPS & TOOLS

For key biopharma resources to make the most of your Agilent instruments, by providing you with information and tools to maximize its use, visit:

www.agilent.com/chem/getbioguides

ZORBAX 300Å StableBond

Hardware	Description	Size (mm)	Particle Size (µm)	300SB-C18 USP L1	300SB-C8 USP L7	300SB-CN USP L10	300SB-C3 USP L56	300-Diphenyl USP L11
PrepHT Cartridge Columns (require endfittings kit 820400-901)								
	PrepHT Cartridge	21.2 x 250	7	897250-102	897250-106	897250-105	897250-109	
	PrepHT Cartridge	21.2 x 150	7	897150-102	897150-106		897150-109	
	PrepHT Cartridge	21.2 x 150	5	895150-902	895150-906		895150-909	
	PrepHT Cartridge	21.2 x 100	5	895100-902	895100-906		895100-909	
	PrepHT Cartridge	21.2 x 50	5	895050-902	895050-906		895050-909	
	PrepHT Endfittings, 2/pk			820400-901	820400-901	820400-901	820400-901	
	PrepHT Guard Cartridge, 2/pk	17.0 x 7.5	5	820212-921	820212-918	820212-924	820212-924	
	Guard Cartridge Hardware			820444-901	820444-901	820444-901	820444-901	
Capillary Glass-lined Columns								
	Capillary	0.5 x 250	5	5064-8266				
	Capillary	0.5 x 150	5	5064-8264				
	Capillary	0.5 x 35	5	5064-8294				
	Capillary RR	0.5 x 150	3.5	5064-8268				
	Capillary RR	0.5 x 35	3.5	5065-4459				
	Capillary	0.3 x 250	5	5064-8265				
	Capillary	0.3 x 150	5	5064-8263				
	Capillary	0.3 x 35	5	5064-8295				
	Capillary RR	0.3 x 150	3.5	5064-8267	5065-4460			
	Capillary RR	0.3 x 100	3.5	5064-8259	5065-4461			
	Capillary RR	0.3 x 35	3.5	5064-8270	5065-4462			
	Capillary RR	0.3 x 50	3.5	5064-8300	5065-4463			
Nano Columns (PEEK fused silica)								
	Nano RR	0.1 x 150	3.5	5065-9910				
	Nano RR	0.075 x 150	3.5	5065-9911				
	Nano RR	0.075 x 50	3.5	5065-9924	5065-9923			
	Trap/Guard, 5/pk	0.3 x 5	5	5065-9913	5065-9914			
	Trap/Guard Hardware kit			5065-9915	5065-9915			

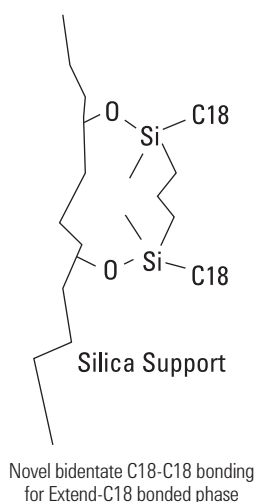

ZORBAX 300Å Extend-C18

- Rugged, high and low pH separations of polypeptides and peptides from pH 2-11.5
- Different selectivity possible at high and low pH
- High efficiency and good recovery of hydrophobic peptides at high pH
- Ideal for LC/MS with ammonium-hydroxide-modified mobile phase

Agilent ZORBAX 300Å Extend-C18 is a wide-pore HPLC column for high efficiency separations of peptides from pH 2-11.5. The unique, bidentate bonded phase provides excellent lifetime and reproducibility at high and low pH. At high pH, retention and selectivity of peptides and polypeptides can change dramatically as a result of changes in charge on molecules. Excellent recoveries of hydrophobic polypeptides have been achieved at room temperature and high pH. LC/MS sensitivity of peptides and polypeptides can also be improved at high pH using a simple ammonium-hydroxide-containing mobile phase.

UHPLC Column Specifications

Bonded Phase	Pore Size	Temp Limits*	pH Range	Endcapped
ZORBAX 300Å Extend-C18	300Å	60 °C	2.0-11.5	Double

Specifications represent typical values only

*Temperature limits are 60 °C up to pH 8, 40 °C from pH 8-11.5.



TIPS & TOOLS

Selecting the right column is only part of the total solution. Don't forget key supplies such as our wide range of LC lamps.

LC/MS analysis of angiotensin

Column: ZORBAX Extend-C18
773700-902
2.1 x 150 mm, 5 µm

Mobile Phase: Acidic conditions:
A: 0.1% TFA in water
B: 0.085% TFA in 80% acetonitrile (ACN)
Basic conditions:
A: 10 mM NH₄OH in water
B: 10 mM NH₄OH in 80% ACN

Flow Rate: 0.2 mL/min

Gradient: 15-50% B in 15 min

Temperature: 35 °C

MS Conditions: Pos. ion ESI; Vf 70 V, Vcap 4.5 kV,
N₂, 35 psi, 12 L/min, 325 °C

Sample: Angiotensin I, II, III, 2.5 µL sample
(50 pmol each)

A
Angiotensin I
Max: 10889
Low pH

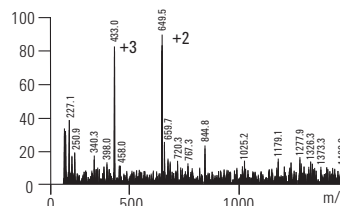
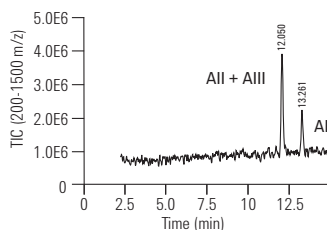

B
Angiotensin I
Max: 367225
High pH

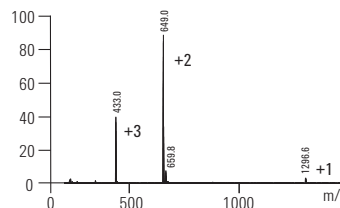
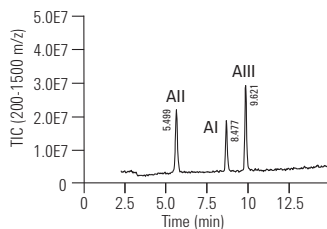

LC30003

Both small and large peptides demonstrate selectivity changes at high and low pH. At high pH, due to a change in charge, all three angiotensins can be resolved. In addition, the spectral clarity of angiotensin I is dramatically improved at high pH with the ammonium hydroxide mobile phase. The Extend-C18 column can be used for the analysis of small peptides at high pH as well.

Reference: B.E. Boyes. Separation and Analysis of Peptides at High pH Using RP-HPLC/ESI-MS, 4th WCBP, San Francisco, CA, Jan. 2000.

Long life at high pH

Column: ZORBAX Extend-C18
773450-902
4.6 x 150 mm, 5 µm

Mobile Phase: 20% 20 mM NH₄OH, pH 10.5
80% methanol

Flow Rate: 1.5 mL/min

Temperature: Aging 24 °C
Tests 40 °C

Each 10,000 column volume is approximately one working month.

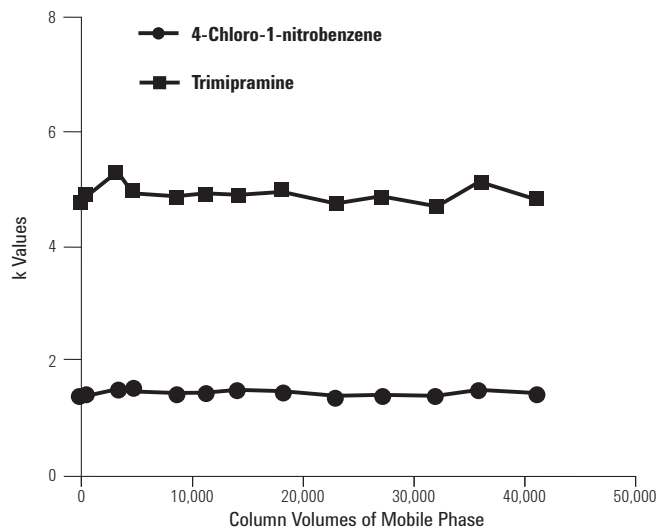

LC30001

Use ZORBAX Extend-C18 for alternate selectivity at high pH

Column: ZORBAX Extend-C18
773700-902
2.1 x 150 mm, 5 µm

Mobile Phase: A: 0.1% TFA in water
B: 0.085% TFA in 80% ACN

A: 20 mM NH₄OH in water
B: 20 mM NH₄OH in 80% ACN

Flow Rate: 0.25 mL/min

Gradient: 5-60% B in 20 min

Temperature: 25 °C

MS Conditions: Pos. ion ESI; Vf 70 V, Vcap 4.5 kV,
N₂, 35 psi, 12 L/min, 300 °C
4 µL (50 ng each peptide)

The Extend column can be used for high pH separations of peptides. At high and low pH very different selectivity can result. Just by changing pH, a complementary method can be developed and it is possible to determine if all peaks are resolved. The Extend column can be used at high and low pH, and so the complementary separation can be investigated with one column. Better MS sensitivity for this sample is also achieved at high pH.

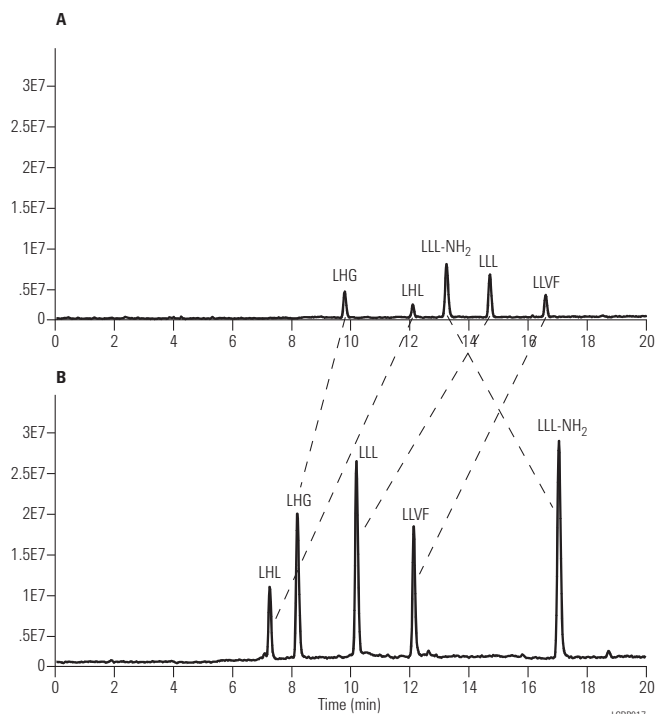

LCBP017

ZORBAX 300Å Extend-C18

Hardware	Description	Size (mm)	Particle Size (µm)	Part No.
	Analytical	4.6 x 250	5	770995-902
	Analytical	4.6 x 150	5	773995-902
	Rapid Resolution	4.6 x 150	3.5	763973-902
	Rapid Resolution	4.6 x 100	3.5	761973-902
	Rapid Resolution	4.6 x 50	3.5	765973-902
	Narrow Bore RR	2.1 x 150	3.5	763750-902
	Narrow Bore RR	2.1 x 100	3.5	761775-902
	Narrow Bore RR	2.1 x 50	3.5	765750-902
ZGC	Guard Cartridge, 4/pk	4.6 x 12.5	5	820950-932
ZGC	Guard Cartridge, 4/pk	2.1 x 12.5	5	821125-932
ZGC	Guard Hardware Kit			820999-901
Capillary Glass-lined Columns				
	Capillary RR	0.3 x 150	3.5	5065-4464
	Capillary RR	0.3 x 100	3.5	5065-4465
	Capillary RR	0.3 x 75	3.5	5065-4466
	Capillary RR	0.3 x 50	3.5	5065-4467

TIPS & TOOLS

Guard columns and filters help protect your column and instruments from particulates that can cause blockages, which increase system pressure and negatively impact performance – interrupting your daily workflow. Agilent's new Fast Guards for UHPLC and Bio LC columns help protect the column, leading to longer column lifetimes, minimizing interruptions in your workflow. For more information, visit: www.agilent.com/chem/fastguards



Solid core, 4.5 μm diameter

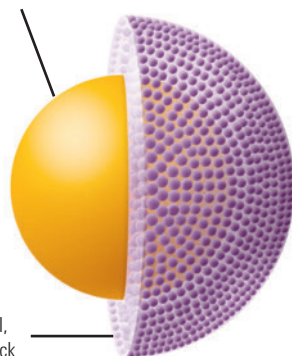

Porous shell,
0.25 μm thick

Poroshell 300

- High speed separations of biomolecules with superficially porous particles
- 300Å pores provide high efficiency and recovery with proteins (up to 1,000 kDa)
- Achieve long lifetime at low pH with Poroshell 300SB; at high pH with 300Extend-C18
- Optimize recovery and selectivity with four different bonded phases – 300SB-C18, 300SB-C8, 300SB-C3, and 300Extend-C18

Agilent Poroshell 300 columns are ideal for fast separations of proteins and peptides because the 5 μm diameter superficially porous particle allows for fast flow rates to be used while maintaining sharp, efficient peaks. Poroshell columns with StableBond bonded phases provide excellent stability and selectivity choices with TFA and formic acid mobile phases. The Poroshell 300Extend-C18 column can be used from pH 2-11 for unique separations. These columns can also be used for analytical protein separations and LC/MS separations.

Peptides and proteins are typically separated slowly to reduce the potential peak broadening of these slow diffusing analytes. However, Poroshell columns use a superficially porous particle made with a thin layer of porous silica, 0.25 μm thick, on a solid core of silica. This reduces the diffusion distance for proteins, making rapid HPLC separations of peptides and proteins up to 500-1,000 kDa possible with 400/600 bar HPLC systems, including the Agilent 1260 Infinity Bio-inert Quaternary LC.



Poroshell 300 Columns

UHPLC Column Specifications

Bonded Phase	Pore Size	Temp Limits*	pH Range	Endcapped
Poroshell 300SB-C18, C8, C3	300Å	90 °C	1.0-8.0	No
Poroshell 300Extend-C18	300Å	40 °C above pH 8 60 °C below pH 8	2.0-11.0	Yes

Specifications represent typical values only

*300StableBond columns are designed for optimal use at low pH. At pH 6-8, the highest column stability for all silica-based columns is obtained by operating at temperatures <40 °C and using low buffer concentrations in the range of 0.01-0.02 M. At mid or high pH, 300Extend-C18 is recommended.

Poroshell 300 columns separate proteins and peptides in seconds

Column: Poroshell 300SB-C18
660750-902
2.1 x 75 mm, 5 µm

Mobile Phase: A: 0.1% TFA in H₂O
B: 0.07% TFA in ACN

Flow Rate: 3.0 mL/min

Gradient: 5-100% B in 1.0 min

Temperature: 70 °C, 260 bar

Detector: UV, 215 nm

Sample: Proteins and peptides

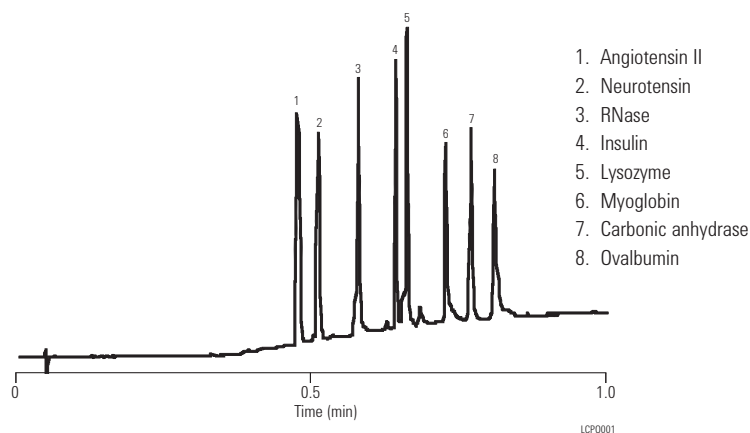

This separation of eight polypeptides and proteins is completed in less than 60 seconds. Each peak is sharp and efficient.

TIPS & TOOLS

Further information can be found in:

Characterization of Glycosylation in the Fc Region of Therapeutic Recombinant Monoclonal Antibody (publication 5991-2323EN)

Use of Temperature to Increase Resolution in the Ultrafast HPLC Separation of Proteins with ZORBAX Poroshell 300SB-C8 HPLC Columns (publication 5989-0589EN)

Using the High-pH Stability of ZORBAX Poroshell 300Extend-C18 to Increase Signal-to-Noise in LC/MS (publication 5989-0683EN)

www.agilent.com/chem/library

Rapid high resolution analysis of fragmented IgG

Column: Poroshell 300SB-C3
660750-909
2.1 x 75 mm, 5 µm

Mobile Phase: A: Water (5% AcOH, 1.0% FA, 0.05% TFA)
B: 70/20/10 IPA:ACN:water
(5% AcOH, 1.0% FA, 0.05% TFA)

Injection Volume: 2 µL

Flow Rate: 1.0 mL/min

Gradient: Segmented

Time (min)	% B
0	20
4	45
8	45
9	90
10	20

Temperature: 80 °C

Detector: UV, 280 nm

Instrument: Agilent 1200 Infinity Series with auto injector (High Performance Autosampler), binary pump, thermostatted oven (TCC), and diode array detector (DAD) coupled to an Agilent 6224 Accurate-Mass TOF LC/MS

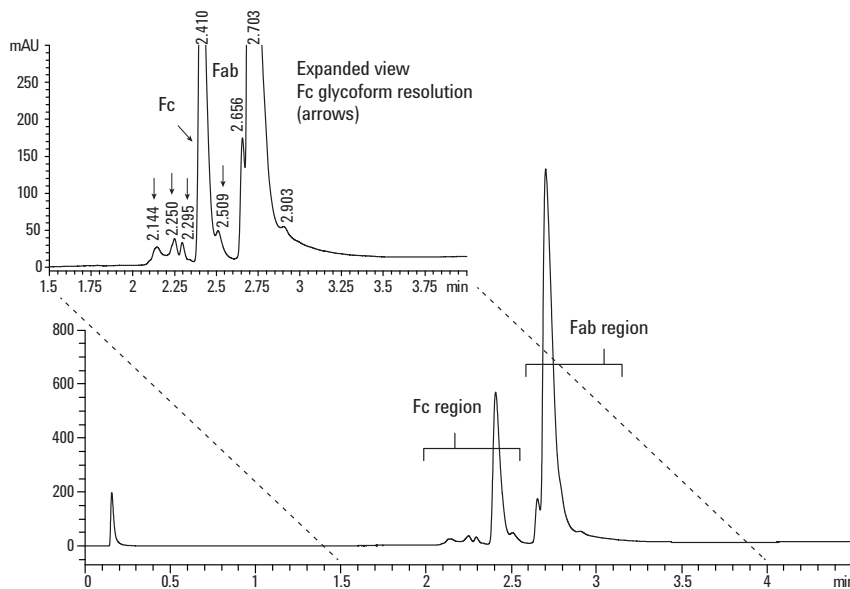

Reversed-phase separation of IgG1 after papain digestion showing two primary peaks of the Fc and Fab fragments. The inset details partially resolved peaks representing variants of the Fc and Fab fragments (arrows).



TIPS & TOOLS

Agilent offers an extensive selection of certified chromatography sample vials including polypropylene and deactivated and siliconized glass. For more information see publication 5990-9022EN.

www.agilent.com/chem/library

MicroBore Poroshell 300 columns provide maximum sensitivity for LC/MS

Column: Poroshell 300SB-C18
661750-902
1.0 x 75 mm, 5 µm

Mobile Phase: A: Water + 0.1% formic acid
 B: ACN + 0.1% formic acid

Flow Rate: 600 µL/min

Gradient: 20-100% B in 5.5 min

Temperature: 80 °C

MS Conditions: LC/MS: Pos. ion ESI; Vcap 6,000 V
 Drying gas flow: 12 L/min
 Drying gas temperature: 350 °C
 Nebulizer: 45 psi
 Fragmentor voltage: 140 V
 Scan: 600-2,500
 Stepsize: 0.15 amu
 Peak width: 0.06 min

Sample: 1 µL

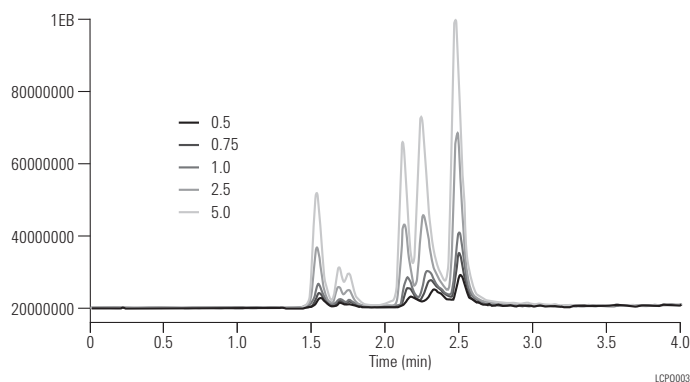

With narrow bore diameters of 2.1 mm, 1.0 mm, and 0.5 mm, Poroshell columns make an ideal LC/MS partner. When the sample is very limited, the 1.0 mm or 0.5 mm id Poroshell columns are an excellent choice for high sensitivity LC/MS analyses. Sensitive MS molecular weight determinations are possible with as little as 0.5 to 5 pmole of protein on Poroshell columns. The columns have also been used for rapid MS identification of intact proteins, even in the presence of stabilizers and tissue culture media.

Monoclonal IgG1 chains

Column: Poroshell 300SB-C8
660750-906
2.1 x 75 mm, 5 µm

Mobile Phase: A: 90% water: 10% ACN + 3 mL/L of MW 300 PEG
 B: 10% water: 90% ACN + 3 mL/L of MW 300 PEG

Flow Rate: 1.0 mL/min

Gradient: 0 min 25% B
 10 min 40% B
 10.1 min 25% B
 12 min 25% B

Temperature: 70 °C

Sample: Monoclonal IgG1

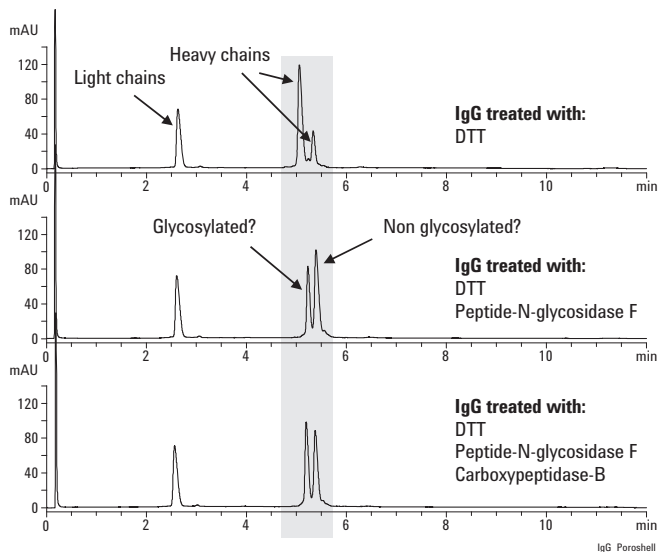

Courtesy of:
 Novartis AG, Basel.
 Dr. Kurt Forrer
 Patrik Roethlisberger

Protein elution patterns

Column: Poroshell 300SB-C8
660750-906
2.1 x 75 mm, 5 µm

Mobile Phase: A: 0.1% TFA in H₂O
B: 0.1% TFA in ACN

Flow Rate: 1.0 mL/min

Gradient: 20 to 70% B in 3 min

Detector: UV, 214 nm

Column Temperature 40 °C

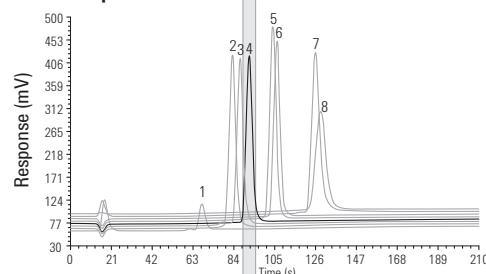

1. Glycoprotein X, MW ~22 kDa
2. Protein I, MW ~4 kDa
3. Glucagon, MW ~3.5 kDa
4. Biosynthetic human insulin, MW ~6 kDa
5. Protein J, MW ~3 kDa
6. Protein K, MW ~6 kDa
7. Glycoprotein Y, MW ~45 kDa
8. Glycoprotein Z, MW ~30 kDa

Column Temperature 60 °C

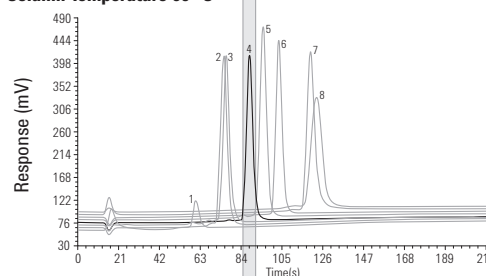

Column Temperature 75 °C

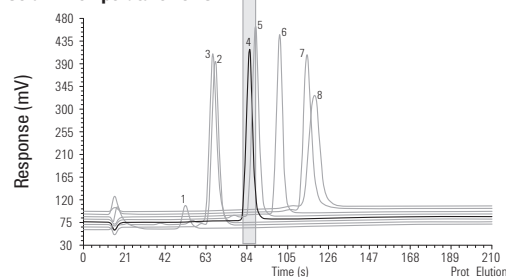

Poroshell 300

Hardware	Description	Size (mm)	Particle Size (µm)	Poroshell 300SB-C18	Poroshell 300SB-C8	Poroshell 300SB-C3	Poroshell 300Extend-C18
	Narrow Bore	2.1 x 75	5	660750-902	660750-906	660750-909	670750-902
	MicroBore	1.0 x 75	5	661750-902	661750-906	661750-909	671750-902
	Capillary	0.5 x 75	5		5065-4468		
	Guard Cartridge, 4/pk	2.1 x 12.5	5	821075-920	821075-918	821075-924	
	Guard Hardware Kit			820999-901	820999-901	820999-901	
	MicroBore Guard, 3/pk	1.0 x 17	5	5185-5968	5185-5968	5185-5968	5185-5968



AdvanceBio Peptide Mapping

- Greater analytical confidence: Each batch of AdvanceBio Peptide Mapping media is tested with a rigorous peptide mix to ensure suitability and reproducibility, and to enable the identification of key peptides in complex peptide maps
- Save time: 2 to 3 times faster than fully porous HPLC columns
- Every instrument works harder: 4.6, 3.0, and 2.1 mm id columns are stable to 600 bar, enabling you to get the most from your UHPLC instruments. They can also deliver excellent performance for your legacy 400 bar instruments, too
- Increased flexibility: Achieve increased MS sensitivity with formic acid mobile phases on any HPLC

These advanced biocolumns feature a 120Å pore size with superficially porous 2.7 µm particles. They are specially tested with a challenging peptides mix to ensure reliable peptide mapping performance. In addition, AdvanceBio Peptide Mapping columns deliver exceptional resolution and speed for UHPLC, and excellent results for conventional HPLC.

Column Specifications

Bonded Phase	Pore Size	Temp Limits	pH Range	Endcapped
EC-C18	120Å	60 °C	2.0-8.0	Double

Specifications represent typical values only

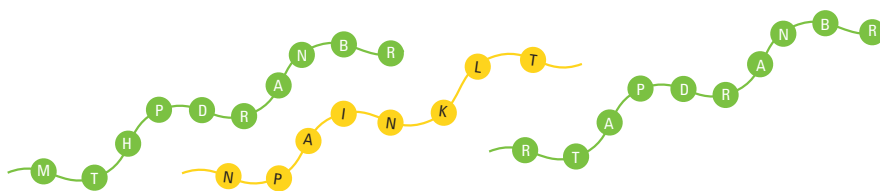

TIPS & TOOLS

Do you want to know how scientists are using the AdvanceBio Peptide Mapping column? Refer to: Amano, M. *et al.* Detection of Histidine Oxidation in a Monoclonal Immunoglobulin Gamma (IgG) 1 Antibody. *Analytical Chemistry*, 2014, 86 (15): 7536–7543

Leah G. Luna and Katherine Coody, Identification of *X. laevis* Vitellogenin Peptide Biomarkers for Quantification by Liquid Chromatography Tandem Mass Spectrometry. *J. Anal Bioanal Tech*, 2014, 5:3

For more such articles on use of Agilent's products, refer to the citations in the appendix.

High resolution peptide map of erythropoietin digest

Column: AdvanceBio Peptide Mapping
651750-902
2.1 x 250 mm, 2.7 μ m

Mobile Phase: A: H₂O + 0.1% formic acid (v/v)
B: Acetonitrile + 0.1% formic acid (v/v)

Flow Rate: 0.4 mL/min

Gradient:	Time (min)	% B
	0	3
	28	45
	33	60
	34	95

Temperature: 55 °C

Injection: 5 μ L (2 μ g/ μ L)

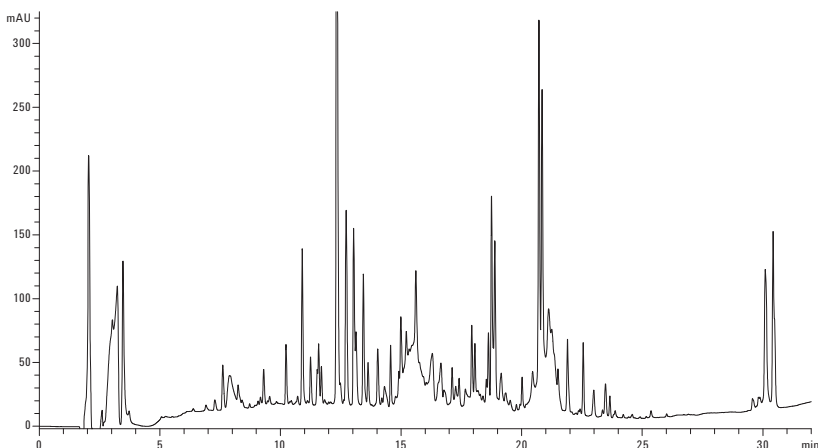

Fast and efficient peptide mapping of IgG

Columns: AdvanceBio Peptide Mapping
655750-902
2.1 x 100 mm, 2.7 μ m

AdvanceBio Peptide Mapping
653750-902
2.1 x 150 mm, 2.7 μ m

Mobile Phase: A: H₂O + 0.1% FA (v/v)
B: 90% ACN + 0.1% FA (v/v)

Flow Rate: Various

Temperature: 40 °C

Detector: UV, 215/220 nm

Injection Volume: 15 μ L

Instrument: Agilent 1290 Infinity LC
and an Agilent 6530 Accurate-Mass
Quadrupole Time-of-Flight (Q-TOF)

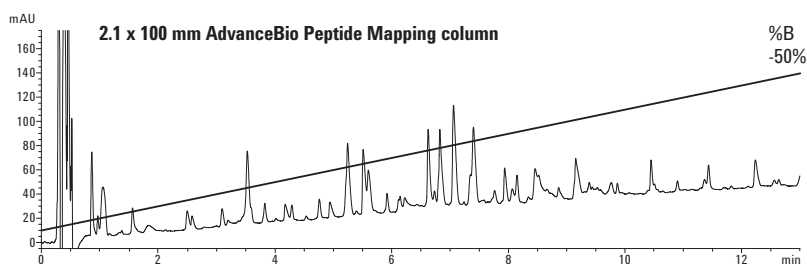
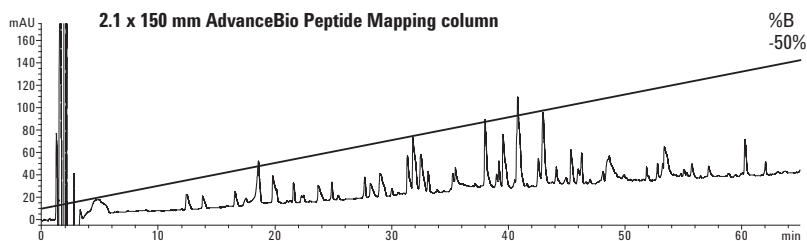

AdvanceBio Peptide Mapping column optimization for achieving a faster peptide mapping analysis. Gradient 10-40% B, DAD: 215 nm, 40 °C. Top panel, 75 min separation on a 2.1 x 150 mm column generated 59 peptide peaks (flow rate 0.2 mL/min, 211 bar). Bottom panel, optimized 14 min separation on a 2.1 x 100 mm column generated 57 peptide peaks (flow rate 0.6 mL/min, 433 bar).

Quality assurance testing with Agilent peptide mix

Column: AdvanceBio Peptide Mapping
653750-902
2.1 x 150 mm, 2.7 μ m

Flow Rate: 0.5 mL/min

Injection: 3 μ L

Gradient: A, water (0.1% TFA), B, ACN (0.1% TFA), 0-25 min,
15-65% B; 25-26 min, 65-95% B

Temperature: 55 $^{\circ}$ C

Detector: 220 nm

Sample: Agilent Peptide Mapping Standards Mix (0.5-1.0
 μ g/ μ L per peptide) p/n 5190-0583

Test mix used for every batch of AdvanceBio Peptide Mapping media. The mixture contains 10 hydrophilic, hydrophobic, and basic peptides, ranging in molecular weight from 757 to 2845 Da. Every column is also tested with a small-molecule probe to ensure efficiency.

1. Bradykin frag (1-7)
2. Bradykin acetate
3. Angiotensin II
4. Neurotensin
5. Angiotensin I
6. Renin
7. [Ace-F-3,-2 H-1] Angiotensin (1-14)
8. Ser/Thr Protein phosphatase (15-31)
9. [F14] Ser/Thr Protein phosphatase (15-31)
10. Mellitin (honey bee venom)

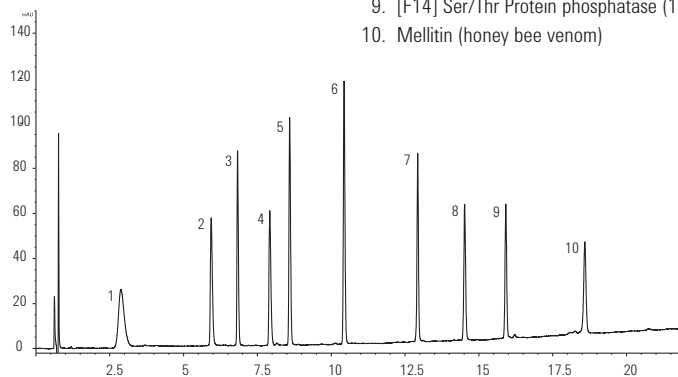

Lot-to-lot reproducibility after 200 injections

Column: AdvanceBio Peptide Mapping
651750-902
2.1 x 250 mm, 2.7 μ m

Flow Rate: 0.5 mL/min

Gradient: A, water (0.1% TFA), B, ACN (0.08% TFA), 0-8 min,
10-60% B; 8.1-9 min, hold 95% B

Temperature: 55 °C

Detector: 220 nm

Injection: 1 μ L

Sample: Sigma HPLC peptide standards

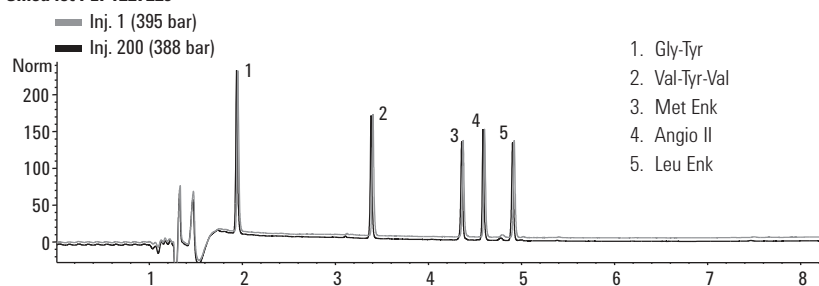
Silica lot PEP1227229

Injection	RT2 (min)	RT3 (min)	RT4 (min)	RT5 (min)
1	3.39	4.36	4.59	4.90
200	3.52	4.48	4.70	5.02

Injection	PW2	PW3	PW4	PW5
1	0.020	0.021	0.020	0.022
200	0.020	0.021	0.019	0.021

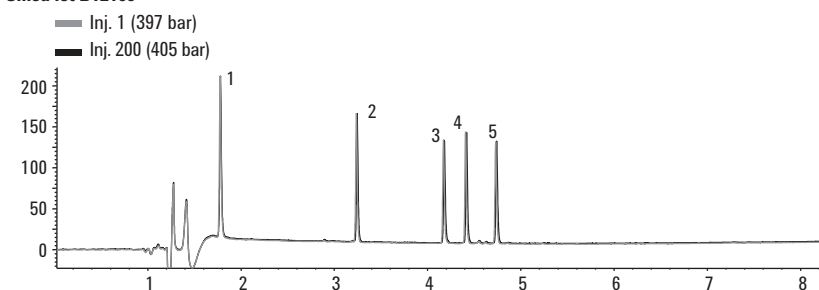
Silica lot B12169

Injection	RT2 (min)	RT3 (min)	RT4 (min)	RT5 (min)
1	3.36	4.29	4.52	4.85
200	3.24	4.18	4.41	4.74

Injection	PW2	PW3	PW4	PW5
1	0.019	0.020	0.019	0.020
200	0.019	0.020	0.019	0.020

Superior reproducibility, lot-to-lot and run-to-run. A 2.1 x 250 mm AdvanceBio Peptide Mapping column was used for maximum resolution.

AdvanceBio Peptide Mapping

Description	Part No.
4.6 x 150 mm, 2.7 µm	653950-902
3.0 x 150 mm, 2.7 µm	653950-302
2.1 x 250 mm, 2.7 µm	651750-902
2.1 x 150 mm, 2.7 µm	653750-902
2.1 x 100 mm, 2.7 µm	655750-902
4.6 x 5 mm, Fast Guard*	850750-911
3.0 x 5 mm, Fast Guard*	853750-911
2.1 x 5 mm, Fast Guard*	851725-911

* Fast Guards extend column lifetime without slowing down the separation or affecting resolution.

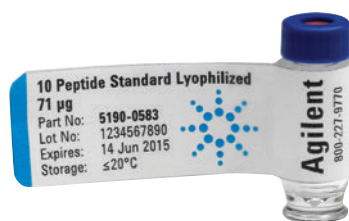
**Agilent Peptide Quality Control Standard**

Use Agilent's ten-peptide quality control standard, the same standard Agilent uses to QC its columns, to evaluate your column performance over its lifetime. It can be used for HPLC or LC/MS. Approximately 20 injections per vial.

Agilent Peptide Quality Control Standard

Description	Part No.
Peptide quality control standard, 71 µg in 2 mL vial	5190-0583

TIPS & TOOLS

Peptide mapping is a powerful technique and the most widely used identity test for proteins, particularly those produced by recombinant means. There are several considerations to be made in addition to column selection for reproducible and accurate peptide maps, including protein digestion, sample prep, method optimization, and so on. For fundamental techniques used for peptide mapping procedures and emphasized considerations for optimizing your peptide mapping separations to achieve the best possible results, see *Keys for Enabling Optimum Peptide Characterizations: A Peptide Mapping "How to" Guide* (publication 5991-2348EN)

www.agilent.com/chem/library

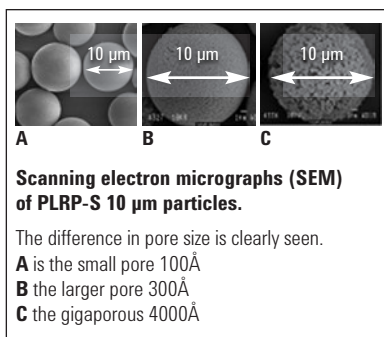

PLRP-S

- Contain durable and resilient polymer particles that deliver reproducible results over longer lifetimes
- Thermally and chemically stable
- Comply with USP L21 designation
- Used in bioscience, chemical, clinical research, energy, environmental, food and agriculture, material science, and pharmaceutical industries
- Pore sizes (100Å-4000Å) for separations of small molecules to large complexes and polynucleotides

The PLRP-S family of columns consists of a range of pore sizes and particle sizes, all with identical chemistry and fundamental adsorptive characteristics. The particles are inherently hydrophobic. Therefore, no bonded phase or alkyl ligand is required for reversed-phase separations. This gives a highly reproducible material that is free from silanols and heavy metal ions. Columns within the extensive product range are suitable for micro separations, including bottom-up and top-down proteomics, analytical separations, and preparative purifications. In addition, process columns can be packed with bulk media.

Column Specifications

pH range	1-14
Buffer content	Unlimited
Organic modifier	1-100%
Temperature limits	200 °C
Maximum pressure	5-8 µm: 3,000 psi (210 bar) 3 µm: 4,000 psi (300 bar)

PLRP-S Applications

Pore Size	Application
100Å	Small molecules/synthesis
300Å	Recombinant peptides/proteins
1000Å	Large proteins
4000Å	DNA/high speed

HPLC of 25 bp DNA ladder**Column:** PLRP-S, 2.1 x 150 mmMobile Phase: A: 100 mM TEAA
B: 100 mM TEAA in 50% water:50% ACN

Flow Rate: 200 µL/min

Gradient: 12.5-50% B in 150 min

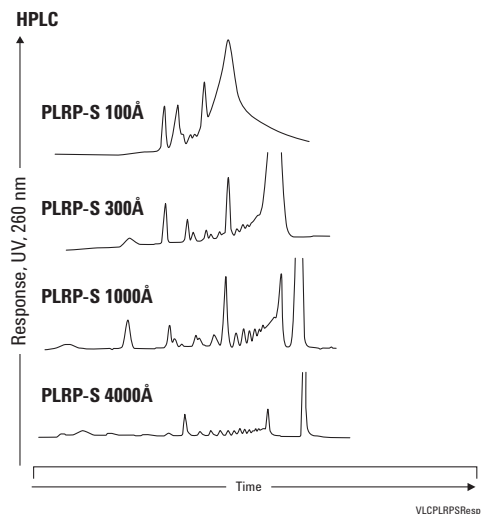
**Polyethylene glycols****Column:** PLRP-S 100Å
PL1111-3500
4.6 x 150 mm, 5 µmMobile Phase: A: Water
B: ACN

Gradient: 10-30% B in 12 min, held at 30% B for 3 min

Flow Rate: 1.0 mL/min

Injection Volume: 10 µL

Sample Conc: 1 mg/mL

Detector: ELS (neb=50 °C, evap=70 °C, gas=1.6 SLM)

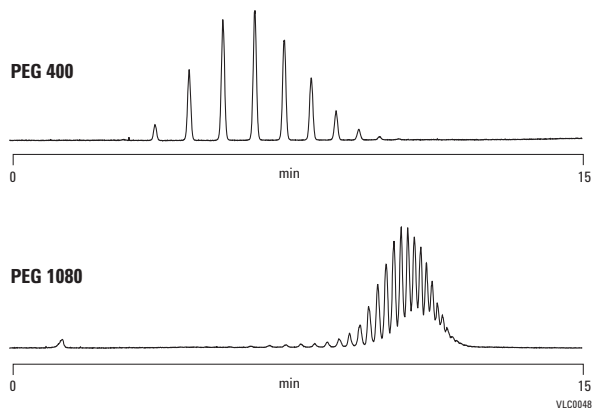
**Exploiting chemical stability –
TFA concentration****Column:** PLRP-S 100Å
PL1512-5500
4.6 x 250 mm, 5 µmMobile Phase: A: TFA (various %) in water
B: TFA (various %) in ACN

Gradient: Linear 12-40% B in 15 min

Flow Rate: 1.0 mL/min

Detector: ELS (neb=75 °C, evap=85 °C, gas=1.0 SLM)

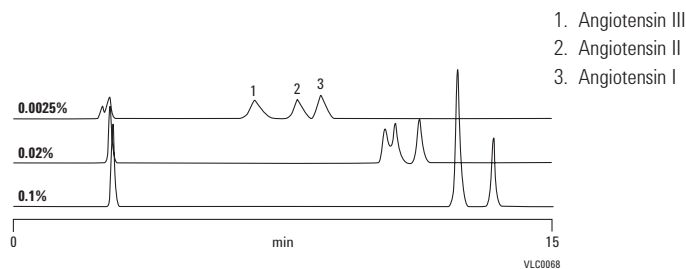

Exploiting chemical stability – NH₄OH concentration

Column: PLRP-S 100Å
PL1512-5500
4.6 x 250 mm, 5 μm

Mobile Phase: A: NH₄OH (various mM) in water
B: NH₄OH (various mM) in ACN

Gradient: Linear 10-100% B in 15 min

Flow Rate: 1.0 mL/min

Detector: ELS (neb=80 °C, evap=85 °C, gas=1.0 SLM)

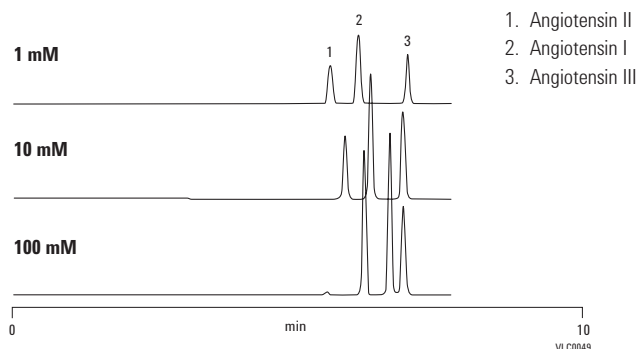

Alberta Peptide Institute test mix

Column: PLRP-S 100Å
PL1512-5500
4.6 x 250 mm, 5 μm

Mobile Phase: A: 0.1% TFA in 99% water:1% ACN
B: 0.1% TFA in 70% water:30% ACN

Gradient: 0-100% B in 30 min

Flow Rate: 1.0 mL/min

Detector: UV, 220 nm

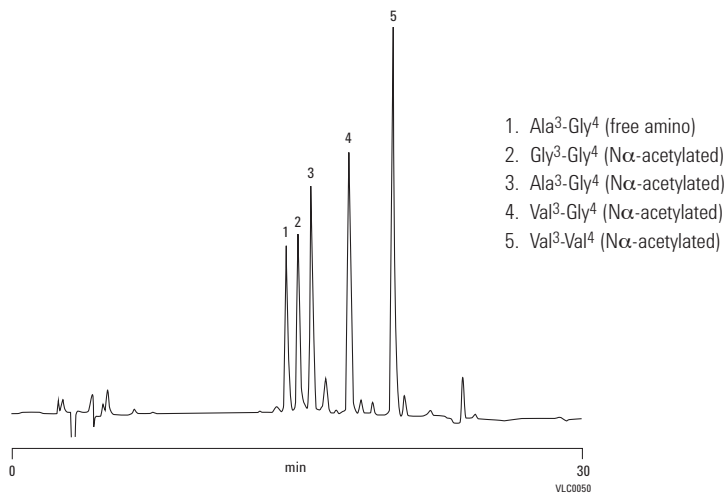

Whey proteins in dairy samples – milk

Column: PLRP-S 300Å
PL1512-3801
4.6 x 150 mm, 8 µm

Mobile Phase: A: 0.1% TFA in 99% water:1% ACN
B: 0.1% TFA in 1% water:99% ACN

Gradient: 36-48% B, 0-24 min, 48-100% B, 24-30 min
100% B, 30-35 min, 100-36% B, 35-40 min

Flow Rate: 1.0 mL/min

Injection Volume: 10 µL

Detector: UV, 220 nm

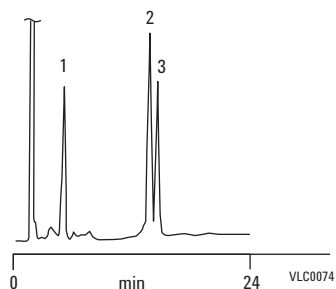

1. α-Lactalbumin
2. β-Lactoglobulin (B chain)
3. β-Lactoglobulin (A chain)

Temperature as a tool to enhance mass transfer and improve resolution of oligonucleotides in ion-pair reversed-phase HPLC

Column: PLRP-S 100Å
PL1512-1300
4.6 x 50 mm, 3 µm

Mobile Phase: A: 100 mM TEAA
B: 100 mM TEAA in 25% ACN

Gradient: 5% change in buffer B over 5 min

Flow Rate: 1.0 mL/min

Temperature: 35 °C, 60 °C, or 80 °C

Detector: UV, 254 nm

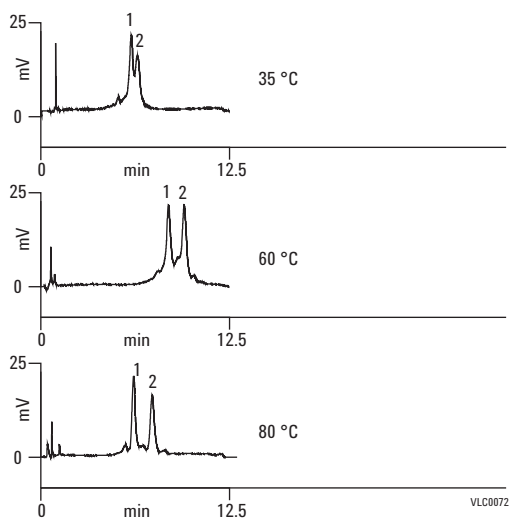

1. 29-mer
2. 30-mer

Large fibrous proteins

Column: PLRP-S 300Å
 PL1512-3801
 4.6 x 150 mm, 8 µm

Column: PLRP-S 1000Å
 PL1512-3802
 4.6 x 150 mm, 8 µm

Mobile Phase: A: 0.25% TFA in water
 B: 0.25% TFA in 5% water:95% ACN

Flow Rate: 1.0 mL/min



Gradient: 20-60% B in 15 min

Detector: UV, 220 nm

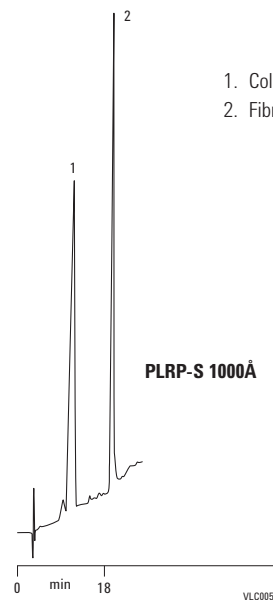
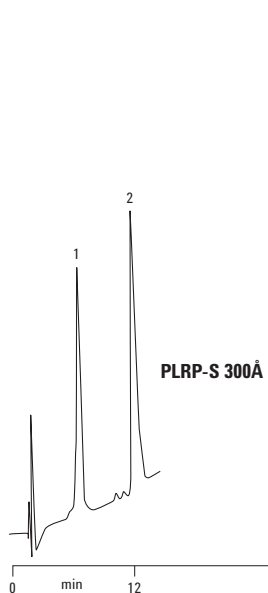
- 1. Collagen (120,000 MW)
- 2. Fibrinogen (340,000 MW)



PLRP-S HPLC Columns

Hardware	Size (mm)	Particle Size (µm)	PLRP-S 100Å USP L21	PLRP-S 300Å USP L21	PLRP-S 1000Å USP L21	PLRP-S 4000Å USP L21
	4.6 x 250	8	PL1512-5800	PL1512-5801	PL1512-5802	
	4.6 x 150	8	PL1512-3800	PL1512-3801	PL1512-3802	PL1512-3803
	4.6 x 50	8		PL1512-1801	PL1512-1802	PL1512-1803
	4.6 x 250	5	PL1512-5500	PL1512-5501		
	4.6 x 150	5	PL1111-3500	PL1512-3501		
	4.6 x 50	5	PL1512-1500	PL1512-1501	PL1512-1502	PL1512-1503
	4.6 x 150	3	PL1512-3300	PL1512-3301		
	4.6 x 50	3	PL1512-1300	PL1512-1301		
	2.1 x 250	8		PL1912-5801		
	2.1 x 150	8		PL1912-3801	PL1912-3802	PL1912-3803
	2.1 x 50	8		PL1912-1801	PL1912-1802	PL1912-1803
	2.1 x 250	5	PL1912-5500	PL1912-5501		
	2.1 x 150	5	PL1912-3500	PL1912-3501		
	2.1 x 50	5	PL1912-1500	PL1912-1501	PL1912-1502	PL1912-1503
	2.1 x 150	3	PL1912-3300	PL1912-3301		
	2.1 x 50	3	PL1912-1300	PL1912-1301		
	1.0 x 50	8			PL1312-1802	
	1.0 x 50	5	PL1312-1500		PL1312-1502	
	1.0 x 10	5			PL1C12-2502	
	1.0 x 150	3	PL1312-3300			
	1.0 x 50	3	PL1312-1300			
	PLRP-S Guard Cartridges for 5 x 3 mm, 2/pk		PL1612-1801	PL1612-1801	PL1612-1801	PL1612-1801
	Guard Cartridge holder for 3.0 x 5.0 mm cartridges		PL1310-0016	PL1310-0016	PL1310-0016	PL1310-0016

TIPS & TOOLS

For microbore columns ordering information, turn to page 143.

For prep columns and media ordering information, turn to page 157.

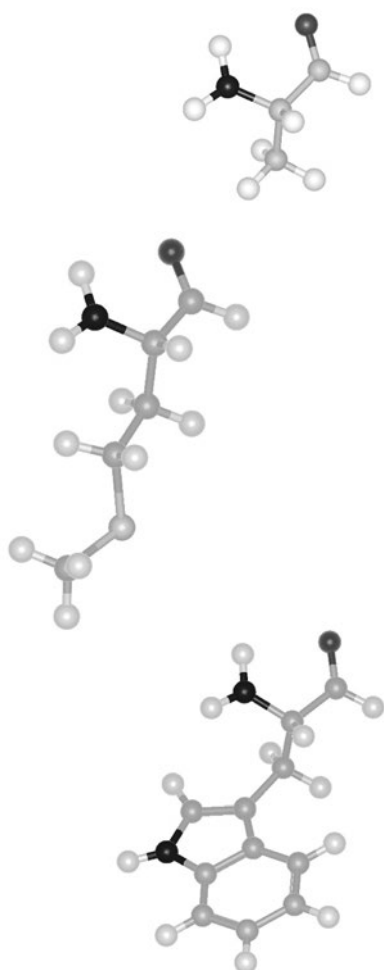

Amino Acid Analysis (AAA) Columns and Supplies

ZORBAX Eclipse Amino Acid Analysis (AAA) Columns

- Tested for amino acid analysis
- Uses well-known OPA and FMOC precolumn derivatization chemistry
- Easily automated using a detailed online, derivatization protocol available for use with Agilent 1100/1200 Infinity Series

The Agilent ZORBAX Eclipse AAA column separates amino acids following an updated and improved protocol. Total analysis from injection-to-injection can be achieved in 14 min (9 min analysis time) on shorter, 75 mm length columns and 24 min (18 min analysis time) on the 150 mm column length. Sensitivity (5-50 pmol with DAD, FLD) and reliability are achieved using both OPA and FMOC derivatization chemistries in one fully automated procedure using the Agilent 1100/1200 Infinity Series.

For high speed amino acid analysis on UHPLC systems, ZORBAX Eclipse Plus C18 1.8 μm columns give excellent results.

ZORBAX Eclipse Amino Acid Analysis (AAA) Columns

Hardware	Description	Size (mm)	Particle Size (μm)	Part No.
	Analytical routine sensitivity	4.6 x 150	5	993400-902
	Analytical routine sensitivity, high resolution using FLD	4.6 x 150	3.5	963400-902
	Analytical routine sensitivity, high throughput	4.6 x 75	3.5	966400-902
	Solvent Saver high sensitivity, high resolution	3.0 x 150	3.5	961400-302
	Guard Cartridges, 4/pk	4.6 x 12.5	5	820950-931
	Guard Hardware Kit			820999-901

TIPS & TOOLS

Further information can be found in:

Automatic Precolumn Derivatization of Amino Acids and Analysis by Fast LC using the Agilent 1290 Infinity LC System (publication 5990-5599EN)

www.agilent.com/chem/library

ZORBAX Eclipse Plus

Description	Size (mm)	Particle Size (μm)	Eclipse Plus C18 USP L1
Narrow Bore RRHD, 1200 bar	2.1 x 50	1.8	959757-902
Narrow Bore RRHT, 600 bar	2.1 x 50	1.8	959741-902

Amino Acid Standards

Each amino acid standard contains the following amino acids:

- Glycine
- L-cysteine
- L-histidine
- L-tyrosine
- L-leucine
- L-methionine
- L-serine
- L-alanine
- L-phenylalanine
- L-glutamic acid
- L-proline
- L-isoleucine
- L-arginine
- L-threonine
- L-valine
- L-lysine
- L-aspartic acid

Amino Acid Standards, 10/ea*

Description	Part No.
1 nmol/μL	5061-3330
250 pmol/μL	5061-3331
100 pmol/μL	5061-3332
25 pmol/μL	5061-3333
10 pmol/μL	5061-3334
Amino acids supplement kit Includes 1 g each of norvaline, sarcosine, asparagine, glutamine, tryptophan, and 4-hydroxyproline	5062-2478

*Consider shelf-life and buy limited quantities, p/n 5062-2478 ships as 1 g vials

Amino Acid Separations Reagents

Description	Part No.
OPA reagent, 10 mg/mL each in 0.4 M borate buffer o-phthalaldehyde (OPA) and 3-mercaptopropionic acid, 6/ea	5061-3335
FMOC reagent, 2.5 mg/mL in acetonitrile, 9-fluorenylmethylchloroformate, 1 mL, 10 ampoules	5061-3337
Borate buffer, 100 mL	5061-3339
DTDPA (dithiodipropionic) reagent, for analysis of cysteine, 5 g	5062-2479

High resolution of 24 amino acids

Column: ZORBAX Eclipse AAA
963400-902
4.6 x 150 mm, 3.5 µm

Mobile Phase: A: 40 mM Na₂HPO₄, pH 7.8
B: ACN:MeOH:water,
45:45:10 v/v

Flow Rate: 2 mL/min

Temperature: 40 °C

Detector: Fluorescence

Sample: 24 amino acids

- | | |
|---------|---------|
| 1. Asp | 13. Cys |
| 2. Glu | 14. Val |
| 3. Asn | 15. Met |
| 4. Ser | 16. Nva |
| 5. Gln | 17. Trp |
| 6. His | 18. Phe |
| 7. Gly | 19. Ile |
| 8. Thr | 20. Leu |
| 9. Cit | 21. Lys |
| 10. Arg | 22. Hyp |
| 11. Ala | 23. Sar |
| 12. Tyr | 24. Pro |

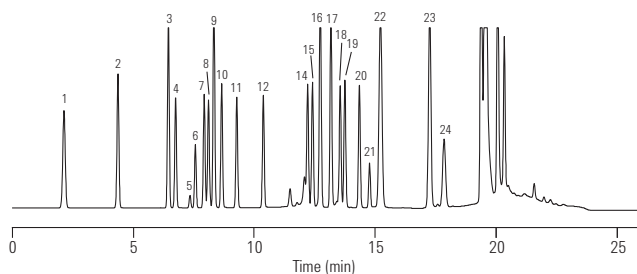

LCPAH01

This high resolution separation of 24 amino acids is achieved in 18 minutes. If the Rapid Resolution 4.6 x 75 mm Eclipse AAA column is selected, these amino acids are resolved in 9 minutes.

TIPS & TOOLS

Quick Reference Guides list the common supplies you should have on hand to keep your Agilent 1200 Infinity Series operating at peak efficiency. Download your free copy at www.agilent.com/chem/getguides

CHARGE VARIANT ANALYSIS

Purify proteins and other charged molecules

Ion-exchange chromatography (IEX) is a highly sensitive technique that allows you to separate ions and polar molecules based on their charge. Like SEC, IEX can be used to separate proteins in their native state.

Applying IEX to charge variant analysis

During production and purification, antibodies can exhibit changes in charge heterogeneity as a result of amino acid substitutions, glycosylation, phosphorylation, and other post-translational or chemical modifications. Because these changes can impact stability and activity – or cause immunologically adverse reactions – the analysis of charge heterogeneity in monoclonal antibody (mAb) preparations is critical to biopharmaceutical manufacture.

In protein analysis, charge variations at a given pH indicate a change in the primary molecular structure – resulting in additional forms of the protein in question. These are called isoforms (or charge variants), and can be resolved by IEX chromatography. IEX is also useful as a preparative technique.

Because these changes can impact stability and activity – or cause immunologically adverse reactions – the analysis of charge variants is critical to biopharmaceuticals.

As a leading supplier to the biopharmaceutical industry, Agilent understands that quality and consistency are critical to providing safe, highly efficacious therapeutics. Agilent ion-exchange BioHPLC columns offer the speed, resolution, and reproducibility you need to quickly and cost-effectively get life-changing products into the hands of those who need them.



The pages that follow describe Agilent's family of weak and strong ion-exchangers – both anionic and cationic.

- **Agilent nonporous Bio IEX columns** are designed for high resolution, high efficiency, and high recovery separations.
- **Agilent Bio MAb columns** are optimized for separating charge isoforms of monoclonal antibodies.
- **Agilent porous IEX columns** (PL-SAX and PL-SCX) are chemically stable, and are available in two pore sizes, allowing you to separate peptides, oligonucleotides, and very large proteins.
- **Bio-Monolith IEX columns** are uniquely suited for separating antibodies, viruses, and DNA.
- **Buffer Advisor software** is an ideal solution for automated protein separation by ionic strength gradients.

TIPS & TOOLS

For more information about the Agilent Buffer Advisor Software, see publication 5991-3697EN

www.agilent.com/chem/library

Ion-Exchange Column Selection

Application	Agilent Columns	Notes
Monoclonal antibodies	Bio MAb	Thorough characterization of monoclonal antibodies includes the identification and monitoring of acidic and basic isoforms. Agilent Bio MAb HPLC columns feature a unique resin specifically designed for high resolution charge-based separations of monoclonal antibodies.
Peptides and proteins	Bio IEX	Agilent Bio IEX columns are packed with polymeric, nonporous, ion-exchange particles. The Bio IEX columns are designed for high resolution, high recovery, and highly efficient separations.
Proteins, peptides and deprotected synthetic oligonucleotides	PL-SAX • 1000Å • 4000Å	The strong anion-exchange functionality, covalently linked to a fully porous chemically stable polymer, extends the operating pH range. In addition, the anion-exchange capacity is independent of pH. For synthetic oligonucleotides, separations using denaturing conditions of temperature, organic solvent, and high pH are all possible. The 5 µm media deliver separations at high resolution while the 30 µm media are used for medium pressure liquid chromatography.
Globular proteins and peptides	PL-SAX 1000Å	
Very large biomolecules/high speed	PL-SAX 4000Å	
Small peptides to large proteins	PL-SCX • 1000Å • 4000Å	PL-SCX is a macroporous PS/DVB matrix with a very hydrophilic coating and strong cation-exchange functionality. This process is controlled to provide the optimum density of strong cation-exchange moieties for the analysis, separation, and purification of a wide range of biomolecules. The 5 µm media deliver separations at higher resolution while the 30 µm media are used for medium pressure liquid chromatography.
Globular proteins	PL-SCX 1000Å	
Very large biomolecules/high speed	PL-SCX 4000Å	
Antibodies (IgG, IgM), plasmid DNA, viruses, phages, and other macro biomolecules	Bio-Monolith • Bio-Monolith QA • Bio-Monolith DEAE • Bio-Monolith SO ₃	Strong cation-exchange, strong and weak anion-exchange phases. Bio-Monolith HPLC columns are compatible with preparative LC systems, including Agilent 1100 and 1200 Infinity Series.
Viruses, DNA, large proteins	Bio-Monolith QA	
Plasmid DNS, bacteriophages	Bio-Monolith DEAE	
Proteins, antibodies	Bio-Monolith SO ₃	



Agilent Bio MAb HPLC Columns

- A packing support composed of a rigid, spherical, highly cross-linked polystyrene divinylbenzene (PS/DVB) nonporous bead
- Particles grafted with a hydrophilic polymeric layer, virtually eliminating nonspecific binding of antibody proteins
- A different process is used to layer the weak cation-exchange phase to the particle giving it a higher density than the Agilent Bio WCX column particles
- Specifically designed for the separation of charge isoforms of monoclonal antibodies

Thorough characterization of monoclonal antibodies includes the identification and monitoring of acidic and basic isoforms. Agilent Bio MAb HPLC columns feature a unique resin specifically designed for high resolution, charge-based separations of monoclonal antibodies. These columns are compatible with aqueous solution buffers, acetonitrile/acetone/methanol, and water mixtures. Commonly used buffers are phosphate, tris, MES, and acetate.

Bio MAb columns are available in 1.7, 3, 5, and 10 μm sizes, providing higher resolution with smaller particles.

Column Specifications

Bonded Phase	ID	Particle Size	pH Stability	Operating Temperature Limit	Flow Rate
Weak cation-exchange (carboxylate)	2.1 and 4.6 mm	1.7, 3, 5, and 10 μm	2-12	80 °C	0.1-1.0 mL/min



TIPS & TOOLS

Are you looking to increase your throughput for charge variant analysis of monoclonal antibodies? If so, refer to:

Reducing Cycle Time for Charge Variant Analysis of Monoclonal Antibodies Alternating Column Regeneration Using an Agilent 1200 Infinity Series Quick-Change Bio-inert 2-position/10-port Valve (publication 5991-4722EN)

www.agilent.com/chem/library

Consistent ion-exchange mAb separation

Column: Bio MAb, PEEK
5190-2407
4.6 x 250 mm, 5 µm

Mobile Phase: A: Sodium phosphate 10 mM, pH 5.5
B: A + sodium chloride 0.5 M

Flow Rate: 0.85 mL/min

Gradient: 10 to 35% B from 0 to 25 min
(unless otherwise stated)

Detector: UV, 225 nm

Sample: 5 µg of 1 mg/mL of intact or C-terminal digested IgG1

Instrument: Agilent 1260 Infinity Bio-inert Quaternary LC or
Agilent 1100 Series LC

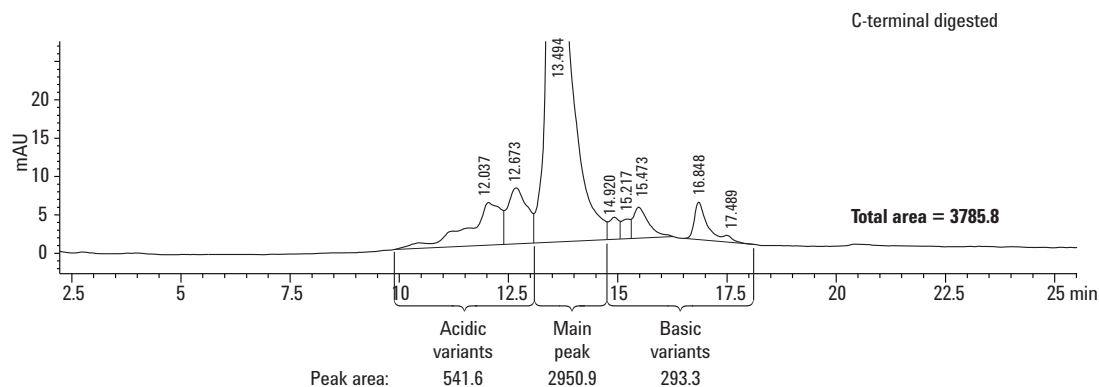
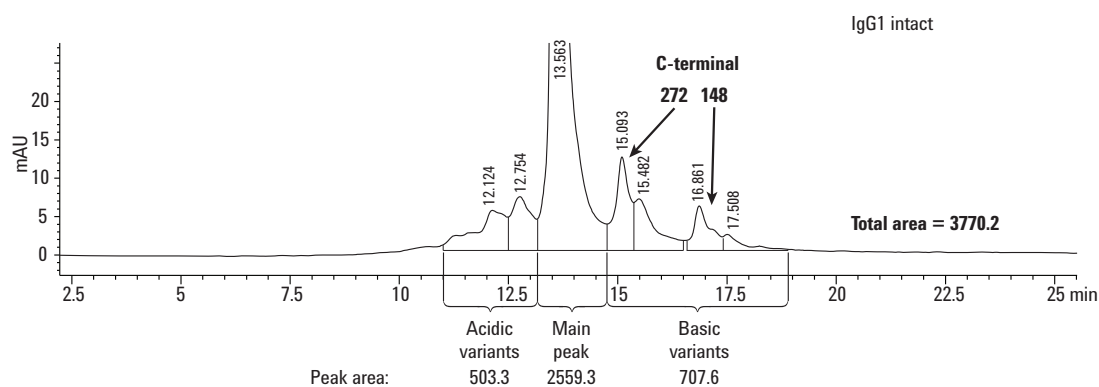

Calculation of C-terminal digested IgG1 using an Agilent Bio MAb 5 µm column on the Agilent 1260 Infinity Bio-inert Quaternary LC.

pH Gradients – a powerful alternative for charge variant analysis

Column: Bio MAb, PEEK
5190-2408
4.6 x 50 mm, 5 µm

Gradient: 6.5 to 7.5 (0-20 min), 50 mM

Sample: IgG monoclonal antibody

Analysis of a IgG monoclonal antibody

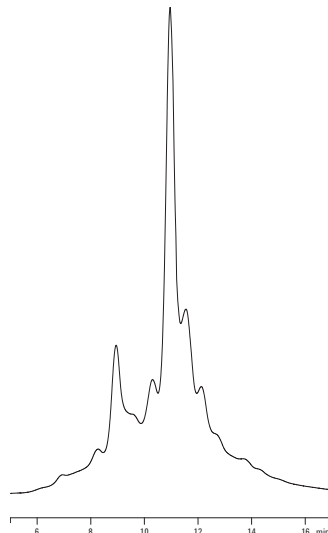

Reproducibility and precision – Bio MAb columns enable precise quantitation, robust methods

Column: Bio MAb, PEEK
5190-2407
4.6 x 250 mm, 5 µm

Mobile Phase: A: 10 mM Sodium phosphate buffer, pH 6.0
B: 10 mM Sodium bicarbonate buffer, pH 9.5

Flow Rate: 1.0 mL/min

Gradient: Time (min) %B

0	0
25	100
27	100
30	0

Injection Volume: 10 µL (needle with wash, flush port active for 7 s)

Data Acquisition: 214, and 280 nm

Acquisition Rate: 20 Hz

Flow Cell: 60 mm path

Column Temperature: 30 °C

Sample Thermostat: 50 °C

Posttime: 5 min

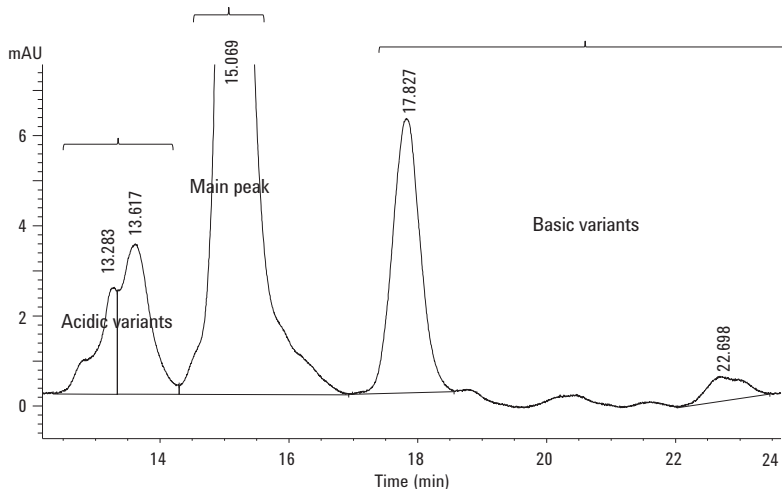

WCX separation of Fab and Fc fragments of Herceptin

Column: Bio MAb, PEEK
5190-2411
2.1 x 250 mm, 5 µm

Mobile Phase: A: 20 mM MES, pH 5.6
B: 20 mM MES, pH 5.6
+ 300 mM NaCl

Flow Rate: 170 µL/min

Injection Volume: 16 µL

Gradient:	Time (min)	%B
	0	2
	39.5	80
	40	100
	50	100
	50.5	2
	60	2

Temperature: 30 °C

Instrument: Agilent 1100 Series

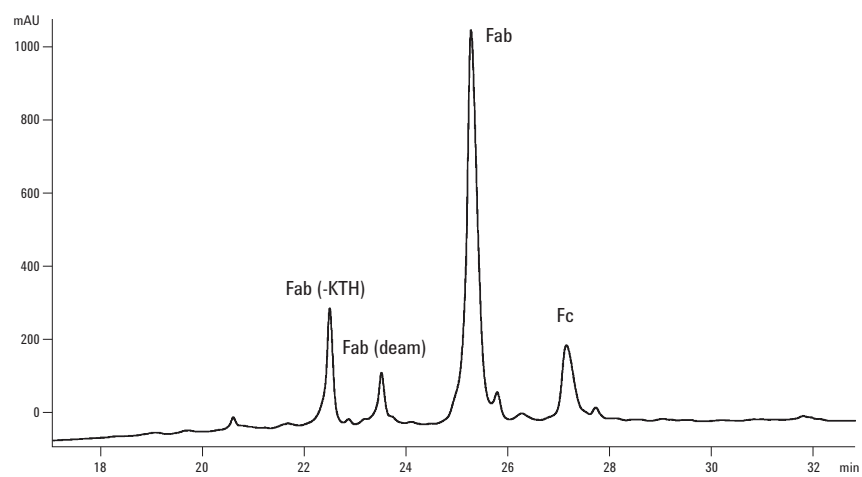

Method development using Buffer Advisor software – determination of optimum pH

Column: Bio MAb, PEEK
5190-2407
4.6 x 250 mm, 5 µm

Instrument: Agilent 1260 Infinity Bio-inert Quaternary LC

Buffer: A: H₂O
B: NaCl 3 M
C: MES (2-N-morpholino) ethanesulfonic acid monohydrate) 60 mM
D: MES-Na (2-(N-morpholino) ethanesulfonic acid sodium salt) 35 mM

Sample: Mix of three proteins, dissolved in PBS (phosphate buffered saline), pH 7.4

Ribonuclease A: 13,700 Da, pI 9.6
Cytochrome c: 12,384 Da, pI 10-10.5
Lysozyme: 14,307 Da, pI 11.35

Flow Rate: 1 mL/min

Gradient: 0 min – 20 mM NaCl
5 min – 20 mM NaCl
30 min – 500 mM NaCl
35 min – 1,000 mM NaCl
36 min – 20 mM NaCl

Injection Volume: 10 µL

Thermostat: 4 °C

Temperature TCC: 25 °C

DAD: 280 nm/4 nm
Ref.: OFF

Peak Width: >0.05 min (1.0 s response time)(5 Hz)

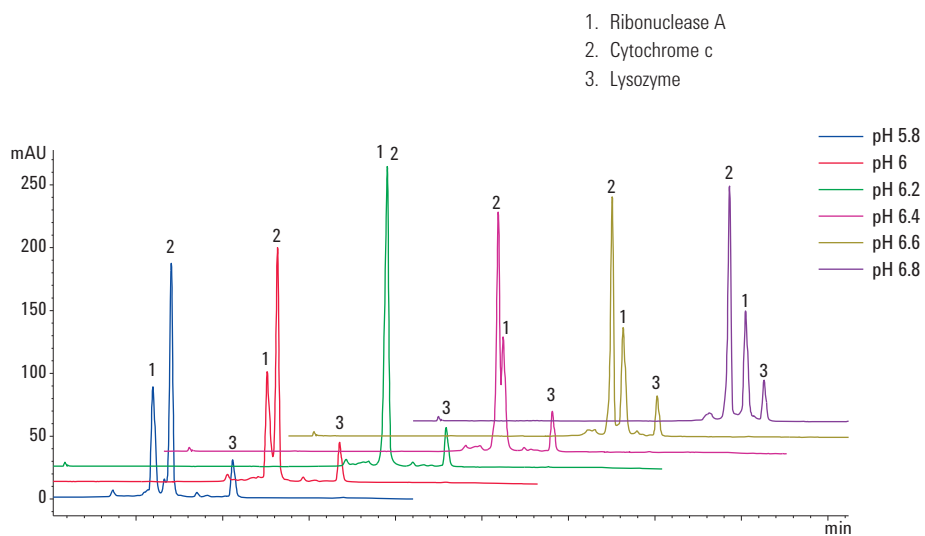

pH scouting for the separation of a three-protein mix using dynamically mixed quaternary gradients.

Virtually eliminate retention time variations

Column: Bio MAb, stainless steel
5190-2413
4.6 x 250 mm, 10 µm

Mobile Phase: A: 10 mM Sodium phosphate, pH 6.0
 B: A + 1.0 M Sodium chloride

Flow Rate: 1.0 mL/min

Gradient: 0-100% B in 42 min

Temperature: 25 °C

Detector: UV, 214 nm

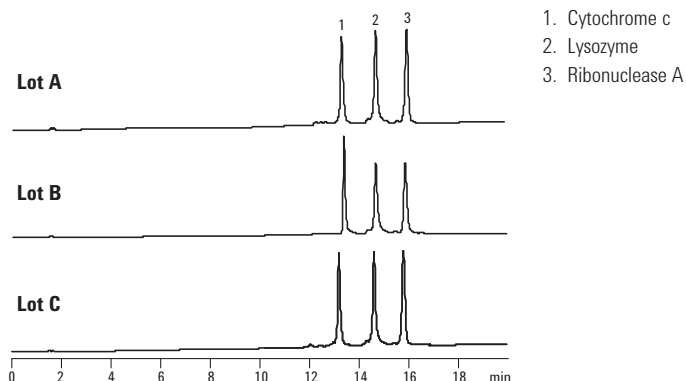

The combination of well-controlled resin production, column surface chemistry, and column packing virtually eliminates retention time variations from column-to-column and lot-to-lot.

Agilent Bio MAb HPLC Columns

Size (mm)	Particle Size (µm)	Bio MAb PEEK	Pressure Limit	Bio MAb Stainless Steel	Pressure Limit
21.2 x 250	5			5190-6885	275 bar, 4000 psi
10 x 250	5			5190-6884	275 bar, 4000 psi
4.6 x 250	10	5190-2415	275 bar, 4000 psi	5190-2413	275 bar, 4000 psi
4.6 x 50	10	5190-2416	275 bar, 4000 psi		
4.6 x 250	5	5190-2407	400 bar, 5800 psi	5190-2405	400 bar, 5800 psi
4.6 x 50	5	5190-2408	400 bar, 5800 psi		
4.6 x 50	3			5190-2403	551 bar, 8000 psi
4.6 x 50	1.7			5190-2401	600 bar, 8700 psi
4.0 x 10, Guard	10			5190-2414	275 bar, 4000 psi
4.0 x 10, Guard	5			5190-2406	413 bar, 6000 psi
4.0 x 10, Guard	3			5190-2404	551 bar, 8000 psi
4.0 x 10, Guard	1.7			5190-2402	600 bar, 8700 psi
2.1 x 250	10	5190-2419	275 bar, 4000 psi		
2.1 x 50	10	5190-2420	275 bar, 4000 psi		
2.1 x 250	5	5190-2411	400 bar, 5800 psi		
2.1 x 50	5	5190-2412	400 bar, 5800 psi		



Agilent Bio IEX HPLC Columns

- Highly cross-linked and rigid nonporous poly(styrene divinylbenzene) (PS/DVB) particles are grafted with a hydrophilic polymeric layer, eliminating nonspecific binding
- Uniform, densely packed ion-exchange functional groups are chemically bonded to the hydrophilic layer (multiple ion-exchange groups per anchor) to increase column capacity
- Particles, coating, and bonding are resistant to high pressures, promoting higher resolution and faster separations
- Multiple ion-exchange groups are captured on one anchor to increase capacity

Agilent Bio IEX HPLC columns are packed with polymeric, nonporous, ion-exchange particles and are designed for high resolution, high recovery and highly efficient separations of peptides, oligonucleotides, and proteins.

The Bio IEX family includes strong cation-exchange (SCX), weak cation-exchange (WCX), strong anion-exchange (SAX), and weak anion-exchange (WAX) phases. All phases are available in 1.7, 3, 5, and 10 μm nonporous particles.

Column Specifications

Bonded Phase	ID	Particle Size	pH Stability	Operating Temperature Limit	Flow Rate
SCX (strong cation-exchange) – SO_3H	2.1 and 4.6 mm	1.7, 3, 5, and 10 μm	2-12	80 °C	0.1-1.0 mL/min
WCX (weak cation-exchange) – COOH					
SAX (strong anion-exchange) – $\text{N}(\text{CH}_3)_3$					
WAX (weak anion-exchange) – $\text{N}(\text{C}_2\text{H}_5)_2$					

TIPS & TOOLS

For further information on optimizing your charged variant analysis, refer to:

Ion-exchange chromatography for biomolecule analysis: a "how-to" guide (publication 5991-3775EN), and

Agilent ion-exchange BioHPLC columns, characterize charged variants of proteins with speed and confidence (publication 5991-2449EN)

www.agilent.com/chem/library

Shortened and simplified charge variant workflow

Columns: Agilent Bio WCX, stainless steel
5190-2443
4.6 x 50 mm, 3 µm

Agilent Bio SCX, stainless steel
5190-2423
4.6 x 50 mm, 3 µm

Mobile Phase: A: Water
B: Sodium chloride 1.5 M
C: Monosodium phosphate 40 mM
D: Disodium phosphate 40 mM
By combining predetermined proportions of C and D as determined by the Buffer Advisor software, buffer solutions at the desired pH range and strength were created.

Flow Rate: 1.0 mL/min

Gradient: Conditions for chromatograms shown:
pH 5.0 to 7.0, 10 to 25 mM buffer strength
Sodium phosphate 0 to 500 mM, 0 to 15 min
Sodium phosphate 500 mM, 15 to 20 min
DOE experiments
pH 5.0 to 7.0
0 to 200 mM, 0 to 250 mM, and 0 to 300 mM

Temperature: Ambient

Detector: UV, 220 nm

Sample: IgG monoclonal antibody

Sample Conc: 2 mg/mL (in sodium phosphate buffer 20 mM, pH 6.0)

Instrument: Agilent 1260 Infinity Bio-inert Quaternary LC

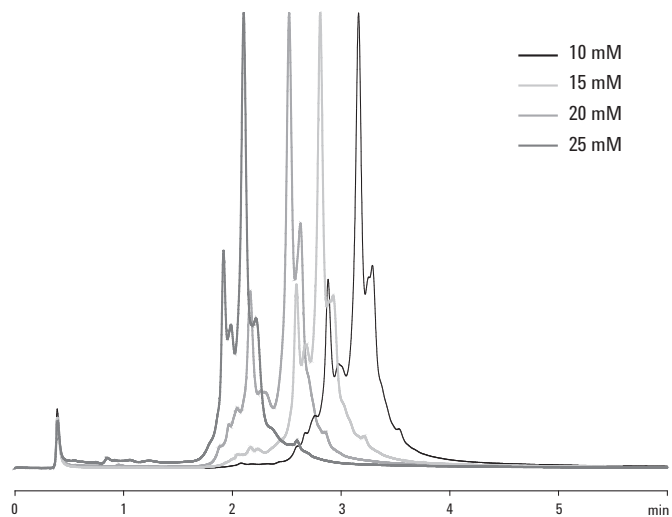

Automated method development for optimized charge variant separations. Optimizing buffer strength at pH 6.5 from the screening chromatograms of a monoclonal IgG separation.

Achieve faster analysis time with smaller particles and shorter column lengths – speed up your separation by 30%

Column: Agilent Bio WCX, stainless steel
5190-2445
4.6 x 250 mm, 5 µm

Column: Agilent Bio WCX, stainless steel
5190-2443
4.6 x 50 mm, 3 µm

Mobile Phase: A: Sodium phosphate 20 mM, pH 6.5
B: A + sodium chloride 1.6 M

Gradient: 0 to 50% B

Temperature: Ambient

Injection Volume: 10 µL

Detector: UV, 220 nm

Sample Conc: 0.5 mg/mL

Instrument: Agilent 1260 Infinity Bio-inert
Quaternary LC

1. Ovalbumin
2. Ribonuclease A
3. Cytochrome c
4. Lysozyme

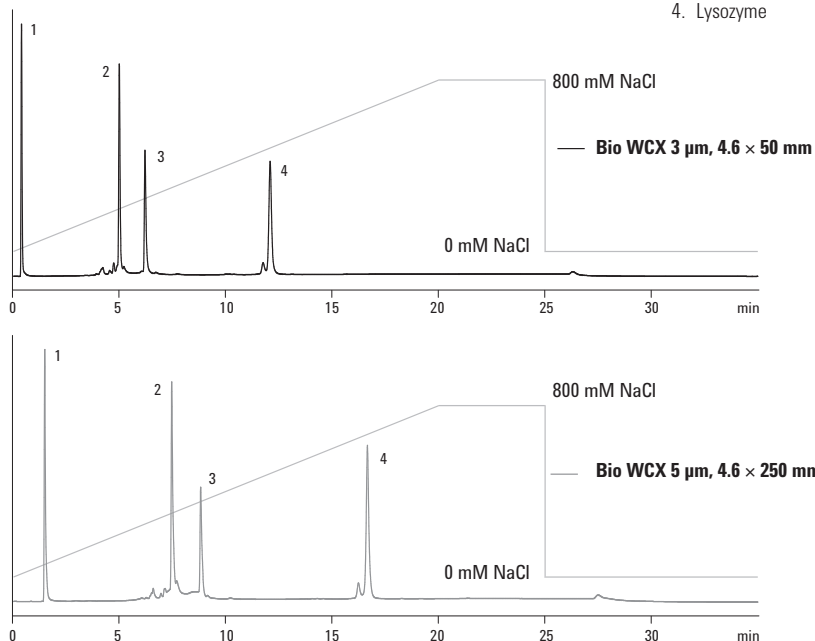

Protein separation on an Agilent Bio WCX 4.6 x 50 mm, 3 µm column vs. an Agilent Bio WCX 4.6 x 250 mm, 5 µm column (flow rate 1.0 mL/min). Faster analysis times were achieved through smaller particle size and shorter column length – samples eluted from the longer column in 17 min, and in just 12 min from the shorter column.

Smaller particle sizes provide increased resolution

Column: Agilent Bio WCX, stainless steel
5190-2443
4.6 x 50 mm, 3 μ m

Column: Agilent Bio WCX, stainless steel
5190-2441
4.6 x 50 mm, 1.7 μ m

Mobile Phase: A: Sodium phosphate 20 mM, pH 6.5
B: A + sodium chloride 1.6 M

Gradient: 0 to 50% B

Temperature: Ambient

Injection Volume: 10 μ L

Detector: UV, 220nm

Sample Conc: 0.5 mg/mL

Instrument: Agilent 1260 Infinity Bio-inert Quaternary LC

1. Ovabumin
2. Ribonuclease A
3. Cytochrome c
4. Lysozyme

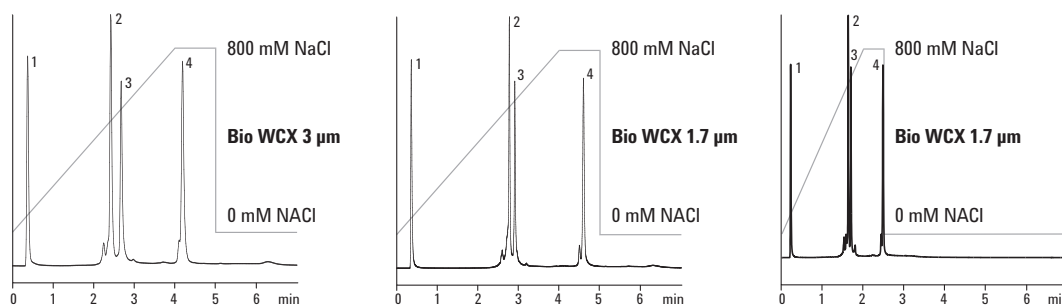

Left and middle: Protein separation on an Agilent Bio WCX 3 μ m column vs. an Agilent Bio WCX 1.7 μ m column (flow rate 1.0 mL/min).

Right: By increasing the flow rate to 1.7 mL/min, the separation time was reduced to less than 3 minutes. (An Agilent Bio WCX column was used).

Reduce analysis time – without sacrificing peak shape and resolution – by increasing flow rate.

Analysis of proteins by anion-exchange columns using the Agilent 1260 Infinity Bio-inert Quaternary LC System

Column: Agilent Bio WAX, PEEK
5190-2487
4.6 x 250 mm, 5 µm

Buffer: A: 20 mM tris, pH 7.6
B: 20 mM tris, pH 7.6 + 2 M NaCl,
1 M KCl, 1 M CH₃COONa,
1 M [(CH₃)₄N]Cl

Gradient 1 M: 5 min – 100% A
20 min – 70% B
25 min – 100% B

Gradient 2 M: 5 min – 100% A
20 min – 35% B
25 min – 50% B
25.01 min – 100% B

Stop Time: 30 min

Posttime: 20 min

Temperature: 25 °C

Flow Rate: 0.5 mL/min

Injection Volume: 5 µL

DAD: 280 nm

Peak Width: 0.025 min
(0.5 s response time)
(10 Hz)

For further information see application note
5990-9614EN (www.agilent.com/chem/library)

1. Myoglobin, pI 6.9
2. Conalbumin Isoform A, pI 6.24
3. Conalbumin Isoform B, pI 6.09
4. α-Lactalbumin, pI 4.5
5. Trypsin Inhibitor, pI 4.5

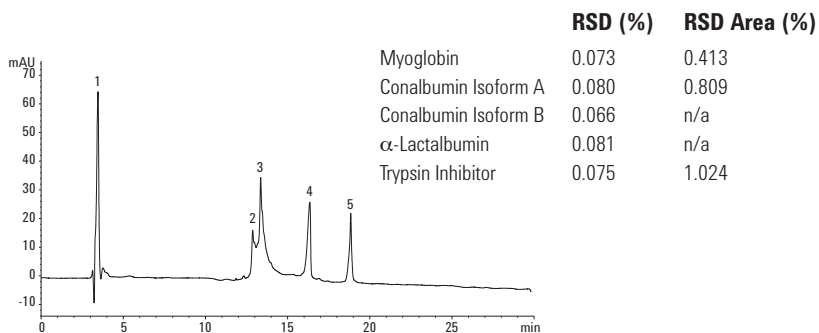

Figure 1. Protein separation by AEX by a linear gradient using 2 M NaCl as eluting salt.

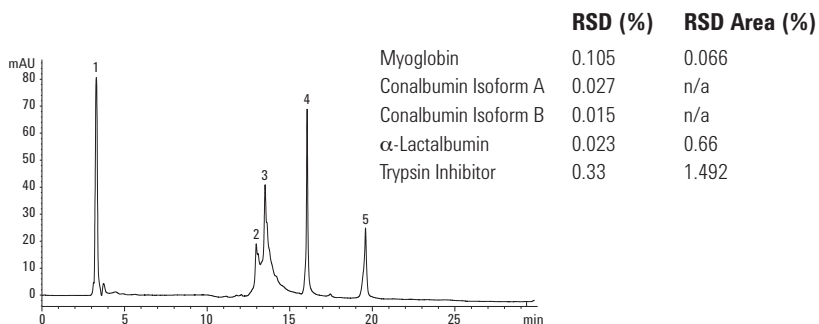

Figure 2. Protein separation by AEX by a linear gradient using 1 M KCl as eluting salt.

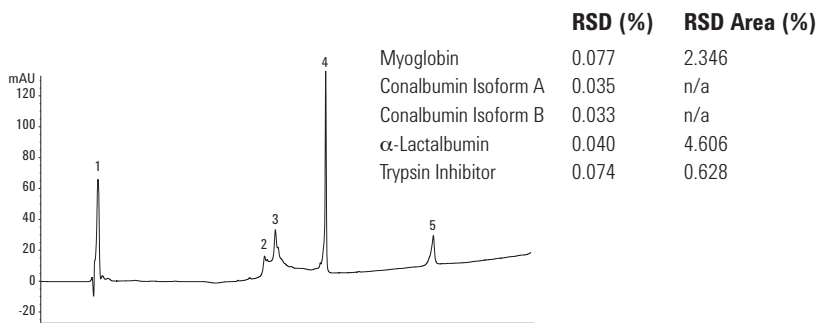

Figure 3. Protein separation by AEX by a linear gradient using 1 M [(CH₃)₄N]Cl as eluting salt.

Agilent Bio IEX HPLC Columns, PEEK

Size (mm)	Particle Size (µm)	Pressure Limit	Bio SCX Part No.	Bio WCX Part No.	Bio SAX Part No.	Bio WAX Part No.
4.6 x 250	10	275 bar, 4000 psi	5190-2435	5190-2455	5190-2475	5190-2495
4.6 x 50	10	275 bar, 4000 psi	5190-2436	5190-2456	5190-2476	5190-2496
4.6 x 250	5	400 bar, 5800 psi	5190-2427	5190-2447	5190-2467	5190-2487
4.6 x 50	5	400 bar, 5800 psi	5190-2428	5190-2448	5190-2468	5190-2488
2.1 x 250	10	275 bar, 4000 psi	5190-2439	5190-2459	5190-2479	5190-2499
2.1 x 50	10	275 bar, 4000 psi	5190-2440	5190-2460	5190-2480	5190-2500
2.1 x 250	5	400 bar, 5800 psi	5190-2431	5190-2451	5190-2471	5190-2491
2.1 x 50	5	400 bar, 5800 psi	5190-2432	5190-2452	5190-2472	5190-2492

Agilent Bio IEX HPLC Columns, Stainless Steel

Size (mm)	Particle Size (µm)	Pressure Limit	Bio SCX Part No.	Bio WCX Part No.	Bio SAX Part No.	Bio WAX Part No.
21.2 x 250	5		5190-6879	5190-6881	5190-6883	5190-6877
10 x 250	5		5190-6878	5190-6880	5190-6882	5190-6876
4.6 x 250	10	275 bar, 4000 psi	5190-2433	5190-2453	5190-2473	5190-2493
4.6 x 250	5	413 bar, 6000 psi	5190-2425	5190-2445	5190-2465	5190-2485
4.6 x 150	3					5190-6875
4.6 x 50	3	551 bar, 8000 psi	5190-2423	5190-2443	5190-2463	5190-2483
4.6 x 50	1.7	600 bar, 8700 psi	5190-2421	5190-2441	5190-2461	5190-2481
4.0 x 10, Guard	10	275 bar, 4000 psi	5190-2434	5190-2454	5190-2474	5190-2494
4.0 x 10, Guard	5	413 bar, 6000 psi	5190-2426	5190-2446	5190-2466	5190-2486
4.0 x 10, Guard	3	551 bar, 8000 psi	5190-2424	5190-2444	5190-2464	5190-2484
4.0 x 10, Guard	1.7	600 bar, 8700 psi	5190-2422	5190-2442	5190-2462	5190-2482

TIPS & TOOLS

For further information refer to:

Optimizing protein separations with Agilent weak cation-exchange columns (publication 5990-9628EN)

Faster separations using Agilent weak cation-exchange columns (publication 5990-9931EN)

pH Gradient elution for improved separation of monoclonal antibody variants (publication 5990-9629EN)

Optimizing protein separations with cation-exchange chromatography using Agilent Buffer Advisor (publication 5991-0565EN)

www.agilent.com/chem/library



PL-SAX Strong Anion-Exchange Columns

- Small particles deliver excellent chromatographic performance
- Wide range of particle sizes and two pore sizes for flexible analysis to scale up purification
- Exceptional stability for long column lifetime

PL-SAX $-N(CH_3)_3^+$ is ideal for the anion-exchange HPLC separations of proteins, peptides, and deprotected synthetic oligonucleotides under denaturing conditions. The strong anion-exchange functionality, covalently linked to a chemically stable fully porous polymer, extends the operating pH range. In addition, the anion-exchange capacity is independent of pH. For synthetic oligonucleotides, separations using denaturing conditions of temperature, organic solvent, and high pH are all possible. PL-SAX delivers improved chromatography for self-complementary or G-rich sequences that may associate to form aggregates or hairpin structures. The 5 μm material provides high efficiency separations of n and n-1 sequences. A wide range of particle sizes and column geometries permits analysis scale-up to purification. The strong anion-exchange functionality provides a material with exceptional chemical and thermal stability, even with sodium hydroxide eluents, leading to long column lifetime.

Column Specifications

Bonded Phase	ID (mm)	Particle Size (μm)	Pore Size	pH Stability	Operating Temperature Limit
Strong anion-exchange	2.1, 4.6, 7.5, 25, 50, and 100	5, 8, 10, and 30	1000Å and 4000Å	1-14	80 °C

Standard ion-exchange protein separation

Column: PL-SAX 1000Å
 PL1551-1502
 4.6 x 50 mm, 5 µm

Mobile Phase: A: 10 mM tris HCl, pH 8
 B: A + 350 mM sodium chloride, pH 8

Gradient: 0-100% B in 20 min

Flow Rate: 1.0 mL/min

Detector: UV, 220 nm

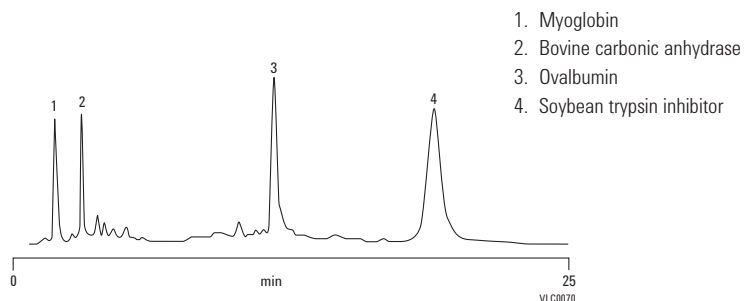
**Analysis of choline kinase**

Column: PL-SAX 4000Å
 PL1551-1803
 4.6 x 50 mm, 8 µm

Mobile Phase: A: 20 mM tris 5% ethylene glycol, pH 7.5
 (The following are required to retain enzyme activity)
 1.0 mM ethylene glycol tetraacetic acid
 2.0 mM β-mercaptoethanol
 0.2 mM phenylmethylsulfonyl fluoride
 B: A + 1 M potassium chloride

Flow Rate: 3.0 mL/min

Detector: UV, 280 nm

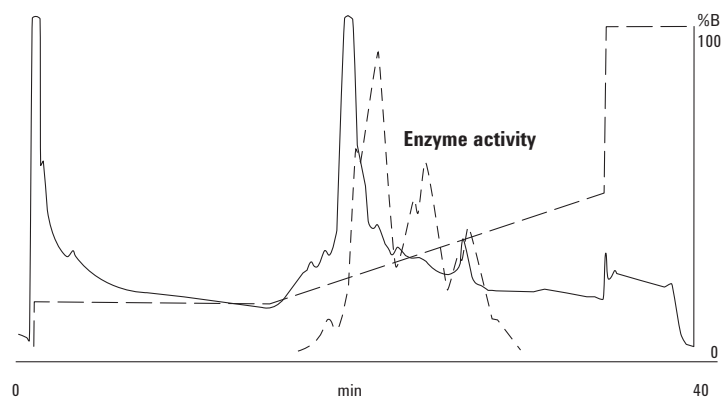

Separation courtesy of T Porter, Purdue University, USA

Analysis of representative whey proteins

Column: PL-SAX 1000Å
PL1551-1802
4.6 x 50 mm, 8 µm

Mobile Phase: A: 20 mM tris HCl, pH 7
B: A + 500 mM sodium acetate, pH 7

Flow Rate: 1.0 mL/min

Gradient: Linear 0-50% B in 10 min

Detector: UV, 280 nm

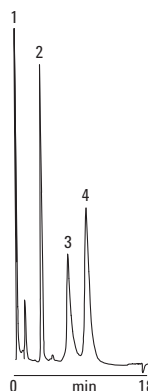

1. Carbonic anhydrase
2. α-Lactalbumin
3. β-Lactoglobulin B
4. β-Lactoglobulin A

Reliable separations of synthetic oligonucleotides – high resolution separation of a poly-t-oligonucleotide size standard spiked with 10-mer, 15-mer, 30-mer, and 50-mer (main peaks)

Column: PL-SAX 1000Å
PL1551-1802
4.6 x 50 mm, 8 µm

Mobile Phase: A: 7:93 v/v ACN: 100 mM TEAA, pH 8.5
B: 7:93 v/v ACN: 100 mM TEAA, 1 M ammonium chloride, pH 8.5

Gradient: 0-40% B in 10 min, followed by 40-70% B in 14 min and 70-100% B in 25 min

Flow Rate: 1.5 mL/min

Temperature: 60 °C

Detector: UV, 220 nm

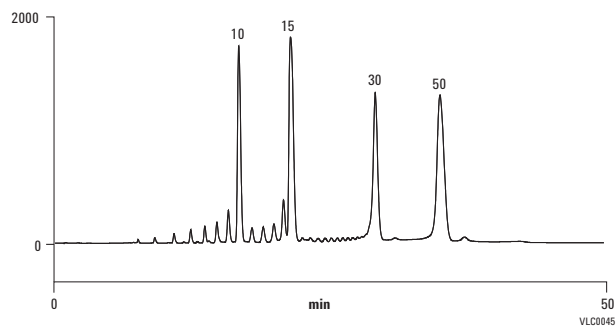

High resolution separation of poly-t-oligonucleotide. With the gradient used here, baseline separation of the n-1 from n was easily obtained up to the 15-mer.

PL-SAX Strong Anion-Exchange Columns

Size (mm)	Particle Size (μm)	Pressure Limit	PL-SAX 1000Å	PL-SAX 4000Å
100 x 300	10	207 bar, 3000 psi	PL1851-2102	PL1851-2103
50 x 150	30	207 bar, 3000 psi	PL1751-3702	PL1751-3703
50 x 150	10	207 bar, 3000 psi	PL1751-3102	PL1751-3103
25 x 150	30	207 bar, 3000 psi	PL1251-3702	PL1251-3703
25 x 150	10	207 bar, 3000 psi	PL1251-3102	PL1251-3103
25 x 50	10	207 bar, 3000 psi	PL1251-1102	PL1251-1103
4.6 x 250	30	207 bar, 3000 psi	PL1551-5702	PL1551-5703
4.6 x 150	30	207 bar, 3000 psi	PL1551-3702	PL1551-3703
4.6 x 250	10	207 bar, 3000 psi	PL1551-5102	PL1551-5103
4.6 x 150	10	207 bar, 3000 psi	PL1551-3102	PL1551-3103
4.6 x 150	8	207 bar, 3000 psi	PL1551-3802	PL1551-3803
4.6 x 50	8	207 bar, 3000 psi	PL1551-1802	PL1551-1803
4.6 x 50	5	207 bar, 3000 psi	PL1551-1502	PL1551-1503
2.1 x 150	8	207 bar, 3000 psi	PL1951-3802	PL1951-3803
2.1 x 50	8	207 bar, 3000 psi	PL1951-1802	PL1951-1803
2.1 x 50	5	207 bar, 3000 psi	PL1951-1502	PL1951-1503
1.0 x 50	5	207 bar, 3000 psi	PL1351-1502	PL1351-1503

PL-SAX Strong Anion-Exchange Bulk Media

Size	Particle Size (μm)	PL-SAX 1000Å	PL-SAX 4000Å
100 g	30	PL1451-4702	PL1451-4703
100 g	10	PL1451-4102	PL1451-4103



PL-SCX Strong Cation-Exchange Columns

- Optimal design for effective separation of biomolecules
- Pore sizes allow use of a range of solute sizes
- Exceptional stability for long column lifetime

PL-SCX $-SO_3^-$ is a macroporous PS/DVB matrix with a very hydrophilic coating and strong cation-exchange functionality. This process is controlled to provide the optimum density of strong cation-exchange moieties for the analysis, separation, and purification of a wide range of biomolecules, from small peptides to large proteins. Two pore sizes are available, 1000Å and 4000Å, to provide good mass-transfer characteristics for a range of solute sizes. The 5 µm media deliver separations at higher resolution with the 30 µm media used for medium pressure liquid chromatography.

Column Specifications

Bonded Phase	ID (mm)	Particle Size (µm)	Pore Size	pH Stability	Operating Temperature Limit
Strong cation-exchange	2.1, 4.6, 7.5, 25, 50, and 100	5, 8, 10, and 30	1000Å and 4000Å	1-14	80 °C

Standard protein separation

Column: PL-SCX 1000Å
PL1545-1502
4.6 x 50 mm, 5 µm

Mobile Phase: A: 20 mM potassium dihydrogen phosphate, pH 6.0
B: A + 1 M sodium chloride

Gradient: 0-100% B in 20 min

Flow Rate: 1.0 mL/min

Detector: UV, 280 nm

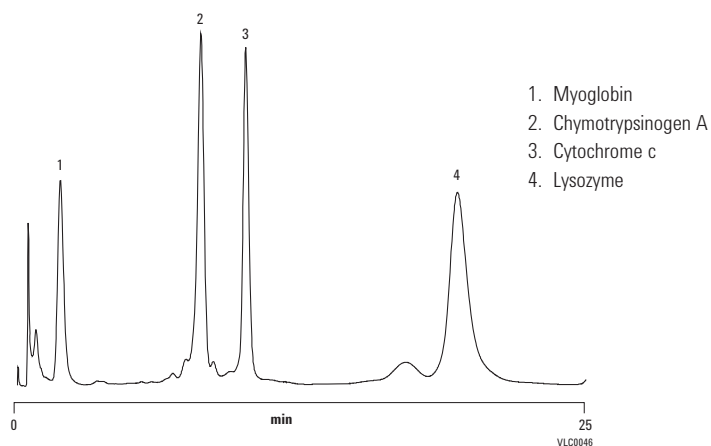

PL-SCX Strong Cation-Exchange Columns

Size (mm)	Particle Size (μm)	Pressure Limit	PL-SCX 1000Å	PL-SCX 4000Å
100 x 300	10	207 bar, 3000 psi	PL1845-2102	PL1845-2103
50 x 150	30	207 bar, 3000 psi	PL1745-3703	PL1745-3703
50 x 150	10	207 bar, 3000 psi	PL1745-3102	PL1745-3103
25 x 150	30	207 bar, 3000 psi	PL1245-3702	PL1245-3703
25 x 150	10	207 bar, 3000 psi	PL1245-3102	PL1245-3103
25 x 50	10	207 bar, 3000 psi	PL1245-1102	PL1245-1103
4.6 x 250	30	207 bar, 3000 psi	PL1545-5703	PL1545-5703
4.6 x 150	30	207 bar, 3000 psi	PL1545-3702	PL1545-3703
4.6 x 250	10	207 bar, 3000 psi	PL1545-5102	PL1545-5103
4.6 x 150	10	207 bar, 3000 psi	PL1545-3102	PL1545-3103
4.6 x 150	8	207 bar, 3000 psi	PL1545-3802	PL1545-3803
4.6 x 50	8	207 bar, 3000 psi	PL1545-1802	PL1545-1803
4.6 x 50	5	207 bar, 3000 psi	PL1545-1502	PL1545-1503
2.1 x 150	8	207 bar, 3000 psi	PL1945-3802	PL1945-3803
2.1 x 50	8	207 bar, 3000 psi	PL1945-1802	PL1945-1803
2.1 x 50	5	207 bar, 3000 psi	PL1945-1502	PL1945-1503
1.0 x 50	5	207 bar, 3000 psi	PL1345-1502	PL1345-1503

PL-SCX Strong Cation-Exchange Bulk Media

Size	Particle Size (μm)	PL-SCX 1000Å	PL-SCX 4000Å
100 g	30	PL1445-4702	PL1445-4703
100 g	10	PL1445-4102	PL1445-4102

TIPS & TOOLS

PL-SAX and PL-SCX columns and bulk media are also available for Prep to Process.
Turn to pages 161-163.



Bio-Monolith Ion-Exchange HPLC Column

Agilent Bio-Monolith Ion-Exchange HPLC Columns

- Polymer-based, monolith HPLC columns designed for macro biomolecule separations
- Flow-rate independent separations; no diffusion, no pores, and no void volume make transport between mobile and stationary phase very rapid
- Monolith disk is 5.2 x 4.95 mm (100 μ L column volume) with continuous channels, eliminating diffusion mass transfer
- Extremely fast separations speed up method development time and decrease costs; locking in method parameters takes significantly less time and buffer

Agilent Bio-Monolith Ion-Exchange HPLC columns provide high resolution and rapid separations of antibodies (IgG, IgM), plasmid DNA, viruses, phages, and other macro biomolecules. The product family offers strong cation-exchange, strong and weak anion-exchange, and Protein A phases. Bio-Monolith HPLC columns are compatible with HPLC and preparative LC systems, including Agilent 1100 and 1200 Infinity Series.

Agilent Bio-Monolith HPLC Column Selection Guide

Column	Description	Key Applications	Part No.
Bio-Monolith QA	The quaternary amine bonded phase (strong anion-exchange) is fully charged over a working pH range of 2-13, binding negatively charged biomolecules.	<ul style="list-style-type: none"> • Adenovirus process monitoring and quality control • IgM purification monitoring and quality control • Monitoring DNA impurity removal • Monitoring endotoxin removal • HSA purity 	5069-3635
Bio-Monolith DEAE	The diethylaminoethyl bonded phase (weak anion-exchange) offers increased selectivity of biomolecules with negative charge over a working pH range of 3-9.	<ul style="list-style-type: none"> • Process monitoring and quality control of bacteriophage manufacturing and purification • Process monitoring and quality control of plasmid DNA purification 	5069-3636
Bio-Monolith SO ₃	The sulfonyl bonded phase (strong cation-exchange) is fully charged over a working pH range of 2-13, binding positively charged biomolecules.	<ul style="list-style-type: none"> • Fast and high resolution analytical separations of large molecules such as proteins and antibodies • Hemoglobin A1c fast analytics 	5069-3637

Column Specifications	
Dimensions	5.2 mm x 4.95 mm
Column volume	100 μ L
Maximum pressure	150 bar (15 MPa, 2,200 psi)
Temperature min/max	Operating: 2-40 °C Storage: 2-8 °C
Recommended pH	Operating range: 2-13 Cleaning-in-place: 1-14
Materials of construction	Hardware: stainless steel Packing: poly(glycidyl methacrylate-co-ethylene dimethacrylate) highly porous monolith
Color ring identifier	Bio-Monolith QA: blue Bio-Monolith DEAE: green Bio-Monolith SO ₃ : red
Shelf life/expiration date	SO ₃ , QA, DEAE: 24-36 months

TIPS & TOOLS

Easily scale your method to a different particle size or different column dimensions with the Agilent Method Translation Tool. Calculate time and solvent savings too at www.agilent.com/chem/lcmethodtranslator

Baseline expansion of a separation of protein standards

Column: Agilent Bio-Monolith CM15, 5.5 x 15 mm

Mobile Phase: A: 10 mM sodium hydrogen phosphate, pH 6.0
B: A + 500 mM sodium chloride or just 500 mM sodium hydrogen phosphate, pH 6.0

Flow Rate: 2 mL/min

Gradient: 0.5 min hold with mobile phase A followed by a linear gradient to 45% B in 15 min (elapsed time 15.5 min), then 60% B at 15.6 min continued to 20 min. Column flushed with 100% B for 15 min before re-equilibration for the next run.
pH gradient: A: 5 mM sodium hydrogen phosphate, buffer, pH 5.5 and B: 40 mM sodium hydrogen phosphate (not buffered, pH 8.9). 2% B/min at 1 mL/min for 15 min, followed by a column wash with 90% B for 5 min.

Detector: UV, 220 nm

Sample: One mg each/mL in mobile phase A
1. RNase from bovine pancreas (pI 9.6)
2. Cytochrome c from bovine heart (pI 10.37-10.8)
3. Lysozyme from chicken egg (pI 11.35) (0.5 mg)

Instrument: Agilent 1200 Infinity Series with diode array detector

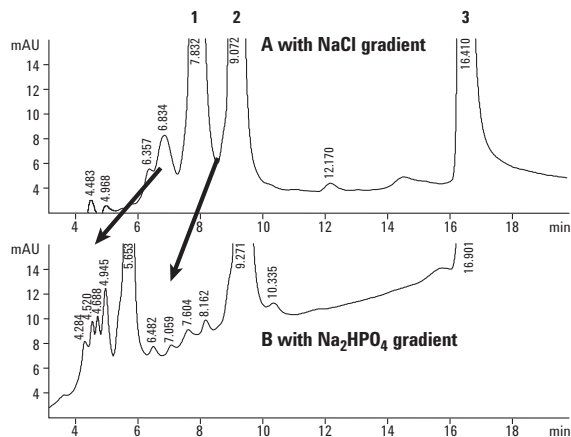

B shows a better resolution of protein contaminants.

Monitor phage production during fermentation

Column: Bio-Monolith DEAE
5069-3636
5.2 x 4.95 mm

Mobile Phase: A: 125 mM sodium phosphate buffer, pH 7.0
B: 125 mM sodium phosphate buffer
+ 1 M sodium chloride, pH 7.0

Flow Rate: 1 mL/min

Gradient: 100% buffer A (2.5 min)
0-100% buffer B (10 min)
100% buffer A (2 min)

Detector: UV, 280 nm

Instrument: High pressure gradient HPLC system,
Agilent 1200 Infinity Series

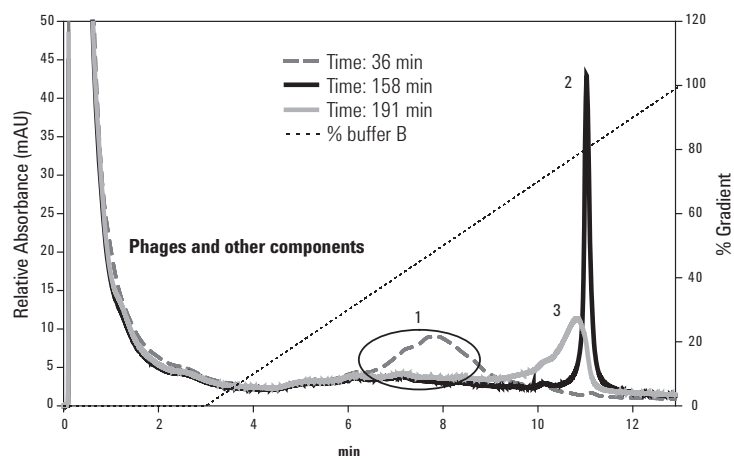

As phage proliferation progresses, the genomic DNA (gDNA) concentration increases as the host cells are lysed. In the late stages of fermentation, gDNA begins to degrade into fragments. These gDNA fragments cannot be easily removed by purification media, and so it is critical to stop the fermentation cycle prior to the degradation of the genomic DNA. The chromatogram above represents three samples taken from the bioreactor at 36, 158, and 191 minutes. Peak 1 represents phage, media, and host cells, peak 2 the intact gDNA, and peak 3 the fragmented gDNA.



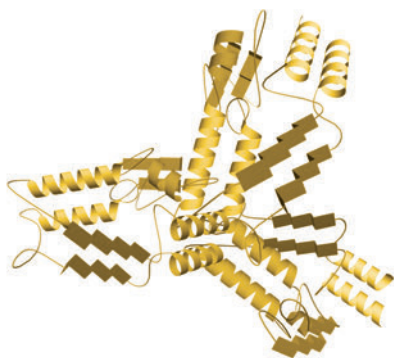

AGGREGATION AND FRAGMENT ANALYSIS

Accurately determine biomolecule aggregation, fragmentation, and chemical ligation/modification

Size exclusion chromatography (SEC) is a technique for separating proteins, oligonucleotides, and other complex biopolymers by size using aqueous eluents. In particular, it is an essential tool for quantification of aggregates present in protein biotherapeutics. Manufacture of a biopharmaceutical such as a monoclonal antibody is a complex process and aggregation of the protein is an issue that can arise during cell culture, isolation, purification, and formulation. The presence of dimers and higher aggregates can affect both efficacy and safety of the final product; quantification of aggregate content must be carried out during process development to establish the product's critical quality attributes (CQA) as well as during final product characterization to ensure the extent of aggregation is minimized and controlled at safe levels.

Applying SEC to aggregation studies

The size, type, and content of aggregates present in protein biopharmaceuticals can affect both efficacy and formulation – or worse, induce an immunogenic response. Aggregate formation occurs through a variety of mechanisms, including disulfide bond formation and noncovalent interactions.

Because the size of protein aggregates, including dimers, is sufficiently different from the protein monomer, you can separate the various forms using SEC. In fact, SEC with UV or light scattering is a standard technique for quantifying protein aggregation.

Applying SEC to quantitation and molecular weight determination

For proteins and other molecules of discrete molecular weight, SEC can be used to detect and quantitate monomers, dimers, aggregates, and fragments. SEC can also separate oligonucleotide mixtures.

For biopolymers containing varying chain lengths, such as starches and other polysaccharides, SEC can provide data on molecular weight distribution and branching (with the proper detectors).

As a leading manufacturer of SEC columns and instruments for over 30 years, Agilent is continually developing new SEC products that will provide even higher resolution and quicker separations. This section highlights Agilent's broad family of SEC columns for protein biopolymer analysis:

- Bio SEC-3 and Bio SEC-5 columns are available in a variety of pore sizes, and are well suited for protein analysis – especially when determining the presence of dimers and aggregates in therapeutic biologicals. Note that 3 μm Bio SEC-3 columns provide higher resolution than our industry-standard 5 μm Bio SEC-5 columns.
- ProSEC 300S columns work well with globular proteins under high salt conditions.
- ZORBAX GF-250 and GF-450 columns are legacy products that should be employed where protocols still require use of USP designation L35. Alternatively, we recommend using Bio SEC columns for improved performance.
- PL aquagel-OH columns can be used to analyze biopolymers of broad molecular weights, such as PEGs, oligo- and polysaccharides, starches, and gums. Please refer to aqueous and polar GPC/SEC columns product guide (publication 5990-7995EN).

Size Exclusion Chromatography (SEC)

Application	Agilent Columns	Notes	USP Designation
Peptides, proteins, aggregate analysis	Agilent Bio SEC-3	Higher resolution and faster separations from 3 μm particles, with 100Å, 150Å, and 300Å pore sizes.	L33 or L59
Large biomolecules and samples with multiple molecular weight components	Agilent Bio SEC-5	More pore size options (100Å, 150Å, 300Å, 500Å, 1000Å, and 2000Å) to cover a wider range of analytes.	L33 or L59
Globular proteins, antibodies	ProSEC 300S	Single column option for protein analysis in high salt conditions.	L33
Proteins, globular proteins	ZORBAX GF-250/450	Legacy products that should be employed where protocols still require use of USP designation L35.	L35

Which SEC column is right for your application?

Agilent's wide selection of SEC columns gives you the choices you need to perfect separations based on your analytes and method parameters. This chart gives you an overview of the pore size ranges that yield the best results for common molecule types. We recommend that you begin your method development with Agilent Bio SEC-3 and 5 columns.

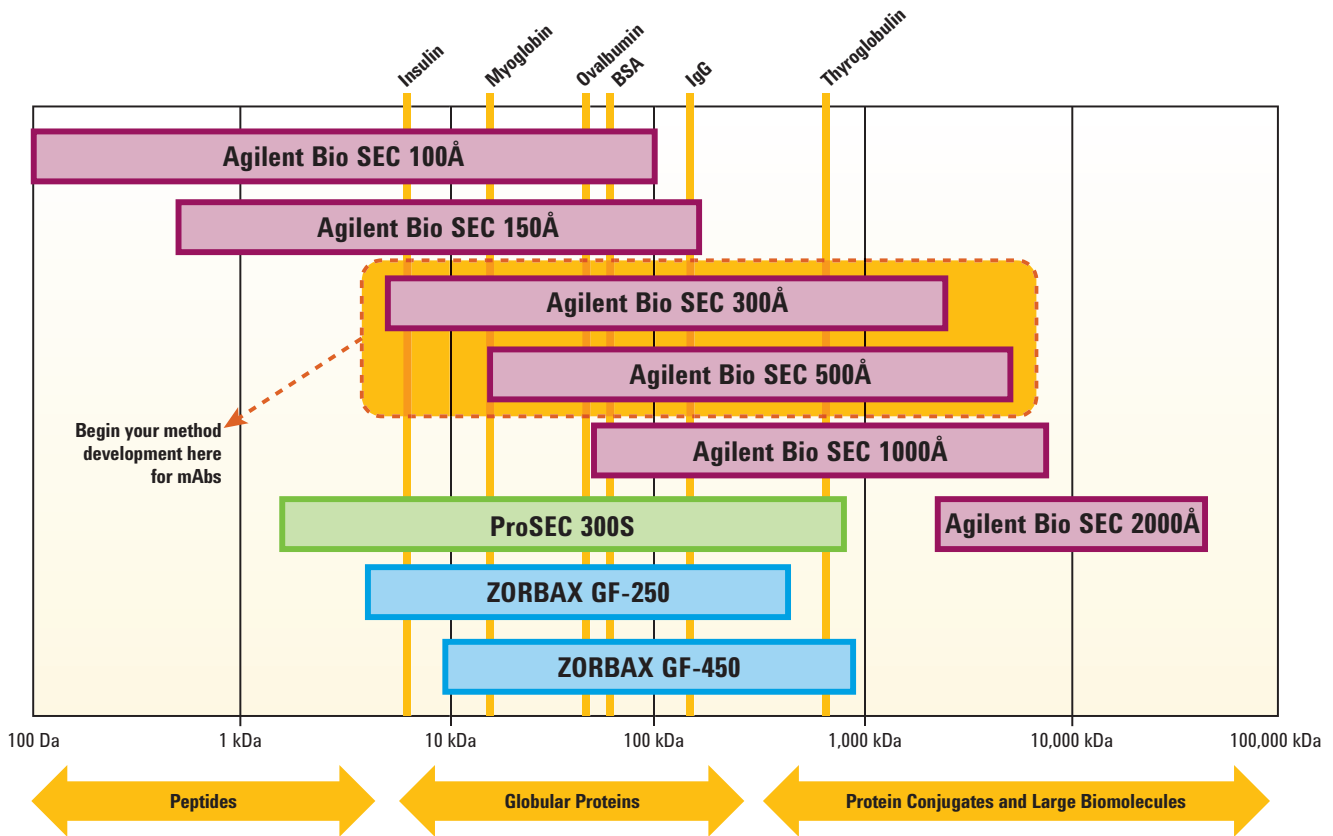



Agilent Bio SEC-3

Higher resolution for faster peptide and protein separations

Agilent Bio SEC-3 columns offer speed and resolution advantages over other SEC columns, thanks to their small, efficient particles.

- Faster separations than large-particle SEC columns
- High resolution: Sharper peaks and better protein recovery
- Exceptional loading capacity and recovery due to proprietary hydrophilic layer
- Flexible method development: Compatible with most aqueous buffers
- Excellent stability under both high- and low-salt conditions
- Reliable, consistent performance: Narrowly dispersed particles; proprietary hydrophilic layer provides for minimal secondary interactions
- Robust particles compatible with multi-detectors including light scattering

Bio SEC-3 columns help you achieve more consistent SEC separations. Each column is packed with spherical, narrowly dispersed 3 μm silica particles coated with a proprietary hydrophilic layer for high recovery and minimal secondary interactions, which provides more consistent separations. This thin polymeric layer is chemically bonded to pure, mechanically stable silica under controlled conditions, ensuring a highly efficient and stable size exclusion particle.

Column Specifications

Pore Size	Particle Size	MW Range	pH Range	Max Pressure	Flow Rate
100Å	3 μm	100-100,000	2-8.5	137 bar, 2000 psi	1.0-10.0 mL/min (21.2 mm id)
					0.2-1.2 mL/min (7.8 mm id)
					0.1-0.4 mL/min (4.6 mm id)
150Å	3 μm	500-150,000	2-8.5	137 bar, 2000 psi	1.0-10.0 mL/min (21.2 mm id)
					0.2-1.2 mL/min (7.8 mm id)
					0.1-0.4 mL/min (4.6 mm id)
300Å	3 μm	5,000-1,250,000	2-8.5	137 bar, 2000 psi	1.0-10.0 mL/min (21.2 mm id)
					0.2-1.2 mL/min (7.8 mm id)
					0.1-0.4 mL/min (4.6 mm id)

TIPS & TOOLS

Deactivated/silanized vials have inert surfaces that will not interact with metals, biologicals or proteins, and will not cause pH shifts. Avoid standard polypropylene vials for biological or light-sensitive compounds.

Calibration curves – Bio SEC-3

Column: Bio SEC-3
7.8 x 300 mm, 3 µm

Mobile Phase: Sodium phosphate 150 mM, pH 7.0

Flow Rate: 1.0 mL/min

Detector: UV

Proteins	MWt	300Å	150Å	100Å
Thyroglobulin	670,000	6.34	5.50	5.63
γ-Globulin	150,000	8.03	6.24	5.74
BSA	67,000	8.90	7.00	6.03
Ovalbumin	45,000	9.57	7.70	6.41
Myoglobin	17,000	10.12	8.50	7.10
Ribonuclease A	12,700	10.40	8.80	7.46
Vitamin B12	1,350	11.90	11.40	10.20

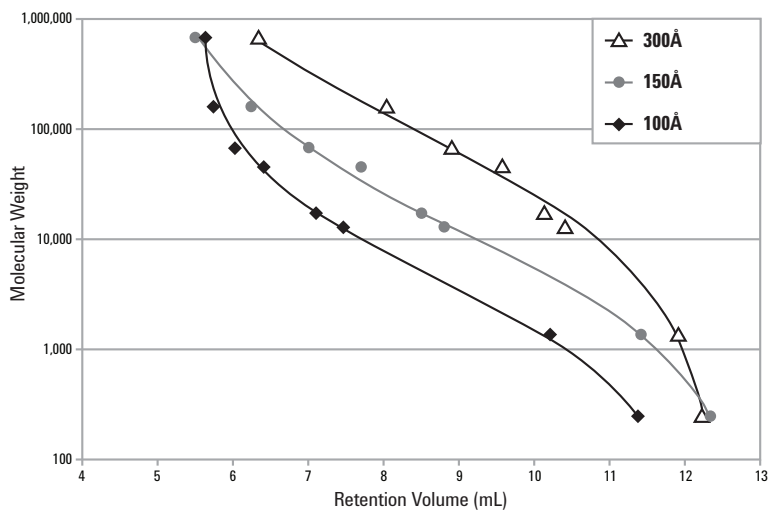

Intact mAb monomer and dimer separation

Column: Bio SEC-3, 300Å
5190-2511
7.8 x 300 mm, 3 µm

Buffer: Sodium phosphate 150 mM, pH 7.0

Flow Rate: 1.0 mL/min

Sample: CHO-humanized mAb, 5 mg/mL – intact

Injection: 5 µL

Detector: UV, 220 nm

Temperature: Ambient

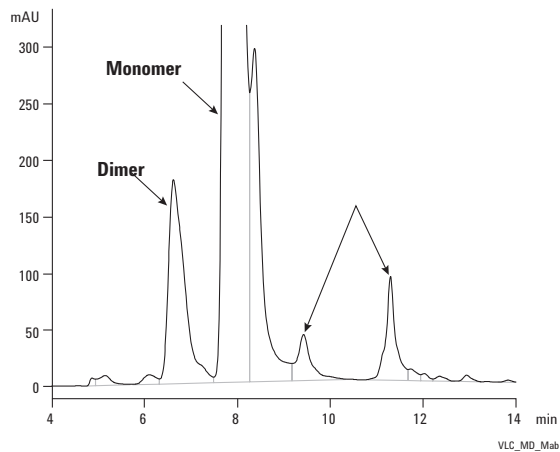

Comparison of Agilent Bio SEC-3 and competitor column in the analysis of a monoclonal antibody

Column: Bio SEC-3, 300Å
5190-2511
7.8 x 300 mm, 3 µm

Column: Competitor 7.8 x 300 mm

Mobile Phase: Sodium phosphate 150 mM + 100 mM sodium sulfate (with salt)
Sodium phosphate 150 mM (without salt)

Flow Rate: 1.0 mL/min

Detector: UV, 220 nm

Sample: mAb (2 mg/mL)

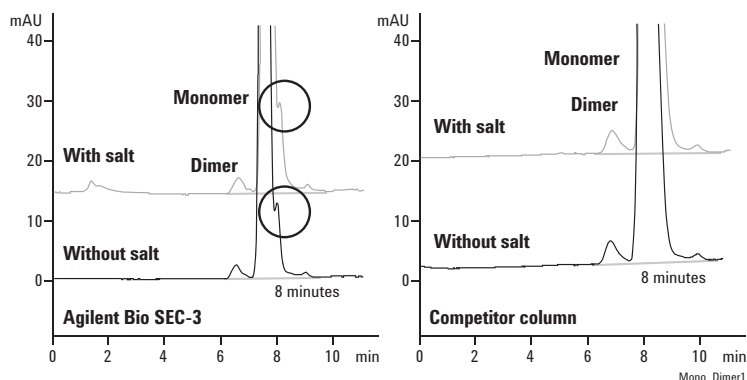

The Agilent Bio SEC-3 column reveals the presence of mAb fragments missed by the competitor column.

Monoclonal Antibody Monomer and Dimer Analysis using Agilent Bio SEC-3 and a Competitor Column

Eluent	Column	Resolution Ratio Monomer:Dimer	Monomer Efficiency	Percentage Dimer
With salt	Agilent	2.04	7,518	0.59
With salt	Competitor	1.88	3,967	0.59
Without salt	Agilent	2.08	7,942	0.60
Without salt	Competitor	1.92	4,164	0.57

TIPS & TOOLS

Further information can be found in:

Resolve Protein Aggregates and Degradants With Speed and Confidence
(publication 5991-2898EN)

www.agilent.com/chem/library

Pore Size Choice

The choice of media pore size will influence the resolution in SEC. As the separation is based on differences in molecular size in solution, the sample must be able to permeate the porous structure of the particles. If the pore size is too small, the samples will be excluded from the pores and elute in the void volume of the column, and if too large, then all will be able to fully permeate the particles and so there will be very little separation.

Pore size choice: proteins

Column A: Bio SEC-3, 100Å
5190-2503
4.6 x 300 mm, 3 µm

Column B: Bio SEC-3, 150Å
5190-2508
4.6 x 300 mm, 3 µm

Column C: Bio SEC-3, 300Å
5190-2513
4.6 x 300 mm, 3 µm

Mobile Phase: Sodium phosphate 100 mM
+ sodium chloride 150 mM, pH 6.8

Flow Rate: 0.35 mL/min

Detector: UV, 220 nm

Sample: Bio-Rad gel filtration standards mix

1. Thyroglobulin aggregates
2. Thyroglobulin
3. IgA
4. γ-Globulin
5. Ovalbumin
6. Myoglobin
7. Vitamin B12

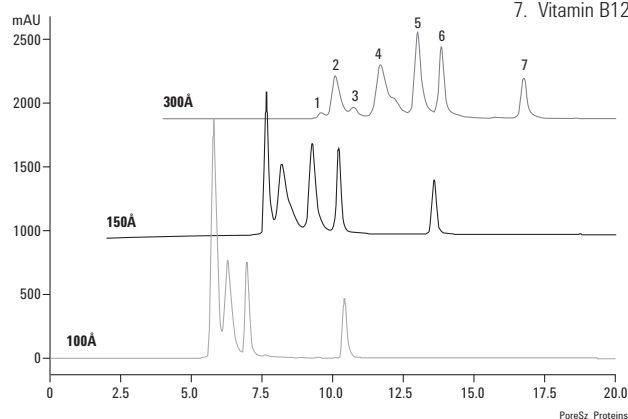

Pore size choice: mouse IgG

Column A: Bio SEC-3, 100Å
5190-2503
4.6 x 300 mm, 3 µm

Column B: Bio SEC-3, 150Å
5190-2508
4.6 x 300 mm, 3 µm

Column C: Bio SEC-3, 300Å
5190-2513
4.6 x 300 mm, 3 µm

Mobile Phase: Sodium phosphate 100 mM
+ sodium chloride 150 mM, pH 6.8

Flow Rate: 0.35 mL/min

Detector: UV, 220 nm

Sample: Mouse IgG

1. Dimer
2. Monomer
3. Monomer fragment
4. Azide

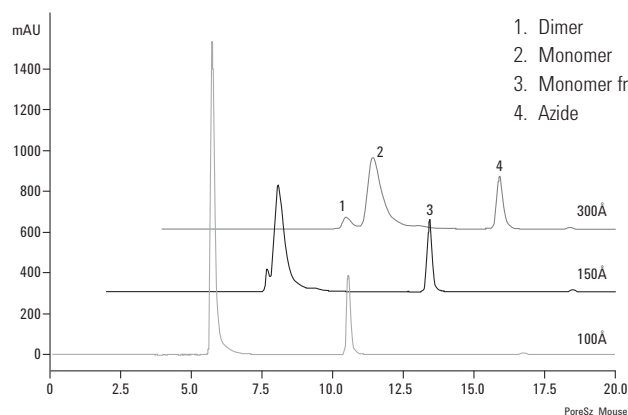

Column Length

Where the separation time is a critical parameter, shorter columns packed with the higher efficiency, 3 μm media are used. With the shorter columns, higher flow rates are used to reduce the analysis time but without compromising the quality of the data – quantitation of monoclonal antibody monomer and dimer.

Agilent Bio SEC-3 column length comparison, 150 mm

Column: Bio SEC-3, 300Å
5190-2512
7.8 x 150 mm, 3 μm

Mobile Phase: Sodium phosphate 150 mM

Flow Rate: 1.0 mL/min (56 bar), 1.5 mL/min (75 bar)

Detector: UV, 220 nm

Sample: mAb (2 mg/mL)

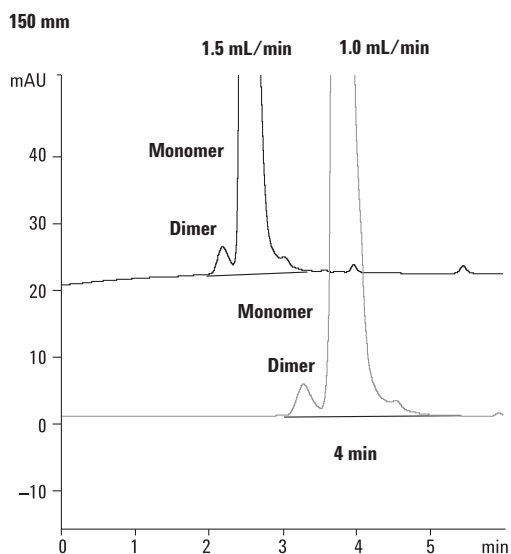

Agilent Bio SEC-3 column length comparison, 300 mm

Column: Bio SEC-3, 300Å
5190-2511
7.8 x 300 mm, 3 μm

Mobile Phase: Sodium phosphate 150 mM
+ sodium sulfate 100 mM (with salt)
Sodium phosphate 150 mM (without salt)

Flow Rate: 1.0 mL/min

Detector: UV, 220 nm

Sample: mAb (2 mg/mL)

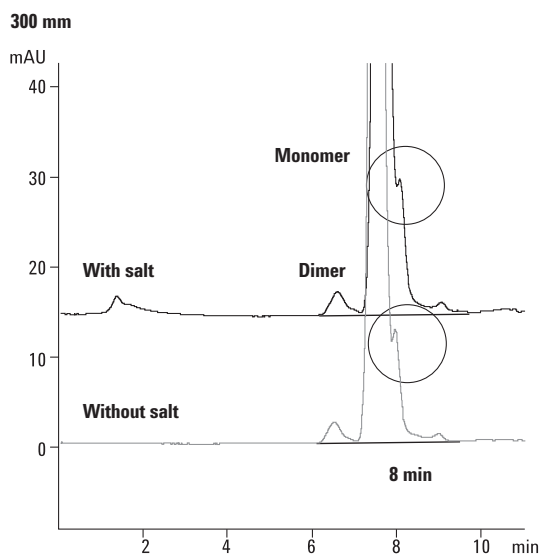

Agilent Bio SEC-3

Size (mm)	Particle Size (μm)	Bio SEC-3 100Å USP L33	Bio SEC-3 150Å USP L33	Bio SEC-3 300Å USP L33
21.2 x 300	3	5190-6850	5190-6851	5190-6852
21.2 x 50, Guard	3	5190-6854	5190-6855	5190-6856
7.8 x 300	3	5190-2501	5190-2506	5190-2511
7.8 x 150	3	5190-2502	5190-2507	5190-2512
7.8 x 50, Guard	3	5190-2505	5190-2510	5190-2515
4.6 x 300	3	5190-2503	5190-2508	5190-2513
4.6 x 150	3	5190-2504	5190-2509	5190-2514
4.6 x 50, Guard	3	5190-6846	5190-6847	5190-6848

Comparison of traditional SEC analysis

Column: Bio SEC-3, 300Å
 5190-2511
 7.8 x 300 mm, 3 μm

Mobile Phase: PBS, pH 7.4

Flow Rate: 0.75 mL/min

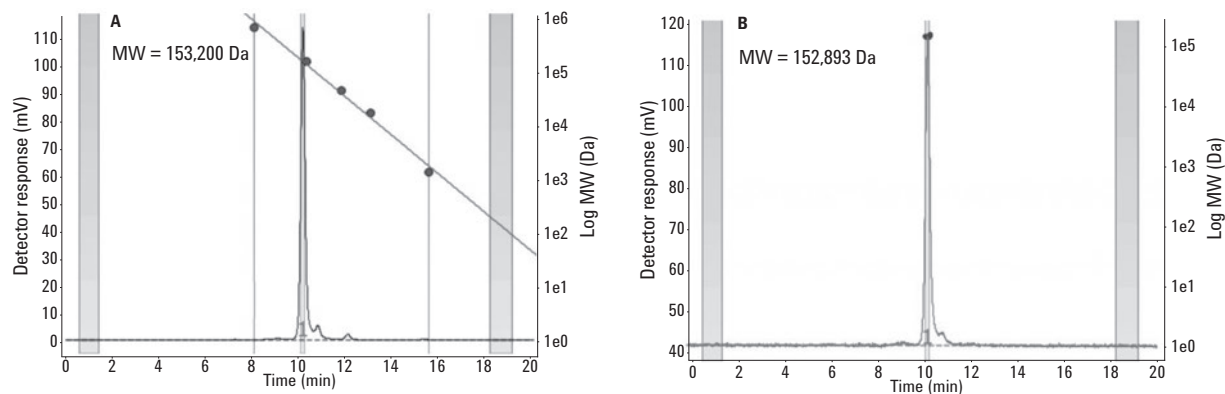

Comparison of traditional SEC analysis with UV detection and column calibration (A) and LS analysis at 90° (B) for anti-DYKDDDDK. Both MW results lie in the same range of approximately 153,000 Da.

TIPS & TOOLS

To further understand molecular weight determination and aggregation analysis using the Agilent 1260 Infinity Multi-Detector Bio-SEC Solution along with Agilent BioSEC-3 columns refer to:

Detailed Aggregation Characterization of Monoclonal Antibodies Using the Agilent 1260 Infinity Multi-Detector Bio-SEC Solution with Advanced Light Scattering Detection (publication 5991-3954EN), and *Determination of Protein Molecular Weight and Size Using the Agilent 1260 Infinity Multi-Detector Bio-SEC Solution with Advanced Light Scattering Detection* (publication 5991-3955EN)

www.agilent.com/chem/library



Agilent Bio SEC-5

- Exceptional resolution for large molecules
- High stability and efficiency due to a proprietary neutral hydrophilic layer
- Improved peak capacity and resolution due to specially designed packing that increases pore volume
- Rugged performance: Outstanding reproducibility and column lifetime
- Excellent stability, even under high-pH, high-salt, and low-salt conditions
- Flexible method development: Compatible with most aqueous buffers
- Broad applicability: Up to 2000Å pore size for vaccines and high molecular weight biomolecules

For large biomolecules and samples with components of multiple molecular weights, Agilent Bio SEC-5 columns are an ideal choice. They are packed with 5 µm silica particles coated with a proprietary, neutral, hydrophilic layer for maximum efficiency and stability, with six different pore sizes to provide optimum resolution over the molecular weight range.

Column Specifications

Pore Size	Particle Size	MW Range	pH Range	Max Pressure	Flow Rate
100Å	5 µm	100-100,000	2-8.5	137 bar, 2000 psi	1.0-10.0 mL/min (21.2 mm id) 0.2-1.2 mL/min (7.8 mm id) 0.1-0.4 mL/min (4.6 mm id)
150Å	5 µm	500-150,000	2-8.5	137 bar, 2000 psi	1.0-10.0 mL/min (21.2 mm id) 0.2-1.2 mL/min (7.8 mm id) 0.1-0.4 mL/min (4.6 mm id)
300Å	5 µm	5,000-1,250,000	2-8.5	137 bar, 2000 psi	1.0-10.0 mL/min (21.2 mm id) 0.2-1.2 mL/min (7.8 mm id) 0.1-0.4 mL/min (4.6 mm id)
500Å	5 µm	15,000-5,000,000	2-8.5	137 bar, 2000 psi	1.0-10.0 mL/min (21.2 mm id) 0.2-1.2 mL/min (7.8 mm id) 0.1-0.4 mL/min (4.6 mm id)
1000Å	5 µm	50,000-7,500,000	2-8.5	137 bar, 2000 psi	1.0-10.0 mL/min (21.2 mm id) 0.2-1.2 mL/min (7.8 mm id) 0.1-0.4 mL/min (4.6 mm id)
2000Å	5 µm	>10,000,000	2-8.5	137 bar, 2000 psi	1.0-10.0 mL/min (21.2 mm id) 0.2-1.2 mL/min (7.8 mm id) 0.1-0.4 mL/min (4.6 mm id)

Comparing Agilent Bio SEC-3 and Agilent Bio SEC-5

Analysis of monoclonal antibody

Column: Bio SEC-3, 300Å
5190-2511
7.8 x 300 mm, 3 μm

Column: Bio SEC-5, 300Å
5190-2526
7.8 x 300 mm, 5 μm

Mobile Phase: Sodium phosphate 150 mM, pH 7.0

Flow Rate: 1 mL/min

Detector: UV, 220 nm

Sample: Humanized monoclonal antibody

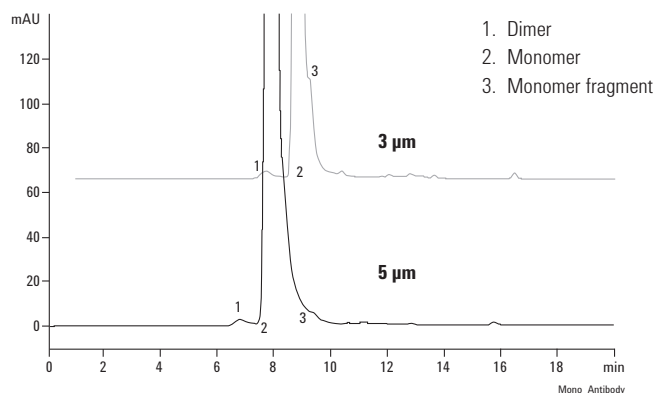

The 3 μm column gives higher definition of the fragmentation plan.

TIPS & TOOLS

There are many things to consider when developing aggregation analysis for your proteins; the effect of solute size and molecular weight, column selection choices, important mobile phase considerations, and more. For a guide on all of the above refer to:

Size exclusion chromatography for biomolecule analysis: A "How to" guide
(publication 5991-3651EN)

www.agilent.com/chem/library

Calibration curves – Bio SEC-5

Column: Bio SEC-5
7.8 x 300 mm, 5 µm

Mobile Phase: Sodium phosphate 150 mM, pH 7.0

Flow Rate: 1.0 mL/min

Detector: UV, 214 nm

Proteins	MW	Retention Volume				
		1000Å	500Å	300Å	150Å	100Å
Thyroglobulin	670,000	10.07	8.23	7.03	5.82	5.77
γ-Globulin	150,000	10.88	9.80	8.57	6.55	5.79
BSA	67,000	11.13	10.44	9.44	7.29	6.00
Ovalbumin	45,000	11.28	10.83	9.89	7.90	6.40
Myoglobin	17,000	11.44	11.28	10.42	8.66	7.05
Ribonuclease A	12,700	11.52	11.41	10.58	8.93	7.32
Vitamin B12	1,350	12.00	12.59	11.78	11.49	10.30
Uracil (total permeation marker)	112	12.08	12.68	12.21	12.13	11.41

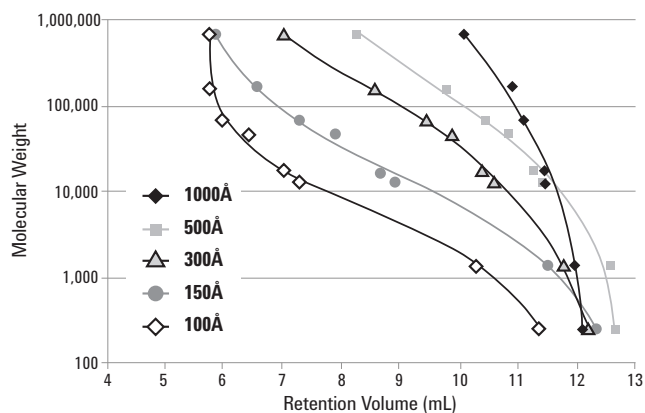

Side-by-side comparison

Column: Bio SEC-5
5190-2521
7.8 x 300 mm, 5 µm

Mobile Phase: Sodium phosphate 150 mM, pH 7.0

Flow Rate: 1.0 mL/min

Detector: UV, 214 nm

Separation of a protein mixture on an Agilent Bio SEC-5 HPLC column and a Tosoh TSK-Gel column. Notice the sharper peaks and better resolution on the Agilent Bio SEC-5 HPLC column.

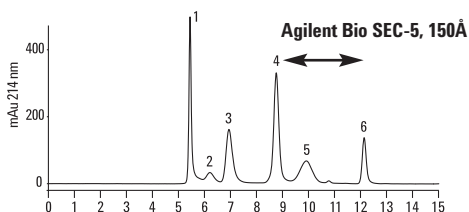

1. Thyroglobulin, 5.43 min
2. BSA dimer, 6.19 min
3. BSA monomer, 6.93 min
4. Ribonuclease A, 8.74 min
5. Poly-DL-alanine (1-5 kDa), 9.90 min
6. Uracil, 12.13 min

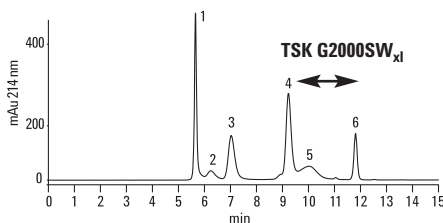

1. Thyroglobulin, 5.64 min
2. BSA dimer, 6.23 min
3. BSA monomer, 7.02 min
4. Ribonuclease A, 9.22 min
5. Poly-DL-alanine (1-5 kDa), 10.02 min
6. Uracil, 11.81 min

Exceptional lot-to-lot reproducibility

Column: Bio SEC-5, 150Å
5190-2521
7.8 x 300 mm, 5 µm

Mobile Phase: Sodium phosphate 150 mM, pH 7.0

The four protein mixture shows excellent retention time reproducibility over 300 injections and on three columns from different manufacturing lots.

1. Thyroglobulin
2. BSA
3. Ribonuclease A
4. Uracil

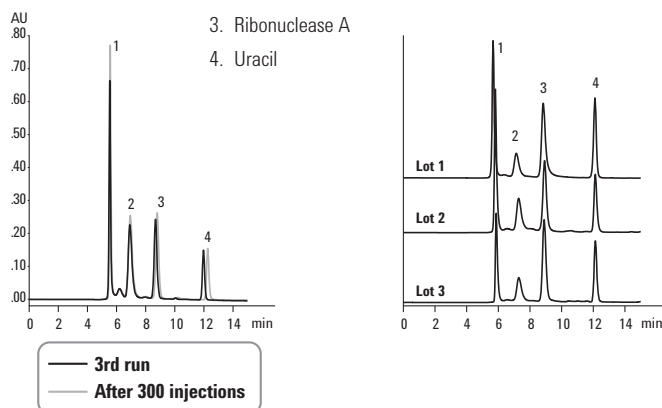

Agilent Bio SEC-5

Size (mm)	Particle Size (µm)	Bio SEC-5 100Å USP L33	Bio SEC-5 150Å USP L33	Bio SEC-5 300Å USP L33	Bio SEC-5 500Å USP L33	Bio SEC-5 1000Å USP L33	Bio SEC-5 2000Å USP L33
21.2 x 300	5	5190-6863	5190-6864	5190-6865	5190-6866	5190-6867	5190-6868
21.2 x 50, Guard	5	5190-6869	5190-6870	5190-6871	5190-6872	5190-6873	5190-6874
7.8 x 300	5	5190-2516	5190-2521	5190-2526	5190-2531	5190-2536	5190-2541
7.8 x 150	5	5190-2517	5190-2522	5190-2527	5190-2532	5190-2537	5190-2542
7.8 x 50, Guard	5	5190-2520	5190-2525	5190-2530	5190-2535	5190-2540	5190-2545
4.6 x 300	5	5190-2518	5190-2523	5190-2528	5190-2533	5190-2538	5190-2543
4.6 x 150	5	5190-2519	5190-2524	5190-2529	5190-2534	5190-2539	5190-2544
4.6 x 50, Guard	5	5190-6857	5190-6858	5190-6859	5190-6860	5190-6861	5190-6862



ProSEC 300S

- Stable performance: Mechanically robust silica particles that do not bleed during use
- Easy method development: Extended linear resolving range eliminates the need for pore size selection – a single column to analyze most globular proteins
- Choices to help you perfect your separation: Two column ids to suit multi-detector SEC
- Increased sensitivity when used with light-scattering detectors, to identify dimers, trimers, and aggregates

The Agilent ProSEC 300S column is specifically designed as a single column solution for globular protein analysis. The pore size selection and optimization provides an extended linear resolving range so that this single column can be used for analysis across the full range of globular proteins.

The particles are extremely robust and do not fragment during use to leach particulates. This gives exceptionally stable baselines making this column an ideal choice for use with light scattering detectors.

Two column dimensions, 7.5 mm id and 4.6 mm id, to suit multi-detector size exclusion chromatography provide an option for the analysis of small masses.

ProSEC 300S Column Specifications

Bonded Phase	Pore Size	Particle Size	Protein MW Range	pH Range	Flow Rate	Max Pressure
ProSEC 300S	300Å	5 µm	1,500-800,000	2-7.5	<1.5 mL/min (7.5 mm id) <0.5 mL/min (4.6 mm id)	250 bar, 3700 psi

ProSEC 300S

Dimensions	Particle Size (µm)	Part No.
7.5 x 600	5	PL1147-8501
7.5 x 300	5	PL1147-6501
4.6 x 250	5	PL1547-5501
Guard Columns		
7.5 x 50	5	PL1147-1501
4.6 x 50	5	PL1547-1501

Calibration of the ProSEC 300S column with globular proteins

Mobile Phase: Potassium phosphate 50 mM, sodium chloride 300 mM, pH 6.8

Flow Rate: 1.0 mL/min

Detector: UV, 280 nm

Sample: Protein samples

Mw/Daltons	Protein
670,000	Thyroglobulin
155,000	γ -Globulin
66,430	Bovine serum albumin
44,287	Ovalbumin
29,000	Carbonic anhydrase
16,700	Myoglobin
12,384	Cytochrome c
1,423	Bacitracin

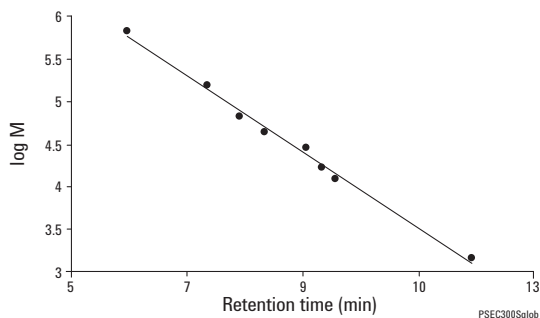

Analysis of bovine serum albumin by light scattering

Column: ProSEC 300S PL1147-6501 7.5 x 300 mm, 5 μ m

Mobile Phase: Phosphate buffered saline, pH 7.4

Flow Rate: 1.0 mL/min

Detector: Differential refractive index + 1260 Infinity Multi-Detector GPC/SEC System

Sample: Bovine serum albumin

Monomer 66,900 Daltons, 88.5%

Dimer 134,900 Da (2.02 x monomer molecular weight), 9.8%

Trimer 197,000 Da (2.94 x monomer molecular weight), 1.2%

Tetramer 279,300 Da (5.17 x monomer molecular weight), 0.5%

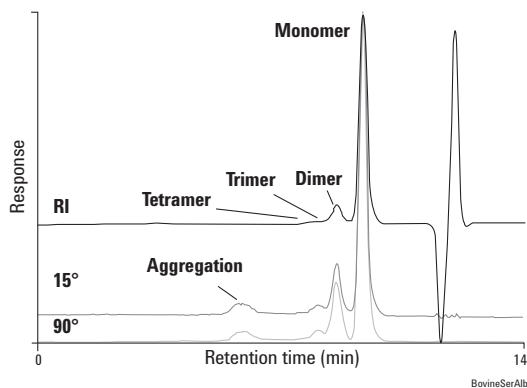

Overlay of differential refractive index and dual angle light scattering sample.

Overlay of UV and light scattering 90° for a sample of γ -globulins, illustrating monomer, dimer, and trimer peaks

Column: ProSEC 300S
PL1147-6501
7.5 x 300 mm, 5 μ m

Mobile Phase: Potassium phosphate 100 mM,
sodium chloride 300 mM, pH 8.0

Flow Rate: 1.0 mL/min

Temperature: 5 °C

Detector: UV, 310 nm + 1260 Infinity Multi-Detector
GPC/SEC System

Sample: Proteins

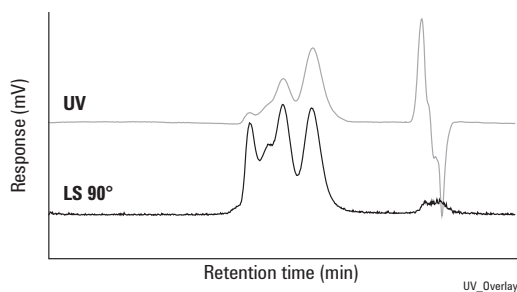

Overlay of UV and light scattering 90° for a sample of BSA, illustrating monomer, dimer, trimer, and aggregate peaks

Column: ProSEC 300S
PL1147-6501
7.5 x 300 mm, 5 μ m

Mobile Phase: Potassium phosphate 100 mM,
sodium chloride 300 mM, pH 8.0

Flow Rate: 1.0 mL/min

Temperature: 5 °C

Detector: UV, 310 nm + 1260 Infinity
Multi-Detector GPC/SEC System

Sample: Proteins

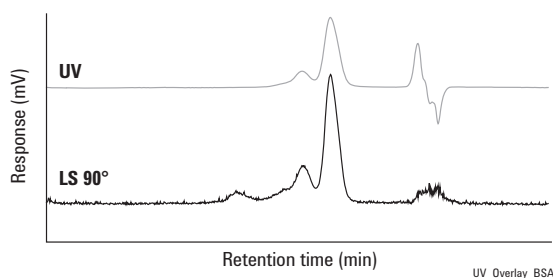

TIPS & TOOLS

Further information can be found in:

ProSEC 300S Protein Characterization Columns (publication 5990-7468EN)

Analysis of Globulins using Agilent ProSEC 300S Columns (publication 5990-7851EN)

Static Light Scattering Analysis of Globular Proteins with Agilent ProSEC 300S Columns
(publication 5990-7939EN)

www.agilent.com/chem/library



GF-250 Gel Filtration Columns

ZORBAX GF-250 and GF-450 Gel Filtration Columns

- Legacy products to be used where protocols state USP designation L35
- Semi-prep and prep column dimensions
- Compatible with organic modifiers and denaturants
- Wide usable pH range (3-8)

Agilent ZORBAX GF-250 and GF-450 size exclusion (gel filtration) columns are ideal for size separations of proteins and other biomolecules. The separation range is 4,000-900,000 for globular proteins when using GF-250 and GF-450 columns in series. The GF-250/GF-450 size exclusion columns have a hydrophilic diol bonded phase for high recovery of proteins (typically >90%) and a unique zirconia modification of the silica for a pH operating range from 3-8. The GF-250 and GF-450 columns are packed with precisely sized porous silica microspheres with narrow pore size and particle size distributions. The result is an efficient, rugged, and reproducible size exclusion column that can be used for both analytical and preparative separations of proteins with flow rates of up to 3 mL/min. These columns are compatible with organic modifiers (<25%) and denaturants in the mobile phase to reduce protein aggregation. Some common applications include separations of protein monomers, dimers and aggregates, desalting, protein molecular weight estimation, and separations of modified proteins.

UHPLC Column Specifications

Bonded Phase	Pore Size	Particle Size	MW Range	Surface Area	pH Range	Flow Rate	Max Pressure
ZORBAX GF-250	150Å	4 µm	4,000-400,000	140 m ² /g	3.0-8.0	<3.0 mL/min	350 bar
ZORBAX GF-450	300Å	6 µm	10,000-900,000	50 m ² /g	3.0-8.0	<3.0 mL/min	350 bar

Specifications represent typical values only

Retention volume versus log (MW) for Bio-Rad standards separated on an Agilent ZORBAX GF-250 column

Column: ZORBAX GF-250
884973-901
9.4 x 250 mm, 4 µm

Mobile Phase: Sodium phosphate 200 mM, pH 7.0

Temperature: Ambient

Detector: UV, 254 nm

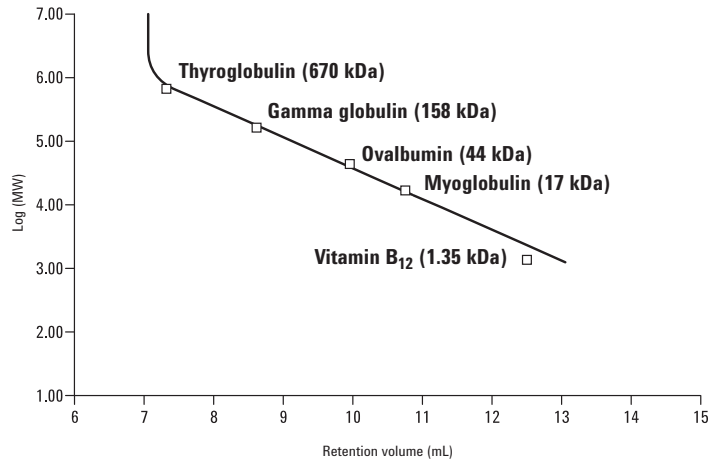

Separations of proteins on preparative columns

Column: ZORBAX GF-250
884973-901
9.4 x 250 mm, 4 µm

Column: ZORBAX GF-450
884973-902
9.4 x 250 mm, 6 µm

Mobile Phase: Sodium phosphate 200 mM, pH 7.0

Flow Rate: 5.0 mL/min

Detector: UV, 280 nm

Sample: 200 µL

ZORBAX GF-250

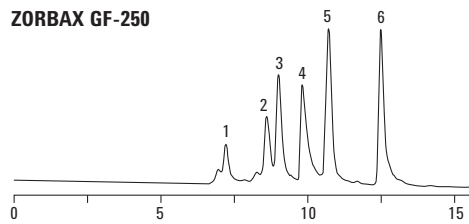





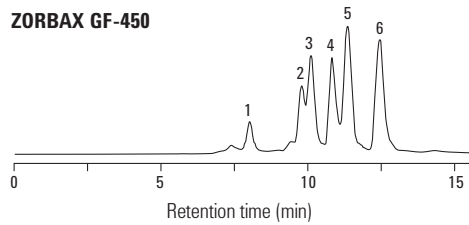





1. Thyroglobulin
2. Catalase
3. Bovine serum albumin
4. β-Lactoglobulin B
5. Myoglobin
6. Tyr-Gly-Gly

ZORBAX GF-450



ZORBAX GF-250 (USP L35) and GF-450 (USP L35) Gel Filtration Columns

Hardware Description	Size (mm)	Particle Size		Part No.
			(μm)	
GF-250, 150Å	9.4 x 250		4	884973-901
GF-250, 150Å	4.6 x 250		4	884973-701
GF-450, 300Å	9.4 x 250		6	884973-902
Guard Columns (hardware required)				
 GF-450 Diol, Guard Cartridge, 2/pk	9.4 x 15		6	820675-111
 GF-250 Diol, Guard Cartridge, 4/pk	4.6 x 12.5		6	820950-911
 GF-450 Diol, Guard Cartridge, 2/pk	9.4 x 15		6	820675-111
 Prep Guard Hardware Kit				840140-901
 Guard Hardware Kit				820999-901
PrepHT Columns				
 PrepHT GF-250, 150Å	21.2 x 250		6	877974-901
 PrepHT GF-450, 300Å	21.2 x 250		6	877974-910
 PrepHT Endfittings, 2/pk				820400-901
 PrepHT Guard Cartridge, 2/pk	17.0 x 7.5		5	820212-911
 Guard Cartridge Hardware				820444-901



GLYCOSYLATION CHARACTERIZATION

Post-translational modifications to the primary amino acid sequence, including glycosylation, have functional consequences and can impact efficacy and immunogenicity of a biopharmaceutical. The structure of the glycan also contributes to the half-life of the protein in plasma and the ability of the monoclonal antibody to trigger the immune response required for efficacy. Regulatory authorities consider glycosylation to be one of the critical quality attributes and, therefore, it must be characterized and quantified, with acceptable ranges determined, as part of the development process for a glycoprotein innovator, biosimilar or biobetter pharmaceutical.

There are a number of analytical methods that are used to obtain information about the structure and form of protein glycosylation.

- For structural identification, including identification of glycosylation sites, mass spec detection is used with reversed-phase and hydrophilic interaction chromatography (HILIC).
- The sialic acid containing glycans will also impart additional charge to the protein and can be characterized by ion-exchange chromatography.

Having characterized the glycoprotein and glycopeptide fragments to obtain information about the number and position of the glycosylation sites, it is then necessary to identify and quantify the individual glycans. To do this the glycans must be cleaved from the protein and analyzed using HILIC columns. As glycans have no chromophore, derivatization with a fluorophore is carried out to enable FLD detection to map and quantify the glycans.

Hydrophilic Interaction Column Selection

Application	Agilent Columns	Notes
Glycans cleaved from a glycoprotein including monoclonal antibodies	AdvanceBio Glycan Mapping	Amide bonded phase for rapid equilibration and enhanced selectivity for glycans
	1.8 μm	Based on a fully porous particle for high speed separations and high throughput applications. Stability to 1200 bar for use with the Agilent 1290 Infinity LC.
	2.7 μm	Based on Poroshell technology to give a superficially porous particle with reduced diffusion distances to give high resolution separations at lower pressures and enable the use of longer column lengths for increased separation efficiency.
Hydrophilic peptides and glycopeptides	ZORBAX RRHD 300Å, 1.8 μm	A 300Å silica particle to provide an orthogonal separation to the ZORBAX RRHD 300Å, 1.8 μm reversed-phase columns
	AdvanceBio Glycan Mapping	The amide bonded phase provides an alternative HILIC functionality for small hydrophilic and glycopeptides



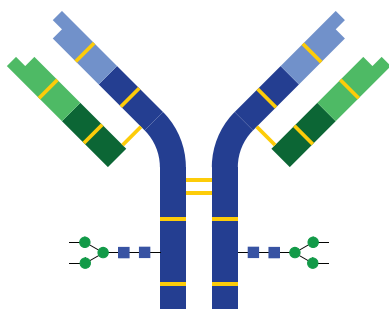

N-Glycan Analysis

AdvanceBio Glycan Mapping columns, standards, and sample preparation products for the selective removal of the N-glycans from a glycoprotein, including monoclonal antibodies.

- **Speed of analysis** – 1.8 μm columns provide high throughput N-glycan analysis where speed is the primary concern either due to the number of samples or to the immediate requirement for data.
- **Resolution** – high resolution separations are achieved using the 2.7 μm particles packed in the 250 mm column. This increased resolution enables accurate quantitation of target glycans and changes to the protein glycosylation profile which may have occurred during expression.
- **Comprehensive methods** – for sample preparation, chromatographic analysis, and data interpretations to ensure reproducibility, and accuracy of identification and quantitation
- **Simplicity of ordering** – a single part number to order the full sample preparation workflow, for protein solubilization to purification, of the 2-AB labeled glycans plus kits for each part of the sample preparation workflow for versatility.

Column Specifications

Bonded Phase	ID (mm)	Particle Size (μm)	Endcapped	pH Stability	Operating Temperature	Pressure Limit
Amide HILIC	2.1 and 4.6	1.8, fully porous	No	2-7	60 °C	1200 bar
Amide HILIC	2.1 and 4.6	2.7, superficially porous	No	2-7	60 °C	600 bar

The mapping of the N-linked glycan component of a glycoprotein, including monoclonal antibodies, requires the N-glycans to be enzymatically cleaved, using PNGase F, from the protein amino acid backbone. The cleaved N-glycans can be analyzed by hydrophilic interaction chromatography with MS detection, or after derivatization with a fluorophore, 2-aminobenzamide (2-AB) analyzed using HPLC/UHPLC using either FLD or MS. The AdvanceBio Glycan columns provide both speed of analysis, 1.8 μm , and resolution, 2.7 μm , for the identification and quantitation of the cleaved glycans.

Speed of Analysis

The AdvanceBio Glycan Mapping 1.8 μm columns are recommended for high throughput analysis where short run times are required.

Superior results – in 40% less time than the competition

Column A: AdvanceBio Glycan Mapping 859700-913 2.1 x 150 mm, 1.8 μm

Column B: Competitor sub-2 μm glycan column

Instrument: Agilent 1290 Infinity LC with 1260 Infinity Fluorescence Detector (FLD)

Column Temperature: 55 °C

Sample Thermostat: 10 °C

Mobile Phase: A: 100 mM NH₄Formate, pH 4.5
B: ACN

FLD: Excitation = 260
Emission = 430

Injection Volume: 2 μL in 70:30 ACN: 100 mM NH₄Formate

Sample: Agilent 2-AB labeled N-linked Human IgG glycan library (p/n 5190-6996)

Time	%A	%B	Flow Rate mL/min
0	20	80	0.5
25	40	60	0.5
26	100	0	0.5
27	40	80	0.5

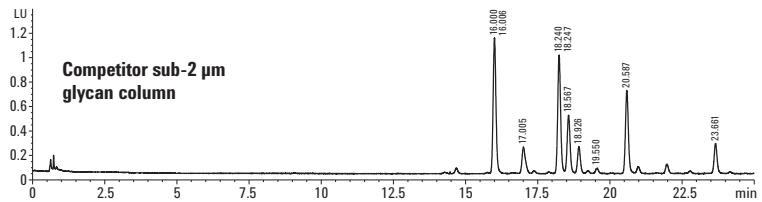
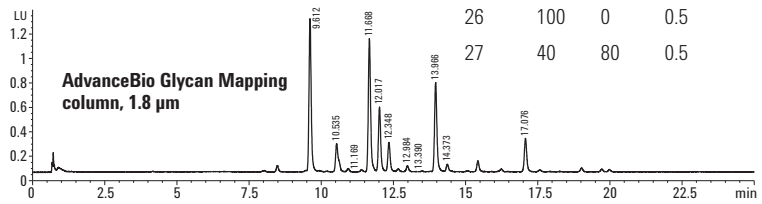

The Agilent AdvanceBio Glycan Mapping column delivers better resolution, narrower bands, and higher peak capacity than the non-Agilent sub-2 μm column in a 2.1 x 150 mm configuration.

Resolution

The AdvanceBio Glycan Mapping 2.7 μm media, in longer column lengths, are recommended for high resolution separations.

Analysis of complex non fucosylated biantennary and triantennary glycans containing NeuAc

Column: AdvanceBio Glycan Mapping
859700-913
2.1 x 150 mm, 1.8 μm

Instrument: Agilent 1290 Infinity Binary LC

Buffer: A: 100 mM ammonium formate in water, pH 4.5
B: Acetonitrile

MS Conditions: Gas Temperature: 250 °C
Sheath Gas Temperature: 250 °C
Gas Flow: 8 L/min
Sheath Gas Flow: 8 L/min
Nebulizer: 25 psi
Vcap: 3,500 V
Nozzle: 1,000 V
Fragmentor: 200 V
Skimmer: 45 V
Oct 1 RF Vpp: 550
Collision Energies: 15 and 30 V
Mode: MS and targeted MS/MS

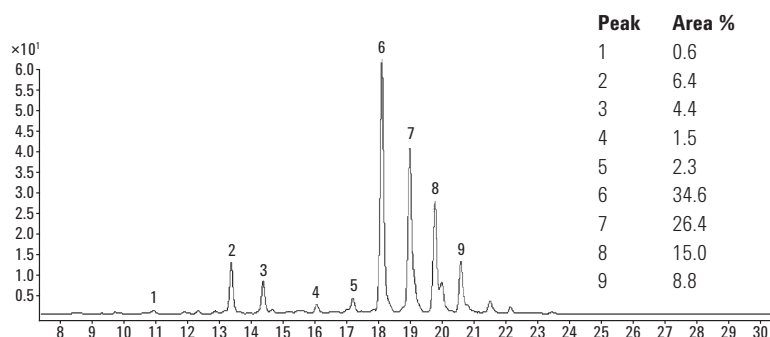

The N-glycans cleaved from fetuin using PNGase F were analyzed after 2-AB derivatization using UHPLC-FLD. The peak assignment by MS shows that the N-glycans cleaved from fetuin are complex biantennary and triantennary glycans containing N-acetylneuramic acid (NeuAc) but no fucose.

Fetuin 2-AB N-glycans analyzed using HILIC-UHPLC with peak assignments determined by MS.

Instrument Conditions

	Antibody Standard Gradient	Fetuin Gradient	Ovalbumin Gradient
Starting Flow Rate:	0.5 mL/min	0.5 mL/min	0.5 mL/min
Gradient:	0 min 85% B 5 min 75% B 35 min 64% B 40 min 50% B 42 min, flow 0.5 mL/min 42.01 min, flow 0.25 mL/min 43 min, 0% B 48 min 0% B 50 min 85% B 50.01 min, flow 0.25 mL/min 51 min, flow 0.5 mL/min	0 min 75% B 45 min 50% B 47 min 40% B, flow 0.5 mL/min 47.01 min, flow 0.25 mL/min 49 min 0% B 51 min 0% B 51.01 min 75% B, flow 0.25 mL/min 52.00 min, flow 0.5 mL/min	0-6 min 85% B 10 min 80% B 60 min 70% B 65 min 50% B, flow 0.5 mL/min 65.01 min, flow 0.25 mL/min 68 min 0% B 73 min 0% B 74 min 85% B, flow 0.25 mL/min 75.00 min, flow 0.5 mL/min
Stop Time:	51 min	52 min	75 min
Posttime:	20 min	20 min	20 min
Injection Volume:	5 μL	1 μL	1 μL
Thermostat Autosampler:	5 °C		
Column Temperature:	60 °C		
FLD:	Excitation = 260 nm Emission = 430 nm		
Peak Width:	>0.013 min (0.25 s resp. time) (37.04 Hz)		

Detailed information of N-glycan ovalbumins

Peak	Oxford	Structure
1	A2G2S1	
2,3	A2G2S2	
4	A3GGS2	
5	A3G3S3, A3G3S2 (trace)	
6	A3G3S3, A3G3S2 (trace)	
7	A3G3S3, A3G3S4 (trace)	
8	A3G3S4, A3G3S3	
9	A3G3S4	

- ▲ Fucose
- Galactose
- Mannose
- N-acetylglucosamine
- ◆ N-acetylneuramic acid

N-Glycan Standards

Agilent provides the reference materials, IgG N-linked glycan standard, and dextran ladder standard, needed as part of the workflow to ensure optimum performance of both sample preparation and the LC system. The two standards are available with the 2-AB label attached and also without the 2-AB label for use as sample preparation reference materials.

The IgG N-linked glycan standard is used as a QA test for every batch of the AdvanceBio Glycan mapping media to ensure each column meets the stringent reproducibility requirements for this demanding analysis.

The dextran ladder standard is used for calibrating the system based on elution times of the glucose units (GU) in the dextran homologous series and for reporting out GU relative retention data.

Separation of a 2-AB labeled dextran ladder

Column: AdvanceBio Glycan Mapping
859700-913
2.1 x 150 mm, 1.8 µm

Mobile Phase: A: 100 mM NH₄Fc, pH 4.5
B: ACN

FLD: Excitation = 260 nm
Emission = 430 nm

Injection Volume: 2 µL (10 pmol total glycan/1 µL 75:25 ACN:water)

Sample: Agilent 2-AB (p/n 5190-6998) labeled dextran ladder

This analysis uses the Agilent dextran ladder standard, together with an AdvanceBio Glycan Mapping column to correlate retention times of unknown glycans.

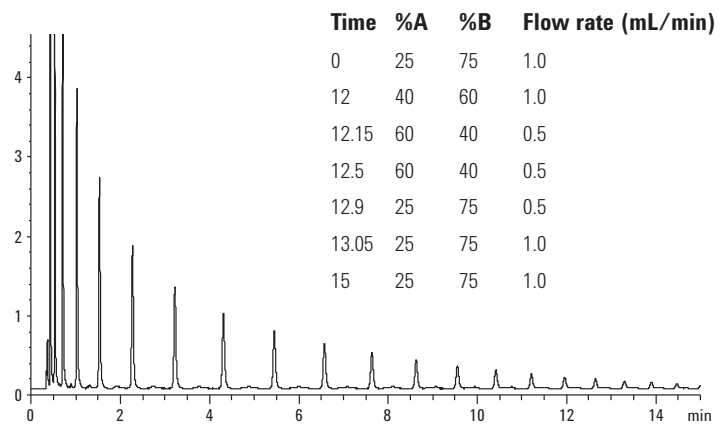

N-Glycan Sample Preparation

The preparation of the N-Linked glycans for analysis is a multiple step process requiring carefully controlled methodologies to achieve accurate and precise LC identification and quantitation of the glycans. Agilent provides all the components needed for the sample prep workflow with a comprehensive procedure to simplify the process.

Denature and deglycosylation	24 samples: 5190-8001 96 samples: 5190-8006
Cleanup cartridges to remove protein	24 samples: 5190-8002 96 samples: 5190-8007
2-AB labeling of cleaved glycans	24 samples: 5190-8003 96 samples: 5190-8008
Cleanup cartridges to remove excess reagents	24 samples: 5190-8004 96 samples: 5190-8009
Complete sample prep workflow	24 samples: 5190-8000 96 samples: 5190-8005

The sample prep products for the preparation of 24 or 96 samples.

AdvanceBio Glycan Mapping, 1.8 μm , stable to 1200 bar

Size (mm)	Part No.
2.1 x 150	859700-913
2.1 x 100	858700-913
2.1, 1.8 μm , Fast Guard	821725-905

AdvanceBio Glycan Mapping, 2.7 μm , superficially porous, stable to 1200 bar

Size (mm)	Part No.
4.6 x 250	680975-913
4.6 x 150	683975-913
4.6 x 100	685975-913
2.1 x 250	651750-913
2.1 x 150	683775-913
2.1 x 100	685775-913
2.1, 2.7 μm , Fast Guard	821725-906

N-Glycan Standards

Description	Part No.
Dextran ladder standard, 10 μg , 0.5 mL vial	5190-6997
2-AB labeled dextran ladder standard, 200 pmol	5190-6998
IgG N-linked glycan library, 20 μg , 0.5 mL	5190-6995
2-AB labeled IgG N-linked glycan library, 200 pmol	5190-6996

N-Glycan Sample Preparation

Description	Part No.
AdvanceBio N-glycan sample preparation kit, 24 samples Comprises part numbers: 5190-8001, 5190-8002, 5190-8003, and 5190-8004 to give the complete deglycosylation and 2-AB labeling of the cleaved N-glycans sample prep workflow for 24 samples of glycoproteins.	5190-8000
AdvanceBio N-glycan deglycosylation kit, 24 samples	5190-8001
AdvanceBio N-glycan deglycosylation cleanup cartridge, 24 samples	5190-8002
AdvanceBio 2-AB glycan labeling kit, 24 samples	5190-8003
AdvanceBio 2-AB glycan labeling cleanup cartridge, 24 samples	5190-8004
AdvanceBio N-glycan sample preparation kit, 96 samples Comprises part numbers: 5190-8006, 5190-8007, 5190-8008, and 5190-8009 to give the complete deglycosylation and 2-AB labeling of the cleaved N-glycans sample prep workflow for 96 samples of glycoproteins.	5190-8005
AdvanceBio N-glycan deglycosylation kit, 96 samples	5190-8006
AdvanceBio N-glycan deglycosylation cleanup cartridge, 96 samples	5190-8007
AdvanceBio 2-AB glycan labeling kit, 96 samples	5190-8008
AdvanceBio 2-AB glycan labeling cleanup cartridge, 96 samples	5190-8009
96-well plate for deglycosylation and labeling	5190-8010

Hydrophilic and Glycopeptide Analysis

Peptide analysis demands high selectivity and run-to-run reproducibility as provided by reversed-phase chromatography. However, reversed-phase columns have limited retention and selectivity for hydrophilic peptides, including glycopeptides. The ZORBAX RRHD 300-HILIC, 1.8 μm columns provide increased retention of hydrophilic and glycopeptides compared to reversed-phase columns so that valuable information is not lost when doing peptide mapping experiments. The two techniques are orthogonal and provide complementary information for protein primary structure analysis.

- A ZORBAX 300Å particle for analysis across the range of peptide sizes
- The 1.8 μm particle delivers UHPLC performance with 1200 bar stability
- Provides UHPLC orthogonality when used with the ZORBAX RRHD 300Å reversed-phase columns

Column Specifications

Bonded Phase	ID (mm)	Particle Size (μm)	Endcapped	pH Stability	Operating Temperature	Pressure Limit
Silica	2.1	1.8, fully porous	No	1-8	40 °C	1200 bar

Peptide mapping is used for characterization and impurity profiling of protein biotherapeutics. Reversed-phase UHPLC/HPLC is routinely used but when the digest contains hydrophilic peptides, such as glycopeptides, valuable information may be missed. The ZORBAX RRHD 300-HILIC column retains the hydrophilic glycopeptides, and when coupled with mass spectrometry provides identification of this important group of protein fragments.

Glycopeptide identification in a protein tryptic digest

Column: ZORBAX RRHD 300-HILIC
858750-901
2.1 x 100 mm, 1.8 µm

Mobile Phase: A: 100% ACN
B: 50 mM ammonium formate, pH 4.5

Flow Rate: 0.4 mL/min

Injection: 5 µg

Detector: UV, 280 nm

Instrument: Agilent 1290 Infinity LC, Agilent 6224 Accurate Mass TOF-MS,
Agilent Dual ESI Source in Positive Ion Mode

Sample: Glycopeptide from digested EPO protein (1 mg/mL)

Figure UV shows the separation of an erythropoietin (EPO) peptide map using the ZORBAX RRHD 300-HILIC 2.1 x 100 mm column and Figure Mass Spec shows the extracted compound chromatograms of matched EPO.

Seven peptides were identified from the HILIC-MS data that were not identified by RP-MS.

HILIC is orthogonal to RP and provides additional resolution of the hydrophilic glycopeptides, in a protein enzyme digest.

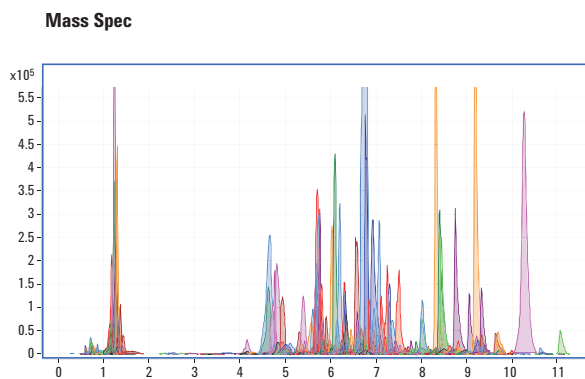
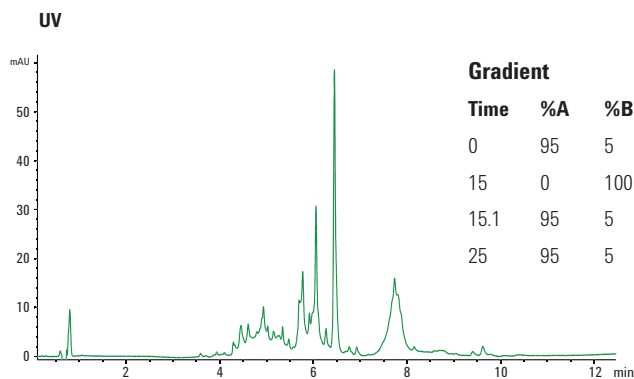

Agilent ZORBAX RRHD 300-HILIC 1.8 µm columns

Description	ID (mm)	Particle Size (µm)	Part No.
ZORBAX RRHD 300-HILIC	2.1 x 100	1.8	858750-901
ZORBAX RRHD 300-HILIC	2.1 x 50	1.8	857750-901



Bio-Monolith Protein A Column, 5069-3639

TITER DETERMINATION

Affinity chromatography is a powerful technique which takes advantage of highly specific molecular interactions, frequently between specific proteins (e.g. antigen/antibody). Agilent offers several specialty affinity products, a monolithic Protein A column for the isolation and quantitation of IgG and a series of Multiple Affinity Removal Systems for the elimination of high abundance proteins in biological samples.

Agilent Bio-Monolith Protein A HPLC Columns

- Designed for the analytical separation of all IgG (human and mouse), except for IgG class 3
- Flow rate independent separations; no diffusion, no pores, and no void volume make transport between mobile and stationary phase very rapid
- Extremely fast separations speed up method development time and decrease costs
- Locking in method parameters takes significantly less time and buffer

Agilent Bio-Monolith Protein A HPLC columns are part of the Agilent Bio-Monolith column family. Protein A Bio-Monolith columns are compatible with HPLC and preparative LC systems, including Agilent 1100, 1200, and 1260 Bio-inert Quaternary LC.

TIPS & TOOLS

For more information on salt tolerance for mAb binding and acidic buffers compatibility for mAb elution on Agilent Bio-Monolith Protein A columns, see publication 5991-2990EN

www.agilent.com/chem/library

Column Specifications

Dimensions	5.2 mm x 4.95 mm
Column volume	100 μ L
Maximum pressure	150 bar (15 MPa, 2,200 psi)
Temperature min/max	Operating: 2-40 °C Storage: 2-8 °C
Recommended pH	Operating range: 2-13 Cleaning-in-place: 1-14
Materials of construction	Hardware: stainless steel Packing: poly(glycidyl methacrylate-co-ethylene dimethacrylate) highly porous monolith
Color ring identifier	Bio-Monolith Protein A: white
Shelf life/expiration date	Protein A: 12 months

Bio-Monolith Protein A

Column	Description	Key Applications	Part No.
Bio-Monolith Protein A	The Protein A affinity column is designed for the analytical separation of IgG1 and IgG2 (human and mouse).	Quantitative determination of IgG (fermentation titer calculation)	5069-3639

TIPS & TOOLS

Further information can be found in:

mAb Titer Analysis with the Agilent Bio-Monolith Protein A Column
(publication 5991-5135EN)

Agilent Bio-Monolith Protein A Monitors Monoclonal Antibody Titer from Cell Cultures
(publication 5991-2990EN)

Cell Clone Selection Using the Agilent Bio-Monolith Protein A Column and LC/MS
(publication 5991-5124EN)

Cell Culture Optimization Using an Agilent Bio-Monolith Protein A Column and LC/MS
(publication 5991-5125EN)

www.agilent.com/chem/library

Rapid humanized monoclonal antibody quantitation

Column: Bio-Monolith Protein A
5069-3639
5.2 x 4.95 mm

Mobile Phase: A: 50 mM phosphate, pH 7.4
B: 100 mM citric acid, pH 2.8

Flow Rate: 1 mL/min

Injection Volume: Variable (50 μ L, optimized for CHO cell culture supernatant contains IgG1)

Gradient:

Time (min)	%A	%B	
0 to 0.5	100	0	Binding
0.6 to 1.7	0	100	Eluting
1.8 to 3.5	100	0	Re-equilibrating

Temperature: Ambient

Detector: UV, 280 nm

Fraction Collection: Time-based

Sample: IgG1 (1-20 mg/mL) and CHO cell supernatant contains IgG1 (up to 20 mg/mL total protein)

	RT (min)	Peak area
1	383	1.666
2	372	1.666
3	365	1.665
4	389	1.667
5	383	1.666
6	378	1.666
7	379	1.668
8	377	1.666
9	376	1.667
10	377	1.667
Mean	378	1.667
S	6.52	0.001
%RSD	1.73	0.060

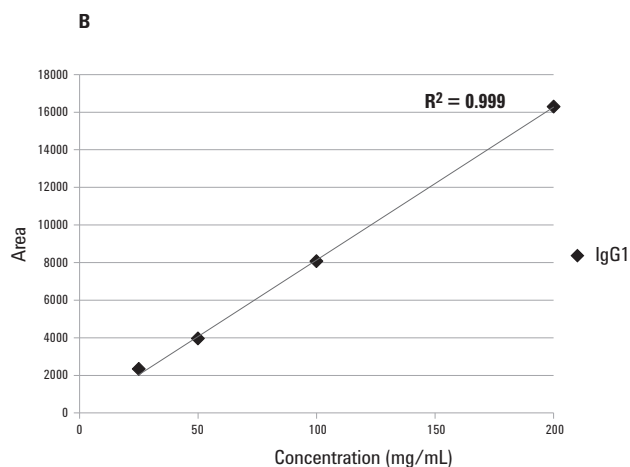
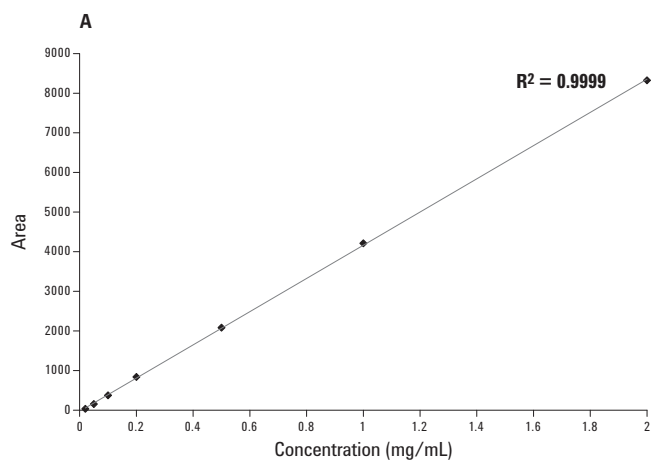

Calibration curves of modified humanized Herceptin (panel A: 0-2 mg/mL, and B: 25-200 mg/mL)

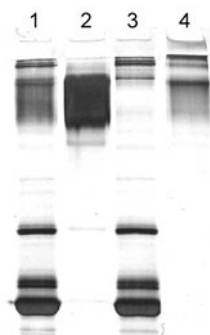

Key:

Lane 1: Whole serum prior to separation
Lane 2: IgG standard
Lane 3: Peak 1 (flow-through fraction)
Lane 4: Peak 2 (Protein A-bound fraction; i.e. IgG1)

SDS PAGE analysis of fractions from the separation

No impact on binding efficiency with high flow rate

Column: Bio-Monolith Protein A
5069-3639
5.2 x 4.95 mm

Mobile Phase: A: Sodium phosphate buffer, 20 mM, pH 7.4
B: Citric acid, 0.1 M, pH 2.8

Flow Rate: 1.0, 1.5, and 2.0 mL/min

Gradient: 0% B for 0.5 min, 100% B from 0.6-1.7 min, 0% B from 1.8-3 min

Temperature: 25 °C

Injection: 4 µL (from 2.5 mg/mL IgG1 spiked with 20 mg/mL of *E.coli* supernatant)

Detector: UV, 280 nm

Sample: Humanized IgG1 and *E.coli* lysate

Instrument: Agilent 1260 Infinity Bio-inert Quaternary LC

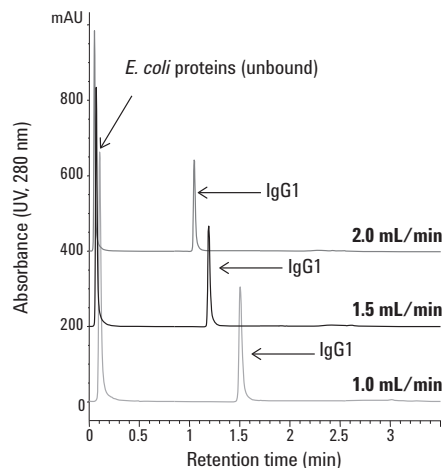

Binding of IgG1 with the Agilent Bio-Monolith Protein A column evaluated at several flow rates. More sample was loaded for this study to easily observe changes in chromatogram and signal integration.

Flow rate versus peak relative area on unbound proteins and IgG1

Flow rate (mL/min)	Unbound area (mAu/S)	IgG1 area (mAu/S)	Unbound relative area (%)	IgG1 relative area (%)	Pressure (bar)
1.0	1230	738	63	37	32
1.5	840	492	63	37	47
2.0	636	363	64	36	68



PROTEIN DEPLETION

To more easily isolate and identify proteins in biological samples, such as serum, plasma, and cerebrospinal fluid (CSF), the Agilent Multiple Affinity Removal System is designed to chromatographically eliminate interfering high-abundance proteins from biological samples. Removal of these abundant proteins improves the subsequent LC/MS and electrophoretic analysis of the sample by effectively expanding the dynamic range.

Agilent Protein Fractionation System and Proteomics Reagents

- LC/MS analysis of biological samples
- Preparation for electrophoretic analysis
- Sample preparation for biomarker discovery
- Instrument and workflow validation
- Cost-effective immunodepletion
- Sample desalting, concentration, and fractionation

For sample fractionation and desalting, the Agilent mRP-C18 High-Recovery Protein column is designed to simultaneously desalt, concentrate, and fractionate in one easy step with extremely high recovery of samples as compared to conventional RP-HPLC columns that are fully compatible with LC/MS analysis.

In addition, validated reagents for sample preparation in biomarker discovery and other proteomics applications are also available, including a complex standard, and proteomics grade trypsin. For your convenience, these reagents are fully compatible with Agilent LC/MS methods and require no additional sample pretreatments.

Large volume requirements and custom column dimensions can also be addressed with our custom configurations.



Multiple Affinity Removal System

Multiple Affinity Removal System

The Multiple Affinity Removal System from Agilent enables the identification and characterization of high-value, low abundant proteins and biomarkers found in serum, plasma, and other biological fluids.

The Multiple Affinity Removal System reproducibly and specifically removes up to fourteen high-abundant proteins found in human biological fluids and three high-abundant proteins found in mouse biological fluids.

The Multiple Affinity Removal System is available in a variety of LC column dimensions and in spin cartridge format. When combined with Agilent optimized buffers, convenient spin filters, and concentrators, the Agilent Multiple Affinity Removal System creates an automated, integrated depletion solution compatible with most LC instruments (columns), and bench-top centrifuges (spin cartridges).

Samples depleted using the Multiple Affinity Removal System are ready for downstream analyses such as 2D gel electrophoresis, LC/MS, and other analytical techniques.

TIPS & TOOLS

For more information on how to reduce your cycle time for affinity chromatography refer to:
Reducing Cycle Time for Affinity Removal of High-Abundant Proteins in Human Plasma. Alternating Column Regeneration Using an Agilent 1200 Infinity Series Quick-Change Bio-inert 2-position/10-port Valve and an Agilent 1290 Infinity Flexible Cube
(publication 5991-4721EN)

www.agilent.com/chem/library

Multiple Affinity Removal System Selection Guide

Product	Proteins Removed	Total Protein Removed	Dimension	Load Capacity	Part No.
MARS Human-14	Albumin, IgG, antitrypsin, IgA, transferrin, haptoglobin, fibrinogen, alpha2-macroglobulin, alpha1-acid glycoprotein, IgM, apolipoprotein AI, apolipoprotein AII, complement C3, transthyretin	94%	Spin Cartridge	8-10 µL	5188-6560
			4.6 x 50 mm	20 µL	5188-6557
			4.6 x 100 mm	40 µL	5188-6558
			10.0 x 100 mm	250 µL	5188-6559
MARS Human-7	Albumin, IgG, IgA, transferrin, haptoglobin, antitrypsin, fibrinogen	88-92%	Spin Cartridge	12-14 µL	5188-6408
			4.6 x 50 mm	30-35 µL	5188-6409
			4.6 x 100 mm	60-70 µL	5188-6410
			10.0 x 100 mm	250-300 µL	5188-6411
MARS Human-6	Albumin, IgG, IgA, transferrin, haptoglobin, antitrypsin	85-90%	Spin Cartridge	7-10 µL	5188-5230
			4.6 x 50 mm	15-20 µL	5185-5984
			4.6 x 100 mm	30-40 µL	5185-5985
MARS Human-6 High Capacity	Albumin, IgG, IgA, transferrin, haptoglobin, antitrypsin	85-90%	Spin Cartridge	14-16 µL	5188-5341
			4.6 x 50 mm	30-40 µL	5188-5332
			4.6 x 100 mm	60-80 µL	5188-5333
			10.0 x 100 mm	up to 340 µL	5188-5336
MARS Human-2	Albumin, IgG	69%	Spin Cartridge	50 µL	5188-8825
			4.6 x 50 mm	100 µL	5188-8826
MARS Human-1	Albumin	50-55%	Spin Cartridge	65 µL	5188-5334
			4.6 x 50 mm	130 µL	5188-6562
MARS Mouse-3	Albumin, IgG, transferrin	80%	Spin Cartridge	25-30 µL	5188-5289
			4.6 x 50 mm	37-50 µL	5188-5217
			4.6 x 100 mm	75-100 µL	5188-5218

High abundance proteins removed by Agilent Multiple Affinity Removal Columns and Spin Cartridges

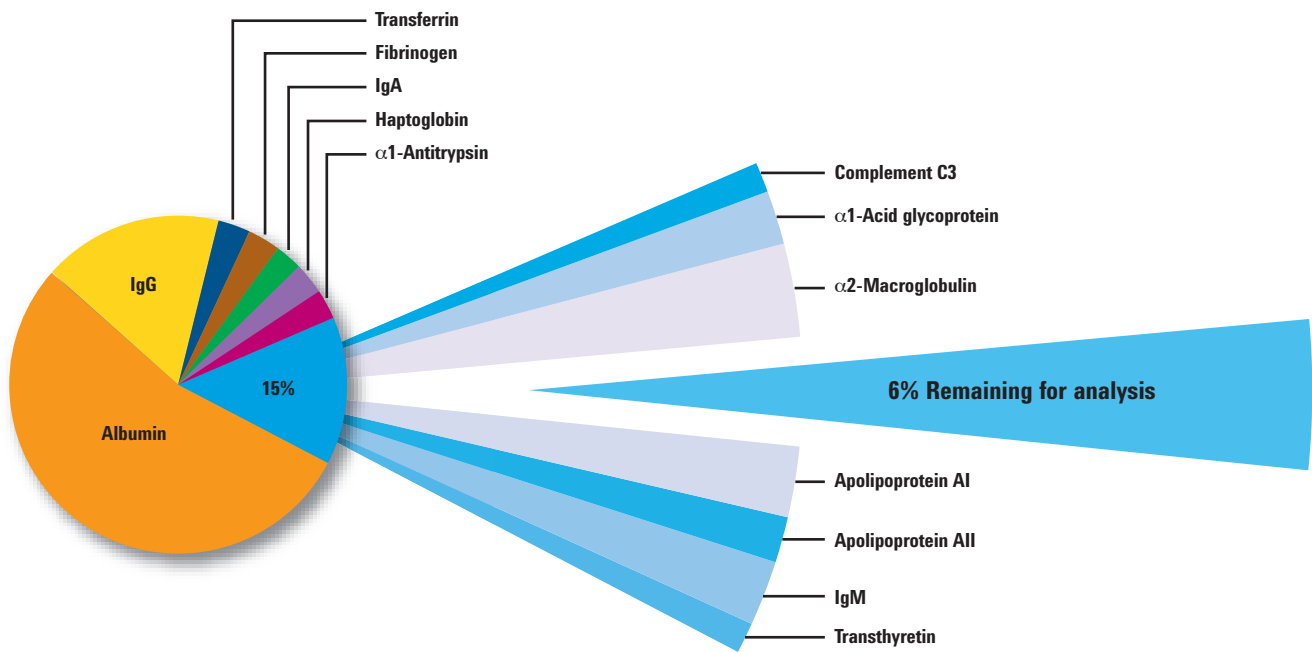

TIPS & TOOLS

Learn more about Agilent's complete services portfolio at www.agilent.com/chem/services



LC Column Reagent Starter Kit, 5185-5986



Luer-Lok syringe, 5188-5250



Luer-Lok adapters, 5188-5249



Luer-Lok needles, 5188-5253

Multiple Affinity Removal System Starter Kits

The LC Column and Spin Cartridge Reagent Starter Kits include all the required supplies to use with the Multiple Affinity Removal System. These buffers provide optimal conditions for column longevity and sample reproducibility.

- The kits provide enough Buffer A and Buffer B for approximately 200 sample depletions using the 4.6 x 50 mm LC columns, approximately 100 sample depletions using the 4.6 x 100 mm LC columns and 200 spin cartridge uses.
- Buffer A, the loading buffer, minimizes protein-protein interactions, allowing low-abundant proteins often bound to high-abundant proteins to pass through the column, while the targeted high-abundant proteins bind to their associated antibodies.
- Buffer B, the elution buffer, then disrupts the antibody-protein interaction eluting the high-abundant proteins off the column.

Multiple Affinity Removal System Starter Kits

Description	Part No.
LC Column Reagent Starter Kit	5185-5986
Includes:	
Buffer A, for loading, washing, and equilibrating, 1 L	5185-5987
Buffer B, for eluting, 1 L	5185-5988
0.22 μ m cellulose acetate, 25/pk, 1 L	5185-5990
Spin concentrators, 5K MWCO, 4 mL, 25/pk	5185-5991
Multiple Affinity Removal Spin Cartridge Reagent Kit	5188-5254
Includes:	
Buffer A, for loading, washing, and equilibrating, 1 L	5185-5987
Buffer B, for eluting, 1 L	5185-5988
Spin filters, 0.22 μ m cellulose acetate, 25/pk, qty 2	5185-5990
Spin concentrators, 5K MWCO, 4 mL, 25/pk	5185-5991
Luer-Lok adapters, 2/pk	5188-5249
Plastic syringe, 5 mL, Luer-Lok, 2/pk	5188-5250
Microtube, 1.5 mL, screw top, 100/pk, qty 6	5188-5251
Caps and plugs, 6/pk	5188-5252
PTFE needles, Luer-Lok, 10/pk	5188-5253
High concentration sample dilution buffer, 50 mL	5188-8283



Nano Columns

SPECIALTY DIMENSIONS

Capillary and Nano Columns

- Highest sensitivity for your smallest sample sizes
- Compatible with all LC/MS interfaces
- Internal diameters of 0.5, 0.3, 0.1, and 0.075 mm
- 300Å pore sizes for biomolecule analysis
- Ideal for 1D and 2D (proteomics) applications

Agilent ZORBAX capillary (0.5 and 0.3 mm id) and nano (0.1 and 0.075 mm id) columns are available in a wide variety of phases, and dimensions. These columns are ideal for very sample-limited applications because they provide enhanced sensitivity by reducing on-column sample dilution. This high sensitivity can be provided with exceptional reproducibility using Agilent columns and low dispersion UHPLC instruments such as the Agilent 1290 Infinity LC. The fastest growing application for capillary and nano columns is 2D LC/MS for complex proteomics samples. Agilent provides all the columns and instruments needed for the 2D separation – SCX columns for the first dimension, the reversed-phase trapping column, and the reversed-phase column for the second dimension.

TIPS & TOOLS

Agilent offers a variety of e-Seminars and on-site training to help you learn how to be a more effective chromatographer.

For more information, visit www.agilent.com/chem/education



High sensitivity protein digest analysis by LC/MS

Column: ZORBAX 300SB-C18
5065-9911
0.075 x 150 mm, 3.5 μ m

Mobile Phase: A: Water + 0.1% formic acid
B: ACN + 0.1% formic acid

Flow Rate: 600 nL/min

Gradient: 2% B to 52% B in 25 min

Detector: Positive ion nano Electrospray MS

Sample: Digest of eight proteins 100 fm (1 μ L)

A ZORBAX nano HPLC column, 0.075 mm id, is used for high sensitivity LC/MS analysis of a protein digest sample.

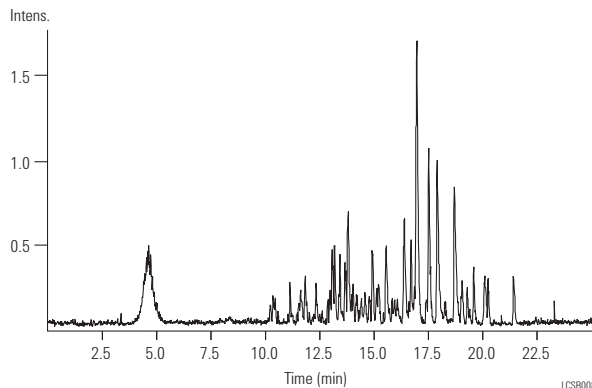

LCS8008

High sensitivity with capillary columns

Column: ZORBAX SB-C18
5064-8255
0.3 x 150 mm, 5 μ m

Column: ZORBAX SB-C18
5064-8256
0.5 x 150 mm, 5 μ m

Column: ZORBAX SB-C18
863600-902
1.0 x 150 mm, 3.5 μ m

Column: ZORBAX SB-C18
883975-902
4.6 x 150 mm, 5 μ m

Sample: Biphenyl 200 ng

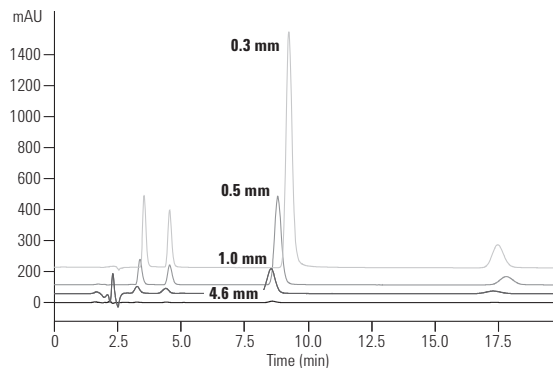

LCCN002

Sample-limited applications require capillary column dimensions to minimize on-column sample dilution and to enhance sensitivity. The 0.3 mm capillary in this example provides 100 times more sensitivity than the standard 4.6 mm column. Agilent nanobore (0.1 mm to 0.075 mm id) columns can provide up to 2,000 times more sensitivity for your most limited sample applications.

Human serum: low abundance protein isolation and identification from 1D gel band by LC/MS

Column: ZORBAX 300SB-C18
Trap: 0.3 x 5 mm, 5 μ m, 5065-9913
Analytical: 0.3 x 150 mm, 5 μ m, 5064-8263

Mobile Phase: A: Water + 0.1% formic acid
 B: Acetonitrile + 0.1% formic acid

Flow Rate: 6 μ L/min

Gradient: 0 min 3% B
 5 min 3% B (loading)
 50 min 45% B
 52 min 80% B
 57 min 80% B
 60 min 3% B

Sample: Band from 1D in gel digest

Sample preparation of human serum:
 Major serum proteins removed using Multiple Affinity Removal Column,
 4.6 x 100 mm (p/n 5185-5985)
 Followed by 1D gel digest

Base Peak Chromatogram

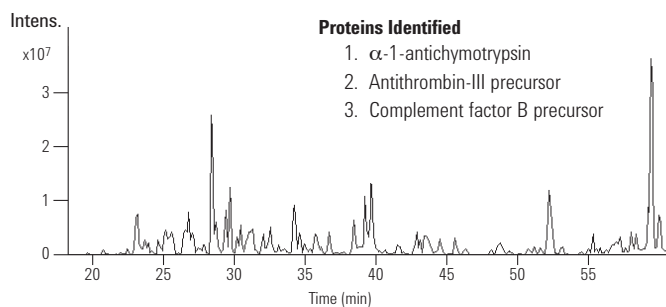

LCBP014

Peptide phosphorylation sites, LC and LC/MS using capillary LC columns

Column: ZORBAX 300SB-C18
5064-8268
0.5 x 150 mm, 3.5 μ m

Mobile Phase: A: Water + 0.1% formic acid
 B: Acetonitrile + 0.1% formic acid

Flow Rate: 5.5 μ L/min

Gradient: 5-55% B in 50 min, to
 85% B from 55-57 min

Detector: UV, 206 nm

MS Conditions: LC/MS: Pos. ion ESI with
 LC/MSD trap
 Vcap: 4,000 V
 Drying gas flow: 7 L/min
 Drying gas
 temperature: 250 $^{\circ}$ C
 Nebulizer: 15 psi
 Capillary exit volt: 50 V max
 Accum time: 300 ms
 Total averages: 3
 Isolation width: 3 m/z
 Frag amplitude: 1.0 V

Sample: Beta case in digest 100 nL (4 pmol)

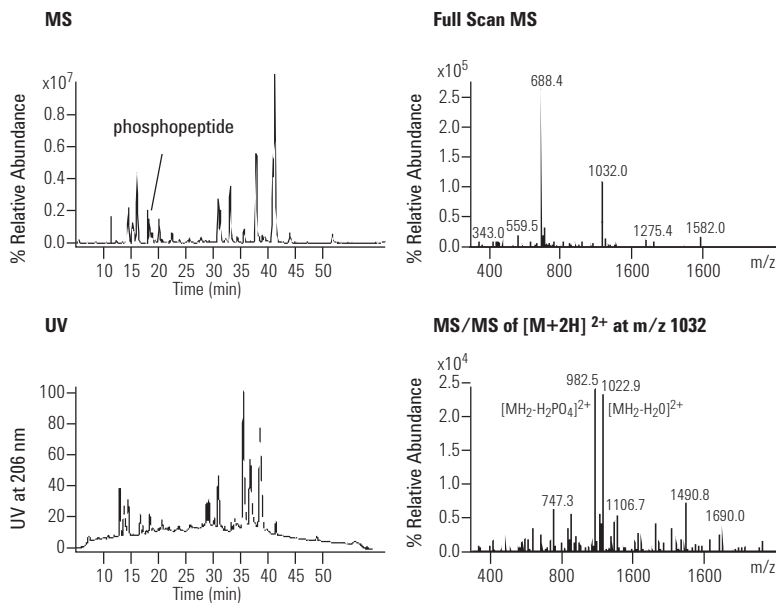

LCBP037

Capillary columns for HPLC analyses with UV and MS detection

Column: ZORBAX 300SB-C18
5064-8263
0.3 x 150 mm, 5 μ m

Mobile Phase: 5-55% B in 50 min, to 85% B from 55-57 min
A: Water + 0.1% formic acid
B: Acetonitrile + 0.1% formic acid

Flow Rate: 5.5 μ L/min

Detector: UV, 206 nm

MS Conditions: LC/MS: Pos. ion ESI with LC/MSD trap,
Vcap 4,000 V
Drying gas flow: 7 L/min
Drying gas temperature: 250 $^{\circ}$ C
Nebulizer: 15 psi
Capillary exit volt: 50 V
Max accum time: 300 ms
Total averages: 3
Isolation width: 3 m/z
Frag amplitude: 1.0 V

Sample: Beta casein digest 100 nL (4 pmol)

A ZORBAX 300SB-C18 capillary column (0.3 mm id) is used for the separation of the protein digest. Detection is by both UV and Electrospray MS. MS detection can be used for identification of peptide fragments.

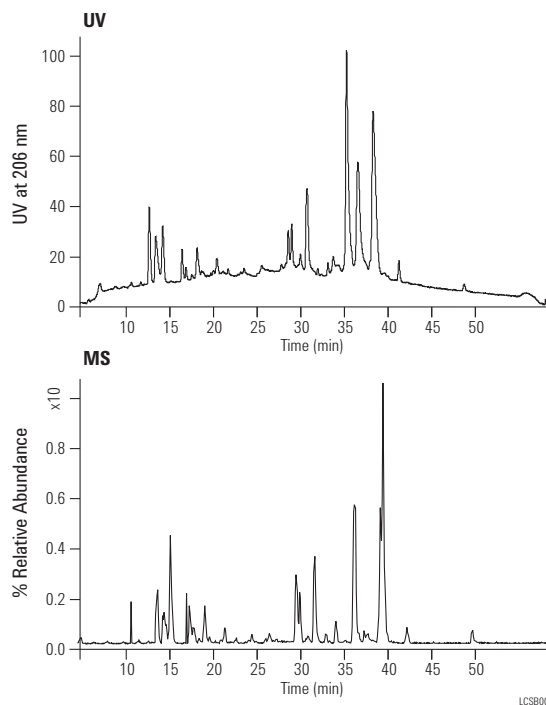

Proteins in a complex sample by 2D HPLC with nano HPLC columns

Column: ZORBAX 300SB-C18
5065-9913
0.3 x 5 mm, 5 μ m

Column: ZORBAX 300SB-C18
5065-9911
0.075 x 150 mm, 3.5 μ m

Mobile Phase: Quaternary pump: 3% acetonitrile:0.1% formic acid
Nanopump: A; water, 0.1% formic acid, B; ACN, 0.1% formic acid

Flow Rate: Quaternary pump: 30 μ L/min
Nanopump: 300 nL/min

Gradient: Quaternary pump: isocratic
Nanopump:
6 min = 3% B, 120 min = 60% B, 125 min = 80% B,
130 min = 80% B, 131 min = 3% B, 140 min = 3% B

MS Conditions: Source: nano ESI, drying gas flow: 5 L/min, drying gas temp: 225 $^{\circ}$ C
Ion trap: skim: 1:35 V, cap exit offset: 115 V, octupole 1:12 V, octupole 2:3.5 V, trap drive: 80 V. ICC: on, averages: 4, max accum time: 150 ms; target 60,000, ion mode positive, MS/MS mode

Sample: Tryptic digest of bovine serum albumin
Volume: 1 to 8 μ L
Salt step elution: 8 mL of 10 mM-100 mM KCl (10 mM increments), 125 mM, 150 mM, 200 mM, 300 mM, 500 mM, 1 M

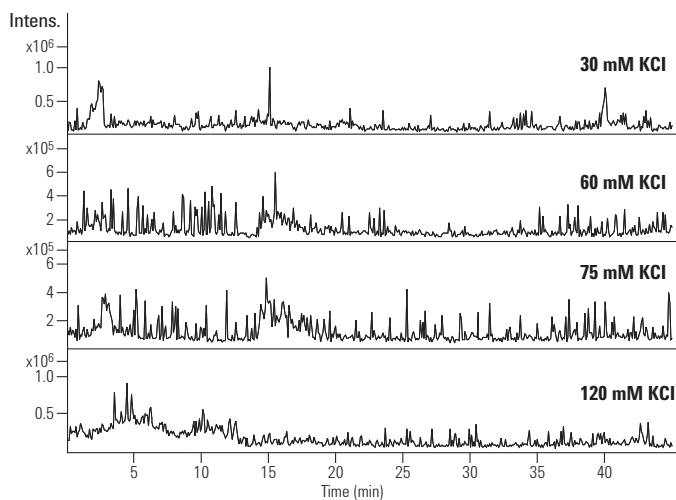

LCCN004

Tryptic digest of bovine serum albumin (BSA). The base peak chromatograms show a selection of fractions from a 2D HPLC separation. Single chromatograms represent peptides from BSA eluting at a given salt concentration followed by enrichment and reversed-phase chromatography.



Nano Columns

ZORBAX Bio-SCX Series II

ZORBAX Bio-SCX Series II columns are designed for optimized 2D separations of peptides and proteins using LC/MS. This packing is based on ultra-pure 3.5 μm ZORBAX silica particles, bonded with a bio-friendly polymer that is functionalized with sulfonic acid groups. This gives strong retention and good peak shape in the ion-exchange step of 2D analysis of peptides and proteins.

HPLC Column Specifications

Bonded Phase	Pore Size	Surface Area	pH Range	Functionality	Max Pressure
ZORBAX Bio-SCX Series II	300Å	90 m ² /g	2.5-8.5	Sulfonic acid	350 bar

More retention of small peptides

Column: ZORBAX Bio-SCX Series II
5065-9912
0.3 x 35 mm, 3.5 μm

Mobile Phase: 95% 40 mM NaCl: 5% ACN,
0.3% formic acid

Flow Rate: 5 $\mu\text{L}/\text{min}$

Detector: UV, 230 nm

Sample: Synthetic dipeptides

The ZORBAX Bio-SCX Series II column retains smaller peptides more strongly than some other SCX columns. The result is increased resolution of more hydrophilic peptide fragments and more accurate identification when these columns are used in 2D HPLC analysis.

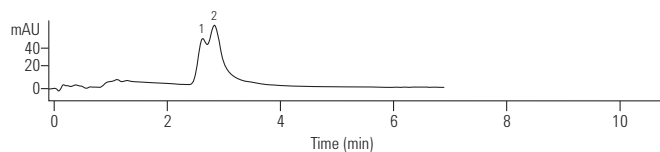
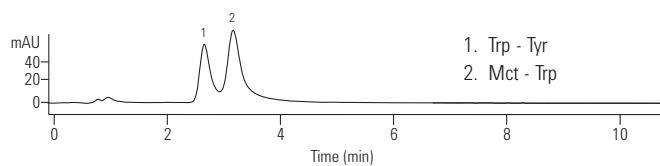

LCIE002

ZORBAX HPLC Capillary Columns (glass-lined stainless steel)

Description	Size (mm)	Particle Size (µm)	Particle Size				Bio-SCX Series II
			300SB-C18	300SB-C8	Poroshell 300SB-C8	300Extend-C18	
Capillary	0.8 x 50	3.5					5065-9942
Capillary	0.5 x 250	5	5064-8266				
Capillary	0.5 x 150	5	5064-8264				
Capillary RR	0.5 x 150	3.5	5064-8268				
Capillary	0.5 x 75	5			5065-4468		
Capillary	0.5 x 35	5	5064-8294				
Capillary RR	0.5 x 35	3.5	5065-4459				
Capillary	0.3 x 250	5	5064-8265				
Capillary	0.3 x 150	5	5064-8263				
Capillary	0.3 x 35	5	5064-8295				
Capillary	0.3 x 35	3.5					5065-9912
Capillary RR	0.3 x 150	3.5	5064-8267	5065-4460		5065-4464	
Capillary RR	0.3 x 100	3.5	5064-8259	5065-4461		5065-4465	
Capillary RR	0.3 x 75	3.5	5064-8270	5065-4462		5065-4466	
Capillary RR	0.3 x 50	3.5	5064-8300	5065-4463		5065-4467	
Replacement Screens, 10/pk			5065-4427	5065-4427	5065-4427	5065-4427	

ZORBAX Nano HPLC Columns (PEEK)

Description	Size (mm)	Particle Size (µm)	Particle Size	
			300SB-C18 USP L1	300SB-C8 USP L7
Nano RR	0.1 x 150	3.5	5065-9910	
Nano RR	0.075 x 150	3.5	5065-9911	
Nano RR	0.075 x 50	3.5	5065-9924	5065-9923
Trap/Guard, 5/pk	0.3 x 5	5	5065-9913	5065-9914
Trap/Guard Hardware kit			5065-9915	5065-9915



ZORBAX 300SB-C18 trap/guard, 5065-9913



Sterically Protected 300StableBond Bonded Phase

MicroBore (1.0 mm id) Columns

- High sensitivity for small sample sizes
- Compatible with LC/MS interfaces
- Wide variety of bonded phases
- Silica and polymeric particles

Agilent MicroBore (1.0 mm id) columns are a good choice when sample sizes are limited. They can improve detection limits five times over 2.1 mm id columns when the same sample mass is used. This increase in sensitivity can be critical. MicroBore columns use low flow rates (typically ~50 $\mu\text{L}/\text{min}$). Therefore, these columns are ideal for use with detectors requiring low flow rates such as some mass spectrometers and with capillary LC systems.

Optimum performance is achieved when MicroBore columns are used with UHPLC/HPLC Microbore systems. A wide variety of bonded phases is available for up to 400 bar including StableBond, 300SB-C18, 300SB-C8, and Poroshell columns. Polymeric reversed-phase, PLRP-S, and ion-exchange PL-SAX and PL-SCX are also available for applications requiring exceptionally stable wide-pore particles. Guard columns are also now available with an adjustable tube depth-stop to provide perfect zero dead volume connection every time.

Separation of a tryptic digest

Column: ZORBAX 300SB-C18
863630-902
1.0 x 150 mm, 3.5 μm

Mobile Phase: Gradient: 2-60% B in 60 min
A: 0.1% TFA
B: 0.075% TFA:80% ACN

Flow Rate: 50 $\mu\text{L}/\text{min}$

Temperature: 50 $^{\circ}\text{C}$

Detector: UV, 215 nm

Sample: Tryptic digest of rhGH 2 μL

This example of a tryptic digest separated on a MicroBore column demonstrates the high sensitivity and resolution possible with 1.0 mm id columns.

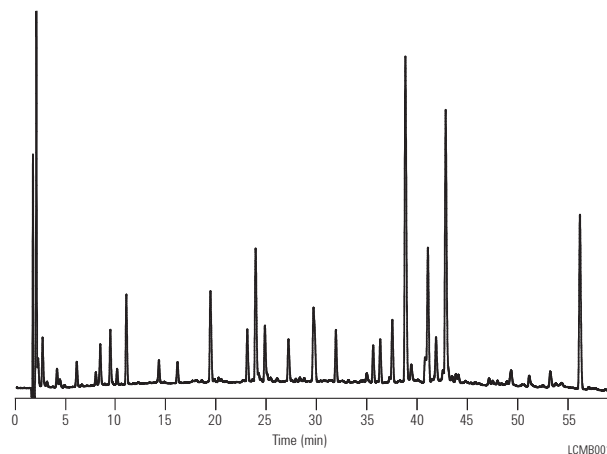

Microbore HPLC for sensitive peptide analysis

Column: PLRP-S 100Å 5 µm, 150 mm x various id

Mobile Phase: A: 0.01 M tris HCl, pH 8
B: A + 0.35 M NaCl, pH 8

Flow Rate: 1 mL/min

Gradient: Linear 20% ACN, 0.1% TFA to 50% ACN, 0.1% TFA over 15 min

Injection Volume: 0.5 µL

Sample Conc: 0.25 mg/mL

Detector: UV, 220 nm

Peptide separation on Agilent PLRP-S 100Å 5 µm columns

Peak Identification

A. 1.0 mm id (flow rate 47 µL/min)

B. 2.1 mm id (flow rate 200 µL/min)

C. 4.6 mm id (flow rate 1 mL/min)

1. Oxytocin
2. Angiotensin II
3. Angiotensin I
4. Insulin

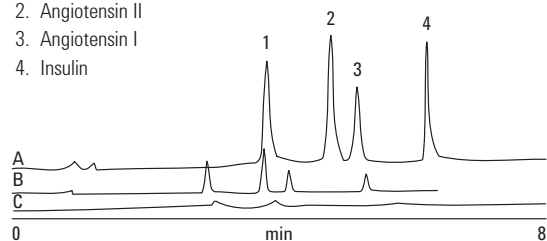

Peak Identification

- ◆ 1.0 mm
- 2.1 mm
- ▲ 4.6 mm

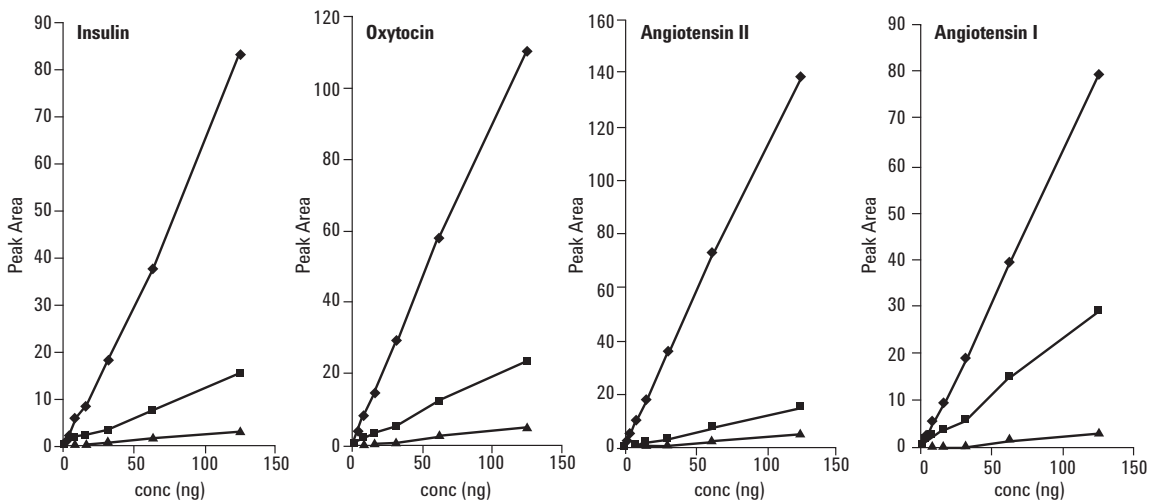

Standard curve data-point graphs on Agilent PLRP-S columns. Reduced column internal diameter reduces the limit of detection and enables quantitation of lower amounts of sample.

MicroBore (1.0 mm id)

Description	Size (mm)	Particle Size (µm)	300SB-C18 USP L1	300SB-C8 USP L7		
MicroBore	1.0 x 250	5	861630-902			
MicroBore RR	1.0 x 150	3.5	863630-902	863630-906		
MicroBore RR	1.0 x 50	3.5	865630-902	865630-906		
MicroBore Guard, 3/pk	1.0 x 17	5	5185-5920	5185-5920		
Description	Size (mm)	Particle Size (µm)	Poroshell 300SB-C18	Poroshell 300SB-C8	Poroshell 300SB-C3	Poroshell 300Extend-C18
MicroBore	1.0 x 75	5	661750-902	661750-906	661750-909	671750-902
MicroBore Guard, 3/pk	1.0 x 17	5	5185-5968	5185-5968	5185-5968	
Description	Size (mm)	Particle Size (µm)	PLRP-S 100Å USP L21	PLRP-S 300Å USP L21	PLRP-S 1000Å USP L21	PLRP-S 4000Å USP L21
MicroBore	1.0 x 150	3	PL1312-3300			
MicroBore	1.0 x 50	8			PL1312-1802	PL1312-1803
MicroBore	1.0 x 50	5	PL1312-1500	PL1312-1501	PL1312-1502	PL1312-1503
MicroBore	1.0 x 50	3	PL1312-1300	PL1312-1301		
Description	Size (mm)	Particle Size (µm)	PL-SAX 1000Å	PL-SAX 4000Å	PL-SCX 1000Å	PL-SCX 4000Å
MicroBore	1.0 x 50	5	PL1351-1502	PL1351-1503	PL1345-1502	PL1345-1503

2D-LC

- Combine two orthogonal LC techniques into a single analysis
- Provides greater peak capacity compared even with UHPLC methods
- Interfaces size exclusion and ion-exchange methods to MS

The heterogeneity and complexity of biomolecules necessitates the use of multiple LC techniques to identify and characterize a target biopharmaceutical. By combining two orthogonal techniques into one analysis, for example hydrophilic interaction and reversed-phase, or cation-exchange and reversed-phase, you can achieve unmatched separating power to enable identification and analysis of critical quality attributes.

Applications for 2D-LC range from simple online desalting of a fraction obtained from a Protein A capture of a monoclonal antibody, to interfacing hydrophilic interaction and reversed-phase peptide mapping methods to characterize the full spectrum of peptide fragments – hydrophilic, glyco-, and hydrophobic peptide fragments.

Achieve increased productivity by using 2D-LC to shorten analysis times and maximize data generation/interpretation:

- Method scouting and application switching
- Offline column regeneration
- Online impurity analysis
- Heart-cutting 2D-LC
- Comprehensive 2D-LC

Offline column regeneration

For robust charge variant analysis using ion-exchange LC, a robust column cleanup and equilibration is required. This adds time to the total analysis and so ways of decreasing this time to increase sample throughput are needed. One way of doing this is to use offline column regeneration, which has been shown to reduce cycle time by as much as 40%.

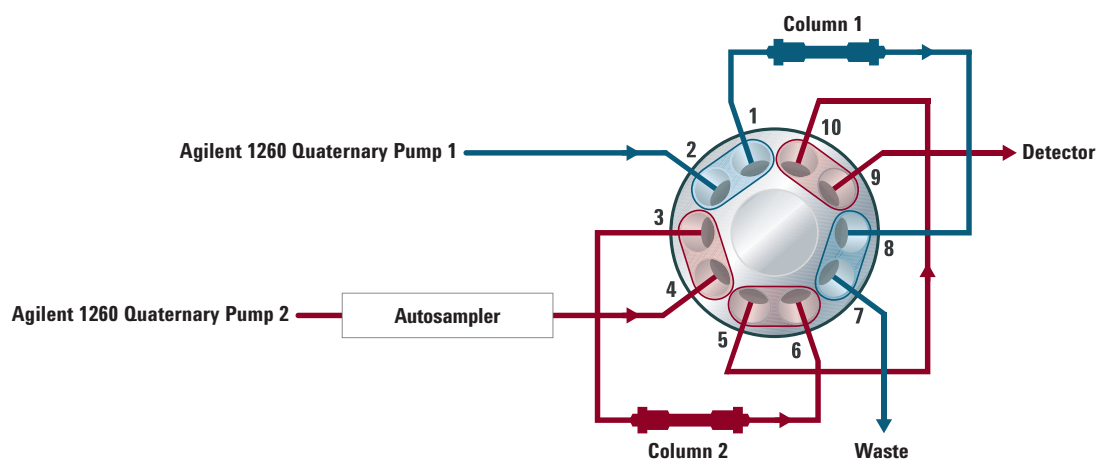

Schematic showing the valve arrangement required for offline column regeneration as would be used for mAb charge variant analysis using the Agilent 1260 Infinity Bio-inert Quaternary LC, and two Agilent Bio MAb PEEK, 2.1 x 250 mm, 5 μ m columns.

Intra- (n = 6) and inter-column (n = 12) precision of retention time and area

	Intra-column % RSD RT	Intra-column % RSD area	Inter-column % RSD RT	Inter-column % RSD area
CV1	0.205	2.50	0.247	3.39
CV2	0.183	1.91	0.218	1.63
CV3	0.247	1.13	0.277	2.56
CV4	0.302	6.73	0.286	6.67
CV5	0.301	1.63	0.255	1.41
CV6	0.252	2.78	0.213	2.93

Good inter- and intra-precision of retention time and area is achieved for the offline regeneration of the Agilent Bio MAb PEEK column. Intra-column (n = 6) and inter-columns (n = 12).

Comprehensive 2D-LC

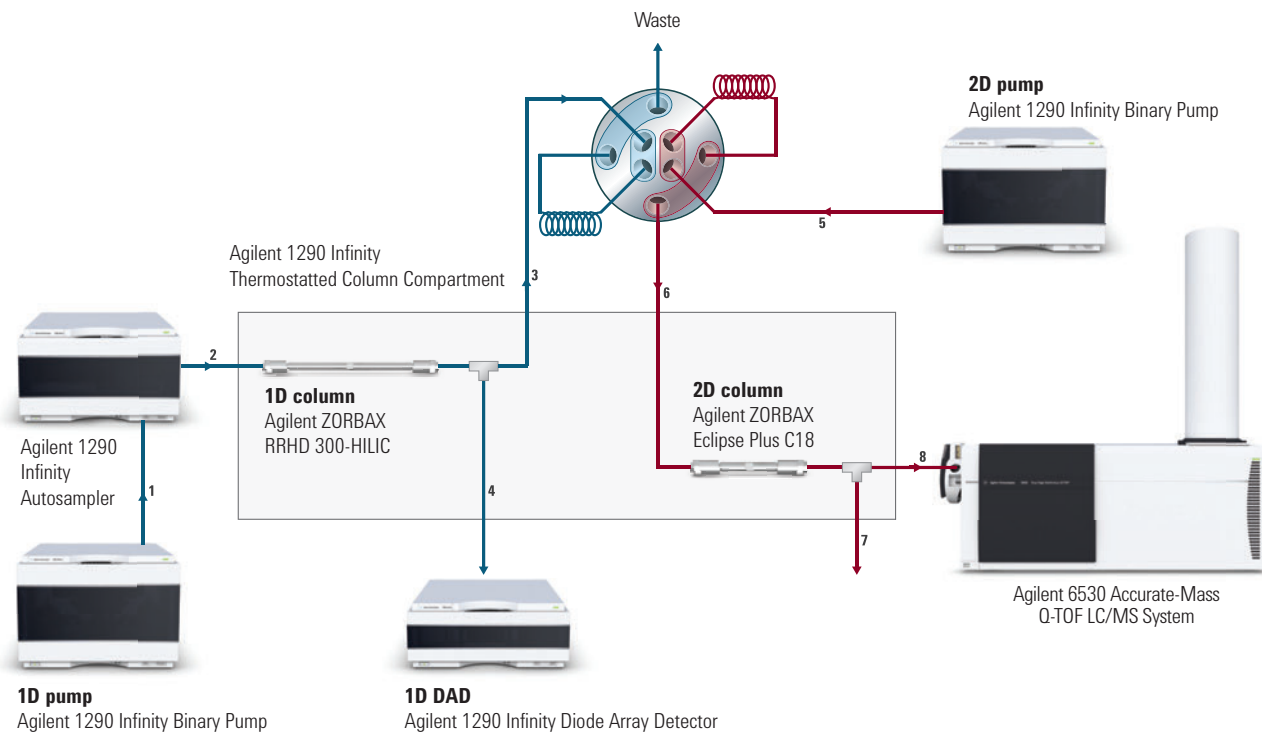

1	1D pump to autosampler	Calibration capillary (G1312-67500)
2	Autosampler to 1D column (1.6 μ L heat exchanger)	SS, 0.17 mm
3	Tee 1 to 2D-LC valve	SS, 0.12 x 200 mm
4	Tee 1 to 1D DAD	SS, 0.12 x 140 mm
5	2D pump to 2D-LC valve	SS, 0.17 mm
6	2D-LC valve to 2D column (1.6 μ L heat exchanger)	SS, 0.12 x 270 mm
7	Tee 2 to waste	SS, 0.12 x 340 mm
8	Tee 2 to detector (AJS source or DAD 2D)	SS, 0.075 x 340 mm (5067-4783)

System configuration for comprehensive 2D analysis of monoclonal antibody digests, and peptide mapping, using HILIC and RPLC-MS.

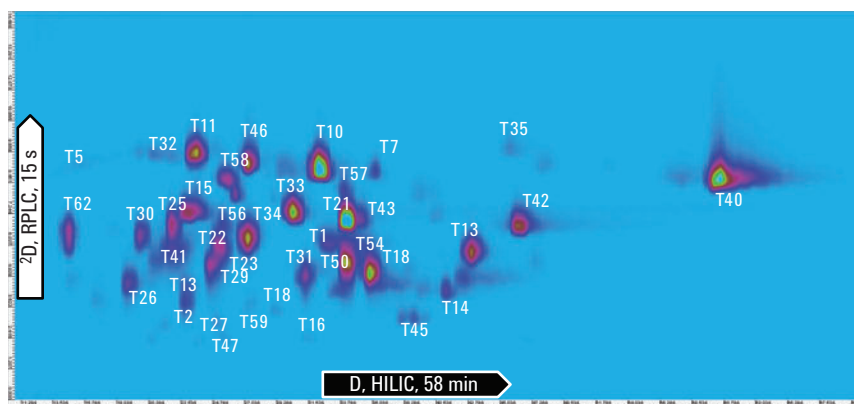

LCxLC contour plot for the analysis of the tryptic digest of trastuzumab generated with MS total ion count data. The two dimensions, HILIC in the first and RP in the second, had good orthogonality for this analysis.

Column sizes used for 2D-LC are typically those defined as capillary, nano, or microbore (0.075 to 1 mm id). Agilent has a wide range of phases available in these column sizes. If you cannot find the combination of pore size, particle size, phase, and column size you require, contact our custom columns team who have a wealth of expertise in producing columns to meet specific performance criteria.

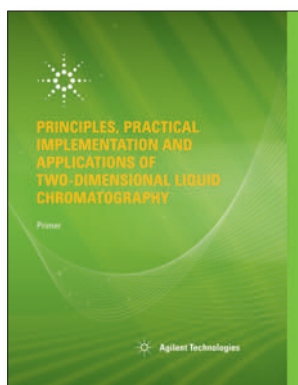

TIPS & TOOLS

To find out more about the fundamentals of 2D-LC, order a copy of our 2D-LC primer:

Principles, Practical Implementation and Applications of Two-Dimensional Liquid Chromatography (publication 5991-2359EN)

www.agilent.com/chem/2DLC-Primer



Polymeric Prep HPLC Columns

Purification – Prep HPLC

Agilent has a comprehensive range of silica and polymeric HPLC columns and media designed for biomolecule purification. There are high efficiency small particle prep columns optimized for the purification of μg and mg amounts of a biopharmaceutical drug candidate, and fully porous bulk media, to pack development and process columns to purify g , kg , and multi- kg of API.

Some columns are specifically designed to address the needs of high efficiency purification, while other products provide easy scale-up from small particle analytical columns to full-scale API production. **Table 1** shows prep column/media options and the quantity of product that can be purified.

TIPS & TOOLS

Information on the different types of prep chromatography can be found in:

Principles and Practical Aspects of Preparative Liquid Chromatography
(publication 5991-2358EN)

www.agilent.com/chem/library

Biopharmaceutical Lifecycle		Discovery		Development g	Production	
		μg high efficiency	mg		kg	multi-kg high throughput
Reversed-phase	mRP-C18	→				
	ZORBAX Prep HT 300Å StableBond	→	→			
	VariTide RPC	→	→	→		
	PLRP-S 100Å, 300Å, 1000Å, 4000Å	→	→	→	→	→
Ion-exchange	Agilent Bio MAb	→	→	→		
	Agilent Bio IEX	→	→	→		
	PL-SAX	→	→	→	→	→
	PL-SCX	→	→	→	→	→
Size exclusion	Agilent Bio SEC-3	→	→	→		
	Agilent Bio SEC-5	→	→	→		

Table 1: Agilent columns and media for biomolecule purification – chromatographic type, product family, and purification scale.

Purification Column Selection			
Application	Technique	Notes	Agilent Columns
Proteomics	Reversed-phase	A specialist high recovery column for proteomics applications. It is designed for µg scale purification with maximum recovery.	mRP-C18
All biomolecules	Reversed-phase	High efficiency 300Å silica-based particles.	ZORBAX PrepHT 300SB
Synthetic peptides	Reversed-phase	Polymeric material designed for the purification of synthetic peptides. It is a high efficiency single-column solution for the full range of synthetic peptides, acidic, basic, hydrophobic, and hydrophilic, and covers the size range of peptides produced by both solution and solid phase synthesis.	VariTide RPC
All biomolecules	Reversed-phase	The premium polymeric reversed-phase family with a range of pore sizes and particle sizes to enable high efficiency laboratory scale purification using small particle prep columns, and scale-up to high yield production purification with larger particles at the process scale. Use PLRP-S when purification will be scaled up to produce APIs and will need regulatory documentation. <ul style="list-style-type: none"> • 3 µm and 5 µm for high efficiency • 8 µm, 10 µm, 10-15 µm, 15-20 µm, 30 µm, and 50 µm particles for larger scale and low pressure purification 	PLRP-S
Monoclonal antibodies	Ion-exchange	A nonporous weak cation-exchanger	Agilent Bio MAb
All biomolecules	Ion-exchange	Nonporous ion-exchangers <ul style="list-style-type: none"> • SAX, WAX, SCX, and WCX functionalities to provide options for purification of acidic and basic molecules • Nonporous 5 µm particle for highest efficiency lab prep 	Agilent Bio IEX
All biomolecules	Ion-exchange	A fully porous strong anion-exchanger <ul style="list-style-type: none"> • 5 µm particle size for high efficiency separations • 8 µm, 10 µm, and 30 µm particles for larger scale medium and low pressure purification 	PL-SAX
		A fully porous strong cation-exchanger <ul style="list-style-type: none"> • 5 µm particle size for high efficiency separations • 8 µm, 10 µm, and 30 µm particles for larger scale medium and low pressure purification 	PL-SCX
All biomolecules	Size exclusion	Silica based SEC materials with a range of pore sizes <ul style="list-style-type: none"> • 3 µm, and 5 µm particle sizes for high efficiency • Pore sizes for 100Å to 2000Å cover a wide range of sample molecular sizes 	Agilent Bio SEC-3 and 5

TIPS & TOOLS

Further information can be found in:

Biomolecule Purification (publication 5990-8335EN)

www.agilent.com/chem/library



mRP-C18 High-Recovery Protein Column,
4.6 x 50 mm, 5188-5231

mRP-C18 High-Recovery Protein Columns

The mRP (macroporous reversed-phase) C18 High-Recovery Protein column is designed for high recovery, high resolution separation, fractionation, and simultaneous desalting of complex protein samples such as immunodepleted serum or plasma proteins.

- Greater than 95-99% protein sample recovery has been observed with immunodepleted serum using the Agilent Multiple Affinity Removal System – LC column
- Can load up to 380 µg of total protein mass without reducing chromatographic resolution of the proteins
- Column packed with macroporous C18-bonded ultra pure 5 µm particle silica designed to reduce or eliminate strong adsorption of proteins
- Maximum operating pressure of 250 bar (4,000 psi)
- Compatible with water and all common organic solvents

mRP-C18 High-Recovery Protein Columns

Description	Protein Load Capacity	Part No.
mRP-C18, 0.5 x 100 mm	10 ng-5 µg	5188-6510
mRP-C18, 2.1 x 75 mm	8-85 µg	5188-6511
mRP-C18, 4.6 x 50 mm	40-380 µg	5188-5231

Protein Fractionation of Complex Samples on the mRP Column

mRP-C18, 4.6 x 50 mm

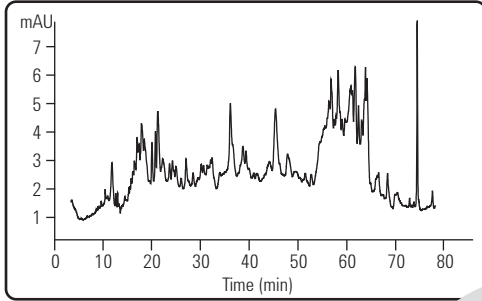

HeLa Membrane Prep

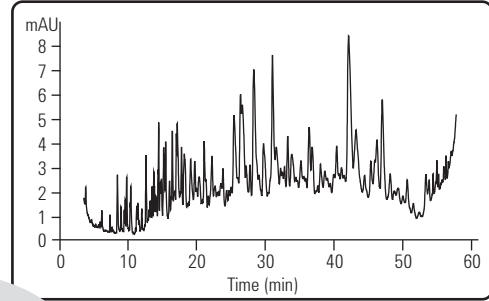

HeLa Cell Lysate (352 µg)

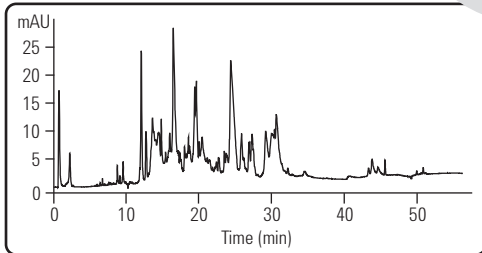

"Top-6" Depleted Human Serum

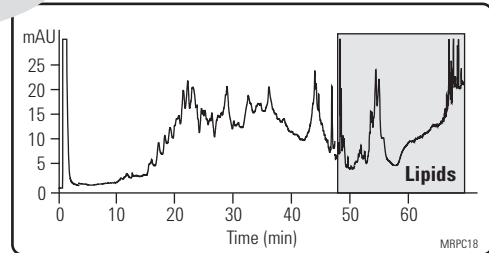

Human Brain Membrane Lipid Raft Prep (500 µg)

Highest Recovery



ZORBAX 300Å StableBond
Prep HT Cartridge Columns

ZORBAX PrepHT

- Easy scale-up from analytical to preparative scale with ZORBAX phases
- Fast preparative separations, up to 2,000 mg
- 5 to 7 μm particles for high efficiency and high yield
- Easy to install finger-tight connections seal up to 5,000 psi/350 bar
- Use to maintain selectivity of the analytical phase in your prep separations

High purity, high recovery, and high throughput can be easily achieved with Agilent ZORBAX PrepHT columns. Available in a variety of bonded phases – StableBond 300Å, C18, C8, C3, and CN – for optimized resolution and loadability under any conditions.

ZORBAX PrepHT columns are packed with 5 and 7 μm particle sizes for very high resolution. The high resolution allows high loadability, high yield, and high purity of compounds. The larger diameter columns and mechanically stronger ZORBAX particles allow for flow rates up to 100 mL/min, thus increasing throughput.

ZORBAX PrepHT columns are designed for rapid scale-up from analytical to preparative scale without losing resolution. For complex separations on larger columns (21.2 mm id, 150 mm length and longer), Agilent has carefully chosen the 7 μm particle size to achieve a balance between high efficiency and high loadability.

ZORBAX 300Å StableBond

Hardware	Description	Size (mm)	Particle Size (μm)	300SB-C18 USP L1	300SB-C8 USP L7	300SB-CN USP L10	300SB-C3 USP L56
PrepHT Cartridge Columns (require endfittings kit 820400-901)							
	PrepHT Cartridge	21.2 x 250	7	897250-102	897250-106	897250-105	897250-109
	PrepHT Cartridge	21.2 x 150	7	897150-102	897150-106		897150-109
	PrepHT Cartridge	21.2 x 150	5	895150-902	895150-906		895150-909
	PrepHT Cartridge	21.2 x 100	5	895100-902	895100-906		895100-909
	PrepHT Cartridge	21.2 x 50	5	895050-902	895050-906		895050-909
	PrepHT Endfittings, 2/pk			820400-901	820400-901	820400-901	820400-901
	PrepHT Guard Cartridge, 2/pk	17.0 x 7.5	5	820212-921	820212-918	820212-924	820212-924
	Guard Cartridge Hardware			820444-901	820444-901	820444-901	820444-901

Semi-preparative RP-HPLC of PEG lysozyme reaction mixture

Column: **ZORBAX SB-C18**
880975-202
9.4 x 250 mm, 5 μ m

A: Semi-preparative RP-HPLC of PEG lysozyme reaction mixture on an Agilent ZORBAX Semi-preparative 300 SB-C18 column

B: Zoom-in showing fraction collection

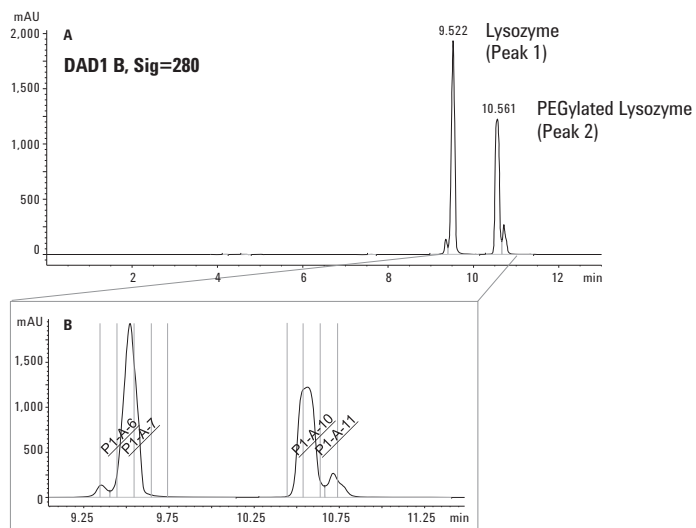



PLRP-S for Prep to Process

- Discovery stage to multi-kg cGMP production reduces method development time
- Chemical stability for separations, optimization, sanitation, and regeneration increases selectivity and column lifetime
- Single batch packing of multiple columns reduces system downtime and validation costs

The PLRP-S media, rigid poly(styrene/divinylbenzene) particles, are available in a range of pore sizes for small molecule, synthetic biomolecule, and macromolecule purification. Their thermal and chemical stability makes them ideal for purifications that require extreme conditions for sample preparation, compound elution, and column regeneration.

Capacity and resolution are two key parameters for maximizing the throughput of a purification. With a wide choice of pore sizes and extended range of operating conditions, PLRP-S provides more options to achieve the optimum process. Particle sizes range from 3 μm to 50 μm for scale-up from the $\mu\text{g}/\text{mg}$ discovery stage to multi-kg cGMP production. Excellent chemical stability, up to 1 M NaOH, permits sanitation and regeneration that increase column lifetime. PLRP-S media batch sizes of up to 600 L are available, providing single batch packing of multiple columns.

As part of our commitment to quality and continuity of supply, all manufacturing is carried out under a fully documented process, and facility audits are routinely conducted.



PLRP-S Prep to Process Application Guide

Application	PLRP-S Media Pore Size			
	100Å	300Å	1000Å	4000Å
Synthetic biomolecules, peptides, oligonucleotides	✓	✓		
Recombinant biomolecules, peptides, proteins	✓	✓		
Large biomolecules, antibodies, DNA fragments			✓	✓
Small molecules, unstable compounds including metal sensitivity	✓			

UHPLC Column Specifications

pH range	1-14
Buffer content	Unlimited
Organic modifier	1-100%
Temperature limits	200 °C
Maximum pressure	5-8 µm: 3,000 psi (210 bar)
	3 µm: 4,000 psi (300 bar)

Purification of a 25-mer trityl-off oligonucleotide and analytical quantitation of the fraction using PLRP-S 100Å, 4.6 x 50 mm

Column: PLRP-S 100Å
PL1512-1300
4.6 x 50 mm, 3 µm

Mobile Phase: A: 100 mM Triethylammonium acetate (TEAA)
B: 100 mM TEAA in 25:75 Acetonitrile:water

Flow Rate: 1 mL/min

Gradient: 25% B 0 min, 35% B 2 min, 45% B 22.5 min, 45% B 23 min, 25% B 23.05 min, 25% B 26 min

Temperature: 80 °C

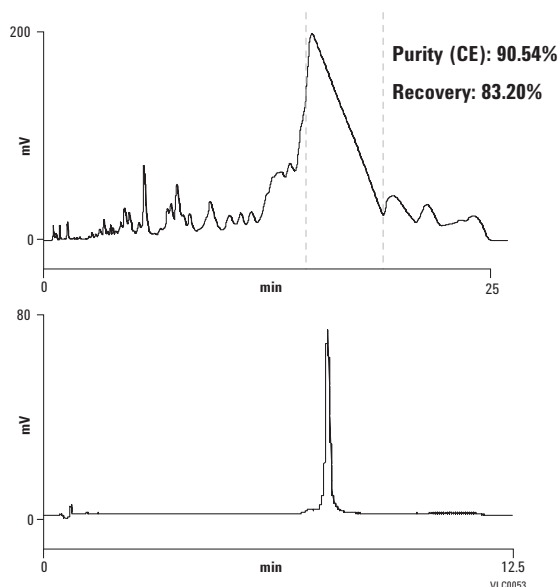

Crude bradykinin prep load

Column: PLRP-S 100Å
PL1512-5100
4.6 x 250 mm, 10 µm

Sample: 30 µL containing 1.5 mg of crude peptide

Mobile Phase: 0.1% TFA in 21% ACN:79% water

Flow Rate: 1 mL/min (360 cm/h)

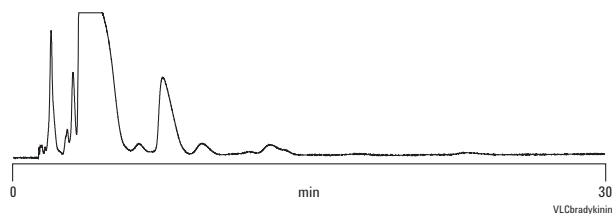

Fraction analysis – the concentration overload purification

HPLC analysis of the fractions collected across the peak showed that fractions 1 to 4 contained only the peptide of interest and that the level of the critical impurity increased with increasing fraction number. Using the high efficiency PLRP-S column it was possible to obtain from the crude, 91.7% pure, a recovery of 97% with 100% purity. For more information, see application note 5990-7736EN.

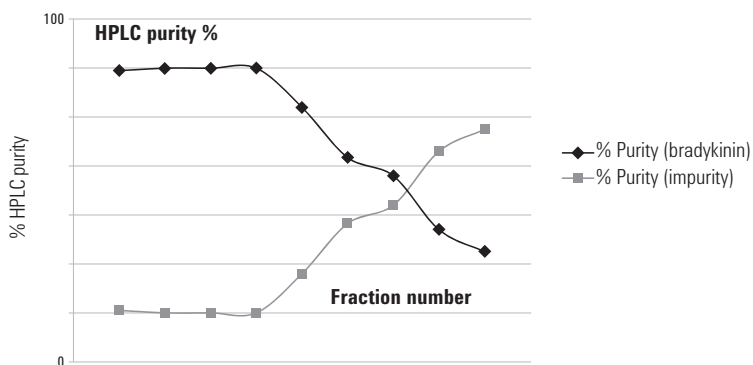

Prep to Process PLRP-S

Size (mm)	Particle Size (µm)	PLRP-S 100Å	PLRP-S 300Å	PLRP-S 1000Å	PLRP-S 4000Å
100 x 300	30			PL1812-3102	PL1812-3103
100 x 300	15-20	PL1812-6200	PL1812-6201		
100 x 300	10-15	PL1812-6400	PL1812-6401		
100 x 300	10	PL1812-6100	PL1812-6101		
100 x 300	8	PL1812-6800	PL1812-6801		
50 x 300	8	PL1712-6800	PL1712-6801		
50 x 150	30			PL1712-3702	PL1712-3703
50 x 150	15-20	PL1712-3200	PL1712-3201		
50 x 150	10-15	PL1712-3400	PL1712-3401		
50 x 150	10	PL1712-3100	PL1712-3101	PL1712-3102	PL1712-3103
50 x 150	8	PL1712-3800	PL1712-3801		
25 x 300	15-20	PL1212-6200	PL1212-6201		
25 x 300	10-15	PL1212-6400	PL1212-6401		
25 x 300	10	PL1212-6100	PL1212-6101		
25 x 300	8	PL1212-6800	PL1212-6801		
25 x 150	30			PL1212-3702	PL1212-3703
25 x 150	10	PL1212-3100	PL1212-3101	PL1712-3102	PL1712-3103
25 x 150	8	PL1212-3800	PL1212-3801		
25 x 50	10			PL1212-1102	PL1212-1103
PLRP-S Method Development Columns					
4.6 x 250	30			PL1512-5702	PL1512-5703
4.6 x 250	15-20	PL1512-5200	PL1512-5201		
4.6 x 250	10-15	PL1512-5400	PL1512-5401		
4.6 x 250	10	PL1512-5100	PL1512-5101	PL1512-5102	PL1512-5103
4.6 x 250	8	PL1512-5800	PL1512-5801		
4.6 x 150	30			PL1512-3702	PL1512-3703
4.6 x 150	15-20	PL1512-3200	PL1512-3201		
4.6 x 150	10-15		PL1512-3401		
4.6 x 150	10	PL1512-3100	PL1512-3101	PL1512-3102	PL1512-3103
4.6 x 150	8	PL1512-3800	PL1512-3801		

PLRP-S Bulk Media

Particle Size (µm)	Unit	PLRP-S 100Å	PLRP-S 300Å	PLRP-S 1000Å	PLRP-S 4000Å
50	1 kg	PL1412-6K00	PL1412-6K01	PL1412-6K02	
	100 g	PL1412-4K00	PL1412-4K01	PL1412-4K02	
30	100 g			PL1412-4702	PL1412-4703
15-20	1 kg	PL1412-6200	PL1412-6201		
	100 g	PL1412-4200	PL1412-4201		
10-15	1 kg	PL1412-6400	PL1412-6401		
	100 g	PL1412-4400	PL1412-4401		
10	1 kg	PL1412-6100	PL1412-6101		
	100 g	PL1412-4100	PL1412-4101	PL1412-4102	PL1412-4103
8	1 kg	PL1412-6800	PL1412-6801		

Custom column and bulk media ordering.

If you do not see the combination of pore size/particle size and column dimension or the bulk media quantity you require in these tables, please contact your local sales office for assistance with our custom ordering process.

Bio MAb particle

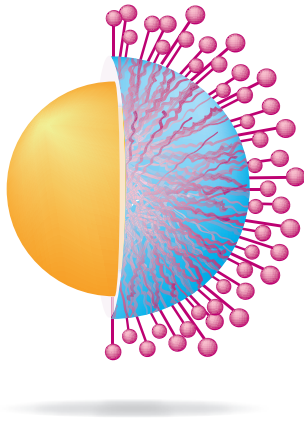

Bio IEX particle

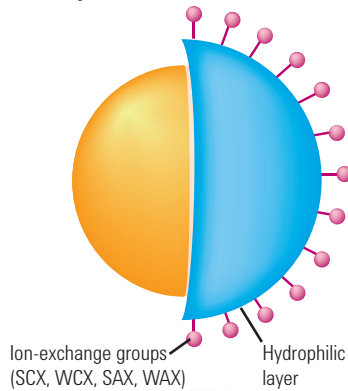

Agilent Bio MAb and Agilent Bio IEX

Analytical to high efficiency prep

- Nonporous particle to eliminate mass transfer and provide highest efficiency to purify even closely related impurities
- Five functionalities: SAX, WAX, SCX, WCX, and a CX optimized specifically for mAbs to provide maximum resolution for increased sample load
- Scale-up from analytical to semi-prep and prep with the same 5 μm particle

The outer hydrophilic layer on these particles reduces nonspecific interaction and delivers high sample recovery.

With analytical, semi-prep, and prep columns packed with the same 5 μm particles, any unexpected charge variant seen during process development of a biopharmaceutical can quickly be purified for further characterization and identification.

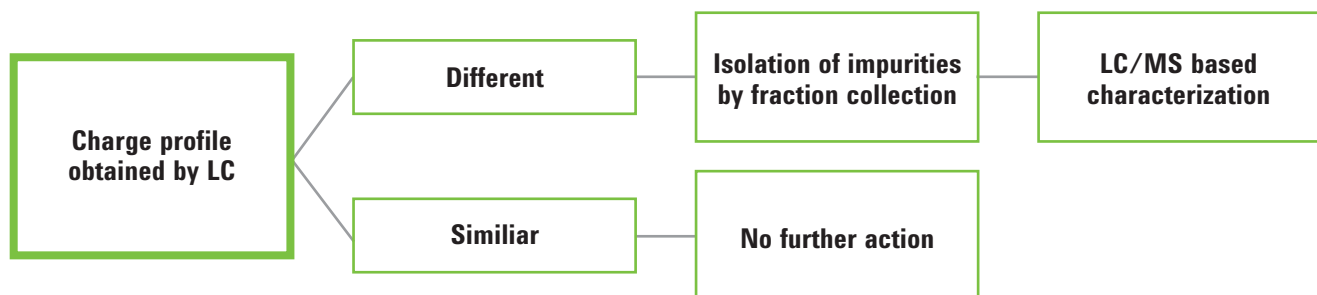

Agilent Bio MAb HPLC Columns

Size (mm)	Particle Size (μm)	Part No.
21.2 x 250	5	5190-6885
10 x 250	5	5190-6884

Agilent Bio IEX HPLC Columns, Stainless Steel

Size (mm)	Particle Size (μm)	Bio SCX Part No.	Bio WCX Part No.	Bio SAX Part No.	Bio WAX Part No.
21.2 x 250	5	5190-6879	5190-6881	5190-6883	5190-6877
10 x 250	5	5190-6878	5190-6880	5190-6882	5190-6878



PL-SAX and PL-SCX for Prep to Process

- Ion-exchange purifications over a wider pH range extend applications
- HPLC flow rates and rapid equilibration reduce purification cycle times
- Large pore size for improved mass transfer delivers high speed, high resolution purifications

These rigid, strong ion-exchange materials are extremely hydrophilic and are designed for purification of biomolecules. The PL-SAX and PL-SCX materials are totally polymeric and are chemically and thermally stable over a full range of HPLC conditions. The strong ion-exchange functionalities, covalently linked to a chemically stable polymer, facilitate ion-exchange purifications over a wider pH range. This stability can be exploited for column sanitation and clean-up. Thermal stability also enables the use of denaturing conditions and stabilizing/solubilizing agents for the purification of target compounds, as encountered in the purification of synthetic oligonucleotides with self-complementary sequences.

Both the 1000Å and 4000Å wide-pore materials are mechanically stable and robust and can be operated over a wide range of linear velocities, with fast loading of dilute solutions and wash cycles. HPLC flow rates, and rapid equilibration reduce purification cycle times.

Packing in dynamic axial compression (DAC) column hardware is straightforward and high efficiency columns are achieved with excellent reproducibility and lifetimes. The 1000Å pore size is for high-capacity purifications and the 4000Å gigaporous particles with improved mass transfer are intended for large biomolecules and high speed, high resolution purifications.



Column Specifications

	PL-SAX	PL-SCX
Matrix	Fully polymeric	Fully polymeric
Pore sizes	1000Å, 4000Å	1000Å, 4000Å
Particle sizes	10 µm, 30 µm	10 µm, 30 µm
Bead form	Rigid spherical	Rigid spherical
Functionality	Quaternary amine	Sulfonic acid
Pressure stability	3,000 psi	3,000 psi
Temperature stability	80 °C	80 °C
pH range	1-14	1-14
Eluent compatibility	All anion-exchange buffers	All cation-exchange buffers
Packed bed density	0.39 g/mL	0.39 g/mL

Purification of a large oligonucleotide

Column: PL-SAX 1000Å, 8 µm

Mobile Phase: A: 93% 100 mM TEAA, pH 7.7% ACN
B: 93% 100 mM TEAA, 3.24 M ammonium acetate, pH 7.7% ACN

Gradient: 0-100% B in 20 min

Flow Rate: 1.5 mL/min

Temperature: 60 °C

Detector: UV, 290 nm

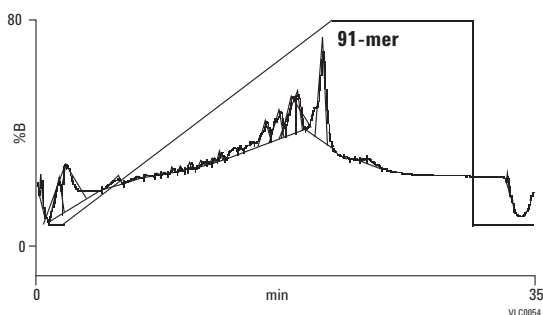

Preparative fractionation of a culture filtrate containing amyloglucosidases

Column: PL-SAX 4000Å
PL1551-1803
4.6 x 50 mm, 8 µm

Mobile Phase: A: 10 mM tris HCl, pH 8
B: A + 500 mM NaCl, pH 8

Flow Rate: 4.0 mL/min

Gradient: Linear 0-100% B in 2 min

Detector: UV, 280 nm

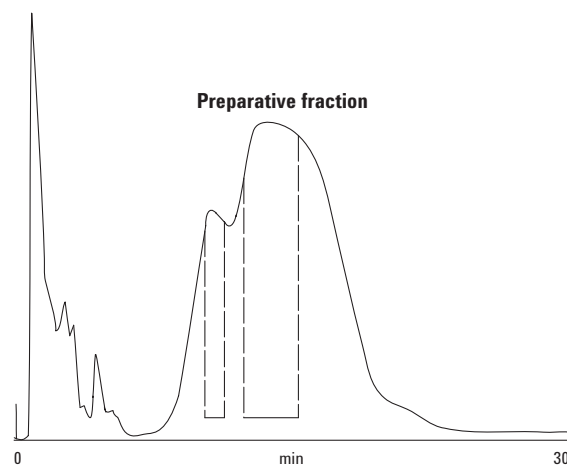



Prep to Process PL-SAX and PL-SCX Columns
and Bulk Media

Prep to Process PL-SAX and PL-SCX

Dimensions	Particle Size (μm)	PL-SAX 1000Å	PL-SAX 4000Å	PL-SCX 1000Å	PL-SCX 4000Å
50 x 150	30	PL1751-3702	PL1751-3703	PL1745-3702	PL1745-3703
50 x 150	10	PL1751-3102	PL1751-3103	PL1745-3102	PL1745-3103
25 x 150	30	PL1251-3702	PL1251-3703	PL1245-3702	PL1245-3703
25 x 150	10	PL1251-3102	PL1251-3103	PL1245-3102	PL1245-3103
25 x 50	10	PL1251-1102	PL1251-1103	PL1245-1102	PL1245-1103
7.5 x 150	8	PL1151-3802	PL1151-3803		
7.5 x 50	8	PL1151-1802	PL1151-1803	PL1145-1802	PL1145-1803

PL-SAX and PL-SCX Method Development Columns

4.6 x 250	30	PL1551-5702	PL1551-5703	PL1545-5702	PL1545-5703
4.6 x 250	10	PL1551-5102	PL1551-5103	PL1545-5102	PL1545-5103
4.6 x 150	30	PL1551-3702	PL1551-3703	PL1545-3702	PL1545-3703
4.6 x 150	10	PL1551-3102	PL1551-3103	PL1545-3102	PL1545-3103

PL-SAX and PL-SCX Bulk Media

Particle Size (μm)	Unit	PL-SAX 1000Å	PL-SAX 4000Å	PL-SCX 1000Å	PL-SCX 4000Å
30	100 g	PL1451-4702	PL1451-4703	PL1445-4702	PL1445-4703
10	100 g	PL1451-4102	PL1451-4103	PL1445-4102	PL1445-4103

Custom column and bulk media ordering.

If you do not see the combination of pore size/particle size and column dimension or the bulk media quantity you require in these tables, please contact your local sales office for assistance with our custom ordering process.



VariTide RPC Columns

Peptide Purification

VariTide is a cost-effective solution for the production of synthetic peptides. This column lets you manage the cost and efficiency of high-volume synthetic peptide purification, from μg to g scale. VariTide provides a solution for peptide houses that manufacture small quantities of hundreds or thousands of peptides where manufacturing time is the economic driving force.

VariTide RPC Columns for Synthetic Peptides

- A single column to cover the full range of synthetic peptides
- Small particle size for maximum efficiency, even with 1 and 2 in prep columns
- Bulk media to pack 1 and 2 in prep columns for the purification of mg to g quantities

VariTide RPC columns and media are part of the VariPep Peptide Solution. This is the recommended option for cost-effective separation and purification of synthetic peptides using generic methods.

VariTide RPC Columns for Synthetic Peptides

Size (mm)	Part No.
21.2 x 250	PL1E12-5A05
10.0 x 250	PL1012-5A05
4.6 x 250	PL1512-5A05

VariTide RPC Bulk Media

Description	Part No.
100 g	PL1412-4A05
1 kg	PL1412-6A05

Crude peptide screen

Column: VariTide RPC
PL1512-5A05
4.6 x 250 mm

Mobile Phase: Acidic
A: 0.1% TFA in 95% water: 5% ACN
B: 0.1% TFA in 50% water: 50% ACN
Basic
A: 5% ACN, 95% 20 mM ammonium carbonate, pH 9.5
B: 50% ACN, 50% 20 mM ammonium carbonate, pH 9.5

Flow Rate: 1.0 mL/min (360 cm/h)

Gradient: 0-100% B in 30 min

Detector: UV, 220 nm

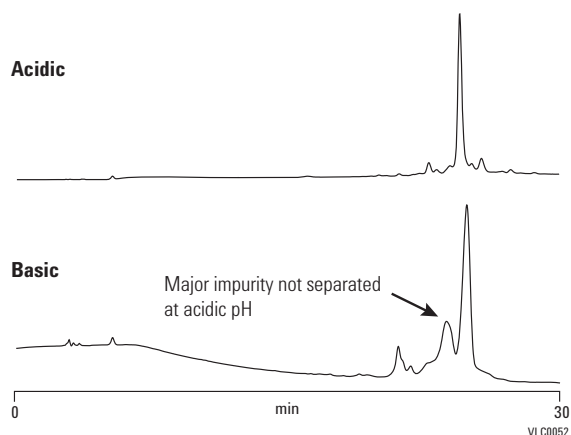
**VariPure IPE**

- Prepacked for convenience
- Removal of ion-pairing agents for improved productivity
- High performance and economy for excellent efficiency

VariPure IPE is a polymer-supported quaternary-amine resin with a bicarbonate counter ion, designed for removing acidic ion-pair reagents, such as trifluoroacetic acid (TFA), formic acid, or acetic acid. VariPure IPE is a high performance and economical acid-removal material conveniently supplied as prepacked SPE type devices. The particle size, capacity, and device geometry are matched to provide sufficient residence time to achieve effective ion-air extraction under gravity flow. For acid-labile peptides, removal of the ion-pairing agent prevents acid degradation of the peptide during post-HPLC work-up, and increases the yield of purified product.

VariPure IPE

Loading	Counter-ion Removal Capacity	Unit	Part No.
100 mg per 3 mL tube	~5 mL 0.1% TFA	50/pk	PL3540-D603VP
500 mg per 6 mL tube	~25 mL 0.1% TFA	50/pk	PL3540-C603VP
1 g per 20 mL tube	~50 mL 0.1% TFA	25/pk	PL3540-P603VP
25 g			PL3549-3603VP



Load & Lock Preparative HPLC Column Packing Systems

Agilent offers a complete range of Load & Lock column systems for laboratory preparative LC. They are designed to let you easily and quickly pack your own preparative high efficiency columns. This is the right solution for development applications of pharmaceutical compounds, peptides, and natural products. Our Load & Lock columns have a unique fluid/sample distribution system to maximize productivity. The system provides dynamic axial compression (DAC) and static "locked" axial compression (SAC) and is designed for easy operation to deliver greater convenience.

Laboratory Load & Lock Columns

- Mobile packing station supports three different column sizes
- Runs on compressed air with no need for a power supply
- Quick and easy packing and unpacking within minutes

Agilent's laboratory scale Load & Lock columns combine excellent packed-bed stability with enhanced flow distribution to deliver the highest quality purification possible with maximum speed, flexibility, and ease of operation. Three different column sizes are supported; 1 in, 2 in, and 3 in id. Because the station is powered by compressed air, it is the perfect solution for hazardous environments. The quick-release single-bolt clamp offers speedy and easy packing and unpacking within minutes.

Load & Lock Preparative HPLC Column Packing Systems

Description	Water Jacket	Size (mm)	Part No.
Load & Lock 4001 Column	No	27.0 x 500	PCG93LL500X25
	Yes	27.0 x 500	PCG93LL500X25WJ
	Spare parts kit		PCG931AAKIT
Load & Lock 4002 Column	No	50.0 x 500	PCG93LL500X50
	Yes	50.0 x 500	PCG93LL500X50WJ
	Spare parts kit		PCG932AAKIT
Load & Lock 4003 Column	No	75.0 x 500	PCG93LL500X75
	Yes	75.0 x 500	PCG93LL500X75WJ
	Spare parts kit		PCG933AAKIT
Mobile packing station (air-driven hydraulic)			PCG93LLSTAND123

Agilent Bio SEC

Purification based on size

- Six pore sizes to provide size separations across the range of biopharmaceuticals
- Scale-up from 3 μm , and 5 μm analytical columns to lab prep with the same particles
- The thin hydrophilic polymer layer minimizes nonspecific interactions and provides good peak shapes and increased sample capacity

These silica based SEC materials have optimized pore sizes and pore volume to provide high resolution separations under HPLC conditions of pressure and flow rate.

The 3 μm particles with 100 \AA , 150 \AA , and 300 \AA pore sizes provide highest efficiency for lab prep, and the 5 μm particles provide a wide range of pore sizes for fractionation of larger biomolecules and conjugates.

Which SEC column is right for your application?

Agilent's wide selection of SEC columns gives you the choices you need to perfect separations based on your analytes and method parameters. This chart is an overview of the pore size ranges that yield the best results for common molecule types. We recommend that you begin your method development with Agilent Bio SEC-3 and Bio SEC-5 columns.

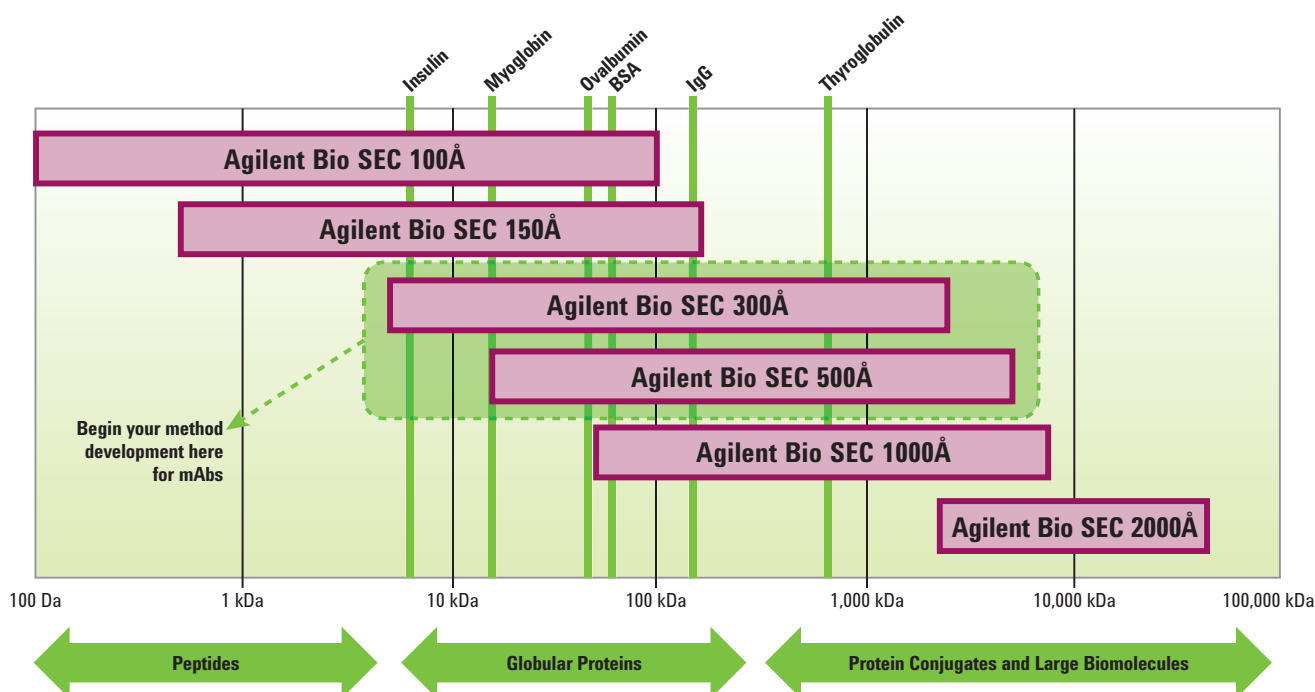

Agilent Bio SEC-3 HPLC columns for faster peptide and protein separations





Size (mm)	Particle Size (µm)	Bio SEC-3 100Å USP L33	Bio SEC-3 150Å USP L33	Bio SEC-3 300Å USP L33
21.2 x 300	3	5190-6850	5190-6851	5190-6852
Prep guards				
21.2 x 50	3	5190-6854	5190-6855	5190-6856

Agilent Bio SEC-5 HPLC columns for size-based biomolecules

Size (mm)	Particle Size (µm)	Bio SEC-5 100Å USP L33	Bio SEC-5 150Å USP L33	Bio SEC-5 300Å USP L33	Bio SEC-5 500Å USP L33	Bio SEC-5 1000Å USP L33	Bio SEC-5 2000Å USP L33
21.2 x 300	5	5190-6863	5190-6864	5190-6865	5190-6866	5190-6867	5190-6868
Prep guards							
21.2 x 50	5	5190-6869	5190-6870	5190-6871	5190-6872	5190-6873	5190-6874













CARTRIDGE COLUMN SYSTEMS

Cartridge Selection Guide

Icon*	Type of Cartridge	Features	Benefits
	ZORBAX Guard Cartridge: Standalone system	High efficiency, standalone, low-dead-volume cartridge Polymeric cartridge designed for leak-tight seals against metal surfaces Reusable fittings	Seals up to 400 bar No gaskets required More solvent-resistant than PEEK Adapt for connections to 1/16 in LC fittings
	ZORBAX Semi-Preparative Guard HPLC Hardware Kit: Standalone system	Easy, low-dead-volume assembly Tubing (polyphenylene sulfone) designed for leak-tight seals against metal surfaces Reusable fittings	Seals up to 2,000 psi (135 bar, 13.5 MPa) No gaskets required Adapt for connections to 1/16 in LC fittings
	ZORBAX and Agilent Prep Preparative Cartridge Column and Guard HPLC System: Standalone and integral hardware options	Easy, low-dead-volume assembly Reusable fittings Hardware options for integral and external guards	Extends column lifetime Permits rapid column changes Can use with 21.2 and 30 mm id columns
	Polymeric Analytical Column and Guard Cartridge	High efficiency Low dead volume Reusable holder	Inexpensive Rapid cartridge changes Extends column lifetime

*Look for these icons to help you select the proper guard cartridges and columns.

Cartridge/Guard Cartridge Systems Compatibility Guide*

Icon	Column Type	Guard Cartridge Holder	ID (mm)	Phases
	Standard fitting	Column guard cartridge (standalone) cartridge holder 820999-901	2.1 3.0 4.6	ZORBAX
				
	Semi-preparative column	Semi-prep guard cartridge (standalone) cartridge holder 840140-901	9.4	ZORBAX
				
	PrepHT	Guard cartridge 820444-901	21.2	ZORBAX Agilent Prep
				
	Analytical	Guard cartridge holder (PL1310-0016) and PLRP-S guard cartridges, 2/pk (PL1612-1801)	3.0	PLRP-S
				
		Guard cartridge holder (PL1310-0016) and PL-SAX guard cartridges, 2/pk (PL1651-0102)	3.0	PL-SAX
				
		Guard cartridge holder (PL1310-0016) and PL-SCX guard cartridges, 2/pk (PL1645-0102)	3.0	PL-SCX
				

*Standalone guard cartridges fit all cartridge and standard fitting columns available from Agilent. All columns without icons are standard fitting columns.

USP DESIGNATIONS – BIOHPLC COLUMNS ONLY

For a full listing of USP designations for all HPLC columns, please consult the Agilent catalog or www.agilent.com

The US Pharmacopeia (USP) is a standard source for many pharmaceutical methods that specifies columns by packing materials rather than by manufacturer. Listed below are the recommended Agilent Technologies columns suitable for most LC methods listed with the USP.

USP Method	USP Packing Materials	Column	Particle Size (µm)
L1	Octadecyl silane chemically bonded to porous silica or ceramic micro-particles, 1.5 to 10 µm in diameter	Poroshell 120 EC-C18	2.7
		Poroshell 120 SB-C18	2.7
		ZORBAX 300SB-C18	1.8, 3.5, 5, 7
		ZORBAX 300 Extend C18	3.5, 5
L7	Octyl silane chemically bonded to totally or superficially porous silica particles, 1.5 to 10 µm in diameter, or a monolithic silica rod	Poroshell 120 EC-C8	2.7
		ZORBAX 300SB-C8	1.8, 3.5, 5, 7
		AdvanceBio RP-mAb SB-C8	3.5
L10	Nitrile groups chemically bonded to porous silica particles, 3 to 10 µm in diameter	ZORBAX 300 SB-CN	3.5, 5, 7
L14	Silica gel 10 µm in diameter with a chemically bonded, strongly basic quaternary ammonium anion-exchange coating	ZORBAX SAX	5
L17	Strong cation-exchange resin consisting of sulfonated cross-linked styrene-divinylbenzene copolymer in the hydrogen form, 7 to 11 µm in diameter	Hi-Plex H	8
		Bio SCX NP10	10
L21	A rigid, spherical styrene-divinylbenzene copolymer, 5 to 10 µm in diameter	PLRP-S 100Å	3, 5, 8, 10
		PLRP-S 300Å	3, 5, 8, 10
		PLRP-S 1000Å	5, 8, 10
		PLRP-S 4000Å	5, 8, 10
L25	Packing having the capacity to separate compounds with a MW range from 1,000 to 5,000 Da (as determined by the polyethylene oxide), applied to neutral, ionic and cationic water-soluble polymers	PL aquagel-OH	5, 8
L26	Butyl silane chemically bonded to totally porous or superficially porous silica particles, 1.5 to 10 µm in diameter	AdvanceBio RP-mAb C4	3.5
L33	Packing having the capacity to separate proteins by molecular size over a range of 4,000 to 400,000 Da. It is spherical, silica-based, and processed to provide pH stability	ZORBAX GF-250	4
		Bio SEC-3	3
		Bio SEC-5	5
		ProSEC 300S	5
L35	A zirconium-stabilized spherical silica packing with a hydrophilic (diol-type) molecular monolayer bonded phase	ZORBAX GF-250	4
		ZORBAX GF-450	6
L50	A strong cation-exchange resin made of porous silica with sulfopropyl groups, 5 to 10 µm in diameter	ZORBAX 300SCX	5
L56	Propyl silane chemically bonded to totally porous silica particles, 3 to 10 µm in diameter	ZORBAX SB-C3	1.5, 3, 5
L68	Spherical, porous silica, 10 µm or less in diameter, the surface of which has been covalently modified with alkyl amide groups and not endcapped for the AdvanceBio Glycan Mapping column	AdvanceBio Glycan Mapping	1.7

BioHPLC Columns Literature

Title	Column/Product	Application	Publication Number	Publication Type
General references				
Better Characterization of Biomolecules using Agilent AdvanceBio Reversed-Phase Columns	Biocolumns	Biomolecules	5991-2032EN	White paper
Agilent Applications for Biopharmaceutical Development and QA/QC	Biocolumns	Biomolecule analysis	5991-1504EN	Application compendium
Agilent SD-1 Purification System	Biocolumns	Prep, semi-prep	5990-9028EN	Brochure
LC Handbook and Compliance Guide to Recombinant Protein Characterization	Reference	Protein analysis	5990-8561EN	Primer
The LC Handbook: Guide to LC Columns and Method Development	Reference	Method development	5990-7595EN	Primer
Compliance for Biopharmaceutical Laboratories	Reference	Proteins	5990-7001EN	Primer
Agilent HPLC Column Selection Guide	Small molecule columns	Many	5990-4435EN	Selection guide
Agilent BioHPLC Column Navigator Poster	Biocolumns	Biomolecules	5990-5526EN	Wall chart
Control pH During Method Development for Better Chromatography	Biocolumns	Method development	5990-9984EN	Technical overview
Agilent BioHPLC Columns for the Characterization of Monoclonal Antibodies	Biocolumns	mAbs	5990-7753EN	Flyer
Infinitely Better for Bio-Molecule Analysis	Agilent 1260 Infinity Bio-inert Quaternary System	Proteins	5990-6220EN	Brochure
Physicochemical Characterization of a Therapeutic Protein by Peptide Mapping, SEC and IEX using the Agilent 1260 Infinity Bio-inert Quaternary LC System	Bio MAb, Bio SEC, ZORBAX Eclipse Plus, Poroshell 120	Protein analysis	5990-6192EN	Application note
Fast Agilent HPLC for Large Biomolecules	PLRP-S, PL-SAX, PL-SCX	Proteins	5990-8663EN	Technical overview

(Continued)



BioHPLC Columns Literature

Title	Column/Product	Application	Publication Number	Publication Type
Affinity – Protein A				
mAb Titer Analysis with the Agilent Bio-Monolith Protein A Column	Bio-Monolith Protein A	mAbs	5991-5135EN	Application note
Cell Culture Optimization Using an Agilent Bio-Monolith Protein A Column and LC/MS	Bio-Monolith Protein A	mAbs	5991-5125EN	Application note
Cell Clone Selection Using the Agilent Bio-Monolith Protein A Column and LC/MS	Bio-Monolith Protein A	mAbs	5991-5124EN	Application note
Reducing Cycle Time for Quantification of Human IgG Using the Agilent Bio-Monolith Protein A HPLC Column	Bio-Monolith Protein A	mAbs	5991-4723EN	Application note
Agilent Bio-Monolith Protein A Monitors Monoclonal Antibody Titer From Cell Cultures	Bio-Monolith Protein A	mAbs	5991-2990EN	Application note
Rapid Human Polyclonal IgG Quantification using the Agilent Bio-Monolith Protein A HPLC Column	Bio-Monolith	IgG	5989-9733EN	Application note
Amino acid analysis				
Separation of Two Sulfurated Amino Acids with other Seventeen Amino Acids by HPLC with Pre-Column Derivatization	Eclipse Plus-C18	Amino acid analysis	5990-5977EN	Application note
Improved Amino Acid Methods using Agilent ZORBAX Eclipse Plus C18 Columns for a Variety of Agilent LC Instrumentation and Separation Goals	ZORBAX Eclipse Plus	Amino acid analysis	5990-4547EN	Application note
Rapid and Precise Determination of Cellular Amino Acid Flux Rates using HPLC with Automated Derivatization with Absorbance Detection	ZORBAX Eclipse Plus	Amino acid analysis	5990-3283EN	Application note
High-Speed Amino Acid Analysis (AAA) on 1.8 μ m Reversed-Phase (RP) Columns	ZORBAX Eclipse Plus	Amino acid analysis	5989-6297EN	Application note
Rapid, Accurate, Sensitive, and Reproducible HPLC Analysis of Amino Acids	ZORBAX Eclipse AAA	Amino acid analysis	5980-1193EN	Application note
HILIC – glycan mapping				
N-Glycan Analysis of mAbs and Other Glycoproteins with UHPLC and Fluorescence Detection	AdvanceBio Glycan Mapping	mAbs	5991-5253EN	Application note
Advance your Glycan Mapping through Higher Speed and Resolution	AdvanceBio Glycan Mapping	Glycan mapping	5991-4730EN	Flyer
Sensitive and Reproducible Glycan Analysis of Human Immunoglobulin G	AdvanceBio Glycan Mapping	Glycan mapping	5991-4801EN	Application note
A Novel HILIC Column for High Speed N-linked Glycan Analysis	AdvanceBio Glycan Mapping	Glycan mapping	5991-4886EN	Application note
Fast and Efficient HILIC Methods for Improved Analysis of Complex Glycan Structures	AdvanceBio Glycan Mapping	Glycosylation	5991-4896EN	Application note
Separation of IgG Glycopeptides using HILIC-LC/MS in Comparison to RP-LC/MS	AdvanceBio Glycan Mapping, AdvanceBio Peptide Mapping	Peptide mapping	5991-4903EN	Application note

(Continued)

BioHPLC Columns Literature

Title	Column/Product	Application	Publication Number	Publication Type
IEX for proteins and mAbs – Bio MAb, Bio IEX, Bio Monolith, PL-SAX, and PL-SCX				
Characterize mAb Charge Variants by Cation-Exchange Chromatography	Bio MAb	mAb analysis	5991-5273EN	Application note
Characterize Fab and Fc Fragments by Cation-Exchange Chromatography	Bio MAb	mAb analysis	5991-5274EN	Application note
Faster Separations Using Agilent Weak Cation-Exchange Columns	Bio WCX	Protein analysis	5990-9931EN	Application note
Optimizing Protein Separations with Agilent Weak Cation-Exchange Columns	Bio WCX	Protein analysis	5990-9628EN	Application note
Analysis of Proteins by Anion-Exchange Chromatography	Bio WAX	Protein analysis	5990-9614EN	Application note
Separation of Protein Standards on Agilent 3 µm Ion-Exchange Columns by Cation-Exchange Chromatography	Bio WCX, Bio SCX, Bio MAb	Protein analysis	5990-9270EN	Application note
Charge Profiling of 2AB-labelled N-linked Glycans	Bio SAX	Charge variants	5991-5221EN	Application note
Top-down and Bottom-up Proteomics with the Agilent 1290 Infinity 2D-LC Solution using DAD and Q-TOF LC/MS	Bio SCX	Proteomics	5991-5179EN	Application note
Ion-Exchange chromatography for Biomolecule Analysis: A "How To" Guide	Bio IEX	Biomolecules	5991-3775EN	User guide
Charge variant analysis of monoclonal antibodies by pH gradient separation on cation-exchange columns	Bio MAb	Charge variants	5990-9940EN	Technical poster
pH Gradient Elution for Improved Separation of Monoclonal Antibody Charge Variants	Bio MAb	Charge variants	5990-9629EN	Application note
Analysis of Intact and C-terminal Digested IgG1 on an Agilent Bio MAb NP5 Column	Bio MAb	mAbs	5991-0895EN	Application note
High-resolution Analysis of Charge Heterogeneity in Monoclonal Antibodies Using pH-gradient Cation-Exchange Chromatography	Bio MAb	Charge variants	5991-1407EN	Application note
Characterize Charged Variants of Proteins with Speed and Confidence	All IEX columns	Charge variants	5991-2449EN	Brochure
Optimizing Protein Separations with Agilent Weak Cation-Exchange Columns	Bio MAb	Protein separation	5991-0565EN	Technical overview
Reducing Cycle Time for Charge Variant Analysis of Monoclonal Antibodies	Bio MAb	Charge variants	5991-4722EN	Application note
Optimization of Protein Separations on Weak Cation-Exchange Columns – a Study of the Particle Size, Buffer Salts, and Gradients	Bio IEX	mAbs	5990-8833EN	Technical poster
Agilent Anion-Exchange Media for Proteins – Loading vs Resolution – Effect of Flow Rate and Example Protein Separations	PL-SAX	Proteins	5990-8777EN	Technical overview
Agilent PL-SCX Cation-Exchange Media for Large Biomolecules	PL-SCX	Proteins	5990-8665EN	Technical overview

(Continued)

BioHPLC Columns Literature

Title	Column/Product	Application	Publication Number	Publication Type
IEX for proteins and mAbs – Bio MAb, Bio IEX, Bio Monolith, PL-SAX, and PL-SCX				
Agilent PL-SAX Anion-Exchange Media for Amyloglucosidase Purification and Analysis	PL-SAX	Protein purification	5990-8664EN	Technical overview
Purity Assessment Following Affinity Separation	PL-SAX	Proteins	5990-8436EN	Technical overview
Rapid Analysis of Adenovirus Type 5 Particles with Bio-Monolith Anion-Exchange HPLC Columns to Support the Development of a High-Titre Manufacturing Platform	Bio-Monolith QA	Adenovirus	5990-5524EN	Application note
Rapid IgM Quantification in Cell Culture Production and Purification Process Monitoring using the Agilent Bio-Monolith QA Column	Bio-Monolith QA	IgM	5989-9674EN	Application note
Agilent Anion-Exchange Media for Proteins	PL-SAX	Protein analysis	5990-8778EN	Technical overview
Fast Monitoring of Bacteriophage Production During Fermentation Using the Agilent Bio-Monolith HPLC Column	Bio-Monolith	Phage production, process monitoring	5990-3247EN	Application note
IEX for oligonucleotides				
High Resolution Separations of Oligonucleotides using PL-SAX Strong Anion-Exchange HPLC Columns	PL-SAX	Oligonucleotides	5990-8297EN	Application note
Agilent PL-SAX 1000Å HPLC Columns and Media	PL-SAX	Analysis/prep - oligonucleotides	5990-8200EN	Flyer
Polar-Modified Stationary Phases are Ideal for the Analysis of Nucleotides	PL-SAX, Pursuit XRs Ultra, Pursuit PFP, Polaris C18-A	Oligonucleotides	5991-2058EN	Application note
Agilent TOP-DNA and TOP-RNA	TOP-RNA	Oligonucleotides	5990-9007EN	Flyer
Agilent PL-SAX Anion-Exchange Media for Nucleotide and Oligonucleotide Analysis	PL-SAX	Oligonucleotides	5990-8779EN	Technical overview
Reversed-Phase – AdvanceBio RP-mAb, Poroshell 300, and ZORBAX 300				
Resolve mAbs Faster and Better	AdvanceBio RP-mAb	mAbs	5991-5160EN	Brochure
Quality-by-Design Approach to Stability Indicating Method Development for Linagliptin Drug Product	ZORBAX RRHD, PLRP-S	Drug development	5991-3834EN	Application note
Application Kits for Standardizing MRM-based Quantitative Plasma Proteomic Workflows on the Agilent 6490 LC/MS System	ZORBAX RRHD	Proteomics	5990-3601EN	Application note
UHPLC optimizations for rapid separation of reduced monoclonal antibodies using ZORBAX RRHD sub-2 µm C3, C8, and diphenyl selectivities	ZORBAX RRHD	mAbs	5991-0009EN	Technical poster
Ultra-fast reversed-phase UHPLC separations for high resolution analysis of intact and reduced monoclonal antibodies using ZORBAX RRHD 300Å, 1.8 µm columns	ZORBAX RRHD	mAbs	5991-0008EN	Technical poster
Characterization of Glycosylation in the Fc Region of Therapeutic Recombinant Monoclonal Antibody	Poroshell 300	mAbs	5991-2323EN	Application note

(Continued)

BioHPLC Columns Literature

Title	Column/Product	Application	Publication Number	Publication Type
Reversed-Phase – AdvanceBio RP-mAb, Poroshell 300, and ZORBAX 300				
Intact Protein Analysis Using an Agilent 6550 Q-TOF Mass Spectrometer	Poroshell 300, ZORBAX RRHD	mAbs	5991-2116EN	Application note
Protein Identification and Impurity Profiling using Reversed-Phase HPLC/UHPLC	All RPLC	Protein analysis	5991-0625EN	Brochure
Agilent MassHunter Easy Access Software for Lot-to-Lot Purification Analysis of a Model Therapeutic Protein	Poroshell 300	Protein purification	5991-3521EN	Application note
Analysis of Monoclonal Antibody (mAb) Using Agilent 1290 Infinity LC System Coupled to Agilent 6530 Accurate-Mass Quadrupole Time-of-Flight (Q-TOF)	Poroshell 300	mAbs	5991-4266EN	Application note
Disulfide Linkage Analysis of IgG1 using an Agilent 1260 Infinity Bio-inert LC System with an Agilent ZORBAX RRHD Diphenyl sub-2 μ m Column	ZORBAX RRHD	mAbs	5991-1694EN	Application note
Reversed-Phase Separation of Intact Monoclonal Antibodies (MAb) using Agilent ZORBAX RRHD 300SB-C8	ZORBAX RRHD 300SB-C8	mAbs	5990-9016EN	Application note
Analysis of Protein Primary Structure when using Wide-Pore sub-2- μ m Particles and UHPLC	ZORBAX RRHD 300SB-C18	Purification/prep	5990-8830EN	Technical poster
Trypsin-Digested Monoclonal Antibody and BSA using Agilent ZORBAX RRHD 300SB-C18	ZORBAX RRHD 300SB-C18	Peptide mapping	5990-8244EN	Application note
Increase your Productivity with Agilent ZORBAX RRHD 300Å 1.8 μ m Columns	ZORBAX RRHD 300SB-C18, C8	Proteins, peptides	5990-8124EN	Flyer
Agilent ZORBAX 300SB-C18 1.8 μ m Rapid Resolution High Definition Columns for Proteins	ZORBAX 300SB-C18	Protein analysis	5990-7989EN	Technical overview
Analysis of Oxidized Insulin Chains using Reversed-Phase Agilent ZORBAX RRHD 300SB-C18	ZORBAX RRHD 300SB-C18	Protein analysis	5990-7988EN	Application note
Rapid Peptide Mapping Method with High Resolution using a sub 2- μ m Column	ZORBAX 300SB-C18	Peptide mapping	5990-4712EN	Application note
Fast Protein Separations Using Agilent Poroshell 300	Poroshell 300	Protein separation	5989-9899EN	Application note
Comparison of ZORBAX StableBond 300Å LC Columns to Optimize Selectivity for Antibody Separations Using HPLC and LC/MS	ZORBAX 300SB	mAbs	5989-6840EN	Application note
Using the High-pH Stability of ZORBAX Poroshell 300Extend-C18 to Increase Signal-to-Noise in LC/MS	Poroshell 300Extend-C18	Optimizing instrument performance	5989-0683EN	Application note
High Speed and Ultra-High Speed Peptide Mapping of Human Monoclonal IgG on Poroshell 300SB-C18, C8, and C3	Poroshell 300	mAbs	5989-0590EN	Application note
Use of Temperature to Increase Resolution in the Ultrafast HPLC Separation of Proteins with ZORBAX Poroshell 300SB-C8 HPLC Columns	Poroshell 300-C8	Protein separation	5989-0589EN	Application note

(Continued)

BioHPLC Columns Literature

Title	Column/Product	Application	Publication Number	Publication Type
Reversed-Phase – AdvanceBio RP-mAb, Poroshell 300, and ZORBAX 300				
Choosing a ZORBAX Poroshell Phase (C3, C8, or C18) for Fast Separation of Monoclonal Antibodies	Poroshell 300	mAbs	5989-0071EN	Application note
Rapid HPLC Analysis of Monoclonal Antibody IgG1 Heavy Chains using ZORBAX Poroshell 300SB-C8	Poroshell 300	mAbs	5989-0070EN	Application note
Fast Separation of Large and Heterogeneous Proteins using ZORBAX Poroshell C18, C8, and C3 Phases	Poroshell 300	Protein separation	5989-0015EN	Application note
Optimization of the Agilent 1100 HPLC System for Superior Results with ZORBAX Poroshell Columns	Poroshell 300	Protein analysis	5988-9998EN	Application note
Using Poroshell 300SB-C18 for High-Sensitivity, High-Throughput Protein Analysis on the Agilent LC/MSD	Poroshell 300-C18	Protein analysis	5988-7031EN	Application note
Decreasing Analysis Time Using Poroshell 300SB-C18 in Analysis of a Protein Digest	Poroshell 300	Peptide mapping	5988-6081EN	Application note
Poroshell 300SB-C18 for Fast, High Protein Separation	Poroshell 300	Proteins	5988-2100ENUS	Brochure
Converting a CHP method for Insulin to Agilent Poroshell 120 Columns	Poroshell 120, Eclipse Plus	Insulin	5990-9029EN	Application note
The Influence of Silica Pore Size and Particle Size on Insulin – A Small Protein Molecule Separation	Poroshell 120, Eclipse Plus, ZORBAX 300SB	Insulin	5990-9028EN	Application note
Reversed-Phase Separation of Intact Monoclonal Antibodies (mAb) using Agilent ZORBAX RRHD 300SB-C8	ZORBAX RRHD 300SB-C8	mAbs	5990-9016EN	Application note
Analysis of Protein Primary Structure when using Wide-Pore sub-2- μ m Particles and UHPLC	ZORBAX RRHD 300SB-C18	Purification/prep	5990-8830EN	Technical poster
Reversed-Phase – PLRP-S for proteins and peptides				
Agilent PLRP-S Media for HPLC Analysis of Peptides	PLRP-S	Peptides	5990-8667EN	Technical overview
Increase Sensitivity with Microbore Polymeric HPLC Columns from Agilent	PLRP-S (microbore)	Peptide hormone, small proteins, small molecules	5990-8666EN	Technical overview
Separation of High MW Fibrous Proteins	PLRP-S	Protein separation	5990-8137EN	Application note
ACN-free HPLC Analysis and Prep Purification of ACP Fragment	PLRP-S	Protein purification	5990-7762EN	Application note
Analysis of Peptides on a PLRP-S 100Å 10 μ m with ELS Detection and Acetonitrile-Free Eluents	PLRP-S	Peptides	5990-7760EN	Application note
Preparative Scale Purification of Dephorelin by Concentration Overload	PLRP-S	Peptide purification	5990-7742EN	Application note
Preparative Scale Purification of Bradykinin by Volume Overload	PLRP-S	Peptide purification	5990-7741EN	Application note
Investigation into the Alternatives to Acetonitrile for the Analysis of Peptides	PLRP-S	Peptides	5990-7740EN	Application note

(Continued)

BioHPLC Columns Literature

Title	Column/Product	Application	Publication Number	Publication Type
Reversed-Phase – PLRP-S for proteins and peptides				
Gradient Purification of Synthetic Acyl Carrier Protein Fragment 65-74	PLRP-S	Proteins	5990-7738EN	Application note
Isocratic Purification of Synthetic Acyl Carrier Protein Fragment 65-74	PLRP-S	Protein purification	5990-7737EN	Application note
Preparative Scale Purification of Bradykinin by Concentration Overload	PLRP-S	Peptide purification	5990-7736EN	Application note
Preparative Scale Purification of Leuprolide by Concentration Overload	PLRP-S	Peptide purification	5990-7735EN	Application note
The Advantages of Polymeric PLRP-S Media	PLRP-S	Peptides	5990-8435EN	Technical overview
Reversed-Phase – oligonucleotides, PLRP-S				
Agilent PLRP-S 50 µm HPLC Media	PLRP-S	Oligonucleotides, peptides, small hormones	5990-8188EN	Flyer
Agilent PLRP-S 100Å HPLC Columns and Media	PLRP-S	Oligonucleotides	5990-8187EN	Flyer
Use Temperature to Enhance Oligonucleotide Mass Transfer and Improve Resolution in Ion-Pair RP HPLC	PLRP-S	Oligonucleotides	5990-7765EN	Application note
Improved Column Lifetime with Thermally Stable Polymer Columns for Oligonucleotide Ion-Pair RP HPLC	PLRP-S	Oligonucleotides	5990-7764EN	Application note
Ion-Pair Reversed-Phase Purification of De-Protected Oligonucleotides – Choice of Pore Size	PLRP-S	Oligonucleotides	5990-7763EN	Application note
HPLC Purification of 26-bp Serial Analysis of Gene Expression Dtags	PLRP-S	Oligonucleotides	5990-7739EN	Application note
High performance DNA oligonucleotide purification using Agilent TOP-DNA	PLRP-S, TOP-DNA	Oligonucleotides	5990-9006EN	Application note
High performance RNA oligonucleotide purification using Agilent TOP-RNA	PLRP-S, TOP-RNA	Oligonucleotides	5990-8974EN	Application note
Reversed-Phase – mRP				
Analysis of Polyethylene Glycol (PEG) and a Mono and Di-PEGylated Therapeutic Protein Using HPLC and Q-TOF Mass Spectrometry	mRP-C18	Biologics	5991-1509EN	Application note
Agilent Protein Fractionation System and Proteomics Reagents	mRP-C18, MARS	Proteomics	5990-8868EN	Data sheet
Macroporous Reversed-Phase C18 High-Recovery Protein Fractionation HPLC Column	mRP-C18	Human serum, biomarkers	5989-2714EN	Brochure

(Continued)

BioHPLC Columns Literature				
Title	Column/Product	Application	Publication Number	Publication Type
Reversed-Phase – peptide mapping				
Keys for Enabling Optimum Peptide Characterizations: A Peptide Mapping “How to” Guide	AdvanceBio Peptide Mapping, MARS, Bio SEC, ZORBAX RRHD, Polaris	Peptide characterization	5991-2348EN	User guide
Reduce peptide mapping time without losing resolution	AdvanceBio Peptide Mapping	Peptide mapping	5991-1696EN	Flyer
High Resolution and Rapid Peptide Mapping of Monoclonal Antibody Using an Agilent 1290 Infinity UHPLC and an Agilent 6550 iFunnel Q-TOF LC/MS System	AdvanceBio Peptide Mapping	mAbs	5991-3600EN	Application note
Fast and Efficient Peptide Mapping of a Monoclonal Antibody (mAb): UHPLC Performance with Superficially Porous Particles	AdvanceBio Peptide Mapping	mAbs	5991-3585EN	Application note
Comparison of Biosimilar and Innovator Monoclonal Antibody Rituximab Using the Agilent 1260 Infinity Bio-inert LC System and Agilent OpenLAB Match Compare Software	AdvanceBio Peptide Mapping, Poroshell 120, Bio SEC	mAbs	5991-4920EN	Application note
Automation for LC/MS Sample Preparation: High Throughput In-Solution Digestion and Peptide Cleanup Enabled by the Agilent AssayMAP Bravo Platform	AdvanceBio Peptide Mapping, AssayMAP Bravo	Protein sample prep	5991-2957EN	Application note
Workflow Automation for LC/MS: In-Solution Protein Digestion, Peptide Cleanup, and Strong Cation-Exchange Fractionation of Peptides Enabled by AssayMAP Technology	AdvanceBio Peptide Mapping, AssayMAP Bravo	Protein sample prep	5991-3602EN	Application note
Automation of Sample Preparation for Accurate and Scalable Quantification and Characterization of Biotherapeutic Proteins Using the Agilent AssayMAP Bravo Platform	AdvanceBio Peptide Mapping, AssayMAP Bravo	Protein sample prep	5991-4872EN	Application note
Size exclusion chromatography – Bio SEC, ProSEC				
Resolve Protein Aggregates and Degradants with Speed and Confidence	SEC columns	Protein analysis	5991-2898EN	Brochure
Size Exclusion Chromatography for Biomolecule Analysis: A “How to” Guide	All SEC	Biomolecule characterization	5991-3651EN	User guide
Molecular Characterization of Biotherapeutics	Bio SEC	mAbs	5991-5220EN	Application note
Determination of Protein Molecular Weight and Size Using the Agilent 1260 Infinity Multi-Detector Bio-SEC Solution with Advanced Light Scattering Detection	Bio SEC	Protein characterization	5991-3955EN	Application note
Detailed Aggregation Characterization of Monoclonal Antibodies Using the Agilent 1260 Infinity Multi-Detector Bio-SEC Solution with Advanced Light Scattering Detection	Bio SEC	mAbs	5991-3954EN	Application note

(Continued)

BioHPLC Columns Literature

Title	Column/Product	Application	Publication Number	Publication Type
Size exclusion chromatography – Bio SEC, ProSEC				
Does Tween 20 affect Monoclonal Antibody Separation?	Bio SEC	mAbs	5991-2793EN	Application note
Choosing the Right Calibration for the Agilent Bio SEC-3 Column	Bio SEC	Biomolecule characterization	5991-2463EN	Application note
Multiple Detector Approaches to Protein Aggregation by SEC	Bio SEC	Protein aggregation	5991-1400EN	Application note
Choosing the Best Filters for Biological Samples Filtration	Bio SEC, ZORBAX RRHD	Biomolecule analysis	5991-1308EN	Application note
Development and partial validation of a SEC method for high-resolution separation and quantification of monoclonal antibodies	Bio SEC	mAbs	5991-0835EN	Application note
Size separation of proteins: what we need to achieve it	Bio SEC	Protein characterization	5990-9944EN	Technical poster
Optimum Pore Size for Characterizing Biomolecules with Agilent Bio SEC Columns	Bio SEC	Biomolecule characterization	5990-9894EN	Application note
Separation of Recombinant Human Erythropoietin (rEPO) Using Agilent Bio SEC-3	Bio SEC	Biotherapeutic separation	5990-9544EN	Application note
N-Terminal Site-Specific PEGylation and Analytical-Scale Purification of PEG Lysozyme	Bio SEC, Poroshell 120	Protein purification	5991-2883EN	Application note
Polyethylene Glycol/Oxide Standards and the Calibration of Agilent ProSEC 300S Columns	ProSEC 300S	Protein analysis	5990-8147EN	Application note
Precise Determination of Protein Molecular Weight using the Agilent 1260 Infinity Multi-Detector GPC/SEC System	Bio SEC	Protein analysis	5991-2884EN	Application note
Defining the Optimum Parameters for Efficient Size Separations of Proteins	Bio SEC	Proteins	5990-8895EN	Application note
Defining the Optimum Parameters for Efficient Size Separations of Proteins	Bio SEC	Proteins	5990-8832EN	Technical poster
Fast Separation of Monoclonal Antibody and Dimer by SEC with Agilent Bio SEC	Bio SEC	mAbs	5990-8613EN	Application note
Polyethylene Glycol/Oxide Standards and the Calibration of Agilent ProSEC 300S Columns	ProSEC 300S	SEC	5990-8147EN	Application note
Analysis of Complex Bacterial Cell Division Proteins by Size Exclusion Chromatography (SEC)	ProSEC 300S	Protein analysis	5990-8143EN	Application note
Analysis of Hsp47, a Collagen Chaperone, by Size Exclusion Chromatography (SEC)	ProSEC 300S	Protein analysis	5990-8142EN	Application note
Progressive Denaturation of Globular Proteins in Urea	ProSEC 300S	Proteins	5990-8141EN	Application note
The Effect of Temperature on Protein Size Exclusion Chromatography	ProSEC 300S	Protein separation	5990-8140EN	Application note

(Continued)

BioHPLC Columns Literature

Title	Column/Product	Application	Publication Number	Publication Type
Size exclusion chromatography – Bio SEC, ProSEC				
The Effect of NaCl Concentration on Protein Size Exclusion Chromatography	ProSEC 300S	Protein separation	5990-8139EN	Application note
Effect of pH on Protein Size Exclusion Chromatography	ProSEC 300S	Protein analysis	5990-8138EN	Application note
Static Light Scattering Analysis of Globular Proteins with Agilent ProSEC 300S Columns	ProSEC 300S	Proteins	5990-7939EN	Application note
Analysis of Albumin Proteins using ProSEC 300S Columns	ProSEC 300S	Protein analysis	5990-7852EN	Application note
Analysis of Globulins using ProSEC 300S Columns	ProSEC 300S	Protein analysis	5990-7851EN	Application note
Analysis of Various Globular Proteins using ProSEC 300S Columns	ProSEC 300S	Protein analysis	5990-7850EN	Application note
Globular Proteins and the Calibration of ProSEC 300S Columns	ProSEC 300S	Protein analysis	5990-7767EN	Application note
Light Scattering Analysis of BSA with ProSEC 300S Columns	ProSEC 300S	Protein analysis	5990-7766EN	Application note
ProSEC 300S Protein Characterization Columns	ProSEC 300S	Proteins	5990-7468EN	Flyer
Characterization of Monoclonal Antibodies on the Agilent 1260 Infinity Bio-inert Quaternary LC by Size Exclusion Chromatography using the Agilent BioSEC Columns	Bio SEC	mAbs	5990-6414EN	Application note
Miscellaneous				
Reduce Tubing Volume to Optimize Column Performance	Small diameter columns	Optimizing instrument performance	5990-4964EN	Application note
Biomolecule Purification – Purification Columns and Media for Peptides, Oligonucleotides, and Proteins	PLRP-S, PL-SAX, PL-SCX	Purification/prep	5990-8335EN	Brochure
High Purity, High Recovery, High Throughput – Agilent Technologies Offers Two New Lines of Preparative HPLC Columns	Agilent Prep HT	Purification/prep	5989-2350EN	Brochure



TIPS & TOOLS

For more on the above, and other guides that will help in your characterization, go to:
www.agilent.com/chem/getbioguides

BIOPHARM DEFINITIONS

A

adaptive immune response

The response of antigen-specific lymphocytes to antigen.

ADC

Antibody-drug conjugates are complex molecules composed of an antibody linked to a biological active anticancer drug.

ADME

Absorption, distribution, metabolism, and excretion (ADME) describes the processes that affect a pharmaceutical compound as it passes through an organism.

affinity

Attraction between particles or substances; relatively speaking, a measure of the attraction of one molecule toward another.

aggregate

A clustered mass, as of protein molecules; or to cluster together in such a way.

albumins

Protein constituents of blood plasma and serum also found in muscle, egg white, and milk.

alkylation

The introduction, by substitution or addition, of an alkyl group into an organic compound; alkylating agents are various substances that contain an alkyl radical and that can, therefore, replace a hydrogen atom in an organic compound; alkylation is used to prevent refolding of already reduced proteins during peptide mapping.

alpha helix (α -helix)

A coil or spiral element of a protein's secondary structure.

amino acids

A class of 20 naturally occurring hydrocarbon molecules that combine to form proteins in living things. They include alanine (A), aspartic acid or asparagine (B), cysteine (C), glutamic acid (Z) or glutamine (Q), phenylalanine (P), glycine (G), histidine (H), isoleucine (I), lysine (K), leucine (L), methionine (M), proline (P), arginine (R), serine (S), threonine (T), valine (V), tryptophan (W), and tyrosine (Y). (Those are the so-called normal amino acids; others have been synthesized and are used in medicinal chemistry). They are incorporated into proteins by transfer RNA according to the genetic code.

amphoteric

A substance that has both acid and base properties. Amphoteric molecules can accept or donate protons to act as an acid or a base.

antibody

Protein molecules produced by the immune system. Antibodies recognize foreign molecules or structures such as bacteria, viruses, and various antigens to which the body has been exposed.

antigen

Any agent that reacts specifically with an antibody. Antigens can contain more than one site capable of binding to a particular antibody. See immunogen.

antigenicity

The capacity of a substance to induce the formation of antibodies or to elicit an immune response when injected into an animal.

antiserum

The fluid component of clotted blood from an immune individual that contains antibodies against the molecule used for immunization.

API

Active pharmaceutical ingredient (API). See drug substance.

B**base**

One of the molecules - adenine (A), guanine (G), cytosine (C), thymine (T), or uracil (U) - which form part of the structure of DNA and RNA molecules. The order of bases in a DNA molecule determines the structure of proteins encoded by that DNA. See nucleotide.

base pair

Two bases on different strands of nucleic acid that join. In DNA, cytosine always pairs with guanine, and adenine always links to thymine. In RNA molecules, adenine joins to uracil.

beta sheet (β -sheet)

A structure resulting from the regular, accordion-like folding of polypeptide chains; the chief alternative to the *alpha* helix.

bioactivity

A protein's ability to function correctly after it has been delivered to the active site of the body (*in vivo*).

bioavailability

A measure of the rate and the total amount of drug that reaches the target tissue after administration.

biobetter

A biopharmaceutical that is significantly different in structure, form, and function from the innovator product.

biogeneric

A biopharmaceutical that is produced and licensed by a different company than the one that originally licensed it. A biogeneric is used for the same indications, and may be produced by a substantially similar process, or one that is different, but results in comparable product. See also biosimilar.

biologics

Products of living organisms used in the prevention or treatment of disease.

biomarker

A physiological event or molecule that can be measured. Examples include the presence or absence of a protein or a mutated gene. Biomarkers are often used to indicate the presence or progression of a disease.

biosciences

A term that encompasses both biotech and pharmaceutical companies.

biosimilar

A biopharmaceutical that is produced using a different cell line or master cell bank or different process, yet meets criteria for comparability in clinical activity. A biosimilar may differ in its purity/impurity profile, and its potency may differ in a definable way. See also biogeneric and follow-on biologic.

BLA

Biologics license application; the required application for marketing a biologic product in the United States. Most biotechnology-derived drugs are approved through a BLA, rather than an NDA, although some biologics, such as recombinant insulin and human growth hormone, considered to be simpler in structure and well-characterized, have been approved under NDAs.

bulk active ingredient

Also bulk drug substance, the active ingredient that is formulated with excipients to produce the drug product formulation. Biopharmaceuticals are produced "in bulk" through bioprocessing.

C**CBER**

Center for Biologics Evaluation and Research at the US FDA. CBER regulates vaccines, gene therapy, cellular products, allergenic extracts, antitoxins, antivenoms, venoms, blood, and blood products (clotting factors and plasma-derived products).

CDER

Center for Drug Evaluation and Research. The largest of FDA's six centers, CDER regulates prescription and over-the-counter drugs, and therapeutic proteins and monoclonal antibodies for use *in vivo*.

cGMP

Current good manufacturing practice, see GMP.

change control

A system by which changes to facilities, equipment, and processes are documented and approved. The change control system ensures that changes are evaluated and approved prior to implementation to maintain the facilities, equipment, and processes in a validated state.

chaotropic

Disrupting the structure of water, macromolecules, or living systems to promote activities that would have been inhibited by these factors. Urea and guanidine hydrochloride are common chaotropic agents used with proteins.

characterization

Precisely deciphering and describing an entity's properties (physical and chemical properties for a molecular entity; genetic and stability properties for a cell line).

chemokine

Signalling molecules that are involved in the activation and migration of immune system cells. Chemokine signalling plays a key role in the inflammatory response.

chimeric antibody

Antibodies whose gene sequence consists of DNA from two different species. Typically, the term refers to antibodies whose DNA is between 10% and 25% mouse origin, with the remaining sequence being human origin.

C-terminal

Carboxyl-terminal; the carboxyl terminus of a protein chain, with a free carboxyl group.

clinical trial

The process of bringing a drug to market. Phase I trials are initial studies to determine the metabolism and pharmacologic actions of drugs in humans, side effects associated with increasing doses, and to gain early evidence of effectiveness. In Phase II, controlled clinical studies evaluate drug effectiveness for patients with the disease and determine the common short-term side effects and risks. Phase III trials are expanded investigations to gather additional information to evaluate the overall benefit-risk relationship of the drug and provide an adequate basis for physician labeling.

codon

A set of three nucleotide bases in a DNA or RNA sequence, which together code for a unique amino acid. For example, AUG (adenine, uracil, and guanine) codes for the amino acid methionine.

D**deamidation**

Removal of one or more amide groups from the Gln or Asn residue in a protein, converting the residues to Glu, Asp, or isoAsp. Depending on the protein, this may have no effect, or major effects on potency, stability, or solubility.

denaturation

A condition in which a protein unfolds or its polypeptide chains are disordered, rendering the molecules less soluble and usually nonfunctional.

denature

To unfold a protein or break it up, changing its usual three-dimensional structure. Proteins can be denatured by chemical action, heat, or even agitation of a protein solution.

denatured protein

A protein having unfolded or disordered polypeptide chains, which render the molecule less soluble and usually nonfunctional. Sometimes a denatured protein can be refolded (renatured).

dimer

A polymer made up of two identical molecules. When three molecules link up, the resultant polymer is called a trimer. Larger polymers are usually referred to by placing a number before the "-mer" suffix: 4-mer, 5-mer, 6-mer, and so on.

disulfide bond

A covalent bond formed between sulfur atoms of different cysteines in a protein; such bonds (links, bridges) help hold proteins together.

DNA

Deoxyribonucleic acid, the nucleic acid based on deoxyribose (a sugar) and the nucleotides G, A, T, and C. Double-stranded DNA has a corkscrew-ladder shape (the double helix) and is the primary component of chromosomes, which thus carry inheritable characteristics of life. See nucleotides and nucleic acids.

downstream processing

The phase of a biomanufacturing campaign that consists of harvesting, purifying, and formulating the product.

drug candidate

A small molecule or biologic that is being tested for its therapeutic potential.

drug development

The process of testing therapeutic molecules for safety and efficacy in animals and humans, and developing appropriate formulation, delivery, and manufacturing methods.

drug discovery

The process of identifying molecules with a therapeutic effect against a target disease.

drug substance

Also known as active pharmaceutical ingredient (API); the active drug chemical or biological substance in purified bulk form. The drug substance is further processed to derive a drug product.

E

E. coli

Escherichia coli is a common gut bacterium that has been studied intensively by geneticists because of its small genome size, normal lack of pathogenicity, and ease of growth in the laboratory.

efficacy

The ability of a substance (such as a protein therapeutic) to produce a desired clinical effect; its strength and effectiveness; usefulness; the power to produce an effect.

enzymes

Proteins that catalyze biochemical reactions by causing or speeding up reactions without being changed in the process themselves.

epitope

A molecular region on the surface of an antigen that elicits an immune response and can combine with the specific antibody produced by such a response; also called a determinant or an antigenic determinant.

excipient

A type of raw material that is present in the drug product and, thus, has direct patient contact; includes inert materials such as bulking agents, stabilizing agents, preservatives, salts, solvents, or water. An excipient must be evaluated for safety in animals, unless it has been approved as GRAS, or is on a list of approved excipients.

express

To translate a cell's genetic information, stored in its DNA (gene), into a specific protein.

expression system

A host organism combined with a genetic vector (such as a virus or circular DNA molecule called a plasmid) that is loaded with a gene of interest. The expression system provides the genetic context in which a gene will function in the cell, that is, the gene will be expressed as a protein.

expression vector

A virus, plasmid, cosmid, or artificial chromosome that delivers foreign genes to a host, creating a recombinant organism that will express the desired protein.

F

Fab

Antigen-binding fragment of an immunoglobulin. An IgG Fab is prepared by enzymatic cleavage of the intact tetrameric IgG, and reduction of the interchain disulfide links, and binds one mole of antigen per mole. See F(ab)'₂.

F(ab)'₂

Dimeric antigen-binding fragment of an immunoglobulin. An IgG F(ab)'₂ is prepared by enzymatic digestion of an intact IgG, which removes the Fc portion of the molecule. F(ab)'₂ binds two moles of antigen per mole. See Fab.

FAb

Fragment antigen binding site. Antibodies are Y-shaped molecules. The arms of each Y are the FAb regions that bind to antigens; the stem of the Y is the Fc region, which attracts microbe-engulfing cells to destroy what has been bound. If the active part of an antibody can be identified, sometimes only that part of it may be needed as a therapeutic molecule (facilitating production and processing by reducing the size and lessening the chances of an immune response in patients who receive the drug). This fragment may be conjugated to another molecule (such as PEG) for stability or other reasons.

Fc

Portion of an immunoglobulin molecule that carries various effector functions, such as the ability to bind complement. Important in immunological activities, and separable from the antigen-binding portion by enzymatic or chemical cleavage. See Fab.

FDA

US Food and Drug Administration.

folding

A process in which a protein spontaneously forms into its correct, knotted tertiary structure that is held in place by chemical bonds and by attractive forces between atoms.

follow-on biologic

Another term for biosimilar or biogenetic.

formulation

The process by which different chemical substances, including the active drug, are combined to produce a final medicinal product.

G**gene**

The unit of inheritance consisting of a sequence of DNA occupying a specific position within the genome. Three types of genes have been identified: structural genes encoding particular proteins; regulatory genes controlling the expression of the other genes; and genes for transfer RNA or ribosomal RNA instead of proteins.

gene therapy

Treats, cures, or prevents disease by changing the expression of a person's genes or inserting genes into the genome. Current gene therapy is primarily experimental, with most human clinical trials only in the research stages. Gene therapy can target somatic (body) or germ (egg and sperm) cells. In somatic gene therapy, the recipient's genome is changed, but the change is not passed along to the next generation. In germ-like gene therapy, the parent's egg and sperm cells are changed with the goal of passing on the changes to their offspring.

genetic engineering

Altering the genetic material of cells or organisms to make them capable or producing new substances or performing new functions.

genome

All of the genetic material in the chromosomes of a particular organism.

genomics

The application of recombinant DNA, DNA sequencing methods, and bioinformatics to sequence, assemble, and analyze the function and structure of the genome.

GLP

Good laboratory practice. According to 21 CFR Part 58, regulations to ensure quality of nonclinical laboratory studies related to safety. All activity is recorded, trained staff use only established procedures, and records and samples are maintained.

glycoproteins

Proteins that contain carbohydrate, sugar, side chains added as a post-translational process; presence of sugar side chains often affects activity and *in vivo* stability.

glycosylation

Adding one or more carbohydrate molecules onto a protein (a glycoprotein) after it has been built by the ribosome; a post-translational modification.

GMO

A genetically modified organism (GMO) is one in which the DNA has been altered using genetic engineering techniques.

GMP

Good manufacturing practice. According to 21 CFR Parts 210, 211, 600, 610, and (for devices) 820, current good manufacturing practices (cGMPs) influence the manner in which biopharmaceuticals and other drugs and medical devices are produced. Standard operating procedures must be followed, processes must be validated, equipment must be qualified, and properly trained staff must maintain a clean/sterile environment.

Golgi body

A cell organelle consisting of stacked membranes where post-translational modifications of proteins are performed; also called Golgi apparatus.

GRAS

Generally recognized as safe is a US FDA designation that a chemical or substance added to food is considered safe by experts, and so is exempt from the usual Federal Food, Drug, and Cosmetic Act (FFDCA) food additive tolerance requirements.

H**high throughput screening**

HTS is an automated trial-and-error testing, typically using robotics, of very large sets of chemicals or materials.

hybridization

The process of joining complementary strands of DNA to make an RNA-DNA hybrid. The partial pairing of DNA single strands from genetically different sources.

hydrophilic

Having an affinity for water; attracting, dissolving in, or absorbing water; readily absorbing moisture; having strongly polar molecular groups that readily interact with water.

hydrophobic

Insoluble in water; the extent of insolubility; not readily absorbing water; resisting or repelling water, wetting, or hydration; or being adversely affected by water.

I-J**immunogen**

A substance that provokes an immune response, that is, the body recognizes it as a foreign agent that must be expelled or destroyed.

in vitro

Performed using laboratory apparatus rather than a living animal

in vivo

Involving living animals or humans as test subjects.

intermediates

Substances formed in the middle stages of a series of processing steps; stepping stones between a parent substance and a final product.

investigational new drug

INDs are drugs that have gained FDA approval to be shipped across state lines, typically for clinical trials, but has not yet gained approval for marketing.

K-L**large molecule drug**

Another name for protein therapeutics. Large molecule drugs are too large to enter cells.

ligase

An enzyme that causes molecular fragments (such as DNA, RNA, or peptides) to link together; DNA ligase is used with restriction enzymes to create recombinant DNA.

light-scattering analysis

Analytical method that gives information about the size and shape of molecules based on how they disperse ultraviolet and visible light.

M**mAb**

Monoconal antibody; a highly specific, purified antibody that recognizes only a single epitope.

metabolome

This is the full complement of small-molecule metabolites (such as metabolomic intermediates, hormones and other signalling molecules, and secondary metabolites) that are found within a biological sample or organism.

metabolomics

The study of the metabolome.

microheterogeneity

In biopharma, usually small differences in the amino acid sequence or structure of a polypeptide chain. For example, to produce a recombinant protein in *E. coli*, a methionine (Met) must be added to one end of the protein sequence to act as a signal that initiates protein synthesis. In most cases, Met is removed once the protein is made. Sometimes the Met is removed for only some of the molecules. The purified product is then a mixture of a protein with the native sequence and a protein with the native sequence plus the extra amino acid.

mRNA

Messenger RNA; which serves as a template for protein synthesis. It is made as a complement to a DNA sequence and then transported from the cell nucleus to the ribosomes.

multimer

Any small polymer; in biopharma, usually a protein made up of more than one polypeptide chain.

N**native**

The natural nondenatured state exhibiting biological activity; in biopharma, it usually refers to a molecule's normal three-dimensional structure under optimal conditions.

NBE

New biological entities are proteins, peptides, antibodies, viruses, and vaccines that prevent or treat disease. NBEs are significant because they can be active against all extracellular targets.

NDA

New drug application; CDER's equivalent of the BLA. It is used for small-molecules and some biopharmaceuticals (such as hormones and small peptides), which are regulated by CDER rather than CBER.

N-terminal

Amino-terminal or amine terminus; the amine terminus of a protein chain (with a free α -amino group).

nucleic acids

DNA or RNA: chain-like molecules composed of nucleotides.

nucleotides

Molecules composed of nitrogen-rich base, phosphoric acid, and a sugar. The bases can be adenine (A), cytosine (C), guanine (G), thymine (T), or uracil (U).

O**oxidation**

Chemical reaction in which a compound or atom loses valence electrons, due to reaction with an oxidising agent (for example oxygen, peroxides, metal ions, or others). Many proteins are prone to oxidation on exposure to air (such as oxidation of the methionine (Met) amino acid into methionine sulfide or sulfone). See also redox.

P**PAT**

Process analytical technology; an FDA initiative that seeks to encourage industry to develop and use new analytical technology and multivariate analyses as part of risk management during process development, manufacturing, and quality control testing. PAT includes on-line, real-time analyses, process control tools, continuous improvement and knowledge management tools, and statistical tools.

PEGylation

Covalent attachment of polyethylene glycol molecule(s) to a protein molecule through selected amino acid side groups, for example free amino or sulfhydryl groups. May be done to decrease toxicity or improve its solubility and circulating half-life in the body.

peptide bond

The carbon-nitrogen covalent bond (link) between an amino group of one amino acid and a carboxyl group of another, formed by removing water and resulting in the group RCO-NH. This linkage does not allow free rotation, and it is the important bond that connects amino acid monomers to form the polymer known as a polypeptide.

peptide mapping

Bioanalytical method in which proteins are selectively cleaved by enzymes to create a characteristic pattern of peptides that is elucidated through chromatographic separations and spectroscopic or spectrometric detection.

peptides

Proteins consisting of fewer than 40 amino acids.

pharmacodynamics

PD is the study of the effect of a drug on the body; in particular, the effect of the drug as it relates to increasing dose.

pharmacogenomics

The science of understanding the correlation between an individual patient's genetic make-up (genotype) and their response to drug treatment. Some drugs work well in some patient populations, and not as well in others.

pharmacokinetics

PK is the study of drug absorption, and drug distribution within the body, drug metabolism, and drug excretion.

phosphorylation

Addition of a phosphate (PO_4) group to a molecule, usually enzymatically done by transferring a phosphate group from ATP (adenosine triphosphate).

pI

Isoelectric point, the pH at which a substance has no net charge; above which a substance acts as a base and below which it acts as an acid. A solution of proteins or amino acids has its minimum conductivity and viscosity at the isoelectric point. The pI is a pH value for a given substance; for example, the pI of gelatin is pH 4.7. pI can be used to identify and characterize proteins.

plasmid

Hereditary material that is not part of a chromosome. Plasmids are circular and self-replicating and found (naturally in bacteria and some yeasts) in the cytoplasm of cells. They can be used as vectors for introducing up to 10,000 base pairs of foreign DNA into recipient cells.

polishing

The final purification step(s) in a biopharmaceutical manufacturing process, usually involving an affinity or other refined chromatography method. Often, this step is the most expensive technique in the process because it handles the smallest amount of material.

polyclonal antibody

A mixture of antibodies that recognize different epitopes on the same antigen; each antibody is produced by a different B-cell.

post-translational modification

After a DNA sequence has been interpreted, and a protein has been created, it may be modified by the addition of sugar (glycosylation) or other molecules. This protein processing is done by the Golgi bodies after proteins have been constructed by ribosomes.

preclinical studies

The testing of experimental drugs in the test tube or in animals. The testing that occurs before trials in humans may be done.

protease

An enzyme that cleaves the peptide bonds linking amino acids in protein molecules, classified according to the most prominent functional molecular group (such as serine or cysteine) at the active site; also called proteinase.

protein variants

Proteins with the same amino acid sequences but different folds or different carbohydrate residues. They must be separated from the therapeutic proteins.

proteins

Complex organic macromolecules whose structures are coded in an organism's DNA. Each is a chain of more than 40 amino acids in peptide linkages that folds back upon itself in a particular way. Proteins are the principal constituent of all cell protoplasm (the entire contents of a live cell). Each protein has a unique, genetically defined amino acid sequence that determines its specific shape and function (as enzymes, structural elements, hormones, and immunoglobulins, involved in oxygen transport, muscle contraction, or electron transport, for instance).

protein therapeutics

See large molecule drugs.

proteolysis

Separation (cleavage) of peptide bonds in proteins by proteases (enzymes that recognize and cut specific peptide bonds) or other means.

proteome

The entire set of proteins in an organism.

proteomics

The large-scale study of the structure and function of proteins.

Q-R

quality assurance

QA comprises the quality systems and processes used to control every step of pharmaceutical manufacturing to ensure that the product meets all of its specifications and quality attributes, and that all steps were done and documented in compliance with cGMP.

quality control

QC is the system of testing that confirms and measures the quality of raw materials, process intermediates, final product, and environmental samples.

recombinant

Refers to DNA (or the protein resulting from such DNA) that has been genetically engineered to contain genetic material from another organism. Genetically altered microorganisms are usually referred to as recombinant, whereas plants and animals so modified are called transgenic. See transgenics.

redox

Equilibrium reaction of oxidation/reduction, for example, thiol-disulfide exchange, a step used during refolding of recombinant proteins that contain cysteine (Cys) residues, to form correct pairing of sulfhydryl groups (-SH) and form stable disulfide (S-S) bonds.

RNA

Ribonucleic acid, the nucleic acid based on ribose (a sugar) and the nucleotides G, A, U, and C. It translates the information encoded by DNA into amino acid sequences the cell uses to make proteins. Similar to DNA but based on ribose, and with the base uracil (U) in place of thymine (T). Various forms of RNA are found; mRNA (messenger RNA), tRNA (transfer RNA), and rRNA (ribosomal RNA). Most RNA molecules are single-stranded, although they can form double-stranded units.

S

secondary structure

In proteins, the folding, twisting, coiled, sometimes spring-like chain that results when hydrogen bonds form between the adjacent parts of a molecule, as in *alpha* helix or *beta* sheet.

small molecule drug

A drug that is chemically synthesized in the laboratory. Small molecule drugs are small enough to enter cells.

SOPs

Standard operating procedures; detailed (step-by-step) instructions to achieve uniformity in the performance of a specific process or piece of equipment, which are approved by the quality control unit and used for GMP operations.

T-U

tertiary structure

The three-dimensional folding (its normal state) of a polypeptide chain in a protein molecule.

transgenics

The alteration of plant or animal DNA so that it contains a gene from another organism. There are two types of cells in animals and plants, germ-line cells (the sperm and egg in animals, pollen and ovule in plants) and somatic cells (all other cells). Germ-line DNA is altered in transgenic animals and plants so those alterations are passed on to offspring. That is done to produce therapeutics, to study disease, and to improve livestock strains. Transgenic plants have been created for increased resistance to disease and insects as well as to make biopharmaceuticals.

translation

The process by which information transferred from DNA by RNA specifies the sequence of amino acids in a polypeptide (protein) chain.

tRNA

Transfer RNA, a type of RNA with triplet nucleotide sequences that complement the nucleotide coding sequences of mRNA. In protein synthesis, tRNA bonds with amino acids and transfers them to the ribosomes, where proteins are assembled according to the genetic code carried by mRNA.

unfolding

A form of protein degradation in which the three-dimensional structure of a molecule unravels to something that more closely resembles a basic chain of amino acids.

upstream processing

The phase of biomanufacturing that consists of establishing cell banks and seeding and scaling up cell cultures.

V-Z**vaccines**

Preparations that elicit an immune response (production of antibodies) to protect a person or animal from a disease-causing agent.

virus

The simplest form of life: RNA or DNA wrapped in a shell of protein, sometimes with a means of injecting that genetic material into a host organism (infection). Viruses cannot reproduce on their own, but require the aid of a host (bacteria, plant, or animal). The host cell's synthesis is often inhibited by the infecting virus, which may or may not result in disease (more than 200 viruses are known to produce human disease). An individual virus particle is called a virion, and virions vary in structure, complexity, and size (ranging from 20-25 nm or less to 2,000 nm or more). Six classes of virus are defined by whether they are single or double stranded, DNA or RNA, positive or negative.

well-characterized

A chemical entity whose identity, purity, impurities, potency, and quantity can be determined and controlled; most well-characterized biologics are recombinant DNA-derived proteins or monoclonal antibodies.

References

Guide to BioTerminology 2nd edition, *BioPharm International*, August 2006.

The Biotech Primer, *Biotech Primer, Inc.*, June 2012.

CITATIONS

AdvanceBio Peptide Mapping Citations

Amano, M. *et al.* (2014) Detection of Histidine Oxidation in a Monoclonal Immunoglobulin Gamma (IgG) 1 Antibody. *Analytical Chemistry*, 86(15): 7536-7543
doi:10.1021/ac501300m

Luna, LG & Coody, K. (2014) Identification of *X. laevis* Vitellogenin Peptide Biomarkers for Quantification by Liquid Chromatography Tandem Mass Spectrometry. *J Anal Bioanal Tech*, 5:3
doi:10.4172/2155-9872.1000194

Bio SEC Citations

Campanella, B. *et al.* (2014) Impact of Protein Concentration on the Determination of Thiolic Groups of Ovalbumin: A Size Exclusion Chromatography–Chemical Vapor Generation–Atomic Fluorescence Spectrometry Study via Mercury Labeling. *Analytical Chemistry*, 86(4): 2251-2256
doi:10.1021/ac4041795

Campanella, B. *et al.* (2014) Direct, simple derivatization of disulfide bonds in proteins with organic mercury in alkaline medium without any chemical pre-reducing agents. *Analytica Chimica Acta*, Volume 843: 1-6
doi:10.1016/j.aca.2014.07.003

Goldspiel, JT. *et al.* (2013) Stability of alemtuzumab solutions at room temperature. *Am J Health Syst Pharm*, 70(5): 439–442
doi:10.2146/ajhp110632

Baid, R. *et al.* (2013) Biosynthesis, Characterization, and Efficacy in Retinal Degenerative Diseases of Lens Epithelium-derived Growth Factor Fragment (LEDGF₁₋₃₂₆), a Novel Therapeutic Protein. June 14, 2013. *The Journal of Biological Chemistry*, 288(24): 17372-83
doi:10.1074/jbc.M112.441618

(Continued)

Bio SEC Citations

Coffey, A. (2012) Enhancing Aggregation Analysis by Size Exclusion Chromatography (SEC)—Inclusion of Light Scattering Detection. *LCGC The Applications Notebook*
<http://www.spectroscopyonline.com/spectroscopy/article/articleDetail.jsp?id=798753>

Gammelgaard, B. *et al.* (2012) Estimating Intestinal Absorption of Inorganic and Organic Selenium Compounds by in Vitro Flux and Biotransformation Studies in Caco-2 Cells and ICP-MS Detection. *J Biological Trace Element Research*, 145(2): 248-256
doi:10.1007/s12011-011-9174-y 2012-02-01

Karasiński, J. *et al.* (2014) Analytical protocol for investigation of zinc speciation in plant tissue. *J Chemical Papers*, 68(3): 291-299
doi:10.2478/s11696-013-0460-3

BioMonolith Citations

St. Amand, MM., Ogunnaike, BA., Robinson, AS. (2014) Development of at-line assay to monitor charge variants of MAbs during production. *Biotechnol Progress*, 30(1): 249-255
doi:10.1002/btpr.1848

Podgornik, A., Krajnc, NL. (2012) Application of monoliths for bioparticle isolation. *J. Sep. Science*, 35 (22): 3059-3072
doi:10.1002/jssc.201200387

Mathis, JM. *et al.* (2011) Genetic Incorporation of Human Metallothionein into the Adenovirus Protein IX for Non-Invasive SPECT Imaging. *PLoS ONE*, 6(2): e16792
doi:10.1371/journal.pone.0016792

(Continued)

BioMonolith Citations

Haslene-Hox, H. *et al.* (2011) A New Method for Isolation of Interstitial Fluid from Human Solid Tumors Applied to Proteomic Analysis of Ovarian Carcinoma Tissue. *PLoS ONE*, 6(4): e19217
doi:10.1371/journal.pone.0019217

Whitfield, R.J. *et al.* (2009) Rapid high-performance liquid chromatographic analysis of adenovirus type 5 particles with a prototype anion-exchange analytical monolith column. *Journal of Chromatography A*, 1216(13): 2725-2729
doi:10.1016/j.chroma.2008.11.010

PLRP-S Citations

Jackson D. *et al.* (2014) *In Vitro* and *In Vivo* Evaluation of Cysteine and Site Specific Conjugated Herceptin Antibody-Drug Conjugates. *PLOS one*, 9(1)
doi:10.1371/journal.pone.0083865

Linke, T. *et al.* (2014) Development and scale-up of a commercial fed batch refolding process for an anti-CD22 two chain immunotoxin. *Biotechnol Progress*
doi:10.1002/btpr.1983

Li, Y., *et al.* (2014) Characterization of the Degradation Products of a Color-Changed Monoclonal Antibody: Tryptophan-Derived Chromophores. *Analytical Chemistry*, 86(14): 6850-6857
doi:10.1021/ac404218t

Campos Motta, TM. *et al.* (2014) Detection and confirmation of milk adulteration with cheese whey using proteomics-like sample preparation and liquid chromatography-electrospray-tandem mass spectrometry analysis. *Talanta*, 120: 498-505
doi:10.1016/j.talanta.2013.11.093

Ochiai, T. *et al.* (2014) Mechanism underlying the transient increase of serum iron during FOLFOX/FOLFIRI therapy. *Molecular and Clinical Oncology*, 2(6): 968-972
doi:10.3892/mco.2014.385

PLRP-S Citations

Bender, B. *et al.* (2014) A Mechanistic Pharmacokinetic Model Elucidating the Disposition of Trastuzumab Emtansine (T-DM1), an Antibody-Drug Conjugate (ADC) for Treatment of Metastatic Breast Cancer. *The AAPS Journal*, 16(5): 994-1008
doi:10.1208/s12248-014-9618-3

Fekete, S. *et al.* (2013) Analytical strategies for the characterization of therapeutic monoclonal antibodies. *TrAC Trends in Analytical Chemistry*, Volume 42: 74-83
doi:10.1016/j.trac.2012.09.012

Gong, J. *et al.* (2014) Quantitative Analysis of Polyethylene Glycol (PEG) and PEGylated Proteins in Animal Tissues by LC-MS/MS Coupled with In-Source CID. *Analytical Chemistry*, 86(15): 7642-7649
doi:10.1021/ac501507g

Cattaneo, S. *et al.* (2014) Targeted peptides for the quantitative evaluation of casein plasminolysis in drinking milk. *Food Chemistry*, Volume 155: 179-185
doi:10.1016/j.foodchem.2014.01.053

Boswell, CE. *et al.* (2013) An integrated approach to identify normal tissue expression of targets for antibody-drug conjugates: case study of TENB2. *British Journal of Pharmacology*, 168(2): 445-447
doi:10.1111/j.1476-5381.2012.02138.x

Holder, A. *et al.* (2014) Quantification of bio- and techno-functional peptides in tryptic bovine micellar casein and β -casein hydrolysates. *Food Chemistry*, Volume 158: 118-124
doi:10.1016/j.foodchem.2014.02.104

Nakagawa, M., Tojo, H. & Fujii, S. (2011) A Glycan of Ψ -Factor from *Dictyostelium discoideum* Contains a Bisecting-GlcNAc, an Intersecting-GlcNAc, and a Core α -1,6-Fucose. *Bioscience, Biotechnology, and Biochemistry*, 75(10):1964-1970
doi:10.1271/bbb.110369

(Continued)

PLRP-S Citations

Della Donna, L. *et al.* (2011) Mass spectrometric measurements of the apolipoproteins of bovine (*Bos taurus*) HDL. *Comparative Biochemistry and Physiology Part D: Genomics and Proteomics*, 7(1): 9-13
doi:10.1016/j.cbd.2011.10.001

Vondenhoff, GHM. *et al.* (2011) Characterization of Peptide Chain Length and Constituency Requirements for YejABEF-Mediated Uptake of Microcin C Analogues. *The Journal of Bacteriology*, 193(14): 3618-3623
doi:10.1128/JB.00172-11

Šotkovský, P. *et al.* (2011) A new approach to the isolation and characterization of wheat flour allergens. *Clinical & Experimental Allergy*, 41(7): 1031-1043
doi:10.1111/j.1365-2222.2011.03766.x

Laabs, E. *et al.* (2011) Optical Imaging of CCK2/Gastrin Receptor-Positive Tumors With a Minigastrin Near-Infrared Probe. *Investigative Radiology*, 46(3): 196-201
doi:10.1097/RLI.0b013e3181fef020

Rickert, KW. *et al.* (2011) Structural Basis for Selective Small Molecule Kinase Inhibition of Activated c-Met. *The Journal of Biological Chemistry*, 286: 11218-11225
doi:10.1074/jbc.M110.204404

Stuknyte, M. *et al.* (2011) Potential immunomodulatory activity of bovine casein hydrolysates produced after digestion with proteinases of lactic acid bacteria. *International Dairy Journal*, 21(10): 763-769
doi:10.1016/j.idairyj.2011.04.011

Nakano, E. *et al.* (2011) Riboflavin Depletion Impairs Cell Proliferation in Adult Human Duodenum: Identification of Potential Effectors. *Digestive Diseases and Sciences*, 56(4): 1007-1019
doi:10.1007/s10620-010-1374-3

Webb, K. *et al.* (2011) The ribosomal L1 protuberance in yeast is methylated on a lysine residue catalyzed by a seven beta-strand methyltransferase. *The Journal of Biological Chemistry*, 286(21): 18405-13
doi:10.1074/jbc.M110.200410

(Continued)

PLRP-S Citations

Uehata, T. *et al.* (2011) Serum hepcidin-25 levels and anemia in non-dialysis chronic kidney disease patients: a cross-sectional study. *Nephrology Dialysis Transplantation*, 27(3): 1076-1083
doi:10.1093/ndt/gfr431

Lohman, G, Chen, L. & Evans Jr, T. (2011) Kinetic characterization of single strand break ligation in duplex DNA by T4 DNA Ligase. *The Journal of Biological Chemistry*, 286: 44187-44196
doi:10.1074/jbc.M111.284992

Hudak, J., Yu, H. & Bertozzi, C. (2011) Protein Glycoengineering Enabled by the Versatile Synthesis of Aminoxy Glycans and the Genetically Encoded Aldehyde Tag. *Journal of the American Chemical Society*, 133(40): 16127-16135
doi:10.1021/ja206023e

Schneider, N. *et al.* (2011) Prevalence and stability of lysozyme in cheese. *Food Chemistry*, 128(1): 145-151
doi:10.1016/j.foodchem.2011.03.010

Yan, B. & Boyd, D. (2011) Breaking the Light and Heavy Chain Linkage of Human Immunoglobulin G1 (IgG1) by Radical Reactions. *The Journal of Biological Chemistry*, 286: 24674-24684
doi:10.1074/jbc.M111.255026

Landau, M. *et al.* (2011) Towards a Pharmacophore for Amyloid. *PLoS Biology*, 9(6)
doi:10.1371/journal.pbio.1001080

Kerkaert, B. *et al.* (2011) Use of lysozyme as an indicator of protein cross-contact in fresh-cut vegetables via wash waters. *Food Research International*, 45(1): 39-44
doi:10.1016/j.foodres.2011.10.007

Schneider, N., Werkmeister, K. & Pischetsrieder, M. (2011) Analysis of nisin A, nisin Z and their degradation products by LCMS/MS. *Food Chemistry*, 127(2): 847-854
doi:10.1016/j.foodchem.2011.01.023

Quenee, L. *et al.* (2011) Prevention of pneumonic plague in mice, rats, guinea pigs and non-human primates with clinical grade rV10, rV10-2 or F1-V vaccines. *Vaccine*, 29(38): 6572-6583
doi:10.1016/j.vaccine.2011.06.119

PL-SAX Citations

Linke, T. *et al.* (2012) Process scale separation of an anti-CD22 immunotoxin charge variant. *Journal of Chromatography A*, Volume 1260: 120-125
doi:10.1016/j.chroma.2012.08.061

Pratto, F. *et al.* (2008) Streptococcus pyogenes pSM19035 requires dynamic assembly of ATP-bound ParA and ParB on parS DNA during plasmid segregation. *Nucleic Acids Research*, 3 (11): 3676-3689
doi: 10.1093/nar/gkn170

Sendovski, M. *et al.* (2010) Crystallization and preliminary X-ray crystallographic analysis of a bacterial tyrosinase from *Bacillus megaterium*. *Acta Crystallographica*, 66(9): 1101-1103
doi:10.1107/S1744309110031520

Bunger, MK. *et al.* (2008) Automated Proteomics of *E. coli* via Top-Down Electron-Transfer Dissociation Mass Spectrometry. *Analytical Chemistry*, 80(5): 1459-1467
doi:10.1021/ac7018409

Vantourout, P. *et al.* (2009) Specific Requirements for V γ 9V δ 2 T Cell Stimulation by a Natural Adenylated Phosphoantigen. *The Journal of Immunology*, 183(6): 3848-3857
doi:10.4049/jimmunol.0901085

Scaboo, AM. *et al.* (2009) Confirmation of Molecular Markers and Agronomic Traits Associated with Seed Phytate Content in Two Soybean RIL Populations. *Crop Science*, 49(2): 426-432
doi:10.2135/cropsci2007.11.0614

PL-SCX Citations

Li, R. *et al.* (2013) Proteome and phosphoproteome analysis of honeybee (*Apis mellifera*) venom collected from electrical stimulation and manual extraction of the venom gland. *BMC Genomics* 2013, 14:766
doi:10.1186/1471-2164-14-766

Zhang, W. & Czupryn, M. (2003) Analysis of isoaspartate in a recombinant monoclonal antibody and its charge isoforms. *Journal of Pharmaceutical and Biomedical Analysis*, 30(5): 1479-1490
doi:10.1016/S0731-7085(02)00479-X

Collinge, J. *et al.* (2005) Differential Proteomics via Probabilistic Peptide Identification Scores. *Analytical Chemistry*, 77(2): 596-606
doi:10.1021/ac0488513

Schönleben, S. *et al.* (2007) Proteome analysis of *Apis mellifera* royal jelly. *Analytical and Bioanalytical Chemistry*, 389(4): 1087-1093
doi:10.1007/s00216-007-1498-2

Lohaus, C. *et al.* (2007) Multidimensional Chromatography: a Powerful Tool for the Analysis of Membrane Proteins in Mouse Brain. *Journal of Proteome Research*, 6(1): 105-113
doi:10.1021/pr060247g

Zahedi, RP. *et al.* (2007) Phosphoproteome of Resting Human Platelets. *Journal of Proteome Research*, 7(2): 526-534
doi:10.1021/pr0704130

Boehm, A. *et al.* (2007) Precise protein quantification based on peptide quantification using iTRAQ™. *BMC Bioinformatics*, 8: 214
doi:10.1186/1471-2105-8-214

Heller, M. *et al.* (2003) Trypsin catalyzed ¹⁶O-to-¹⁸O exchange for comparative proteomics: tandem mass spectrometry comparison using MALDI-TOF, ESI-QTOF, and ESI-ion trap mass spectrometers. *Journal of the American Society for Mass Spectrometry*, 14(7): 704-718
doi:10.1016/S1044-0305(03)00207-1

Poroshell 300 Citations

- Blakemore, W. *et al.* (2014) Carrageenan analysis. Part 2: Quantification in swine-adapted infant formula. *Food Additives & Contaminants: Part A*, 31(10): 1670-1672
doi:10.1080/19440049.2014.955537
- Lesellier, E. (2012) Efficiency in supercritical fluid chromatography with different superficially porous and fully porous particles ODS bonded phases. *Journal of Chromatography A*, 1228(3): 89-98
doi:10.1016/j.chroma.2011.11.058
- Martosella, J., Duong, P. (2012) Ultra-fast Protein Separations and High Efficiency Peptide Profiling with Agilent LC Columns. *LCGC Application Notebook*, Sept 1
- Muniguntti, R., Calderón, AI. (2012) Development of liquid chromatography/mass spectrometry based screening assay for PflTrxR inhibitors using relative quantitation of intact thioredoxin. *Rapid Communications in Mass Spectrometry*, 26(17): 1097-1231
doi:10.1002/rcm.6316
- Wang, F., Min, Y., Geng, X. (2012) Fast separations of intact proteins by liquid chromatography. *Journal of Separation Science*, 35(22): 1615-9314
doi:10.1002/jssc.201200339
- Jing Y. *et al.* (2012) Gambogic Acid Deactivates Cytosolic and Mitochondrial Thioredoxins by Covalent Binding to the Functional Domain. *Journal of Natural Products*, 75(6): 1108-1116
doi:10.1021/np300118c
- Matilainen, L. *et al.* (2008) The effect of cyclodextrins on chemical and physical stability of glucagon and characterization of glucagon/ γ -CD inclusion complexes. *Journal of Pharmaceutical Sciences*, 97(7): 2720-2729
doi:10.1002/jps.21209
- Astarita, G., Ahmed, F. & Piomelli, D. (2008) Identification of biosynthetic precursors for the endocannabinoid anandamide in the rat brain. *The Journal of Lipid Research*, 49: 48-57
doi:10.1194/jlr.M700354-JLR200

(Continued)

Poroshell 300 Citations

- Matilainen, L. *et al.* (2008) The stability and dissolution properties of solid glucagon/ γ -cyclodextrin powder. *European Journal of Pharmaceutical Sciences*, 36(4-5): 412-420
doi:10.1016/j.ejps.2008.11.006
- Wang, Y. *et al.* (2009) Comparison of Methods for Extracting Kafirin Proteins from Sorghum Distillers Dried Grains with Solubles. *Journal of Agricultural & Food Chemistry*, 57(18): 8366-8372
doi:10.1021/jf901713w
- Guerrera, IC. *et al.* (2009) A Novel Lipidomic Strategy Reveals Plasma Phospholipid Signatures Associated with Respiratory Disease Severity in Cystic Fibrosis Patients. *PLoS ONE*, 4(11): e7735
doi:10.1371/journal.pone.0007735
- Yung, KM. *et al.* (2011) An amyloid β_{42} -dependent deficit in anandamide mobilization is associated with cognitive dysfunction in Alzheimer's disease. *Neurobiology of Aging*, 33(8): 1522-32
doi:10.1016/j.neurobiolaging.2011.03.012
- Reid, CO. *et al.* (2010) Rapid whole monoclonal antibody analysis by mass spectrometry: An Ultra scale-down study of the effect of harvesting by centrifugation on the post-translational modification profile. *Biotechnology and Bioengineering*, 107(1): 85-95
doi:10.1002/bit.22790
- Heinig, K. & Wirz, T. (2009) Determination of Taspoglutide in Human and Animal Plasma Using Liquid Chromatography – Tandem Mass Spectrometry with Orthogonal Column-Switching. *Analytical Chemistry*, 81(10): 3705-3713
doi:10.1021/ac900422e
- Rossi, EA. *et al.* (2010) A Bispecific Antibody-IFN α 2b Immunocytokine Targeting CD20 and HLA-DR Is Highly Toxic to Human Lymphoma and Multiple Myeloma Cells. *Cancer Research*, 70: 7600
doi:10.1158/0008-5472.CAN-10-2126
- Murphy, MP. *et al.* (2010) Changes in Cognition and Amyloid- β Processing with Long Term Cholesterol Reduction using Atorvastatin in Aged Dogs. *Journal of Alzheimer's Disease*, 22(1): 135-150
doi:10.3233/JAD-2010-100639

ZORBAX 300 Citations

Gao, J. *et al.* (2014) Absolute Quantification of Histone PTM Marks by MRM-Based LC-MS/MS. *Analytical Chemistry*, 86 (19): 9679-9686
doi:10.1021/ac502333a

Huang, Y. *et al.* (2014) Role of helicity of α -helical antimicrobial peptides to improve specificity. *J Protein & Cell*, 5 (8): 631-642
doi:10.1007/s13238-014-0061-0

Huang, Y. *et al.* (2014) Comparison of the Effects of Acarbose and TZQ-F, a New Kind of Traditional Chinese Medicine to Treat Diabetes, Chinese Healthy Volunteers. *Evidence-Based Complementary and Alternative Medicine*, 9 pages
doi:10.1155/2014/308126

Juanjuan, T. *et al.* (2014) Effects of Single Amino Acid Substitution on the Biophysical Properties and Biological Activities of an Amphipathic α -Helical Antibacterial Peptide Against Gram-Negative Bacteria. *Molecules*, 19(8): 10803-10817 doi:10.3390/molecules190810803

Jiang, Z. *et al.* (2014) Specificity Determinants Improve Therapeutic Indices of Two Antimicrobial Peptides Piscidin 1 and Dermaseptin S4 against the Gram-negative Pathogens *Acinetobacter baumannii* and *Pseudomonas aeruginosa*. *Pharmaceuticals*, 7(4): 366-391
doi:10.3390/ph7040366

Lu, C. *et al.* (2014) Microwave-assisted acid hydrolysis of proteins combined with peptide fractionation and mass spectrometry analysis for characterizing protein terminal sequences. *Journal of Proteomics*, 100(4): 68-78
doi:10.1016/j.jprot.2013.10.014

Sharma, D. *et al.* (2014) Purification and characterization of a novel lipopeptide from *Streptomyces amritsarensis* sp. nov. active against methicillin-resistant *Staphylococcus aureus*. *AMB Express*, 4:50
doi:10.1186/s13568-014-0050-y

Piras, C. *et al.* (2014) Serum protein profiling of early and advanced stage Crohn's disease. *EuPA Open Proteomics*, 3: 48-59
doi:10.1016/j.euprot.2014.02.010

Xiong, Y. *et al.* (2014) Differential expression of synaptic proteins in unilateral 6-OHDA lesioned rat model – A comparative proteomics approach. *Proteomics*, 14 (15): 1808-1819
doi:10.1002/pmic.201400069

(Continued)

ZORBAX 300 Citations

Bräutigam, J., Scheidig, A. & Egge-Jacobsen, W. (2013) Mass spectrometric analysis of hepatitis C viral envelope protein E2 reveals extended microheterogeneity of mucin-type O-linked glycosylation. *Glycobiology*, 23 (4): 453-474
doi:10.1093/glycob/cws171

Portelius, E. *et al.* (2007) Characterization of Amyloid β Peptides in Cerebrospinal Fluid by an Automated Immunoprecipitation Procedure Followed by Mass Spectrometry. *Journal of Proteome Research*, 6 (11): 4433-4439
doi:10.1021/pr0703627

Montes-Bayon, M. *et al.* (2006) Direct comparison of capillary electrophoresis and capillary liquid chromatography hyphenated to collision-cell inductively coupled plasma mass spectrometry for the investigation of Cd-, Cu- and Zn-containing metalloproteins. *Journal of Chromatography A*, 1114(1): 138-144
doi:10.1016/j.chroma.2006.02.028

Zahariev, S. *et al.* (2006) Synthesis of 'difficult' peptides free of aspartimide and related products, using peptoid methodology. *Tetrahedron Letters*, 47(25): 4121-4124
doi:10.1016/j.tetlet.2006.04.074

Kohler, M. *et al.* (2009) Identification of Human Pituitary Growth Hormone Variants by Mass Spectrometry. *Journal of Proteome Research*, 8(2): 1071-1076
doi:10.1021/pr800945b

Berg, M. *et al.* (2006) Reproducibility of LC-MS-based protein identification. *Journal of Experimental Botany*, 57(7): 1509-1514
doi:10.1093/jxb/erj139

Esteban-Fernández, D. *et al.* (2008) Atomic (HPLC-ICP-MS) and molecular mass spectrometry (ESI-Q-TOF) to study cis-platin interactions with serum proteins. *Journal of Analytical Atomic Spectrometry*, 23: 378-384
doi:10.1039/B711922D

Everberg, H. *et al.* (2006) Aqueous Two-Phase Partitioning for Proteomic Monitoring of Cell Surface Biomarkers in Human Peripheral Blood Mononuclear Cells. *Journal of Proteome Research*, 5(5): 1168-1175
doi:10.1021/pr050469z

(Continued)

ZORBAX 300 Citations

Portelius, E. *et al.* (2010) Identification of novel N-terminal fragments of amyloid precursor protein in cerebrospinal fluid. *Experimental Neurology*, 223(2): 351-358

doi:10.1016/j.expneurol.2009.06.011

Ahrends, R. *et al.* (2009) Metal-Coded Affinity Tag Labeling: A Demonstration of Analytical Robustness and Suitability for Biological Applications. *Analytical Chemistry*, 81(6): 2176-2184

doi:10.1021/ac802310c

Bíliková, K. *et al.* (2009) Towards functional proteomics of minority component of honeybee royal jelly: The effect of post-translational modifications on the antimicrobial activity of apalbumin2. *Proteomics*, 9(8): 2131-2138

doi:10.1002/pmic.200800705

Schwab, K. *et al.* (2011) Adaptation of proteomic techniques for the identification and characterization of protein species from murine heart. *Amino Acids*, 41(2): 401-414

doi:10.1007/s00726-010-0675-3

Perreault, A. *et al.* (2009) A Methyltransferase-independent Function for Rmt3 in Ribosomal Subunit Homeostasis. *The Journal of Biological Chemistry*, 284: 15026-15037

doi:10.1074/jbc.M109.004812

Magherini, F. *et al.* (2009) Different carbon sources affect lifespan and protein redox state during *Saccharomyces cerevisiae* chronological ageing. *Cellular and Molecular Life Sciences*, 66(5): 933-947

doi:10.1007/s00018-009-8574-z

Cao H. & Xu S-Y. (2008) Purification and characterization of type II collagen from chick sternal cartilage. *Food Chemistry*, 108(2): 439-445

doi:10.1016/j.foodchem.2007.09.022

Chen, X. *et al.* (2010) Quantitative Proteomics Analysis of Cell Cycle-regulated Golgi Disassembly and Reassembly. *The Journal of Biological Chemistry*, 285: 7197-7207

doi:10.1074/jbc.M109.047084

Trusch, M. *et al.* (2010) Application of displacement chromatography for the analysis of a lipid raft proteome. *Journal of Chromatography B*, 878(3-4): 309-314

doi:10.1016/j.jchromb.2009.11.035

Amoresano, A. *et al.* (2008) A Rapid and Selective Mass Spectrometric Method for the Identification of Nitrated Proteins. *Methods in Molecular Biology*, 477(1): 15-29

(Continued)

ZORBAX 300 Citations

Kodali, VP., Das, S. & Sen, R. (2009) An exopolysaccharide from a probiotic: Biosynthesis dynamics, composition and emulsifying activity. *Food Research International*, 42(5-6): 695-699

doi:10.1016/j.foodres.2009.02.007

Loeber, R. *et al.* (2008) Cross-Linking of the DNA Repair Protein O⁶-Alkylguanine DNA Alkyltransferase to DNA in the Presence of Antitumor Nitrogen Mustards. *Chemical Research in Toxicology*, 21(4): 787-795

doi:10.1021/tx7004508

Millette, M. *et al.* (2008) Purification and identification of the pediocin produced by *Pediococcus acidilactici* MM33, a new human intestinal strain. *Journal of Applied Microbiology*, 104(1): 269-275

doi:10.1111/j.1365-2672.2007.03583.x

Chen, X. *et al.* (2009) Quantitative Organellar Proteomics Analysis of Rough Endoplasmic Reticulum from Normal and Acute Pancreatitis Rat Pancreas. *Journal of Proteome Research*, 9(2): 885-896

doi:10.1021/pr900784c

Ameri, M., Daddona, P. & Maa, YF. (2009) Demonstrated Solid-State Stability of Parathyroid Hormone PTH(1-34) Coated on a Novel Transdermal Microprojection Delivery System. *Pharmaceutical Research*, 26(11): 2454-2463

doi:10.1007/s11095-009-9960-9

Gianazza, E. *et al.* (2010) Different expression of Fibrinopeptide A and related fragments in serum of type 1 diabetic patients with nephropathy. *Journal of Proteomics*, 73(3): 593-601

doi:10.1016/j.jprot.2009.07.006

Yuan, W. *et al.* (2008) Two New Holostan-Type Triterpene Glycosides from the Sea Cucumber *Bohadschia marmorata* JAEGER. *Chemical & Pharmaceutical Bulletin*, 56(8): 1207

doi:10.1248/cpb.56.1207

TIPS & TOOLS

These are just recent examples of citations on Agilent biocolumns. For additional information on biocolumns or other topics, contact Agilent Technical Support.



Agilent 1260 Infinity Bio-inert Quaternary LC

Infinitely Better for Biomolecule Analysis

Proteins are susceptible to many interactions during analysis, so use the Agilent 1260 Infinity Bio-inert Quaternary LC for a completely interference-free flow path with your biochromatography. The pump head and mixing devices are titanium-based which means no corrosion will occur. The autosampler is completely metal-free, as well as the capillaries, connections, detector flow cells, and heating elements. The pH range extends to pH 13, active sealwash is included, and low-pressure applications are also possible.

You can expand the capability of your 1260 Infinity Bio-inert Quaternary LC by adding optional extras. When you want to purify your target protein the bio-inert fraction collector can be used for flows up to 10 mL/min, with a cooling option and sophisticated peak trigger options. The manual injector is ideal for larger volume injections. Bio-inert flow cells are available for diode array detectors, multi-wavelength detectors, and fluorescence detectors.

Learn more at www.agilent.com/chem/bio-inert

Custom Columns and Bulk Media Ordering

Whilst this guide provides details of many columns and media, we understand that you may need a specific column or quantity of media. If you do not see the combination of pore/particle size and column dimensions or the bulk media quantity you are looking for in this guide, please contact your local sales office, for assistance with our custom ordering process.

For more information

Learn more:

www.agilent.com/chem/biohplc

Buy online:

www.agilent.com/chem/store

U.S. and Canada

1-800-227-9770

agilent_inquiries@agilent.com

Europe

info_agilent@agilent.com

Asia Pacific

inquiry_lsca@agilent.com

This information is subject to change without notice.

© Agilent Technologies, Inc. 2015
Published in February 2015
5990-9384EN

