

OMNIS Magnetic Stirrer

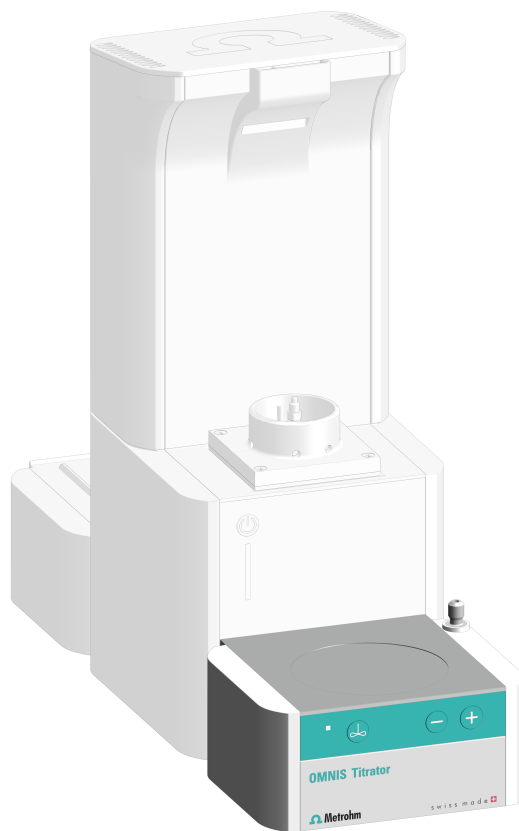

2.1005.0010

Product information

8.1005.8001EN / 2021-07-23



Metrohm AG
Ionenstrasse
CH-9100 Herisau
Switzerland
+41 71 353 85 85
info@metrohm.com
www.metrohm.com

OMNIS Magnetic Stirrer

2.1005.0010

Product information

8.1005.8001EN /
2021-07-23

Technical Communication
Metrohm AG
CH-9100 Herisau

This documentation is protected by copyright. All rights reserved.

This documentation has been prepared with great care. However, errors can never be entirely ruled out. Please send comments regarding possible errors to the address above.

Disclaimer

Deficiencies arising from circumstances that are not the responsibility of Metrohm, such as improper storage or improper use, etc., are expressly excluded from the warranty. Unauthorized modifications to the product (e.g. conversions or attachments) exclude any liability on the part of the manufacturer for resulting damage and its consequences. Instructions and notes in the Metrohm product documentation must be strictly followed. Otherwise, Metrohm's liability is excluded.

Table of contents

1	Overview	1
1.1	Magnetic stirrer – Product description	1
1.2	Magnetic stirrer – Overview	1
1.3	Magnetic stirrer with accessories – Overview	2
1.4	Symbols and conventions	3
1.5	Further information	3
1.6	Accessories	3
2	Safety	5
2.1	Intended use	5
2.2	Responsibility of the operator	5
2.3	Requirements for operating personnel	6
2.4	Safety instructions	6
2.4.1	Danger from electrical potential	6
2.4.2	Danger from biological and chemical hazardous substances	6
2.4.3	Danger from highly flammable substances	7
2.4.4	Danger from leaking liquids	7
2.4.5	Danger during transport of the product	8
2.5	Design of warning messages	8
2.6	Meaning of warning signs	9
3	Technical specifications	11
3.1	Ambient conditions	11
3.2	Magnetic stirrer – Energy supply	11
3.3	Magnetic stirrer – Dimensions	11
3.4	Magnetic stirrer – Housing	11
3.5	Display specifications	12
3.6	Magnetic stirrer – Specifications	12

1 Overview

1.1 Magnetic stirrer – Product description

The magnetic stirrer allows you to stir the sample and other liquids at different speeds and in different directions.

The magnetic stirrer is integrated in some versions of the OMNIS Titrator, the OMNIS Titration Module and the OMNIS Dosing Module.

The other versions can be retrofitted with a magnetic stirrer as required.

1.2 Magnetic stirrer – Overview

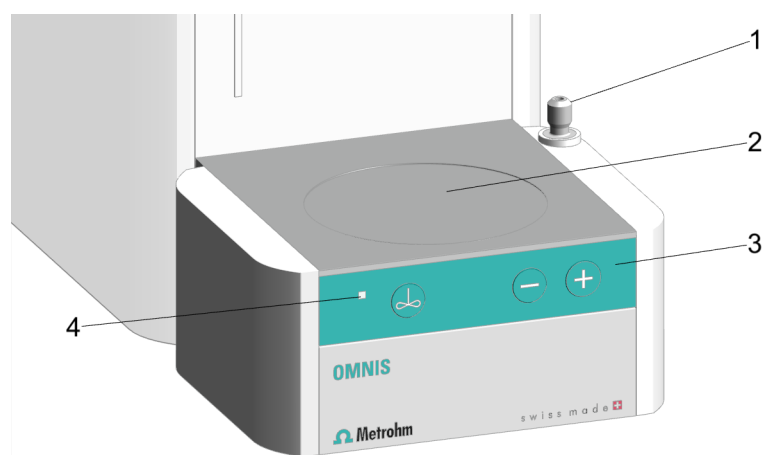

Figure 1 Magnetic stirrer – Overview

1	Stand attachment	2	Stirring area
3	Control bar	4	Status display LED. Multi-colored



1.3 Magnetic stirrer with accessories – Overview

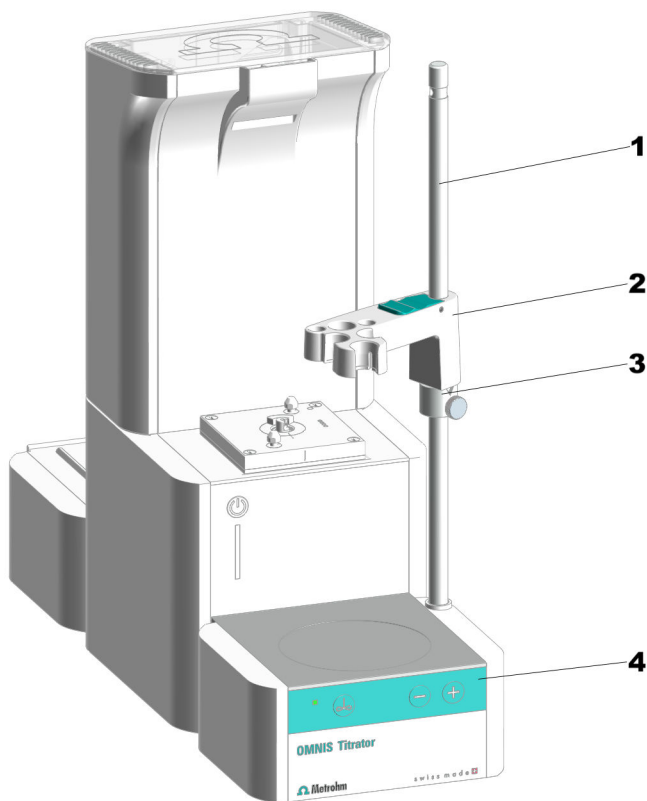

Figure 2 Magnetic stirrer with accessories – Overview

1 Support rod	2 Electrode holder
3 Clamping ring	4 Control bar



NOTICE

The support rod is grounded. The OMNIS Titrator and OMNIS Titration Module have a hole in the support rod that serves as earth contact for a banana plug (4 mm).

1.4 Symbols and conventions

The following formatting may appear in the documentation:

(5-12)	Cross-reference to figure legend The first number refers to the figure number. The second number refers to the product part in the figure.
1	Instruction step Numbers indicate the order of the instructions steps.
Method	Names of parameters, menu items, tabs and dialog windows
File ► New	Menu path
[Continue]	Button or key

1.5 Further information

The Metrohm Knowledge Base <https://guide.metrohm.com> always provides the current version of this document. Further instructions, leaflets, release notes etc. may be available, depending on the product. You can directly access the required information or the associated PDF document using the full-text search function and filters.

1.6 Accessories

Up-to-date information on the scope of delivery and on optional accessories can be found on the Metrohm website. Download this information as follows:

Downloading the accessories list

- 1** Go to <https://www.metrohm.com>.
- 2** Enter the article number of the product (e.g. **2.1001.0010**) into the search field.
The search result is displayed.
- 3** Click on the product.
Detailed information regarding the product is shown on various tabs.



- 4 On the **Included parts** tab, click the link to download the PDF.
The PDF file with the accessories data is loaded.



NOTICE

Metrohm recommends downloading the accessories list from the Internet and keeping it for reference purposes.

2 Safety

2.1 Intended use

Metrohm products are used for the analysis and handling of chemicals.

Usage therefore requires the user to have basic knowledge and experience in handling chemicals. Knowledge regarding the application of fire prevention measures prescribed for laboratories is also mandatory.

Adherence to this technical documentation and compliance with the maintenance specifications make up an important part of intended use.

Any utilization in excess of or deviating from the intended use is regarded as misuse.

Specifications regarding the operating values and limit values of individual products are contained in the "Technical specifications" section, if relevant.

Exceeding and/or not observing the mentioned limit values during operation puts people and components at risk. The manufacturer assumes no liability for damage due to non-observance of these limit values.

The EU declaration of conformity loses its validity as soon as modifications are carried out on the products and/or the components.

2.2 Responsibility of the operator

The operator must ensure that basic regulations on occupational safety and accident prevention in chemical laboratories are observed. The operator has the following responsibilities:

- Instruct personnel in the safe handling of the product.
- Train personnel in the use of the product according to the user documentation (e.g. install, operate, clean, eliminate faults).
- Train staff on basic occupational safety and accident prevention regulations.
- Provide personal protective equipment (e.g. protective glasses, gloves).
- Provide suitable tools and equipment to carry out the work safely.

The product may be used only when it is in perfect condition. The following measures are required to ensure the safe operation of the product:

- Check the condition of the product before use.
- Remedy defects and malfunctions immediately.
- Maintain and clean the product regularly.

- Label the product according to regulations if it is used for substances that have a potential for chemical hazards and are generally subject to the Hazardous Substances Ordinance.
- Wear personal protective equipment (e.g. protective glasses, gloves).
- Use exhaust equipment when working with vaporizing hazardous substances.
- Dispose of hazardous substances in accordance with regulations.
- Clean and disinfect contaminated surfaces.
- Only use detergents that do not cause any unwanted side reactions with the materials to be cleaned.
- Dispose of chemically contaminated materials (e.g. cleaning material) in accordance with regulations.
- Proceed as follows in case of a return shipment to Metrohm AG or a regional Metrohm representative:
 - Decontaminate the product or product component.
 - Remove the labeling for hazardous substances.
 - Create a declaration of decontamination and enclose it with the product.

2.4.3 Danger from highly flammable substances

Using highly flammable substances or gases may cause fires or explosions. To avoid danger from highly flammable substances, observe the following:

- Avoid ignition sources.
- Use protective grounding.
- Use exhaust equipment.

2.4.4 Danger from leaking liquids

Leaking liquids may cause injuries and may damage the product. To avoid danger from leaking liquids, observe the following:

- Check the product and its accessories for leakages and loose connections.
- Replace leaking parts and connecting elements without delay.
- Tighten loose connecting elements.
- Do not loosen tubing connections under pressure.
- Do not remove aspiration tubing under pressure.
- Carefully pull the ends of the tubing out of the containers.
- Carefully let liquids from tubing drain into suitable containers.
- Insert the buret tips completely into the containers.
- Remove and dispose of leaked liquids in accordance with regulations.
- If you suspect that liquid has penetrated the instrument, disconnect the instrument from the energy supply. Then have the instrument checked by a regional Metrohm service representative.



WARNING

Type or source of danger

Consequences when not observing the notice: A serious injury that may result in death is probable.

- Measures to avoid the danger



CAUTION

Type or source of danger

Consequences when not observing the notice: A minor to moderate injury is probable.

- Measures to avoid the danger





2.6 Meaning of warning signs

This documentation uses the following warning signs:

Table 1 Warning sign according to ISO 7010

Warning sign	Meaning
	General warning sign
	Warning of electrical voltage
	Warning of hand injuries
	Warning of sharp object
	Warning of hot surface
	Warning of biological hazard
	Warning of toxic materials



Warning sign	Meaning
	Warning of flammable materials
	Warning of corrosive substances
	Warning of optical radiation
	Warning of laser beams

Depending on the intended use of the product, the corresponding warning sign stickers must be placed on the product.

3 Technical specifications

3.1 Ambient conditions

Nominal function range	+5 to +45 °C	at max. 80% relative humidity, non- condensing
Storage	+5 to +45 °C	

3.2 Magnetic stirrer – Energy supply

Nominal voltage	24 VDC	internal
------------------------	--------	----------

3.3 Magnetic stirrer – Dimensions

Measurements

<i>Width</i>	142 mm
<i>Height</i>	70 mm
<i>Depth</i>	116 mm
Weight	700 g

3.4 Magnetic stirrer – Housing

Materials

<i>Cover</i>	PBT	poly(butylene terephthalate)
<i>Base</i>		chromium steel
<i>Enclosure</i>	PBT	poly(butylene terephthalate)
<i>Front foils</i>	PET	poly(butylene terephthalate), mat
IP degree of protection	IP 40	



3.5 Display specifications

Status display LED multi-colored

3.6 Magnetic stirrer – Specifications

OMNIS product version with attached magnetic stirrer

Adjustment range for rotational speed +1 to +15 Rotation in counter-clockwise direction (seen from above)

-1 to -15 Rotation in clockwise direction (seen from above)

Rotational speed change per step 120 rpm

Maximum rotational speed 1,800 rpm

Stirring bar lengths 8, 12, 16, 25, 30 mm