

# Analysis of Trace (mg/kg) Thiophene in Benzene Using Two-Dimensional Gas Chromatography and Flame Ionization Detection

Application

Petrochemical

## Authors

James D. McCurry and Bruce D. Quimby  
Agilent Technologies  
2850 Centerville Road  
Wilmington, DE 19808-1610  
USA

## Abstract

**A two-dimensional gas chromatography system using a simplified Deans switch design is used for the analysis of trace (mg/kg) thiophene in benzene. This system uses two GC columns of different selectivity, INNOWax and PLOT Q, to completely separate the thiophene from the interfering sample matrix. Because of this high resolution, standard flame ionization detectors can be used in place of more expensive and complex sulfur selective detectors. The system provides precise qualitative and quantitative analyses results that are in agreement with those using sulfur selective detectors. This versatile system can also perform a standard American Society for Testing and Materials benzene purity analysis at the same time the thiophene measurement is made.**

## Introduction

Benzene is an important feedstock for the production of a number of key commodity chemicals. Many of these processes use expensive catalysts that can be easily poisoned by small amounts of

sulfur containing impurities. In an effort to reduce costs, improve efficiency, and increase product quality, the sulfur specifications in benzene have been continuously lowered. Thiophene is a common sulfur impurity found in benzene and is difficult to analyze by gas chromatography (GC) at trace levels (mg/kg). This is because thiophene is an aromatic compound with a boiling point and molecular weight that is similar to benzene, therefore it has nearly the same chromatographic behavior as benzene. Successful GC analysis of thiophene has been performed using non-quenching selective detectors such as sulfur chemiluminescence (SCD) and atomic emission detectors (AED) [1]. However, these detectors are expensive and much more complex than a flame ionization detector (FID).

Two-dimensional gas chromatography (2-D GC) offers another approach to this analysis. Two columns of different selectivity can be combined to completely separate thiophene from benzene and other chromatographic interferences. Once the thiophene is completely separated from the large benzene peak, it can be easily detected using an FID. The keys to successful 2-D GC analysis are the column selection and the device that couples together the two columns. A 2-D GC system developed for the analysis of oxygenates and aromatics in gasoline uses a simplified Deans switch as the column-coupling device [2]. This application note describes a 2-D GC application using a similar Deans switch system for the analysis of trace thiophene in pure benzene.



Agilent Technologies

## Experimental

An Agilent 6890N gas chromatograph was equipped with a split/splitless injector, a pneumatics control module (PCM), two FIDs, and an automatic liquid sampler (ALS). An HP-INNOWax column was used as the primary column and an HP-PLOT Q was used as the secondary column. The two columns were linked using a simplified fluidic Deans switch. Figure 1 shows the instrument configuration using this hardware and Table 1 lists the details of the hardware configuration. The instrument operating conditions are outlined in Table 2 for this analysis. For all standards and samples, the injection volume was 4  $\mu\text{L}$ .

Determination of electronic pressure control (EPC) pressures, flow rates, and the fixed restrictor dimensions were performed using a Deans switch calculator software program that is specially designed for this system. This calculator program is included with the Deans switch hardware option

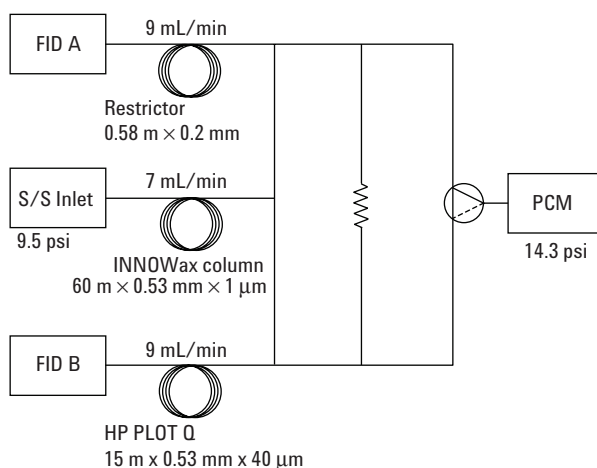

**Figure 1.** Deans switch configuration for the analysis of trace thiophene in benzene with an FID. A preliminary separation is performed using the primary INNOWax column. The thiophene peak is heart-cut from the INNOWax column to the secondary HP-PLOT Q column. Complete separation of the thiophene from benzene is then performed on the PLOT Q column.

**Table 1. Agilent 6890 Hardware Configuration for 2-D GC**

<b>Standard 6890N GC hardware</b>	
G1540N	Agilent 6890N Series GC
Option 112	Capillary split/splitless inlet with EPC control
Option 210 (2 of each)	FID with EPC control
Option 309	Pneumatics control module with EPC control
SP1 2310-0129	General purpose Deans switch kit, factory installed (may be ordered as an add-on kit for existing 6890 GC Agilent part no. G2855A)
G2613A	Agilent 7683 Autoinjector
<b>Columns</b>	
Primary column	INNOWax column, 1.00 $\mu\text{m}$ film, 60 m $\times$ 0.53 mm id (Agilent part no. 19095N-126)
Secondary column*	HP PLOT Q column, 40 $\mu\text{m}$ film, 15 m $\times$ 0.53 mm id (Agilent part no. 19095P-Q03)
Fixed restrictor*	Deactivated fused silica tubing, 0.58 m $\times$ 0.2 mm id (Agilent part no. 160-2205-10)
<b>Data system</b>	
G2070A	Agilent Multitechnique ChemStation
<b>Other consumables</b>	
Agilent part no. 5181-1267	10- $\mu\text{L}$ Fixed tapered needle autoinjector syringe
Agilent part no. 5183-4647	Inlet liner optimized for splitless operation
Agilent part no. 5183-4759	Advanced green septa

\*The Deans switch calculator was used to determine the correct EPC pressures for column flows and the dimensions of the fixed restrictor. Since the film thickness of the PLOT Q column is large (40  $\mu\text{m}$ ), the effective id of this column was reduced to 0.45  $\mu\text{m}$  for the purpose of determining the column pressures and flows.

**Table 2. Instrument Conditions**

Injection port	Splitless mode
Temperature	200 °C
Pressure*	14.33 psi helium, constant pressure mode
Purge time	0.75 min.
Purge flow	100 mL/min
Injection size	2 µL–4 µL, splitless
INNOWax column flow	7 mL/min, constant pressure mode
Pneumatics control module (PCM)*	9.46 psi helium, constant pressure mode
HP PLOT Q column flow	9 mL/min
FID temperatures	250 °C
Oven temperature program:	
Initial temp	60 °C for 1 min
Ramp #1	25 °C/min to 80 °C for 9 min
Ramp #2	50 °C/min to 140 °C for 9 min
Ramp #3	35 °C/min to 225 °C for 0 min

\*These pressures were calculated using a custom Deans switch software program to achieve the necessary column flow rates.

for the Agilent 6890N GC. All instrument set points required for any successful 6890N based Deans switch application can be quickly and easily determined using this software.

For the preparation of calibration standards, HPLC grade 99.9+% benzene (Sigma-Aldrich part no. 27,070-9) and 99+% thiophene (Sigma-Aldrich part no. T3,180-1) were used. The HPLC grade benzene was selected because it contained less than 0.003 mg/kg of thiophene contamination. This benzene was further purified by a three-step recrystallization. Calibration standards were prepared in the purified benzene that contained 0.02, 0.05, 0.1, 0.2, 0.5, 1, and 2 mg/kg of thiophene in benzene.

Heart-cut times for this analysis were determined by injecting the 2 mg/kg calibration standard into the 2-D GC system while keeping the fluidic switch in the “off” position. This allowed the standard to be separated only with the primary INNOWax column and detected using FID A (Figure 1). From this chromatogram, the cut times for thiophene were calculated using the peak start and end times.

A second gas chromatograph with an atomic emission detector (GC-AED) was used to perform a crosscheck to the 2-D GC system for the analysis of thiophene. The GC-AED was equipped with the same INNOWax capillary column listed in Table 1 and the AED was configured for sulfur selective detection. The GC-AED was also used to evaluate the thiophene content in the benzene used as a blank and for the calibration standards.

## Results and Discussion

**Heart-cut time setting** – The 2 mg/kg calibration standard was run 12 times over a 24-hour period with no heart cutting. This established the retention time (RT) precision of the thiophene peak on the INNOWax column so that the heart-cut time could be determined. Figure 2 shows an overlay of these 12 chromatograms. The average RT for thiophene was 8.055 minutes with a relative standard deviation of 0.1%. The average peak start time was 7.995 minutes (%RSD = 0.1) and the average peak end time was 8.137 minutes (%RSD = 0.1). With this high degree of RT precision, a narrow heart-cut between 7.95 and 8.18 minutes was used

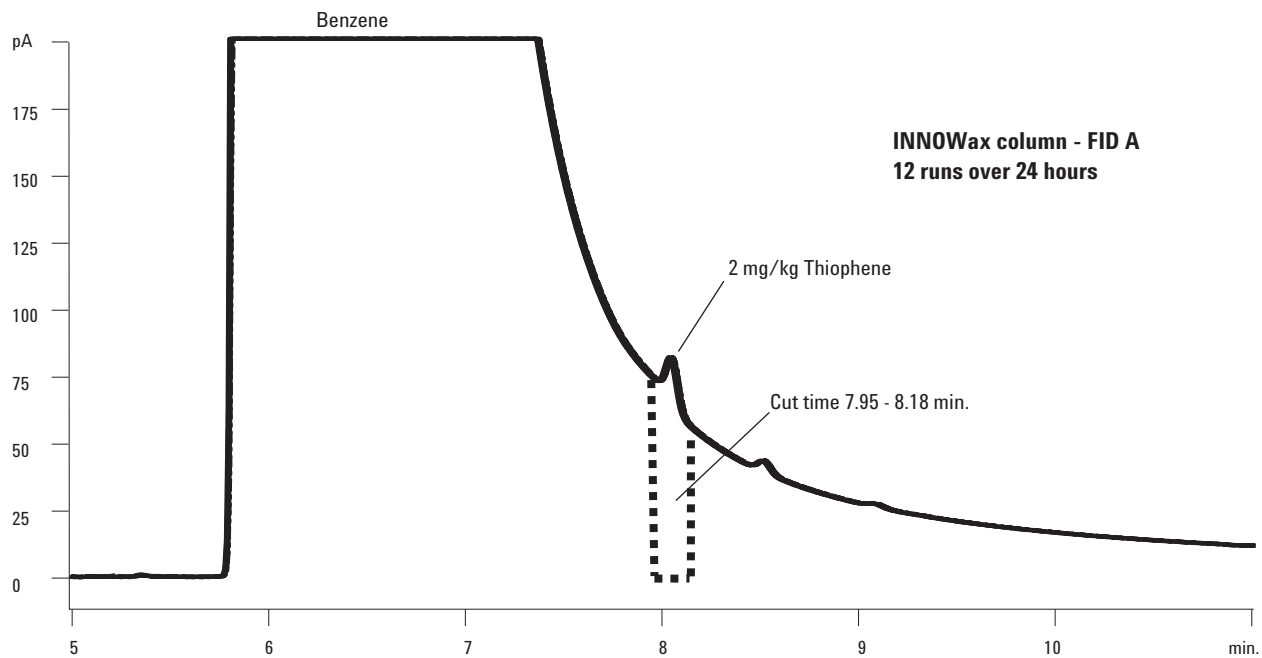

**Figure 2.** Twelve separate runs of the 2 mg/kg thiophene standard were made over a 24-hour period. The excellent RT precision allows a narrow heart-cut time from 7.95 to 8.18 min for the thiophene peak.

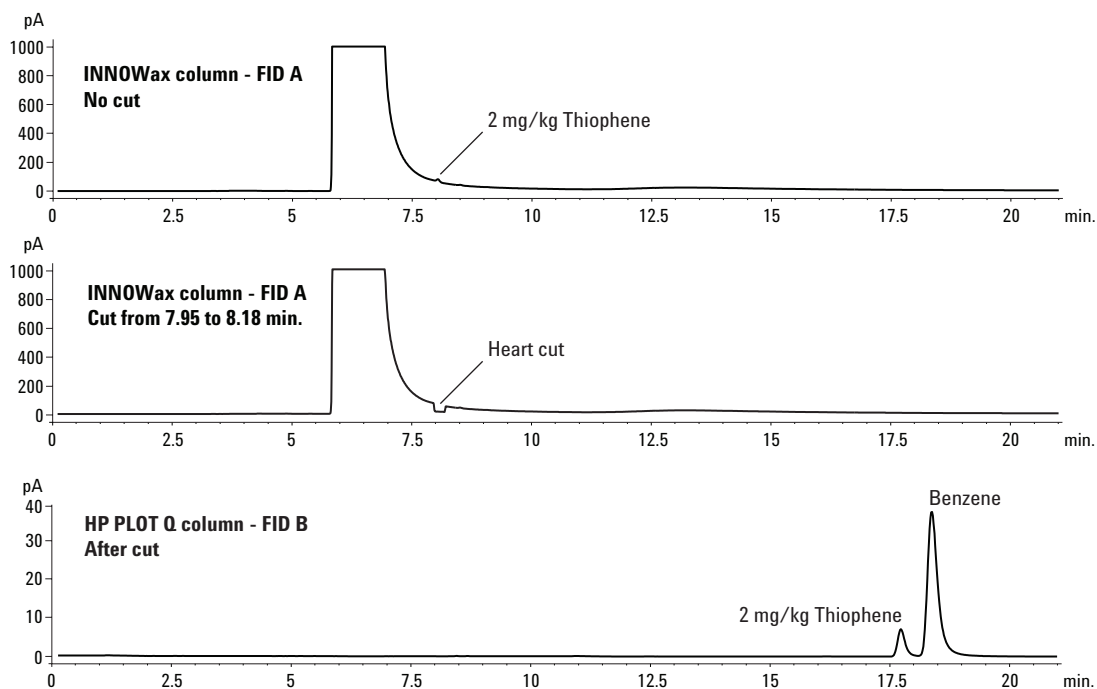

**Figure 3.** The upper chromatogram shows the 2 mg/kg standard separated on the INNOWax column with no heart cutting. In the middle chromatogram, the Deans switch transfers the INNOWax column eluent to the HP-PLOT Q column. The lower chromatogram shows the separation of this heart cut on the PLOT Q column. Note that the thiophene is well separated from the benzene matrix and elutes before the benzene on the PLOT Q column.

to transfer the thiophene peak from the INNOWax column to the PLOT Q column. The dimensions of the fixed restrictor were determined using the Deans switch calculator software to give a negligible hold-up time (0.002 minutes) from the INNOWax column to FID A. Therefore, the measured peak start and end times can be directly used to determine the heart-cut window.

Using this cut window, the 2 mg/kg standard was run on the 2-D GC system so that the thiophene peak was automatically cut from the INNOWax column to the HP-PLOT Q column (Figure 3). Since thiophene is not completely separated from the large benzene peak on the INNOWax column, a portion of the benzene peak was also cut to the HP-PLOT Q column. After transfer to the PLOT Q column, the thiophene was completely separated from the residual benzene (Figure 3). The selectivity of the PLOT Q column was quite different from the INNOWax column. This is shown in Figure 3 where the thiophene peak was observed to elute before the benzene peak on the PLOT Q column. Having the thiophene elute first also made peak integration easier since the small thiophene peak was not eluting in benzene tail.

**Calibration** – A seven-point calibration was made using standards from 0.02 mg/kg to 2 mg/kg. Figure 4 shows the linear regression results of this calibration. The use of an FID greatly simplifies the detection and quantitation of sulfur compounds since it has a linear response over a large dynamic range instead of the quadratic response of some sulfur selective detectors (that is, flame photometric detector [FPD], and pulsed flame photometric detector [PFPP]).

**Sample analysis** – Two benzene samples were run using the 2-D GC system for the analysis of thiophene. The first sample was commercially purchased and described as “thiophene-free.” The second sample was industrial benzene used as a styrene feedstock. Each sample was analyzed a total of 15 times over a 5-day period using the same GC conditions and heart-cut window used for the calibration standards. Figures 5 and 6 show the chromatographic results for these samples obtained with this 2-D GC system. The precisions for RT, thiophene peak area, and quantitative results are shown in Table 3 for both samples. The high precision for the RT and quantitative results obtained with the 2-D GC system shows the stability of the Deans switch design.

**Table 3. 2-D GC Analysis Results for Two Benzene Samples**

	"Thiophene free"	Styrene feed
RT (min)	17.718	17.718
(% RSD)	(0.03)	(0.03)
Amount (mg/kg)	0.2	0.06
(% RSD)	(2.2)	(4.8)

A GC-AED system was also used to analyze thiophene in these two benzene samples. Ten runs per sample were made over a 3-day period. For the “thiophene-free” benzene, 0.2 mg/kg of thiophene (% RSD = 1.0) was measured and for the styrene feed sample, 0.05 mg/kg of thiophene (%RSD = 1.8). These results compare favorably with those obtained on the 2-D GC system (Table 3).

The standard benzene analysis described by ASTM method D4492 uses a 60-meter INNOWax column to measure overall benzene purity and key impurities such as hydrocarbons, toluene, and 1,4-dioxane [1]. Since this 2-D GC system also uses INNOWax as the primary column, this system can also be used to perform this standard benzene analysis at the same time as the thiophene determination is made.

On an INNOWax column, C<sub>8</sub> and C<sub>9</sub> hydrocarbons are known to co-elute with benzene. These hydrocarbons represent a potential interference

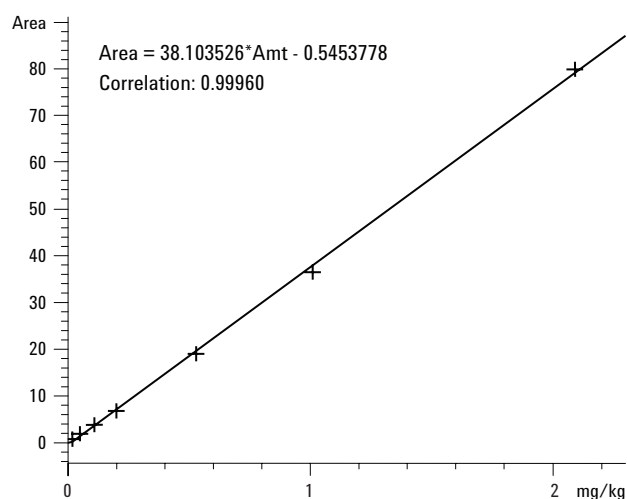

**Figure 4. Seven-point calibration using 0.02, 0.05, 0.1, 0.2, 0.5, 1, 2 mg/kg thiophene in benzene standards.**

### Thiophene-free benzene sample

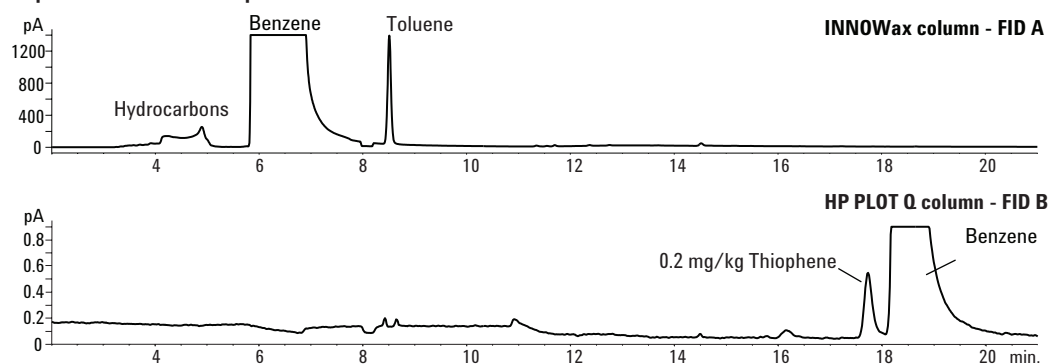

Figure 5. Analysis of thiophene for thiophene-free benzene using the 2-D GC system.

### Styrene feed benzene sample

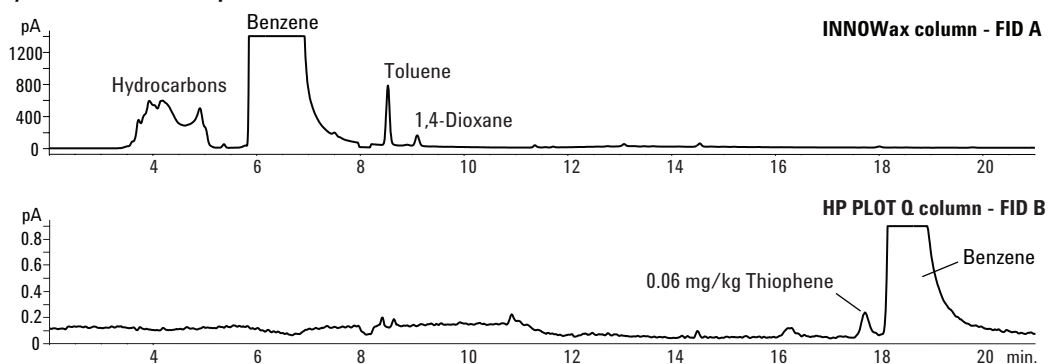
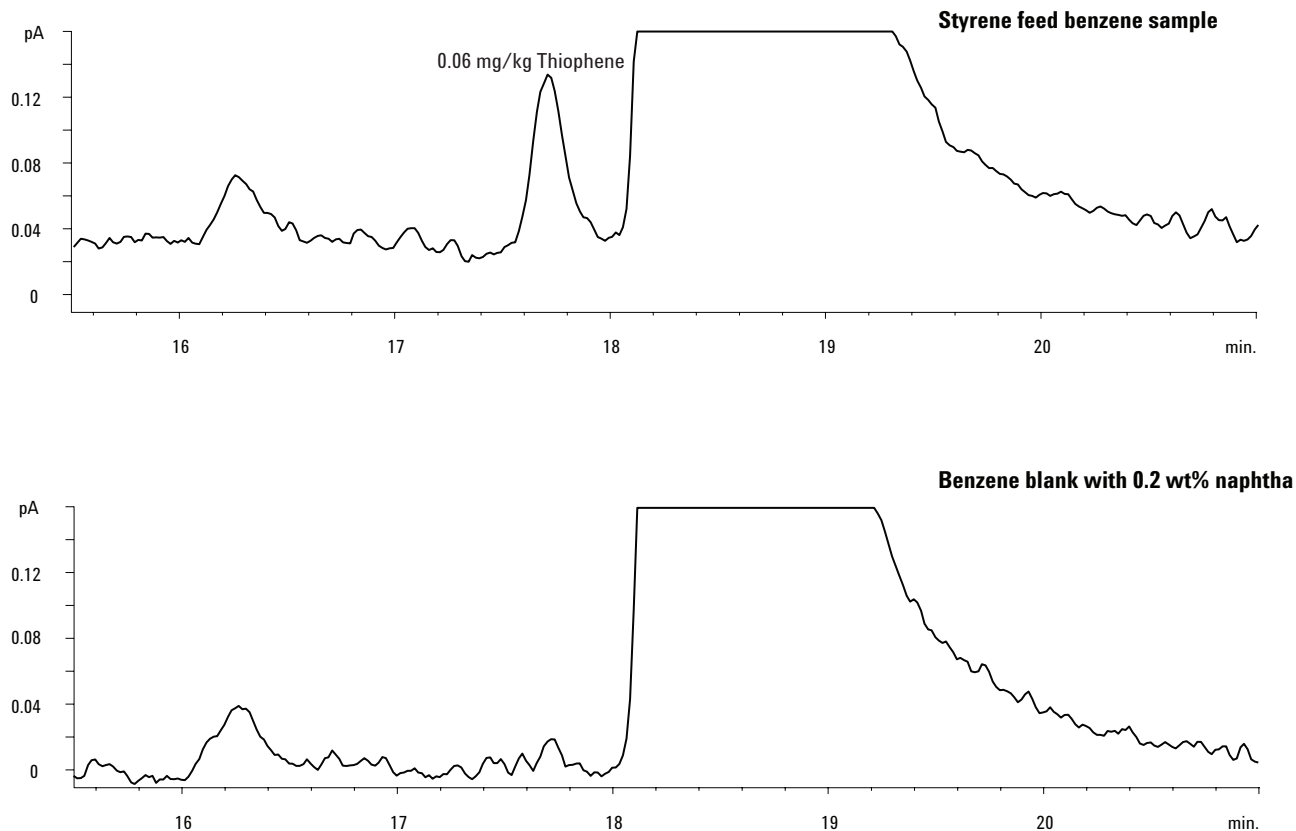

Figure 6. Analysis of thiophene for styrene feed benzene using the 2-D GC system.

with thiophene if they are in the heart-cut and cannot be resolved by the PLOT Q column. A benzene blank sample was spiked with 0.2 wt% of petroleum naphtha containing a number of C<sub>8</sub> and C<sub>9</sub> hydrocarbons. This sample was analyzed using the 2-D GC system under the same conditions as for the thiophene analysis. No hydrocarbon peaks were observed on the PLOT Q column at the RT where thiophene was expected (Figure 7). Therefore, any hydrocarbons contained in the heart cut were successfully separated from thiophene by the PLOT Q column.

Since the PLOT Q column was shown to completely separate thiophene from benzene, one

would be tempted to use this column alone without the 2-D GC. However, to achieve the desired sensitivity, a 2 to 4  $\mu$ L splitless injection is required. Since PLOT columns have very low capacities, an injection of this size would overload the column with benzene with a resultant loss of resolution. The 2-D approach described in this application note uses the INNOWax column to greatly reduce the amount of benzene that is loaded on the PLOT Q column. This assures that the thiophene can be separated and detected in a pure benzene matrix. Additionally, 2-D GC eliminated any other potential chromatographic interferences, such as hydrocarbons, so that nonselective GC detectors can be used for trace thiophene determination.



**Figure 7.** The upper chromatogram shows a the elution of thiophene on the PLOT Q column after heart-cutting. In the lower chromatogram, a benzene blank was spiked with 0.2 wt% of petroleum naphtha and analyzed by the 2-D GC system. No hydrocarbon interferences were observed to elute at the same time as the thiophene peak.

## Conclusion

The 2-D GC system described in this application note was used to measure trace (mg/kg) quantities of thiophene in pure benzene using standard flame ionization detection. The use of two columns with different selectivity completely separates the thiophene peak from the benzene and other interfering matrix compounds. This system was shown to be precise and stable over extended periods of time. The quantitative results for thiophene that can be obtained with this system are nearly identical with those obtained using more expensive and complex GC systems with sulfur selective detectors. Additionally, the system was also shown to be versatile and cost effective since it can perform both the thiophene determination and overall benzene purity analysis in one run, on one system.

## References

1. Annual Book of ASTM Standards, Vol. 06.04 "Paint - Solvents; Aromatic Hydrocarbons," ASTM, 100 Barr Harbor Drive, West Conshohocken, PA 19428 USA.
2. McCurry, J.D. and Quimby, B.D., "Two-dimensional Gas Chromatographic Analysis of Oxygenates and Aromatics in Gasoline Using a Heart-Cutting Technique," Agilent Technologies, publication 5988-6696EN [www.agilent.com/chem](http://www.agilent.com/chem)

## For More Information

For more information on our products and services, visit our web site at [www.agilent.com/chem](http://www.agilent.com/chem).

Agilent shall not be liable for errors contained herein or for incidental or consequential damages in connection with the furnishing, performance, or use of this material.

Information, descriptions, and specifications in this publication are subject to change without notice.

© Agilent Technologies, Inc. 2003

Printed in the USA  
April 24, 2003  
5988-9455EN