

A Guide to Direct and On-column Flash Vaporization Injection

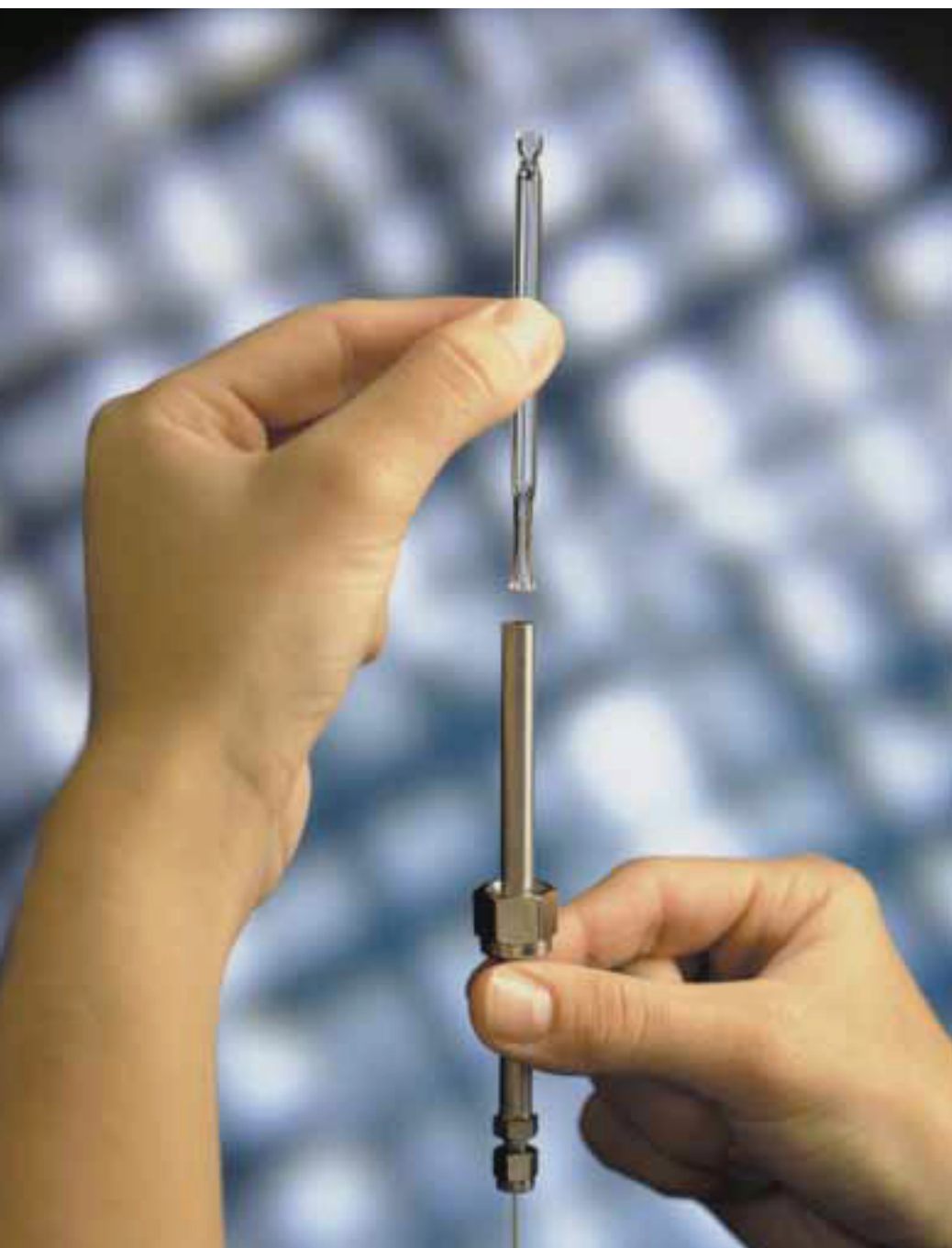

Inside:

Overviews of direct and on-column flash vaporization injection techniques

Advantages of direct injection over splitless injection

Practical guidelines to maximize analysis accuracy and reproducibility

Recommendations for converting a split/splitless injection port for direct injections

Alternatives for converting a packed column injection port for direct injections onto 0.32mm ID or 0.53mm ID capillary columns

Table of Contents

Introduction to Direct Injection	2
• What is direct flash vaporization injection?	
• What is the difference between direct and on-column flash vaporization injection?	
• What are the advantages of direct injection over splitless injection?	
Injection Port Setup for Direct Injection	5
• Types of injector liners used in direct injection systems	
• Converting a split/splitless injection port to direct injection	
Converting a packed column injector to direct injection	
Careful – don't crush the column end!	
Detector Setup for Direct Injection	6
• Use of make-up gas with a direct injection system	
Optimizing Direct Injection	7
• Direct injection requires higher carrier gas flow rates than split or splitless injection	
• Use only high quality septa when making direct injections	
• Keep injection volumes small when making direct injections	
• Compress the sample vapor cloud when making large injections	
• Electronic pressure control and direct injection	
Optimizing Direct Injection When Using Agilent 6890 EPC GCs	12
Inlet and FID Maintenance Kits for Agilent GCs	13
Injector Liners	14
for Agilent & Finnigan GCs	14
for Varian GCs	15
for Shimadzu GCs	15
for PerkinElmer GCs	16
for Thermo Finnigan GCs.....	16
Siltek™-Deactivated Inlet Liners	17
Base-Deactivated Inlet Liners	17
Restek Enhanced Split/Splitless Injection Port for Agilent 5890 GCs	18
Replacement Split/Splitless Injection Ports for Agilent GCs	19
Inlet Seals for Agilent 5890/6890/6850 Split/Splitless Injection Ports	19
Cross-Disk Inlet Seal for Agilent 5890 GCs	19
Nuts & Fittings	20
Septa	21
Ferrules	22

Introduction to Direct Injection

While splitless injection is still the most popular trace sample introduction technique, direct injection is rapidly gaining in popularity as analysts search for better ways to analyze trace-level compounds or for simpler conversions from packed to capillary systems. Compared to splitless analysis, direct injection offers higher sensitivity, reduced adsorption of active compounds, and operational simplicity. In addition, the high performance and low cost of the equipment required to perform direct injection has accelerated its acceptance as a main-stream sample introduction technique.

This guide discusses the many important aspects of direct flash vaporization injection on 0.32mm or 0.53mm ID capillary columns. Advantages and disadvantages of direct injection are outlined and compared to the performance of other injection techniques. Considerations such as modifying splitless inlets, retrofitting packed column injection ports, and the need for make-up gas are discussed. Finally, operational parameters such as flow rates and sample injection volume versus injection speed are reviewed.

What is direct flash vaporization injection?

In direct flash vaporization injection, a liquid sample is injected via a syringe into a heated injection port. The sample is rapidly vaporized in the injection port, then transferred to the column. This injection technique is very popular with packed columns but, when used with the first-developed capillary columns, the highly concentrated samples caused overloaded peaks and poor resolution. Subsequently, split systems were developed to provide on-column sample volumes and analyte quantities that were compatible with the low flow rates and limited capacities of capillary columns. Split injections produced symmetrical peaks, while allowing concentrated samples to be injected in the same manner as in packed column systems. Later, split systems were modified to include a splitless injection mode to direct the entire sample into the column for analysis of trace analytes. Direct injection parallels splitless injection at the beginning of the sample introduction process ("purge off" mode or split vent closed), but in splitless injection gas flow in the injection port is switched to the "purge on" mode after a short period of time, thereby flushing excess solvent vapor from the injection port. (See Restek's *Operating Hints for Using Split/Splitless Injectors* Lit. cat.# 59880A for more information.) Because direct injections do not include a "purge on" mode, the entire sample vapor cloud is swept into the column.

Today, direct flash vaporization injections are better understood and are recognized as offering many advantages over splitless injections for the analysis of difficult components. These advantages include less adsorption of active compounds, less discrimination against high-boiling compounds, and better sensitivity for trace components. Direct injection also can be used for concentrated samples commonly analyzed on split/splitless systems, provided the sample is first diluted with a solvent and the injection volume is kept small to prevent column overload. Superior responses for active, high-boiling, or trace compounds, combined with its simplicity and low cost have led to the resurgence of direct injection in many laboratories.

What is the difference between direct and on-column flash vaporization injection?

Both direct injection and on-column injection deliver the entire sample to the column. The difference between the two techniques is denoted by the termination point of the syringe needle during the sample injection and vaporization process (Figure 1). In an on-column injection, the tip of the needle enters the column and the liquid sample is deposited directly inside the column. In a direct injection, the tip of the needle enters a glass injection port liner and the sample is vaporized in the buffer volume of the injection port liner. Thus, in a direct injection, the sample is a vapor before it reaches the column.

Of the two, direct injection is the preferred mode of sample introduction because the injections are less problematic. On-column injections usually are made by introducing the tip of a 26-gauge needle (0.48mm OD) into the bore of a 0.53mm ID column. This tight fit leaves little space for sample expansion during the explosive vaporization process, and solvent peak tailing is a common result. On-column injections cannot be made into a 0.32mm or smaller ID column because the syringe needle is too wide to introduce into the column.

Figure 1.

Direct injection and on-column injection differ in where the syringe needle terminates during sample vaporization.

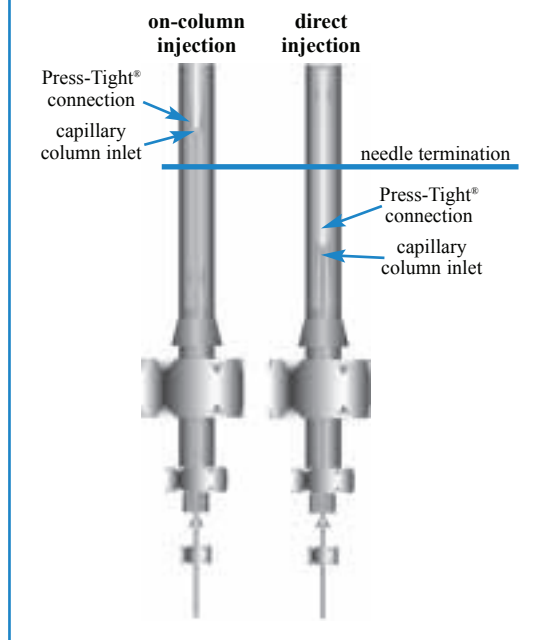

In contrast, a direct injection is made into a 2mm or 4mm ID injection port liner, and the large buffer volume of the liner ensures adequate space for sample vaporization. The vaporized sample is transferred to a 0.32mm or 0.53mm ID column. Larger sample volumes can be used with direct injections, with minimal sample backflash and solvent peak tailing.

Direct injection also reduces the need for column maintenance relative to on-column injection. In on-column injections, the tip of the syringe needle enters the column bore and there is a potential for chipping the edge of the column or damaging its inner surface. Fragments of fused silica and scratches in the stationary phase coating in the interior of the column inlet can produce adsorptive sites for active sample components, thereby requiring portions of the inlet side of the column to be removed periodical-

ly. Direct injection, however, reduces the frequency of maintenance cycles because there is less physical damage to the column inlet. On the other hand, direct injection dictates that the injection port liner be changed or cleaned during routine maintenance.

When samples are dirty or contain non-volatile residue, direct injection should be used instead of on-column injection. The injector liner will trap the non-volatile sample residue and keep it from entering the column. Maintenance is minimal—simply clean or replace the injector liner. In contrast, column maintenance as a consequence of on-column injections of dirty samples requires removing the inlet end of the column from the injection port, discarding several loops of the column, then reinstalling the column. The only potential advantage to on-column injection over direct injection is that delivery of the sample into the bore of an inert fused silica column might reduce the possibility of analyte adsorption, compared to depositing the sample in an injector liner. However, using deactivated injector liners (all Restek injector liners are fully deactivated) helps minimize the likelihood of analyte adsorption during the sample vaporization and transfer process. Because direct injection results in significantly less column maintenance and allows a larger injection volume than on-column injection, direct injection is becoming much more popular as a sample introduction technique in capillary GC.¹

¹ Most factory-installed GC injectors are designed for split or splitless injections, but these injectors can be adapted for direct injections simply by purchasing liners designed for direct injection. For information about the availability of direct injection liners for your GC model, refer to pages 14-16, or call Restek's Technical Service Group at 800-356-1688 or 814-353-1300, ext. 4.

What are the advantages of direct injection over splitless injection?

Because both direct and splitless injections attempt to deliver the entire sample vapor cloud onto the column in the narrowest band possible, both techniques are used primarily for trace-level sample analysis. Only in a direct injection system, however, does the injector liner make a positive seal with the column inlet. This leak-tight connection between the liner and the column ensures that the entire sample enters the column, thereby enhancing the overall sensitivity of the analysis. Adsorption of active species is minimized and responses are greater for higher molecular weight compounds.

Figure 2.

Splitless and direct injection liners installed in a splitless capillary injector.

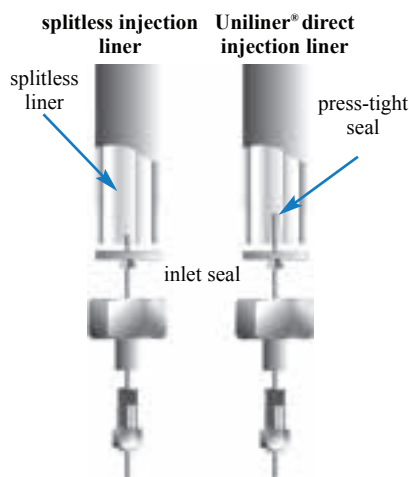

A Uniliner® direct injection liner prevents the sample from contacting metal surfaces in an injection port, so sample adsorption and catalytic decomposition are reduced and responses for high molecular weight compounds are greater.

We compared a splitless injection liner and a direct injection liner installed in a capillary GC injector (Figure 2). Notice that the splitless injection liner allows the sample vapor to contact the metal inlet seal at the base of the injection port. Sample vapor potentially can adsorb onto this metal surface, or can condense in the area below the column inlet. Either occurrence can cause low response for active or high molecular weight compounds. In contrast, because the direct injection liner makes a positive seal with the column inlet, all sample vapor is directed onto the column and cannot interact with metal injection port surfaces. Therefore, sensitivity for active and high molecular weight compounds is significantly improved.

Table I summarizes the chromatographic results obtained when a mixture containing active and high molecular weight compounds was injected into three different splitless injection liners and two different direct injection liners. The most typical injection port liner used for splitless injections is a straight liner with a 4mm internal diameter, packed with deactivated fused silica or glass wool (A). The benefit in using a straight liner packed with wool is that the wool enhances sample vaporization and thereby improves the responses for high molecular weight compounds (represented in this analysis by benzo(b)- and benzo(k)fluoranthene). However, when the relative responses obtained by using a straight liner packed with wool (A) are compared to responses from two splitless injection liners with a gooseneck restriction of the internal diameter at each end (B and C), it is apparent that the active probes (2, 4-dinitrophenol, nitrophenol, and pentachlorophenol) were completely adsorbed in the injection port when the straight liner packed with wool was used. A double gooseneck liner (B) improves the response for active compounds by confining the sample cloud within the buffer volume of the liner. This reduces sample contact with the metal support disk in the injector and, thus, reduces adsorption. A double gooseneck liner with an internal glass spiral (C) not only provides good response for active compounds, but also provides better vaporization of high boiling analytes compared to a double gooseneck liner without a glass spiral. Because a

Table I.

Responses for active and high molecular weight compounds are greater with direct injection, compared to the same injector configured for splitless injection.

Analyte	Splitless Injection			Direct Injection	
	A 4mm ID wool-packed	B Double Gooseneck	C Cyclo Double Gooseneck	D Uniliner®	E Cyclo-Uniliner®
benzoic acid	NA	0.90	1.23	1.06	1.21
C14	1.00	1.00	1.00	1.00	1.00
2,4-dinitrophenol	NA	0.33	0.46	0.68	0.58
nitrophenol	NA	0.73	0.93	1.24	1.17
nitroaniline	1.03	0.78	0.93	1.20	1.20
pentachlorophenol	NA	0.45	0.55	0.70	0.66
carbazole	2.01	1.43	1.69	2.17	2.06
C20	1.13	0.89	0.98	1.16	1.09
C21	1.08	0.81	0.92	1.10	1.04
C22	1.13	0.81	0.94	1.15	1.09
benzo(b)fluoranthene	2.18	1.18	1.90	2.22	2.47
benzo(k)fluoranthene	2.09	1.15	1.84	2.27	2.36

NA – Peak not quantifiable; data not available.

The data illustrate that direct injections improve responses in general, but especially improve responses for active high molecular weight compounds compared to splitless injections. A double gooseneck splitless injection liner provides better responses than an open, wool-packed splitless injection liner, but it is not until a positive seal is made between the liner and the capillary column (D and E) that significant improvements are observed.

Analysts who use direct injections instead of splitless injections can expect better overall sensitivity and greater response factors for both active and high molecular weight compounds.

30m, 0.32mm ID, 0.25µm XTI-5 column (cat.# 12224), splitless or direct injection of 1µL XTI Mix, concentration = 29ng/µL.

Oven temp.: 100°C to 285°C @ 6°C/min., then to 360°C @ 30°C/min. (hold 5 min.)
 Inj./Det. temp.: 250°C/360°C
 Carrier gas: hydrogen
 Linear velocity: 40cm/sec. set @ 100°C
 FID sensitivity: 8 x 10⁻¹¹ AFS
 Splitless hold time: 0.75 min.

- A: splitless injection, 4mm ID injector liner packed with glass wool (cat.# 20781)
- B: splitless injection, double gooseneck injector liner (cat.# 20784)
- C: splitless injection, cyclo double gooseneck injector liner (cat.# 20895)
- D: direct injection, Uniliner® injector liner (cat.# 20335)
- E: direct injection, Cyclo-Uniliner® injector liner (cat.# 20337)

All analyses conducted with an Agilent 5890 II GC equipped with an autosampler and a dirty inlet seal.

Uniliner® direct injection liner (D or E) connects directly to the column inlet, responses for both active and high molecular weight compounds are greater than for any of the splitless injection liners. There is little difference between responses when using a Uniliner® direct injection liner (D) or a Cyclo-Uniliner® liner (E). Both liners direct all of the sample onto the column while minimizing contact between the vaporized sample and other injection port surfaces. However, a Cyclo-Uniliner® liner or a Uniliner® containing deactivated wool always should be used when injecting dirty samples.

Injection Port Setup for Direct Injection

Types of injector liners used in direct injection systems

Restek carries three styles of direct injection liners (Figure 3). Of these, the buffer volume chamber in standard Uniliner® injection port liners (A) will accommodate the largest sample vapor cloud. Because of the open design, samples should be relatively clean, otherwise contaminants could be delivered into the column inlet. For extremely dirty samples, open-top Uniliner® injection port liners (B) can be packed with deactivated fused silica wool to trap dirt and non-volatile sample residue. Contaminated wool can be replaced easily and the liner cleaned with solvent and a nylon brush. The glass spiral in a Cyclo-Uniliner® injection port liner (C) provides a surface for vaporizing high and low molecular weight compounds. Non-volatile sample residue is trapped on the first turn of the spiral, reducing subsequent interaction between that contamination and the rest of the sample. In comparison with liners packed with wool, a Cyclo-Uniliner® injection port liner will accept up to five times as many injections of dirty samples before calibration curves degrade. Each of these Uniliner® designs incorporates a gradual, press-tight taper in the base of the liner, which forms a positive seal with the column end and prevents sample components from interacting with heated metal surfaces in the injection port. The seal of the column into the press-tight taper of the injection port sleeve is the key to obtaining maximum responses for all analytes and minimizing solvent peak tailing.

Converting a split/splitless injection port to direct injection

The most common problems associated with splitless injections are caused by the absence of a direct, physical connection between the injection port liner and the column inlet (Figure 2). Sample vapor that accumulates in the space around the inlet of the column is exposed to hot, catalytic metal surfaces of the injection port. Excess sample vapor and less volatile high molecular weight compounds also can be swept out the split vent during the purge on mode. By making a leak-free connection between the injection port liner and the inlet end of the column via the press-tight taper, contact between the vaporized sample and the metal surfaces of the injection port is eliminated and the loss of sample out of the split vent is prevented.

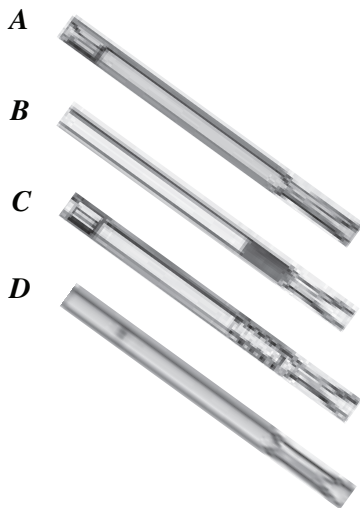

Figure 3.

Choose a direct injection liner based on sample characteristics. The buffer volume chamber accommodates the sample vapor cloud and prevents sample components from contacting metal injection port surfaces.

A) Standard Uniliner® Injector Liner

Accommodates large, relatively clean samples.

B) Open-Top Uniliner® Injector Liner with Wool

Ideal for extremely dirty samples.

C) Cyclo Uniliner® Injector Liner

Excellent for high and low molecular weight compounds; accepts many injections of dirty samples.

D) Drilled Uniliner® Inlet Liner

The drilled hole in a Uniliner® injection port liner makes direct injection possible with EPC systems by equalizing pressure in the injection port.

Figure 4.

Vu-Tight® injection liner—in a 1/4-inch packed column injection port—allows visual confirmation of the liner-column connection.

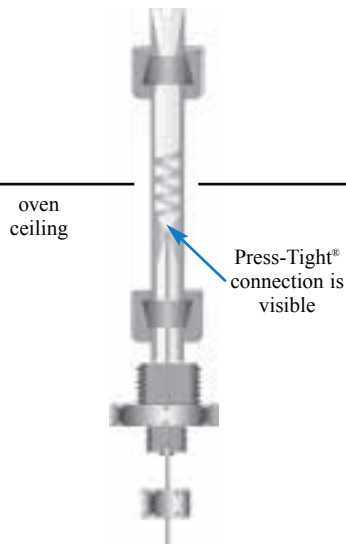
**Figure 5.**

Good vs. poor column installation in a Vu-Tight® liner.

good installation

A brown ring indicates a good press-tight seal.



poor installation

Failure to seat the ferrule before connecting the column leads to a crushed column end.



Always seat the ferrule before connecting the column

A Uniliner® direct injection port liner can be directly substituted for a split or splitless injection port liner, quickly and easily adapting the injection port for use in the direct injection mode. A Uniliner® direct injection port liner is installed in the same manner as a splitless liner, but it must be operated continuously in the purge off mode. Uniliner® injection port liners are available for a wide variety of instruments, and are manufactured to the exact external dimensions specified for the split/splitless liners they are designed to replace.

Converting a packed column injector to direct injection

A 1/4-inch packed column injection port configured for on-column injections easily can be converted for direct injections onto 0.32mm or 0.53mm ID capillary columns by using a specially designed glass liner that forms a seal with the column inlet. Conversion of a packed column inlet is accomplished in less than 15 minutes. *Note that only packed column injectors with an on-column configuration can be retrofitted with these liners.*

We offer two injection port conversion kits in our chromatography products catalog: 1) A glass Vu-Tight® injection port liner fits directly into a 1/4-inch packed column injection port and allows visual confirmation of the connection between the injection port liner and the inlet of the capillary column (Figure 4). 2) A 1/4-inch Uniliner® sleeve adapter is fitted into a 1/4-inch injection port. A 5mm Uniliner® injection port liner can be inserted into the adapter in either direction to allow direct or on-column injections (Figure 1 on page 3). Both conversion kits incorporate the press-tight connection between the injection port liner and the inlet of the column. The combination of a sample expansion chamber and a leak-free connection between the injection port liner and the column delivers superior chromatographic performance. Direct connection of the liner to the column inlet also minimizes dead volume, reducing solvent peak tailing and sharpening peaks for early-eluting components.

Either the Vu-Tight® injection port liner or the Uniliner® sleeve adapter with liner will fit Agilent, Varian, or other common GCs with 1/4-inch packed column injection ports. Either 0.32mm or 0.53mm ID fused silica columns can be used with either conversion kit, as long as the tubing OD is 0.4mm or greater. A special high-temperature deactivating procedure creates an inert surface in the liners, so they will not absorb or react with active compounds such as pesticides, phenols, acids, or basic compounds. Liners that incorporate a glass spiral are available for either conversion system and should be used for the injection of dirty samples.

Careful – don't crush the column end!

Frequently, analysts setting up a direct injection system for the first time will crush the column end into the Press-Tight® taper. When a column is installed with a new graphite ferrule, excessive movement of the column into the Press-Tight® taper will crush the end of the column and force fused silica particles into the column bore. In order to limit the movement of the column and prevent damage, the ferrule must be seated in the fitting before the column is installed all the way into the Press-Tight® taper. To properly install a column in a direct injection liner, withdraw the column end several millimeters away from the Press-Tight® taper and tighten the ferrule into the fitting until the column end no longer moves forward into the liner. The ferrule is now seated and conforms to the interior dimensions of the fitting. Next, loosen the ferrule and push the column into the liner until it seals against the Press-Tight® taper. A dark brown ring at the tip of the column where it contacts the inside surface of the injection port liner indicates a good seal. Now, when the ferrule is retightened, the column end will not be crushed against the liner. Figure 5 shows a column properly installed in a Vu-Tight® liner, and a column that has been crushed because the ferrule was not seated first.

Detector Setup for Direct Injection

Use of make-up gas with a direct injection system

Most flame ionization detectors (FIDs) do not function optimally unless they are supplied with approximately a 1:1 ratio of carrier gas and hydrogen fuel. Because most columns used in direct injection systems operate at a carrier gas flow of between 5 and 10cc/min., make-up gas must be added to augment the low carrier gas flow.² Make-up gas improves peak shape, and may reduce detector noise and improve linearity. Similarly, electron capture detectors (ECDs) require up to 100mL of make-up gas to improve sensitivity and linearity.

PerkinElmer FIDs do not use make-up gas.

To minimize adsorption and prevent peak tailing, always make sure that the outlet end of the column is correctly positioned inside the FID jet tip (Figure 6), close to the jet orifice or close to the entrance of the ECD detector cell. Read and carefully follow the instrument manufacturer's specifications. In an instrument designed for packed column GC, the FID jets should be replaced with jets designed to function with capillary columns or peaks might tail.

Optimizing Direct Injection

When using direct injection as the sample introduction technique, the sample is injected in a liquid form via a syringe. The sample is vaporized in the heated injection port and the carrier gas transfers the vapor to the head of the column. The two most common problems associated with hot vaporization injections in the direct injection mode are broad, tailing peaks and sample backflash. Choosing the proper carrier gas flow rate and sample size will allow you to achieve optimum chromatographic performance.

In the direct injection mode, all of the sample and carrier gas is directed into the head of the column. In order to produce the narrowest sample bandwidth possible, the vaporized sample must be transferred from the injection port liner to the head of the column as quickly as possible. If the sample is not transferred quickly, a broad, tailing solvent front will be produced and resolution of early-eluting compounds will be compromised.

Direct injection requires higher carrier gas flow rates than split or splitless injection

Direct injection systems perform best when high column flow rates are used. When a 30m, 0.32mm ID capillary column is operated with helium at a linear velocity of 20cm/sec., a column flow rate of approximately 1cc/min. is obtained. When 1 μ L of a sample diluted in methylene chloride is injected into a heated injection port, the sample expands to more than 400 μ L of gas volume. At a column flow rate of 1cc/min., it takes more than 24 seconds to transfer the vaporized sample from the buffer volume in the direct injection liner to the head of the column. If the carrier gas flow is increased to a linear velocity of 80cm/sec. (approximately 7cc/min.), the 400 μ L of methylene chloride vapor will be transferred from the liner to the head of the column in less than four seconds. This rapid transfer of the sample cloud ensures narrow initial sample bandwidths.

Significant differences in chromatography arising from the difference in sample delivery time are evident in Figure 7. Figure 7a shows a mixture of phenols injected using an optimum carrier gas linear velocity (hydrogen, 40 cm/sec.). Notice the tailing of the solvent peak, coelution of 2-nitrophenol and 2,4-dimethylphenol (peaks 3 and 4), and minimal baseline resolution of 2,4-dinitrophenol and 4-nitrophenol (peaks 8 and 9). Figure 7b shows the same sample delivered and separated using a faster carrier gas linear velocity (80 cm/sec.). The solvent peak is significantly sharper, and 2-nitrophenol / 2,4-dimethylphenol and 2,4-dinitrophenol / 4-nitrophenol are fully resolved. For Figure 7c, the carrier gas linear velocity was increased to 120cm/sec. (approximately 120 cm/sec.). The solvent peak shape is further improved and the two pairs of phenols are well resolved. Further increases in flow rate are counterproductive, however, because they decrease the efficiency of the column and reduce resolution of the early-eluting compounds.

³Restek offers high performance make-up gas kits to fit most GCs. For details, see our current chromatography products catalog.

Figure 6.

Restek designed the flared jet tip (arrows) to make capillary column insertion easy.

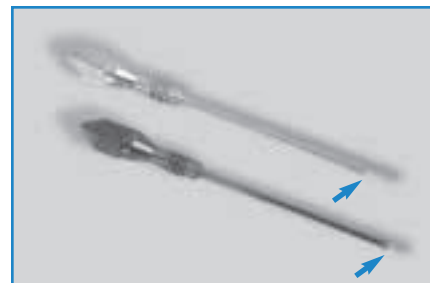

Replacement FID Jets

- Standard Version: Engineered with a fluted tip to guide the capillary column into the jet.
- High-Performance Version: Identical to the standard version, except that it has been Silcosteel®-treated. Extremely inert, use with active compounds.

Capillary Adaptable FID Replacement Jet for Agilent 5890/6890/6850 GCs (0.011-inch ID tip) (Similar to Agilent part # 19244-80560.)

Description	qty.	cat.#	qty.	cat.#
Standard	ea.	20670	3-pk.	20671
High-Performance Silcosteel®	ea.	20672	3-pk.	20673

Capillary Dedicated Replacement FID Jets for Agilent 6890/6850 GCs (Similar to Agilent part # G1531-80560.)

Description	qty.	cat.#	qty.	cat.#
Standard	ea.	21621	3-pk.	21682
High-Performance Silcosteel®	ea.	21620	3-pk.	21683

Capillary FID Replacement Jets for Agilent 5880 GCs (Similar to Agilent part # 19301-80500.)

Description	qty.	cat.#
Standard	ea.	21637
High-Performance Silcosteel®	ea.	21638

Use only high-quality septa when making direct injections

Because all of the carrier gas flow is directed into the inlet of the column, high-quality, low-bleed septa must be used with direct injection systems that are not equipped with a septum purge. Volatile compounds that are released from septa material after heating in an injection port can make their way onto the column if not vented off using a septum purge. These compounds will focus at the head of the column when using low flow and low temperature conditions and will be displayed as ghost peaks in the chromatogram, or as increased background or column bleed.

Figure 7.

When used with direct injections, 0.32mm or 0.53mm ID columns perform better at elevated flow rates.

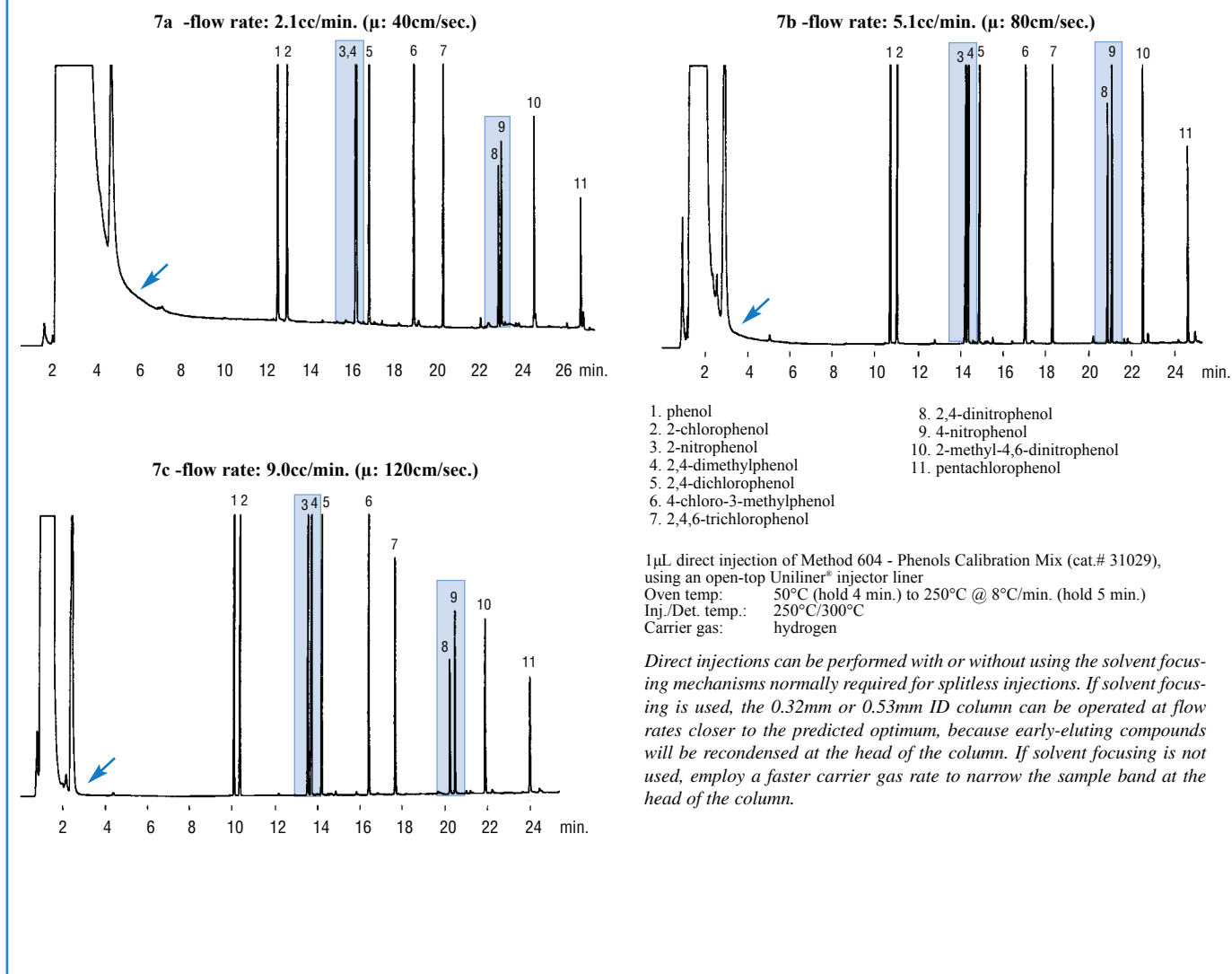

Figure 8 shows a pesticide analysis performed on a direct injection system fitted with a low-quality septum, then with a high-quality Thermolite® septum. Notice that outgassed products from the low-quality septum interfere with peaks 3, 4, and 5, and with peaks 18 and 19. Use of a packed purged injector or a splitless injector (either of which incorporates a septum purge system) greatly diminishes this problem. To ensure that your analyses are free of septum contaminants, however, it is wise to always use high-quality septa, even with a septum purge system. For more information on the advantages of using high-quality septa, request our *Guide to Minimizing Septa Problems* (Lit. cat. # 59886).

Keep injection volumes small when making direct injections

In general, analysts should strive to keep sample injection volumes as small as possible when using direct injections, ideally less than 1µL. Sample sizes greater than 1µL increase the probability of backflash, in which a portion of the vaporized sample can spill out of the top of the injection port liner. Sample backflash can lead to tailing peaks, split peaks, and poor resolution. If the sample volume must exceed 1-2µL, higher injection port pressures or slower rates of injection can minimize backflash.

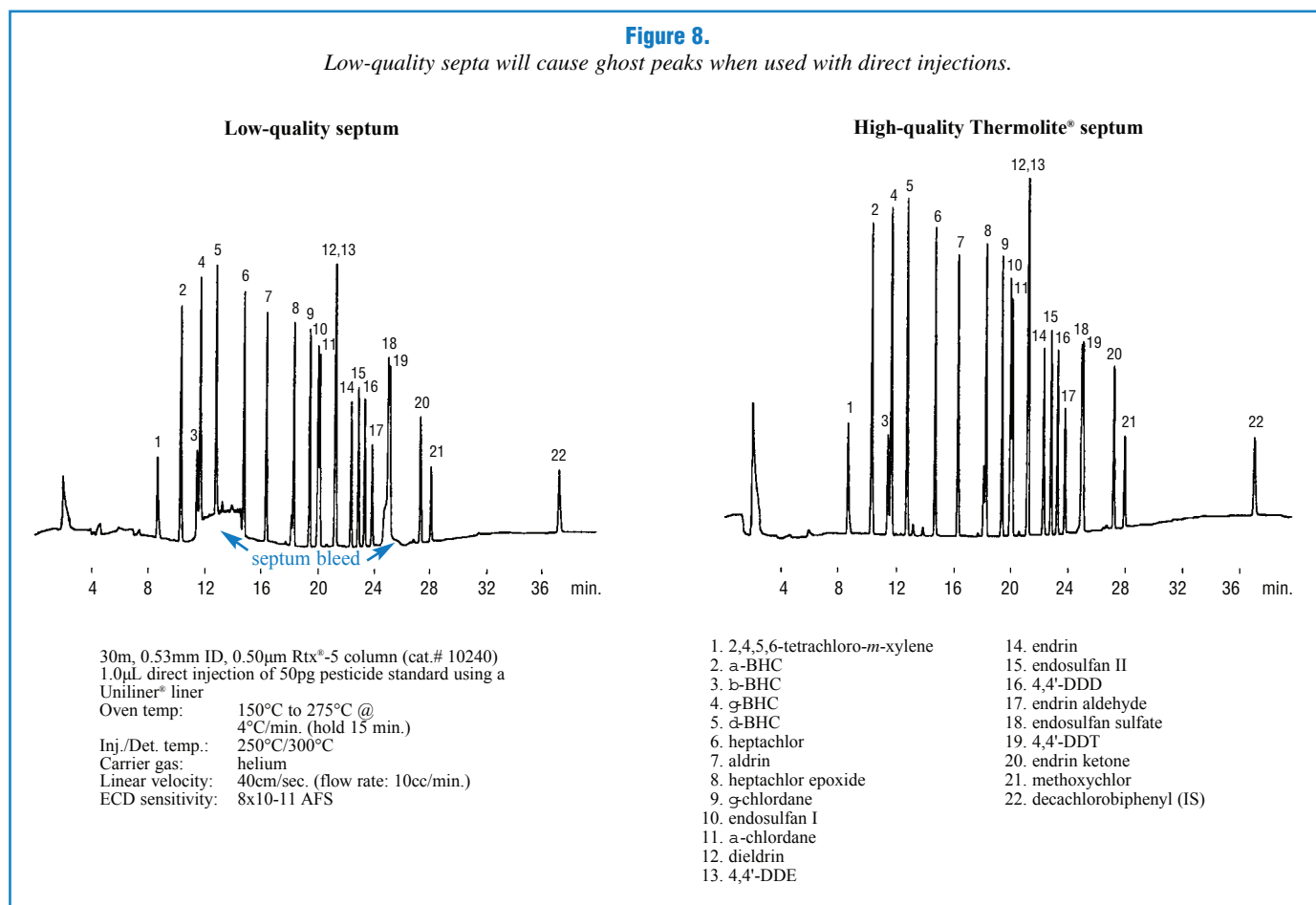

Table II shows typical expansion volumes for common sample solvents at a pressure of 10psig. These expansion volumes can be compared to the injector liner volumes in Table III to determine whether a specific combination of solvent, sample volume, and liner ID is compatible at this pressure. For example, 1 μ L of liquid methylene chloride will expand to more than 400 μ L of vapor in a heated injection port, and 2 μ L of liquid methylene chloride will expand to more than 800 μ L of vapor. A 4mm ID Uniliner[®] direct injection liner can accommodate as much as 900 μ L of vapor before the vapor will backflash out of the injector liner and cause gross solvent tailing. The liner can accept only half this volume of solvent vapor, however, because it already contains carrier gas. Thus, the 400 μ L of vapor produced by injecting 1 μ L of methylene chloride can be accommodated by a 4mm ID Uniliner[®] liner, but the 800 μ L of vapor produced by 2 μ L of methylene chloride cannot be accommodated. Solvents with a larger expansion volume than methylene chloride also will exhibit backflash. For example, 1 μ L of a water-based sample would expand to more than 1400 μ L of vapor and would exceed the buffer volume in any of the direct injection liners.

Compress the sample vapor cloud when making large injections

Table IV further illustrates the importance of minimizing sample volume to avoid backflash. Values in this table show that when a 2 μ L injection of methylene chloride is made in combination with a typical column flow rate of 10cc/min., it would take approximately 1.7 seconds for the entire vaporized sample to be carried from the injection port liner and into a 0.53mm ID column. If a 5 μ L sample is used instead of a 2 μ L sample, it would take almost nine seconds for the entire sample to enter the column.

In order accommodate the size of the vaporized sample, a slower rate of injection could be used to allow the carrier gas flow to transfer the sample onto the column as the vapor cloud is formed. Keep in mind that slow rates of injection cannot be reproduced consistently when performing manual injections.

A better alternative for making injections larger than 1–2 μ L is to use higher carrier gas pressures in the injection port to compress the vaporized sample cloud. Table V shows how solvent density, solvent molecular weight, and pressure affect sample vapor cloud volume. Note that pressure (“P”) is in the denominator of the ideal gas law. This indicates that an increase in column head pressure will reduce the volume of the sample vapor cloud. Thus, by increasing the injection port pressure from a typical 10psig to a pressure of 15psig or more, the size of the sample vapor cloud can be reduced, allowing rapid injections of large volume samples to be made without resulting solvent peak tailing or backflash.

Table II.

Typical expansion volumes for sample solvents.

Injection Volume (liquid) (μ L)	Expansion Volume (vaporized, μ L)*				
	water	carbon disulfide	methylene chloride	hexane	isooctane
0.1	142	42	40	20	16
0.5	710	212	200	980	78
1.0	1420	423	401	195	155
2.0	2840	846	802	390	310
3.0	4260	1270	1200	585	465
4.0	5680	1690	1600	780	620
5.0	7100	2120	2000	975	775

*Expansion volumes based on a 250°C injection port temperature and a 10psig head pressure.

Table III.

Internal volumes of injector liners.†

Liner ID (mm)	Internal Volume (μ L)	
	Theoretical*	Effective**
0.53	16	
1.0	59	30
2.0	236	118
3.0	530	265
4.0	942	471

*Total internal volume for a typical 75mm-long liner.

**Liner volume available to accommodate an injection (carrier gas present in liner).

†From Grob, *Split and Splitless Injection*, 3rd ed.

Electronic pressure control and direct injection

Some GCs offer electronic pressure control (EPC), which can be used to momentarily pulse the pressure in the injection port, briefly causing an increase in carrier gas velocity during the initial injection period. Notice the reduction in solvent tailing when a 4 μ L sample of a hydrocarbon mix in methylene chloride was analyzed using EPC (Figure 9). A rapid injection was made using an Agilent 7673 autosampler into an injection port capable of EPC. The injection port pressure was increased from 8psig to 23psig just prior to the injection and was held at 23psig for 10 seconds after the injection was made. The solvent peak shape, and separation of early-eluting compounds from the solvent, are greatly improved by EPC.

Table IV.

Injection speed must be based on volume of solvent and column flow rate.

$$\text{Injection Rate} = \frac{[\text{solvent/sample expansion volume (cc)} - \text{injector liner buffer volume (cc)}]}{\text{column flow rate (cc/min.)}}$$

Injection Volume (liquid)	Expansion Volume (vaporized)	Flow rate: Injection:	Injection Time (sec.) for 0.53mm ID Columns							
			5cc/min.		10cc/min.		20cc/min.		30cc/min.	
			DI	OC	DI	OC	DI	OC	DI	OC
0.1 μ L	38 μ L		0.5	0.5	0.5	.23	0.5	.11	0.5	.08
0.5 μ L	194 μ L		0.5	2.3	0.5	1.2	0.5	.58	0.5	.39
1.0 μ L	388 μ L		1.3	4.7	0.67	2.3	0.5	1.16	0.5	.78
2.0 μ L	779 μ L		3.3	9.3	1.7	4.7	0.84	2.3	0.6	1.6
5.0 μ L	1952 μ L		17.4	23.4	8.7	11.7	4.4	5.9	2.9	3.9

DI = direct injection

OC = on-column injection

Table V.

The ideal gas law indicates that an increase in pressure greatly reduces sample expansion volume.

Solvent	Density (g/mL)	Molecular Weight	Expansion Volume (μ L)* at various column headpressures		
			5psig	10psig	15psig
heptane	0.68	100	219	174	145
hexane	0.66	86	245	196	163
pentane	0.63	72	280	224	186
toluene	0.87	92	303	242	201
ethyl acetate	0.90	88	328	261	217
chloroform	1.49	119	400	319	266
methylene chloride	1.33	85	500	399	332
methanol	0.79	32	792	629	525
water	1.00	18	1776	1418	1179

*Expansion volumes determined using a 1.0 μ L injection volume, a 250 $^{\circ}$ C injection port temperature, and a headpressure of 5, 10, or 15psig (common operating pressures for 30m columns having IDs of 0.53, 0.32, or 0.25mm, respectively). For 2 μ L injections, double the volumes.

Use these formulas to calculate values not listed in Table IV or V:

Solvent/sample expansion volume (v) = nRT / P

n = number of moles of solvent and sample.

[volume (mL) x density (g/mL)] / mol wt (g/mole)

R = gas law constant

82.06cc atm/mole $^{\circ}$ K

T = absolute temperature of injector ($^{\circ}$ K)

($^{\circ}$ K = $^{\circ}$ C + 273)

P = absolute column headpressure (atm) + 1 atm

Injector liner volume** = $\pi r^2 L$

π = 3.14

r = liner internal radius (cm)

L = liner length (cm)

**Also use this formula to determine capillary column internal volume.

HOTtechtip

If large samples must be used for direct injection, an injection port system that incorporates a septum purge line is preferred over one without a septum purge. A septum purge will sweep away any excess solvent or sample vapor that flashes out of the top of the injection port liner. Problems associated with backflash, such as peak tailing and ghost peaks, will be minimized. However, low molecular weight or low-boiling point sample components also can be swept away in the septum purge if they experience backflash problems similar to the sample solvent. This can lead to irreproducible peak areas for early-eluting compounds, and poor quantitative accuracy.

Figure 10.

Uniliner® injector liner for Agilent 6890 GCs (cat.# 21054).

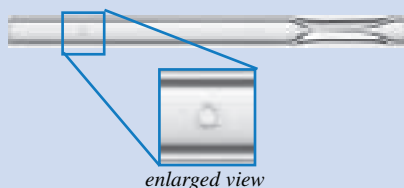

Optimizing Direct Injection When Using Agilent 6890 EPC GCs

The pneumatics in an Agilent 6890 EPC GC are not the same as in previous models of Agilent GCs. The EPC design includes one pressure sensor upstream of the injection port and a second pressure sensor downstream of the injection port, at the split vent. Because a traditional Uniliner® direct injection liner seals to the analytical column, there is no downstream flow to the split vent and there will be a difference in the pressure that is measured between the two sensors when setting up for direct injection. The upstream sensor will over-compensate for the difference and a high-pressure malfunction will result.

To prevent this problem, we have designed a Uniliner® liner with a unique geometry (Figure 10) that allows you to make direct injections using your Agilent 6890 EPC GC. A small hole in the upper part of the Uniliner® liner allows a portion of the carrier gas to escape from the liner and equalize the pressure at the second sensor, thereby eliminating pressure malfunctions. The design of the Uniliner® liner for Agilent 6890 GCs requires no software or hardware modifications, or flow adjustments. For optimum performance, keep the purge on and use a very low split flow (3 to 5mL/min. or less).

Figure 9.

4µL samples can be rapidly injected via an autosampler if EPC is used to compress the sample vapor cloud—note the improved solvent peak shape.

Direct injection of 4µL hydrocarbons (EPA/Wisconsin DRO Mix, cat.# 31064) using an autosampler.

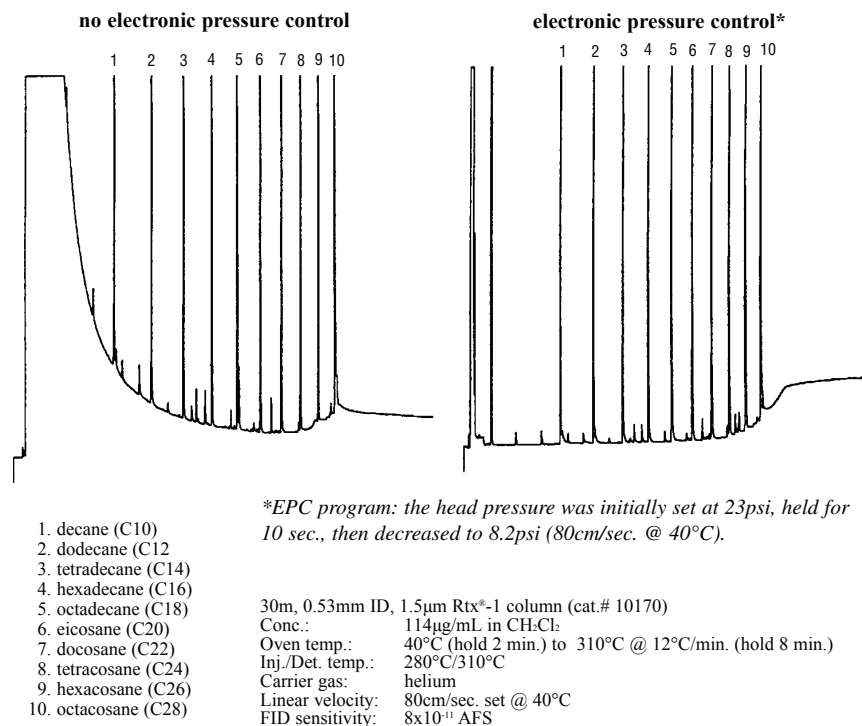

Summary

Direct injection offers higher sensitivity, less potential for adsorption of active compounds, and greater simplicity, relative to splitless injection. Less adsorption of sample components, in turn, reduces the need for column maintenance. Excellent performance and low cost of the equipment needed also are strong arguments for adopting this technique.

Products for Direct Injection Analyses

Inlet and FID Maintenance Kits for Agilent GCs

- Include the most common types of consumable supplies.
- All parts meet or exceed instrument manufacturer's specifications.
- Include parts list that makes reordering easy.

The Inlet Maintenance Kit includes these tools and many others.



Dislodge ferrules or remove silica deposits with the **Jet Reamer/Ferrule Remover**.



The **Capillary Installation Gauge** makes seating the ferrule and installing the column consistent and easy.



The **Inlet Liner Removal Tool** safely removes an inlet liner from a hot injection port without cracking the liner—and you won't burn your fingers!



Inlet kits include:

- Viton® o-rings.
- Capillary nuts.
- Inlet seals.
- Reducing nut.
- Scoring wafer.
- 11 mm Thermolite® septa.
- 4.0mm single gooseneck liner.
- 0.4, 0.5, and 0.8mm ID graphite ferrules.
- 4.0mm split liner with wool.
- Capillary column caps.
- 1/4- to 5/16-inch wrench.
- Septum puller.
- Installation gauge.
- Wire cleaning brush.
- Jet reamers/ferrule removers.
- Inlet liner removal tool.

The FID Maintenance Kit includes these tools and many others.



FID maintenance made easy with tools and replacement components specifically matched to your instrument.



The **FID Ignitor** meets original equipment specifications.



The **High-Performance Silcosteel® FID Jet** will stay clean longer—even when exposed to highly active compounds.









FID kits include:



- 1/4-inch, 0.4, 0.5, and 0.8mm ID graphite ferrules.
- FID/NPD capillary adaptor.
- Capillary nuts.
- Jet reamers/ferrule removers.
- 1/4-inch nut.
- Scoring wafer.
- Ignitor for either Agilent 5890 or 6890/6850 GCs.
- Capillary column caps.
- FID flow measuring adaptor.
- 1/4- to 5/16-inch wrench.
- Installation gauge.
- Wire cleaning brush.
- High-performance Silcosteel® FID jet for either Agilent 5890 or 6890/6850 GCs.
- 1/4-inch nut driver for jet removal.

Description	qty.	cat.#
Inlet Maintenance Kit for Agilent 5890/6890/6850 GCs	kit	21069
FID Maintenance Kit for Agilent 5890 GCs	kit	21070
FID Maintenance Kit for Agilent 6890/6850 GCs	kit	21071



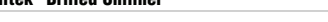

Direct Injection Liners for Agilent & Finnigan GCs (for 0.32/0.53mm ID columns)

Description	Benefits/Uses:	ID**/OD & Length (mm)	cat.# ea.	cat.# 5-pk.
 Siltek™ 1mm Uniliner®***	trace, active samples, samples <1µL	1.0 ID 6.3 OD x 78.5	21052-214.1	21053-214.5
 Uniliner®***	trace, active samples, high recovery & linearity	4.0 ID 6.3 OD x 78.5	20335	20336
 Siltek™ Uniliner®***	trace, active samples, high recovery & linearity	4.0 ID 6.3 OD x 78.5	20335-214.1	20336-214.5
 Cyclo-Uniliner®***	trace, dirty, high MW active samples, high recovery & linearity	4.0 ID 6.3 OD x 78.5	20337	20338
 Siltek™ Cyclo-Uniliner®***	trace, dirty, high MW active samples, high recovery & linearity	4.0 ID 6.3 OD x 78.5	20337-214.1	20338-214.5
 Open-top Uniliner® with Wool***	trace, dirty, active samples, high recovery & linearity	4.0 ID 6.3 OD x 78.5	20843	20844

Direct Injection Liners for use with EPC Systems (for 0.25/0.32/0.53mm ID columns)

Description	Benefits/Uses:	ID**/OD & Length (mm)	cat.# ea.	cat.# 5-pk.
 Drilled Uniliner®	allows direct injection when using an EPC-equipped GC	4.0 ID 6.3 OD x 78.5	21054	21055
 Siltek™ Drilled Uniliner®	allows direct injection when using an EPC-equipped GC	4.0 ID 6.3 OD x 78.5	21054-214.1	21055-214.5
 Siltek™ 1mm Drilled Uniliner®	allows direct injection when using an EPC-equipped GC	1.0 ID 6.3 OD x 78.5	21390-214.1	21391-214.5

CIS4 and PTV Liners for Agilent GCs

Description	Benefits/Uses:	ID**/OD & Length (mm)	Similar to Agilent part#	cat.# 10-pk.
 Straight Glass Inlet Liner	general use	2.0 ID 3.0 OD x 71	5181-2036	21157
 Baffled Glass Inlet Liner	active compounds, drugs, pesticides	1.5 ID 3.0 OD x 71	5183-2037	21704
 Siltek™ Baffled Glass Inlet Liner	active compounds, drugs, pesticides	1.5 ID 3.0 OD x 71	5183-2037	21704-214.10
 Glass Inlet Liner with Wool*	large volume injections	2.0 ID 3.0 OD x 71	5183-2039	21156

*This liner is prepacked with fused silica wool. To order glass wool instead, add the suffix "-202" to the liner catalog number.

** Nominal ID at syringe needle expulsion point.

*** These Uniliner® liners are for split/splitless injection ports.

order
**prepacked
liners**



Prepacked Liners

Order liners packed with fused silica wool, fused silica beads, glass wool, or CarboFrit™ inserts by adding the appropriate suffix to the inlet liner catalog number.





qty.	Prepacked Inlet Liners Suffix Numbers			
	FS Wool	FS Beads	Glass Wool	CarboFrit™
ea.	-200.1	-201.1	-202.1	-209.1
5-pk.	-200.5	-201.5	-202.5	-209.5
25-pk.	-200.25	-201.25	-202.25	-209.25

†CarboFrit™ inserts require a neck greater than 2mm.





Direct Injection Liners for Varian GCs (for 0.32/0.53mm ID columns)

Description	Benefits/Uses:	ID**/OD & Length (mm)	Similar to Varian part #	ea.	cat.# 5-pk.	25-pk.
 Uniliner®	trace, active samples, high recovery & linearity	4.0 ID 6.3 OD x 72	—	20345	20346	—
 Cyclo-Uniliner®	trace, dirty, high MW, active samples, high linearity	4.0 ID 6.3 OD x 72	—	20347	20348	—
 Open-top Uniliner® with Wool*	trace, dirty, active samples, high recovery & linearity	4.0 ID 6.3 OD x 72	—	20845	20846	—

SPI Liners for Varian GCs (for 0.32/0.53mm ID columns)

Description	Benefits/Uses:	ID**/OD & Length (mm)	Similar to Varian part #	ea.	cat.# 5-pk.	25-pk.
 0.5mm SPI	high linearity for 0.25 & 0.32mm ID columns	0.53 ID 4.6 OD x 54	01-900109-06	20775	20776	20777
 Siltek™ 0.5mm SPI	high linearity for 0.25 & 0.32mm ID columns	0.53 ID 4.6 OD x 54	01-900109-06	20775-214.1	20776-214.5	20777-214.25
 0.8mm SPI	high linearity for 0.53mm ID columns	0.80 ID 4.6 OD x 54	01-900109-07	20778	20779	20780
 SPI with Buffer	dirty samples >1µL, for 0.25, 0.32 & 0.53mm ID columns	2.4 ID 4.6 OD x 54	01-900109-08	20850	20851	20852

Direct Injection Liners for Shimadzu GCs (for 0.32/0.53mm ID columns)

Description	Benefits/Uses:	ID**/OD & Length (mm)	Similar to Shimadzu part #	ea.	cat.# 5-pk.	25-pk.
 128mm Uniliner®	trace, active samples, high recovery & linearity	3.5 ID 5.0 OD x 128	—	20872	20873	—
 128mm Cyclo-Uniliner®	trace, dirty, high MW active samples, high linearity	3.5 ID 5.0 OD x 128	—	20874	20875	—
 99mm Uniliner®	trace, active samples, high recovery & linearity	3.5 ID 5.0 OD x 99	—	20876	20877	—
 99mm Cyclo-Uniliner®	trace, dirty, high MW active samples, high recovery & linearity	3.5 ID 5.0 OD x 99	—	20893	20894	—
 95mm Uniliner® with Wool*	trace, dirty, high MW active samples, high recovery & linearity	3.5 ID 5.0 OD x 95	—	21713	21719	—

17A PTV Liners for Shimadzu GCs

Description	Benefits/Uses:	ID**/OD & Length (mm)	Similar to Shimadzu part #	ea.	cat.# 5-pk.	25-pk.
 17A PTV Liner with Wool*	trace, dirty, high & low MW active samples	1.6 ID 4.0 OD x 95	225-09212-01	21705	21706	21707

Make-up Liners for Shimadzu GCs

Description	Benefits/Uses:	ID**/OD & Length (mm)	Similar to Shimadzu part #	ea.	cat.# 5-pk.	25-pk.
 Detector Make-up Liner	FIDs, ECDs & misc. detectors	1.0 ID 5.0 OD x 75	—	20760	20761	—

See pg. 17 for details on
Siltek™ deactivation.

**This liner is prepacked with fused silica wool. To order glass wool instead, add the suffix "-202" to the liner catalog number.
**Nominal ID at syringe needle expulsion point.*

www.restek.com

Column Installs This End





Column Installs This End

Column Installs This End

Column Installs This End

Direct Injection Liners for PerkinElmer GCs (for 0.32/0.53mm ID columns)

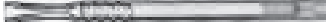
Column Installs This End

DI Liners for PerkinElmer GCs (0.32/0.53mm ID)	Benefits/Uses:	ID**/OD & Length (mm)	Similar to PE part#	ea.	cat.# 5-pk.	25-pk.
 Uniliner®	trace, active samples, high recovery & linearity	3.5 ID 5.0 OD x 100	—	20855	20856	—
 Cyclo-Uniliner®	trace, dirty, active samples, high linearity	3.5 ID 5.0 OD x 100	—	20857	20858	—
 Auto SYS Open-top Uniliner® w/Wool*	trace, dirty, active samples, high recovery & linearity	4.0 ID 6.2 OD x 92.1	—	20837	20838	—
 Auto SYS Cyclo-Uniliner®	trace, dirty, high MW active samples, high linearity	4.0 ID 6.2 OD x 92.1	—	20839	20840	—
 Auto SYS Drilled Uniliner®	allows direct injection when using an EPC- equipped GC	4.0 ID 6.2 OD x 92.1	—	20819	20822	—

PTV Liners for PerkinElmer GCs

Column Installs This End

Description	Benefits/Uses:	ID**/OD & Length (mm)	Similar to PE part #	ea.	cat.# 5-pk.	25-pk.
 PTV Press-Tight®	high linearity for 0.25, 0.32, & 0.53mm ID columns	1.0 ID 2.0 OD x 88	—	20733	20734	20735
 PTV Injector	high linearity	1.0 ID 2.0 OD x 88	—	20742	20743	20744

Direct Injection Liners for 5000-6000 Series Thermo Finnigan GCs (for 0.32/0.53mm ID columns)

Description	Benefits/Uses:	ID**/OD & Length (mm)	Similar to TF part #	ea.	cat.# 5-pk.	25-pk.
 Open-top Uniliner® w/Wool*	trace, dirty, active samples, high recovery & linearity	4.0 ID 5.4 OD x 79.5	—	20841	20842	—

*This liner is prepacked with fused silica wool. To order glass wool instead, add the suffix "-202" to the liner catalog number.

**Nominal ID at syringe needle expulsion point.

**order
prepacked
liners**

Prepacked Liners

Order liners packed with fused silica wool, fused silica beads, glass wool, or CarboFrit™ inserts by adding the appropriate suffix to the inlet liner catalog number.

qty.	Prepacked Inlet Liners Suffix Numbers			
	FS Wool	FS Beads	Glass Wool	CarboFrit™
ea.	-200.1	-201.1	-202.1	-209.1
5-pk.	-200.5	-201.5	-202.5	-209.5
25-pk.	-200.25	-201.25	-202.25	-209.25

†CarboFrit™ inserts require a neck greater than 2mm.

Siltek™-Deactivated Inlet Liners

- Maximize the inertness of the sample pathway.
- Minimize breakdown.
- Low bleed.
- Thermally stable.
- “Clean and green”—manufactured without the use of harmful organic solvents.

For Siltek™ inlet liners, add the corresponding suffix number to the catalog number for your liner. Refer to pages 14-16, or to the Restek Product Guide, for liner catalog numbers.

qty.	Siltek™	Siltek™ with Siltek™ Wool	Siltek™ with CarboFrit†
each	-214.1	-213.1	-216.1
5-pk.	-214.5	-213.5	-216.5
25-pk.	-214.25	-213.25	-216.25

†CarboFrit™ inserts require a neck greater than 2mm.

Standard Deactivation

All Restek Liners Are Deactivated for Superior Inertness



Restek uses unique procedures for deactivating all of our liners. Each lot of liners is evaluated with an endrin breakdown test to ensure inertness. If you need a higher level of inertness for demanding applications such as pesticide analyses, try Siltek™ deactivation, described above. Our base deactivation, described below, is available for amines and basic compound analyses.

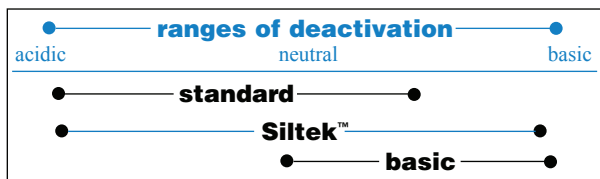

Base-Deactivated Inlet Liners for Agilent GCs

For Amines & Basic Compounds

If the liner you need is not listed here, you can order it on a custom basis by adding the appropriate suffix number. For base deactivation: each (-210.1), 5-pack (-210.5), 25-pack (-210.25). For base-deactivated liners packed with base-deactivated wool: each (-211.1), 5-pack (-211.5), 25-pack (-211.25).

ea.	5-pk.	25-pk.
	4mm Split Straight w/ Wool	
20781-211.1	20782-211.5	20783-211.25
	Cycloplitter®	
20706-210.1	20707-210.5	—
	4mm Splitless Straight	
20772-210.1	20773-210.5	20774-210.25
	2mm Gooseneck	
20795-210.1	20796-210.5	20797-210.25
	4mm Gooseneck	
20798-210.1	20799-210.5	20800-210.25

Restek Enhanced Design

Restek Enhanced Split/Splitless Injection Port for Agilent 5890 GCs

Compact, locking pin-and-slot assembly prevents inlet lines from snapping.

Leak-free injection port seals at temperatures as high as 400°C.

Redesigned injector base improves seal and simplifies column installation.

Uses standard 1/4-inch ferrule instead of sealing disk.

Silcosteel®-treated for an inert sample pathway!

Original liner dimensions and column insertion distances maintained.

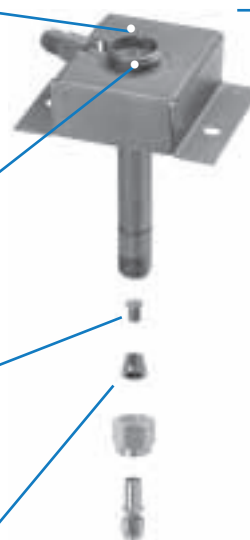

TIP!

Special dual-taper, 1/4-inch ID Vespel®/graphite ferrules fit over split liners (OD 6.3mm). Ferrules with a slightly enlarged ID are required for splitless liners (OD 6.5mm) and are available from Restek.

Description	qty.	cat.#
Complete injection port assembly includes: base fitting, split/splitless weldment, stainless steel base screw, septum nut, 1/16" and 1/4" stainless steel nuts, 1/4" graphite ferrule Silcosteel® Injection Port for Agilent 5890 GCs	kit	22675
Ferrules for split liners (6.3mm OD): 1/4" dual-taper Vespel®/graphite ferrules	10-pk.	20290
Ferrules for splitless liners (6.5mm OD): 1/4" dual-taper Vespel®/graphite ferrule	10-pk.	20291
Silcosteel® Base Screws for Restek 5890 Injection Port	10-pk. 50-pk.	21631 21632
Gold-Plated Base Screws for Restek 5890 Injection Port	2-pk. 10-pk.	21629 21630
Septum Nut	ea.	20631
Base Fitting for Restek 5890 Injection Port	ea.	21626
Silcosteel® Split/Splitless Weldment for Restek 5890 Injection Port	ea.	22677
Silcosteel® Shell Weldment for Restek 5890 Injection Port	ea.	22678

Please note: Complete injection port assembly does not include inlet liner, 1/16" capillary ferrule, or split/splitless liner ferrules. Order separately.

Re-Threading Tool

- Repair worn or damaged threads.
- Multiple uses.
- Built-in guide to prevent cross-threading.



Description	qty.	cat.#
For Agilent split/splitless injection ports	ea.	23018

www.restek.com



1

Due to constant installation, removal, and exposure to extreme temperature changes, threads on GC parts easily become worn and damaged. This can cause a poor seal, and oxygen can enter the system, compromising analytical results and possibly destroying expensive analytical columns.



2

Screw the rethreading tool completely onto the injection port in a clockwise direction. Depending on the severity of thread damage, this may require force.



3

Unscrew the rethreading tool and inspect the threads. Repeat as necessary. When done, wipe clean with methanol to remove any debris.

Direct Replacement Split/Splitless Injection Ports for Agilent GCs

Would you like better performance from your injector? Restek's Silcosteel®-coated split/splitless injector is a direct replacement for Agilent 5890 and 6890/6850 GCs. The injector is manufactured from high-quality stainless steel and meets or exceeds Agilent original equipment specifications. Silcosteel® passivates the metal surface to ensure an inert pathway for the sample, delivering increased performance.

Direct Replacement Split/Splitless Injection Port for Agilent 5890 GCs

Description	Similar to		
	Agilent part #	qty.	cat.#
Replacement Weldment with manual flow	19251-60575	ea.	20265
Replacement Shell Weldment	19251-80570	ea.	20266
Silcosteel® Weldment with manual flow	—	ea.	20267
Silcosteel® Shell Weldment	—	ea.	20268

Direct Replacement Split/Splitless Injection Port for Agilent 6890/6850 GCs

Description	Similar to		
	Agilent part #	qty.	cat.#
Replacement Weldment with EPC	G1544-60575	ea.	22674
Replacement Weldment with manual flow	19251-60575	ea.	20265
Replacement Shell Weldment	G1544-80570	ea.	22673
Silcosteel® Weldment with EPC	—	ea.	22672
Silcosteel® Weldment with manual flow	—	ea.	20267
Silcosteel® Shell Weldment	—	ea.	22671

Replacement Inlet Seals for Agilent 5890/6890/6850 Split/Splitless Injection Ports

- Special grade of stainless steel that is softer and deforms more easily, ensuring a completely leak-free seal.
- Increases column lifetime because oxygen cannot permeate into the carrier gas.
- Reduced noise benefits high-sensitivity detectors (e.g., ECDs, MSDs).
- Silcosteel® seal offers the inertness of glass.
- All seals include washers.

Single-Column Installation Opening Size 0.8mm ID*		0.25/0.32mm ID Dual-Column Installation Opening Size 1.2mm ID		0.53mm ID Dual-Column Installation Opening Size (1/16-inch hole)	
2-pk.	10-pk.	2-pk.	10-pk.	2-pk.	10-pk.
Stainless Steel Inlet Seal*					
21315	21316	20390	20391	20392	20393
Gold-Plated Inlet Seal**					
21317	21318	21305	21306	—	—
Silcosteel® Inlet Seal					
21319	21320	21307	21308	—	—

*0.8mm ID stainless steel inlet seal is equivalent to Agilent part #18740-20880.

**0.8mm ID gold-plated inlet seal is equivalent to Agilent part #18740-20885.

Replacement Cross-Disk Inlet Seal for Agilent GCs

- Ideal for high-flow split applications on Agilent 5890 GCs.

(Similar to Agilent part # 5182-9652.)

0.8mm ID Cross-Disk Inlet Seal for Agilent GCs	2-pk.	10-pk.
Gold-Plated	20477	20476
Silcosteel®	20475	20474
1.2mm ID Cross-Disk Inlet Seal for Agilent GCs	2-pk.	10-pk.
Gold-Plated	21009	21010
Silcosteel®	21011	21012

All seals include washers.



Shell weldment for
Agilent 5890



Split/splitless weldment for
Agilent 5890

Septum nut not included



Weldment and shell weldment for
Agilent 6890/6850



Inlet Seals for Agilent 5890/6890
Split/Splitless Injection Port

Note: We recommend the 1.2mm inlet seal for use with VESPEL®/graphite ferrules or when installing two columns using a two-hole ferrule. Use the 0.8mm inlet seal with graphite ferrules and a single capillary column.

VespeL® Ring Inlet Seal

Reliable leak-tight seal for Agilent GCs.
Ask your Restek representative.

www.restek.com



Finger-Tight Column Nuts

- Allows wrench-free column installations.
- Works with standard or compact (Agilent-style) ferrules.
- Made from high-quality stainless steel.

Description	qty.	cat.#
For use with "short" Agilent-style ferrules	2-pk.	21040
For use with standard 1/16" capillary ferrules	2-pk.	21041
For use with standard 1/16" compression fittings	2-pk.	21042



Finger-Tight Nut

- Rapidly tighten columns without wrenches and avoid overtightened stripped threads.
- Two versions available—both can be used with 0.25, 0.32, or 0.53mm ID columns.

Description	qty.	cat.#
For use with "short" Agilent-style ferrules*	ea.	21311
For use with standard ferrules	ea.	21312

*Similar to Agilent part # 5020-8293 and 5020-8292, except that the Restek nut can be used with Vespel® ferrules.



Capillary Nuts (for Agilent 5890/6890 GCs)

Stainless Steel	Similar to	qty.	cat.#
	Agilent part #		
For use with "short" Agilent-style ferrules	5181-8830	2-pk.	21884
For use with standard ferrules—redesigned to fit a wider variety of 1/16" ferrules	—	2-pk.	20883
Brass	Similar to	qty.	cat.#
	Agilent part #		
For use with "short" Agilent-style ferrules	5181-8830	2-pk.	21878
For use with standard 1/16" -type ferrules	—	2-pk.	21879



1/16-Inch Capillary Inlet Adaptor Fitting Kit

(Split/splitless fitting for 0.25 and 0.32mm ID capillary columns)

Restek has specially engineered a high-precision, 1/16-inch fitting that uses standard size, two-hole capillary ferrules. Our design makes it easier to install capillary columns because the nut protrudes farther from the insulated injection port chamber. The column insertion depth is the same as the original equipment. The fitting kit comes with everything needed for dual-column confirmational analysis using 0.25 and 0.32mm ID capillary columns (two-hole ferrules must be ordered separately).

Description	qty.	cat.#
1/16-inch Capillary Inlet Adaptor Fitting Kit	kit	20633
Replacement Inlet Seal (1.2mm hole)	2-pk.	20390
Replacement Inlet Seal (1.2mm hole)	10-pk.	20391

See previous page for gold and Silcosteel® inlet seals.



Direct Replacement Reducing Nut

Restek offers the replacement reducing nut for Agilent 5890/6890/6850 GCs. It is made from high-quality stainless steel and meets original equipment specifications.

Description	qty.	cat.#
Reducing Nut	ea.	22078



1/8-Inch Capillary Inlet Adaptor Fitting Kit

(Split/splitless fitting for 0.53mm ID capillary columns)

Restek has specially engineered a high-precision, 1/8-inch fitting that uses standard 1/8-inch, two-hole capillary ferrules. Our design makes column installation easy because the nut protrudes farther from the insulated injection port chamber. The column insertion depth is the same as the original equipment. The fitting kit comes with everything needed for installation.

Description	qty.	cat.#
1/8-Inch Capillary Inlet Adaptor Fitting Kit	kit	20645
0.53mm ID Dual-Column Installation	2-pk.	20392
Opening Size (1/16-inch hole) Replacement Inlet Seal	10-pk.	20393

Thermolite® Septa

- Use to 340°C inlet temperatures.
- Each batch tested on FIDs, ECDs, and MSDs to ensure lowest bleed.
- Excellent puncturability.
- Preconditioned and ready to use.
- Do not adhere to hot metal surfaces.
- Packaged in non-contaminating glass jars.



Septum Diameter	25-pk.	50-pk.	100-pk.
5mm ($\frac{3}{16}$ "	20351	20352	20353
6mm ($\frac{1}{4}$ "	20355	20356	20357
7mm	20381	20382	20383
8mm	20370	20371	—
9mm	20354	20358	20362
9.5mm ($\frac{3}{8}$ "	20359	20360	20361
10mm	20378	20379	20380
11mm ($\frac{7}{16}$ "	20363	20364	20365
11.5mm	22385	22386	22387
12.5mm ($\frac{1}{2}$ "	20367	20368	20369
17mm	20384	20385	20386
Shimadzu Plug	20372	20373	20374

InfraRed™ Septa

- Use to 325°C inlet temperatures.
- Preconditioned and ready to use.
- Excellent puncturability.
- Do not adhere to injectors.
- Low bleed.
- Packaged in non-contaminating glass jars.

Septum Diameter	25-pk.	50-pk.	100-pk.
9mm	21417	21418	21419
9.5mm ($\frac{3}{8}$ "	21421	21422	21423
10mm	21424	21425	21426
11mm ($\frac{7}{16}$ "	21427	21428	21429
11.5mm	21430	21431	21432
12.5mm ($\frac{1}{2}$ "	21433	21434	21435
17mm	21436	21437	21438
Shimadzu Plug	21439	21440	21441

IceBlue™ Septa

- Use to 250°C inlet temperatures.
- General-purpose septa.
- Excellent puncturability.
- Preconditioned and ready to use.
- Do not adhere to hot metal surfaces.
- Packaged in non-contaminating glass jars.
- Ideal for SPME.

Septum Diameter	50-pk.	100-pk.
9mm	22381	22382
9.5mm ($\frac{3}{8}$ "	22388	22389
10mm	22390	22391
11mm ($\frac{7}{16}$ "	22392	22393
11.5mm	22383	22384
12.5mm ($\frac{1}{2}$ "	22394	22395
17mm	22396	22397
Shimadzu Plug	22398	22399

handy septum size chart

Instrument	Septum Size
Agilent (HP)	
5880A, 5890, 6890, and 6850	11mm
5700, 5880	9.5/10mm
On-Column Injection	5mm
CE Instruments (TMQ)	
TRACE GC	17mm
Finnigan (TMQ)	
GC 9001	9.5mm
GCQ	9.5mm
GCQ w/TRACE	17mm
QCQ™	9.5mm
TRACE 2000	9.5mm
Fisons/Carlo Erba (TMQ)	
8000 series	17mm
Gow-Mac	
6890 series	11mm
All other models	9.5mm
PerkinElmer	
Sigma series	11mm
900,990	11mm
8000 series	11mm
Auto SYS	11mm
Auto SYS XL	11mm
Pye/Unicam	
All models	7mm
Shimadzu	
All models	Plug
SRI	
All models	Plug
Tracor	
540	11.5mm
550,560	9.5mm
220,222	12.5mm
Varian	
<i>Injector type:</i>	
Packed column	9.5/10mm
Split/splitless	
1078/1079	10/11mm
1177	9mm
1075/1077	11mm



Ferrules

Vespel®/graphite

- Vespel®/graphite ferrules are a 60%/40% blend, offering the best combination of sealing performance and ease of workability.
- Seal with minimal torque, reusable, and preferred for vacuum and high-pressure uses.
- Stable to 400°C.

Graphite

- High-purity, high-density graphite.
- Smoother surface and cleaner edges than conventional graphite ferrules.
- Contain no binders that can off-gas or adsorb analytes.
- Stable to 450°C.

Save \$\$\$!
Buy Restek ferrules in bulk
50-packs!

Capillary Ferrules-Før 1/16-Inch Compression-Type Fittings

Ferrule ID	Fits Column ID	qty.	Graphite	Vespel®/Graphite
0.3mm	< 0.20mm	10-pk.	20233	—
0.4mm	0.25/0.28mm	10-pk.	20200	20211
0.4mm	0.25/0.28mm	50-pk.	20227	20229
0.5mm	0.28/0.32mm	10-pk.	20201	20212
0.5mm	0.28/0.32mm	50-pk.	20228	20231
0.8mm	0.45/0.53mm	10-pk.	20202	20213
0.8mm	0.45/0.53mm	50-pk.	20224	20230
1.0mm	0.75mm*	10-pk.	21058	—
1.6mm	1.00mm*	10-pk.	21060	—

Compact Ferrules for Agilent 5890/6850/6890 GCs

Ferrule ID	Fits Column ID	qty.	Graphite	Vespel®/Graphite
0.4mm	0.25/0.28mm	10-pk.	20250	20238
0.4mm	0.25/0.28mm	50-pk.	20251	20239
0.5mm	0.28/0.32mm	10-pk.	21007	20248
0.5mm	0.28/0.32mm	50-pk.	21008	20249
0.8mm	0.45/0.53mm	10-pk.	20252	20263
0.8mm	0.45/0.53mm	50-pk.	20253	20264
1.0mm	1.00mm	10-pk.	21059	21056
1.6mm	1/16"	10-pk.	21061	21057

Standard Ferrules-Før 1/16", 1/8", and 1/4" - Inch Fittings

Fitting Size	Ferrule ID	qty.	Graphite	Vespel®/Graphite
1/4"	3/16"	5-pk.	—	20258
1/16"	1/16"	10-pk.	20207	20218
1/8"	1/8"	10-pk.	20208	20219
1/8"	red. to 1/16"	10-pk.	20209	20220
1/4"	1/4"	10-pk.	20210	20221
1/4"	red. to 1/8"	10-pk.	20225	20222
1/4"	red. to 1/16"	10-pk.	20226	20223

Two-Hole Ferrules-Før 1/8- and 1/16-Inch Compression-Type Fittings

Fitting Size	Ferrule ID	Fits Column ID	qty.	Vespel®/Graphite
1/16"	0.4mm	0.25mm	5-pk.	20241
1/16"	0.5mm	0.28/0.32mm	5-pk.	20242
1/8"	0.8mm	0.45/0.53mm	5-pk.	20246

Reducing Ferrules

Fitting Size	Ferrule ID	Fits Column ID	qty.	Graphite	Vespel®/Graphite
1/8"	0.4mm	0.25mm	5-pk.	20205	20254
1/8"	0.5mm	0.32mm	5-pk.	20205	20255
1/8"	0.8mm	0.53mm	5-pk.	20206	20215
1/4"	0.4mm	0.25mm	5-pk.	20203	—
1/4"	0.5mm	0.32mm	5-pk.	20203	20257
1/4"	0.8mm	0.45/0.53mm	5-pk.	20204	20217

Blank Ferrules—For 1/16-Inch Fittings

Fitting Size	Ferrule ID	qty.	Vespel®/Graphite
1/16"	no hole	10-pk.	20240

Graphite Ferrules for M4 Fittings for GCQ Thermo Finnigan 8000* & TRACE™ 2000

Ferrule ID	Fits Column ID	Graphite 2-pk.	Graphite 10-pk.
0.4mm	0.18–0.25mm	20280	20281
0.5mm	0.28/0.32mm	20282	20283
0.8mm	0.45/0.50 & 0.53mm	20284	20285

Encapsulated Ferrules—For 1/16-Inch Compression Fittings

- Will not deform and stick in fittings.
- Reusable.
- Less torque needed to seal ferrule.
- Restek's unique blend of graphite provides low fragmentation and outgassing.

Ferrule ID	Fits Column ID	qty.	cat.#
0.4mm	0.25mm	10-pk.	21036
0.5mm	0.28/0.32mm	10-pk.	21037
0.8mm	0.45/0.53mm	10-pk.	21038

PTFE Ferrules

- Upper temperature limit 250°C.
- 100% PTFE; completely inert.
- One-piece design requires no back ferrule.

Fitting Size	Ferrule ID	qty.	cat.#
1/16"	1/16"	10-pk.	21122
1/16"	0.4mm	10-pk.	21123
1/16"	0.5mm	10-pk.	21124
1/16"	0.8mm	10-pk.	21125
1/8"	1/8"	10-pk.	21126
3/16"	3/16"	10-pk.	21127
1/4"	1/4"	10-pk.	21128

HOT techtip

Choosing the Right Ferrule

Although graphite and Vespel®/graphite ferrules each have advantages and disadvantages, the choice of ferrule composition is largely a personal preference. Graphite ferrules are soft, easy to seal, stable to 450°C, and contain no binders that might off-gas. Vespel®/graphite ferrules work better for vacuum and high-pressure applications (e.g., GC/MS) because they will not allow oxygen to permeate into the system, whereas graphite ferrules will. In addition, Vespel®/graphite ferrules do not fragment, which also makes them ideal for GC/MS use. Because Vespel®/graphite ferrules are made from a harder material, they might require retightening after several temperature cycles.

PATENTS & TRADEMARKS

Restek patents and trademarks are the property of Restek Corporation. Other trademarks appearing in Restek literature or on its website are the property of their respective owners. The Restek registered trademarks used here are registered in the United States and may also be registered in other countries.

RESTEK

Lit. Cat.# 59882B

© 2002 Restek Corporation. All rights reserved.
Printed in the U.S.A.

Restek U.S. • 110 Benner Circle • Bellefonte, PA 16823 • 1-814-353-1300 • 1-800-356-1688 • fax: 1-814-353-1309 • www.restek.com

Restek France • phone: +33 (0)1 60 78 32 10 • fax: +33 (0)1 60 78 70 90 • e-mail: restek@restekfrance.fr

Restek GmbH • phone: +49 (0)6172 2797 0 • fax: +49 (0)6172 2797 77 • e-mail: info@restekgmbh.de

Restek Ireland • phone: +44 (0)2890 814576 • fax: +44 (0)2890 814576 • e-mail: restekireland@aol.com

Restek Japan • phone: +81 (3)6459 0025 • fax: +81 (3)6459 0025 • e-mail: restekjapan@restek.com

Thames Restek U.K. LTD • phone: +44 (0)1494 563377 • fax: +44 (0)1494 564990 • e-mail: sales@thamesrestek.co.uk

