

# Determination of Chlorite, Bromate, Bromide, and Chlorate in Drinking Water by Ion Chromatography with an On-Line-Generated Postcolumn Reagent for Sub- $\mu\text{g/L}$ Bromate Analysis

Dave Thomas and Jeff Rohrer  
Thermo Fisher Scientific, Sunnyvale, CA, USA

## Introduction

Public water suppliers treat drinking water with disinfectants to protect public health and give drinking water a pleasant taste and odor. Unfortunately, some of the chemical disinfectants or byproducts of the disinfection process are themselves harmful. For example, chlorine dioxide generates the inorganic oxyhalide disinfection byproducts (DBPs) chlorite and chlorate; hypochlorite treatment may also generate the DBP chlorate;<sup>1</sup> and ozonating source water that contains elevated levels of natural bromide can produce the DBP bromate.<sup>2</sup> Both the World Health Organization (WHO) and the U.S. Environmental Protection Agency (EPA) have listed bromate as a potential carcinogen at the low- $\mu\text{g/L}$  level.<sup>3</sup>

The EPA Stage 1 Disinfectants/Disinfection Byproducts (D/DBP) Rule specifies a maximum contaminant level (MCL) of 10  $\mu\text{g/L}$  for bromate, an MCL of 1000  $\mu\text{g/L}$ <sup>4</sup> for chlorite, and prescribes EPA Method 300.1<sup>5</sup> for compliance monitoring of bromate and chlorite in drinking water. It is expected that when the EPA promulgates Stage 2 of the D/DBP Rule, the MCL for bromate will remain at 10  $\mu\text{g/L}$  and the EPA will propose additional methods for compliance monitoring to add flexibility and improved performance. Until then, the EPA is evaluating new methods with improved performance for D/DBP monitoring, including EPA Method 317.0 (IC-PCR, Dionex [now part of Thermo Scientific] Application Note [AN] 136), EPA Method 321.8 (IC/ICP-MS), and EPA Method 326.0 (IC-PCR).<sup>6-8</sup>

This application note describes an improved ion chromatography (IC) method to quantify oxyhalide DBP anions and bromide at low concentration levels in reagent water, bottled water, and finished drinking water using an approach that is technically equivalent to U.S. EPA

Method 326.0. The oxyhalide anions chlorite, chlorate, bromide, and bromate are separated on a Thermo Scientific™ Dionex™ IonPac™ AS9-HC column and measured by using suppressed conductivity detection (as in EPA Method 300.1), followed by postcolumn reaction (PCR) to enhance detection of bromate. Sensitivity for bromate is improved by more than a factor of 10 through the use of a postcolumn reaction in which hydroiodic acid (HI) generated *in situ* from potassium iodide (KI) reacts with bromate in the column effluent to form the triiodide anion ( $\text{I}_3^-$ ) as shown in the following set of reactions:<sup>9</sup>

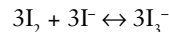
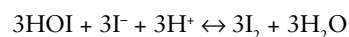

Triiodide is then detected by its strong absorbance at 352 nm.

Because the HI PCR reagent is generated on-line and used immediately, reagent purity and stability should be more easily ensured than in EPA Method 317.0. It is also advantageous from a safety and exposures standpoint to use the *in situ* generated HI versus the toxic *o*-dianisidine (ODA) PCR reagent employed in Method 317.0.

EPA Method 326.0 allows for the determination of all three key oxyhalide anions and bromide at low- $\mu\text{g/L}$  levels using conductivity detection. Bromate can be quantified down to 0.5  $\mu\text{g/L}$  using PCR with UV absorbance detection. Although Method 326.0 is not yet promulgated by the U.S. EPA Office of Ground Water and Drinking Water, the conductivity portion of the method has been determined acceptable for compliance monitoring for the oxyhalide DBPs and bromide.

## Equipment

- Thermo Scientific™ Dionex™ DX-600 Ion Chromatographic System:
  - GP50 Gradient Pump with vacuum degas option
  - ED50A Conductivity Detector with AS50 Conductivity Cell (P/N 55400)
  - AD25 UV/Vis Absorbance Detector with 10 mm cell
  - Thermo Scientific™ Dionex™ AS50 Automated Sampler with thermal compartment
  - PC10 Pneumatic Postcolumn Delivery module (P/N 50601)
  - Thermo Scientific™ Dionex™ AMMS™ 300 Anion MicroMembrane™ Suppressor
- PCH-2 Reaction Heater (P/N 39348)
- Knitted Reaction Coil, 500 μ L, Potted (for PCH-2) (P/N 39349)
- Two 4 L plastic bottle assemblies (for external water mode suppression)
- Thermo Scientific™ Dionex™ Chromeleon™ Chromatography Workstation

## Reagents and Standards

- Deionized water (DI), Type I reagent grade, 18 MΩ-cm resistivity or better
- 0.5 M sodium carbonate (Na<sub>2</sub>CO<sub>3</sub>) anion eluent concentrate (P/N 37162)
- Potassium iodide (KI) (Sigma P-8256) or (Fisher P-410)
- Ammonium molybdate tetrahydrate [(NH<sub>4</sub>)<sub>6</sub> Mo<sub>7</sub>O<sub>24</sub>•4H<sub>2</sub>O] (Aldrich 22,136-6)
- Iron (II) sulfate heptahydrate (FeSO<sub>4</sub>•7H<sub>2</sub>O) (Aldrich 21,542-2)
- Ethylenediamine (EDA) (Alfa Products 11932)
- Dichloroacetic acid (DCAA) (Fluka 35810)
- Sulfuric acid, (18M) (J.T. Baker® Instra-Analyzed® 9673-33)
- Nitric acid, (70%) (J.T. Baker Instra-Analyzed 9598-00)
- Bromate standard, 1000 mg/L, NaBrO<sub>3</sub> in H<sub>2</sub>O (SPEX CertiPrep® AS-BRO39-2Y)
- Bromide standard, 1000 mg/L, NaBr in H<sub>2</sub>O (ULTRA Scientific ICC-001)
- Chlorate standard, 1000 mg/L, NaClO<sub>3</sub> in H<sub>2</sub>O (SPEX CertiPrep AS-CLO39-2Y)
- Chlorite standard, 1000 mg/L, NaClO<sub>2</sub> in H<sub>2</sub>O (SPEX CertiPrep AS-CLO29-2Y)
- Sodium bromide (NaBr) (Aldrich 31,050-6)
- Sodium bromate (NaBrO<sub>3</sub>) (EM SX 03785-1)
- Sodium chlorate (NaClO<sub>3</sub>) (Fluka 71370)
- Sodium chlorite (NaClO<sub>2</sub>) (Fluka 71388, ~80% pure)

## Conditions

Columns:	Dionex IonPac AG9-HC, 50 × 4 mm i.d., Guard (P/N 51791) Dionex IonPac AS9-HC, 250 × 4 mm i.d., Analytical (P/N 51786)
Eluent:	9.0 mM sodium carbonate (Na <sub>2</sub> CO <sub>3</sub> )
Flow Rate:	1.3 mL/min
Temperature:	30 °C
Sample Volume:	225 μL
Detection:	Suppressed conductivity, Thermo Scientific™ Dionex™ Anion Atlas™ Electrolytic Suppressor (P/N 056116), auto-suppression, external water mode, 78 mA Temperature compensation, 1.7%/°C
Expected Background:	~23–26 μS
Expected Backpressure:	~2400 psi
Run Time:	20 min

## PCR Conditions

Detection:	Absorbance at 352 nm
PCR Reagent Flow:	0.26 M potassium iodide at 0.4 mL/min
AMMS III:	0.3 N sulfuric acid at 2.5 mL/min
Postcolumn Heater Temp:	80 °C

## Preparation of Solutions and Reagents

### Reagent Water

Distilled or DI water 18 MΩ-cm or better, free of the anions of interest, and filtered through a 0.2 micron filter.

### Eluent Solution (9 mM Sodium Carbonate)

Dilute 36 mL of 0.5 M sodium carbonate concentrate to 2 L with DI water. Unless the in-line degas option is being used, sparge eluent prior to use with helium or sonicate under vacuum for 10 min.

### Ethylenediamine (EDA) Preservative Solution

Dilute 2.8 mL of ethylenediamine (99%) to 25 mL with reagent water. Prepare the solution fresh monthly.

### Ferrous Iron Solution [1000 mg/L Fe (II)]

Add 0.124 g of ferrous sulfate heptahydrate (FeSO<sub>4</sub>•7H<sub>2</sub>O) to about 15 mL of reagent water containing 6 μL concentrated nitric acid in a 25 mL volumetric flask. Dissolve and bring to volume with reagent water (final pH ~2). Prepare fresh every two days.

### Sulfuric Acid Solution (0.5 N)

Dilute 1.4 mL of concentrated sulfuric acid to 100 mL with reagent water.

### Ammonium Molybdate Solution (2.0 mM)

Add 0.247 g of ammonium molybdate tetrahydrate [(NH<sub>4</sub>)<sub>6</sub> Mo<sub>7</sub>O<sub>24</sub>•4H<sub>2</sub>O] to about 50 mL of reagent water in a 100 mL volumetric flask. Dissolve and bring to volume with reagent water. Store in an opaque plastic bottle and prepare fresh monthly.

## Postcolumn Reagent

Add 43.1 g of potassium iodide to about 500 mL of reagent water in a 1 L volumetric flask and mix to dissolve. Add 215  $\mu\text{L}$  of the ammonium molybdate solution. Bring to volume with reagent water and mix. Remove dissolved gasses by sparging with helium or by sonicating under vacuum for 20 min. Immediately place it in the PC10 reagent delivery vessel and blanket with helium. Protect from light by covering the PC10 module with aluminum foil. The reagent is stable for 24 h under these conditions.

## Stock Standard Solutions

Purchase certified solutions or prepare stock standard solutions by dissolving the corresponding mass of the salt for each of the anions of interest (see Table 1) in DI water and dilute to 100 mL.

Table 1. Masses of compounds used to prepare 100 mL of 1000-mg/L anion standards.

Anion	Compound	Mass (g)
$\text{BrO}_3^-$	Sodium bromate ( $\text{NaBrO}_3$ )	0.1180
$\text{Br}^-$	Sodium bromide ( $\text{NaBr}$ )	0.1288
$\text{ClO}_3^-$	Sodium chlorate ( $\text{NaClO}_3$ )	0.1275
$\text{ClO}_2^-$	Sodium chlorite ( $\text{NaClO}_2$ )	0.1344*

\* Mass of pure (>99%) sodium chlorite. For accurate results, determine the exact purity of  $\text{NaClO}_2$  by using the iodometric titration procedure<sup>14</sup> and adjust the mass of the compound used accordingly. For example, for technical-grade sodium chlorite (80% pure) use  $(0.1344 \text{ g}) (100\%/80\%) = 0.1680 \text{ g}$ .

Prepare a mixed anion calibration stock standard at 20 mg/L by combining 2 mL each of the bromide, chlorite, and chlorate stock standards in a 100 mL volumetric flask. Mix and bring to volume with reagent water. These standards are stable for at least one month when stored at less than 6 °C.

Because bromate decomposes in the presence of chlorite, prepare a bromate-only calibration stock standard at 5 mg/L by adding 0.5 mL of the bromate stock standard to a 100 mL volumetric flask and bringing to volume with reagent water. This standard is stable for two weeks when stored at less than 6 °C.

## Working Standard Solutions

Use DI water to prepare appropriate dilutions of the calibration stock standards as needed. Prepare mixed calibration standards containing all four anions fresh each day as needed.

## Sample Preparation

Sparge the water samples taken from a treatment plant employing chlorine dioxide or ozone with an inert gas (for example, nitrogen, argon, or helium) for 5 min. Add 1.00 mL of EDA preservation solution per 1 L of sample to prevent conversion of residual hypochlorite or hypobromite to chlorate or bromate. This solution also prevents metal-catalyzed conversion of chlorite to

chlorate. Samples preserved in this manner are stable for at least 14 days when stored in amber bottles at 4 °C.<sup>10</sup>

Most samples preserved as above can be filtered through a 0.45-micron filter (Gelman IC Acrodisc®, Pall Corporation, Port Washington, NY, USA, P/N 4485 or equivalent) and directly injected onto the ion chromatograph. However, each sample that contains excess chlorite must be treated to remove chlorite and then reanalyzed for bromate, because elevated levels of chlorite can interfere with the bromate quantification by PCR.

The treatment procedure to remove chlorite requires two portions of the water sample. Place one 10 mL aliquot of the sample into a 20 mL microbeaker. Place a second 10 mL aliquot into a second 20 mL beaker. Fortify one aliquot of the sample with bromate at a level approximating the native concentration of bromate in the untreated sample. This laboratory-fortified matrix (LFM) will indicate correct performance of the chlorite removal step. Acidify both aliquots with 33  $\mu\text{L}$  of 0.5 N sulfuric acid solution and confirm the final pH (5–6) with pH test strips. Add 40  $\mu\text{L}$  of ferrous iron solution, mix, and allow to react for 10 min. Filter the treated samples through a 0.45 micron nylon filter to remove precipitated ferric hydroxide. Then pass the solution through a hydronium-form, cation-exchange cartridge (Thermo Scientific™ Dionex™ OnGuard™ H, P/N 39596) to remove excess soluble iron. The treated samples must be analyzed within 30 h.<sup>11</sup>

## System Preparation and Setup

Configure the IC with the Dionex IonPac AG9/AS9-HC columns and PCR system as depicted in Figure 1 and as described in the PC10 postcolumn delivery system installation instructions. Verify that the pump flow rate is within specifications and recalibrate if necessary. A GP50 pump should deliver water at  $1.0 \pm 0.005 \text{ mL/min}$  against a constant backpressure of 2000 psi. Verify that the UV absorbance detector wavelength accuracy is within specifications. Recalibrate if necessary. It is good practice to periodically record the visible lamp output (that is, the reference cell current in nA) and elapsed time to assist in potential troubleshooting. Consult the pump and detector manuals for procedural details.

Install a 1 mL sample syringe and set the AS50 syringe speed to 4 or 5 to make fast large-loop injections. Install a calibrated 225  $\mu\text{L}$  sample loop made from 111 cm of 0.02 in. i.d. PEEK™ (Victrex plc, Thornton Cleveleys, Lancashire, England) tubing. Enter the correct sample loop size and sample syringe volume in the AS50 Plumbing Configuration screen.

Prepare the Dionex Anion Atlas Electrolytic Suppressor for use by hydrating the eluent chamber. Use a disposable plastic syringe to slowly push approximately 3 mL of DI water through both the Eluent In port and Regen In port. Allow the suppressor to sit for approximately 20 min to fully hydrate the suppressor monodisks and membranes.

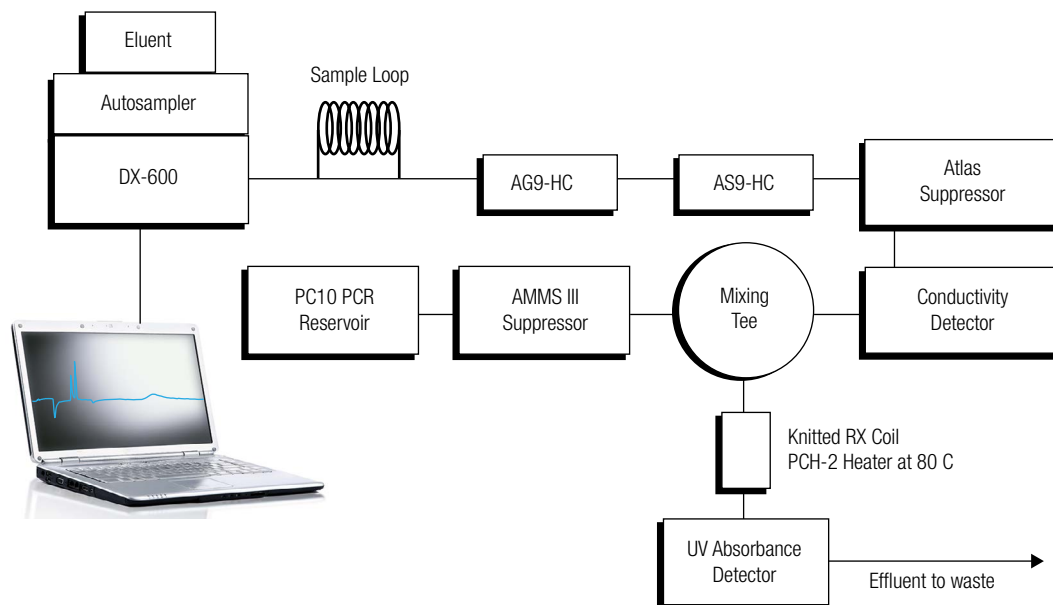

15691-01

Figure 1. IC system configuration for EPA Method 326.0.

Because the effluent from the conductivity detector cell will undergo a postcolumn reaction, install the Dionex Anion Atlas Electrolytic Suppressor in the external water mode by following the *Installation Instructions and Troubleshooting Guide for the Anion Atlas Electrolytic Suppressor* (Document No. 031770). Make sure that the pressure downstream from the Anion Dionex Atlas Electrolytic Suppressor does not exceed the recommended operating pressure of 20–100 psi. Use 0.02 in. i.d. PEEK tubing from the Dionex Anion Atlas Electrolytic Suppressor to the mixing tee, to the PCR coil, to the absorbance detector, and to waste, and keep it as short as is practical to minimize backpressure. Adjust the head pressure on the external water reservoir to deliver a flow rate of 5–10 mL/min (~10–15 psi). Use a current of 78 mA.

Prepare the Dionex AMMS 300 suppressor (P/N 56750) for use by hydrating the eluent chamber. Use a disposable plastic syringe to slowly push approximately 3 mL of 0.2 N sulfuric acid through the Eluent Out port and 5 mL of 0.2 N sulfuric acid through the Regen In port. Allow the suppressor to sit for approximately 20 min to fully hydrate the suppressor screens and membranes. Install the Dionex AMMS 300 suppressor in the chemical regeneration mode by following the *Installation Instructions and Troubleshooting Guide for the Anion Micromembrane Suppressor* (Document No. 031727). Adjust the head pressure on the 0.3 N sulfuric acid reservoir to deliver a flow rate of 2–3 mL/min (~10–15 psi) if a short piece of 0.01 in. i.d. PEEK tubing is connected to the Dionex AMMS 300 suppressor Regen Out port and trimmed accordingly).

Pump the eluent at 1.3 mL/min and set the PC10 pneumatic pressure to 70 psi. To measure the PCR flow rate, collect the effluent from the detector (that is, the total flow from the IC pump and PCR module) in a 10 mL graduated cylinder for 5 min. The PCR flow rate is the difference between the total flow rate and that of the IC pump. Adjust the air pressure of the PC10 postcolumn

delivery module and remeasure the flow rate until the correct PCR flow rate of 0.4 mL/min is established. Variations in the PCR flow rate affect the postcolumn reaction time, pH, dilution, mixing rate, and ratio of the reactants. Stable day-to-day results depend on a well controlled PCR flow rate. Confirm this flow rate on a daily basis and whenever detector response for a calibration check standard deviates beyond quality control acceptance criteria.

The storage solution 10 mM NaHCO<sub>3</sub> is shipped with the Dionex IonPac AS9-HC. After equilibrating the column with 9.0 mM carbonate eluent for 20 min, analyze a system blank of reagent water. An equilibrated system has a background conductance ~26 µS, with the peak-to-peak noise typically 1–2 nS per min. The background absorbance at 352 nm should be less than 200 mAU with peak-to-peak noise of less than 50 µAU per min. There should be no peaks eluting within the retention time window of the bromate anion. The column is equilibrated when two consecutive injections of a standard produce the same retention time for bromate.

## Results and Discussion

Figure 2 shows the chromatograms of a mixed anion standard containing 5 µg/L each of chlorite, bromate, bromide, and chlorate. The top trace (A) was obtained with the conductivity detector and the bottom trace (B) was obtained with the UV/Vis absorbance detector after postcolumn reaction with acidified KI. The bromate peak is baseline resolved from chlorite on both detector channels. However, the response on the absorbance detector after PCR with acidified KI is significantly enhanced compared to the response obtained on the conductivity detector.

Table 2 summarizes the calibration data and method detection limits (MDLs) obtained for the oxyhalide DBP anions and bromide using dual conductivity and UV detection. The MDL for each analyte was established by making eight replicate injections of a reagent water blank

Column: Dionex IonPac AG9-HC, AS9-HC  
 Eluent: 9.0 mM sodium carbonate  
 Temp: 30 °C  
 Flow Rate: 1.3 mL/min  
 Inj. Volume: 225 µL  
 Detection: A. Suppressed conductivity,  
 Dionex Anion Atlas Electrolytic Suppressor,  
 external water mode  
 B. Absorbance, 352 nm

Postcolumn Reagent: Acidified KI  
 PCR Flow Rate: 0.4 mL/min  
 Postcolumn Heater: 80 °C

Peaks A: 1. Chlorite 5 µg/L (ppb)  
 2. Bromate 5  
 3. DCA\*  
 4. Bromide 5  
 5. Chlorate 5

Peak B: 6. Bromate-UV

\* DCA = Dichloroacetate quality control surrogate

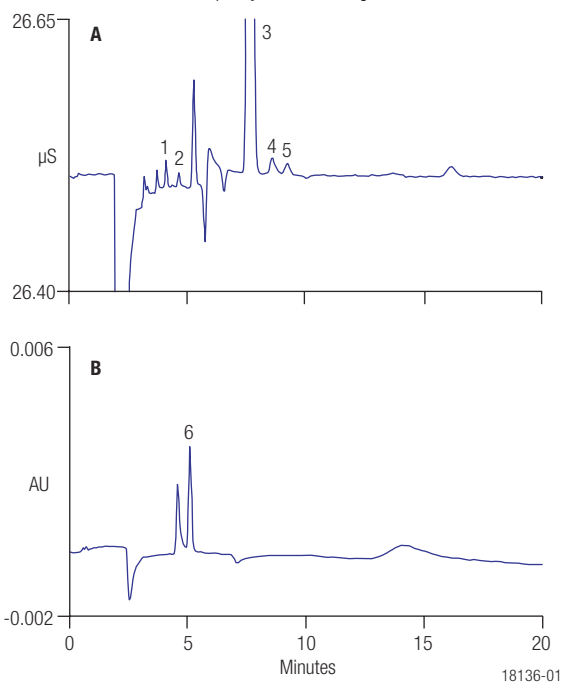

Figure 2. Separation of a low-ppb inorganic anion standard using a Dionex IonPac AS9-HC column; (A) suppressed conductivity detection and (B) UV absorbance detection after PCR with acidified KI.

fortified at a concentration of 3–5 times the estimated instrument detection limit.<sup>12</sup> The use of PCR addition and UV detection allows quantification of bromate down to 0.5 µg/L, without compromising the detection limits obtained with suppressed conductivity detection for the other anions of interest. Electronic smoothing (Olympic, 25 points, 5 sec, 1 iteration) of the UV signal was used to improve the calculated MDL for bromate.<sup>13</sup>

Figures 3–6 illustrate the method's performance for the determination of inorganic oxyhalide DBP anions and bromide in drinking water and bottled water samples. Figure 3 shows the chromatograms from a direct injection of drinking water (from Sunnyvale, CA). The top trace (A) was obtained with the conductivity detector and the bottom trace (B) was obtained with the UV/Vis absorbance detector after postcolumn reaction with acidified KI. Chlorite, bromate, bromide, and chlorate were all observed in the drinking water sample. The target analyte anions were well resolved from the sample matrix. The

Table 2. Linear ranges and MDLs for oxyhalides and bromide.

Solute	Range (µg/L)	r <sup>2</sup>	MDL Standard (µg/L)	Calculated MDL* (µg/L)
Chlorite	5.0–1000	0.9999	5.0	1.10
Bromate-conductivity	5.0–1000	0.9994	5.0	0.82
Bromide	5.0–1000	1.0000	5.0	1.10
Chlorate	5.0–1000	0.9999	5.0	0.85
Bromate-UV	0.5–15	0.9999	0.5	0.06

Column: Dionex IonPac AG9-HC, AS9-HC  
 Eluent: 9.0 mM sodium carbonate  
 Temp: 30 °C  
 Flow Rate: 1.3 mL/min  
 Inj. Volume: 225 µL  
 Detection: A. Suppressed conductivity,  
 Dionex Anion Atlas Electrolytic Suppressor,  
 external water mode  
 B. Absorbance, 352 nm

Postcolumn Reagent: Acidified KI  
 PCR Flow Rate: 0.4 mL/min  
 Postcolumn Heater: 80 °C

Peaks A: 1. Chlorite 1.85 µg/L (ppb)  
 2. Bromate 0.33  
 3. DCA\*  
 4. Bromide 20.3  
 5. Chlorate 89.2

Peak B: 6. Bromate-UV 0.21 µg/L (ppb)

\* DCA = Dichloroacetate quality control surrogate

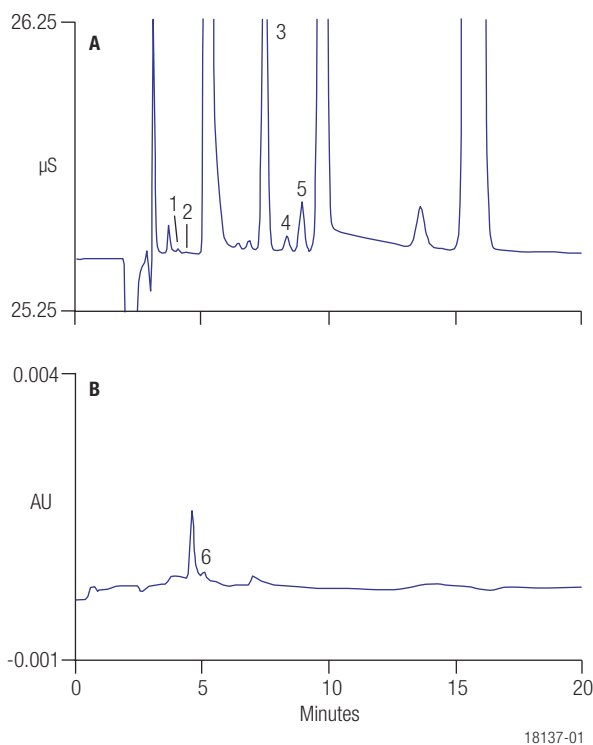

Figure 3. Determination of DBP anions in Sunnyvale, CA, drinking water; (A) suppressed conductivity detection and (B) UV absorbance detection after PCR with acidified KI.

bromide was probably present in the source water. During ozonation, some of the bromide can convert to bromate. Chlorate can enter the water both as a source water contaminant and as a disinfection byproduct from the use of hypochlorite. Chlorite is a residual from treatment with

Column: Dionex IonPac AG9-HC, AS9-HC  
 Eluent: 9.0 mM sodium carbonate  
 Temp: 30 °C  
 Flow Rate: 1.3 mL/min  
 Inj. Volume: 225 µL  
 Detection: A. Suppressed conductivity,  
 Dionex Anion Atlas Electrolytic Suppressor,  
 external water mode  
 B. Absorbance, 352 nm  
 Postcolumn Reagent: Acidified KI  
 PCR Flow Rate: 0.4 mL/min  
 Postcolumn Heater: 80 °C  
 Peaks A: 1. Chlorite\* 14.3 µg/L (ppb)  
 2. Bromate\*\* 1.37  
 3. DCA\*\*\*  
 4. Bromide 32.2  
 5. Chlorate 93.9  
 Peak B: 6. Bromate-UV\*\* 1.43 µg/L (ppb)

\* Chlorite spike 10 ppb

\*\* Bromate spike 1 ppb

\*\*\* DCA = Dichloracetate, quality control surrogate

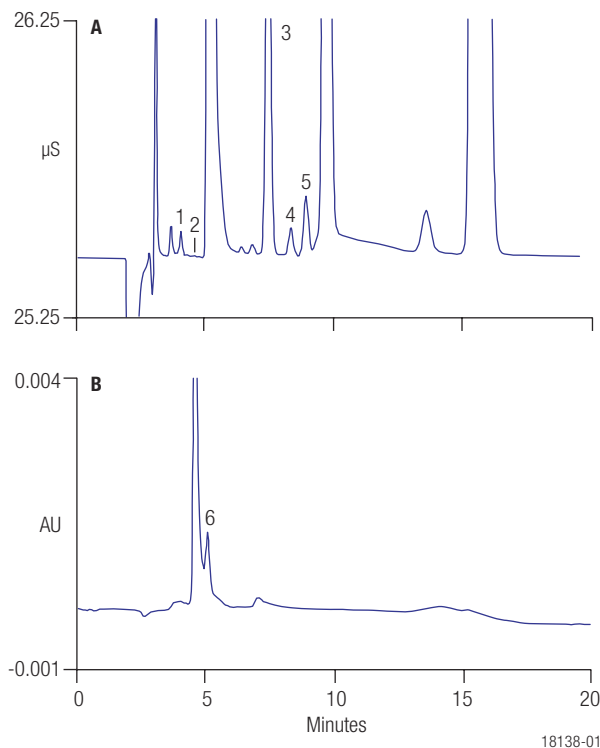

Figure 4. Determination of DBP anions in spiked Sunnyvale, CA, drinking water; (A) suppressed conductivity detection and (B) UV absorbance detection after PCR with acidified KI.

chlorine dioxide.

Figure 4 shows chromatograms of the same drinking water sample spiked with bromate at 1 µg/L, and with chlorite, bromide, and chlorate at 10 µg/L. The top trace (A) was obtained with the conductivity detector and the bottom trace (B) was obtained with the UV/Vis absorbance detector after postcolumn reaction with acidified KI. The benefits of PCR with UV detection for bromate determination can clearly be seen in Figure 4 (B), where the bromate peak response is significantly enhanced compared to the conductivity detector. No response is

Table 3. Anion recoveries for spiked water samples.

Anion*	Tap Water		High-Ionic-Strength Water	
	Amount Added (µg/L)	Recovery	Amount Added (µg/L)	Recovery
Chlorite	10	114%	100	97%
Bromate-conductivity	1	107%	10	98%
Bromide	10	98%	100	105%
Chlorate	10	113%	100	99%
Bromate-UV	1	124%	10	65%***
Bromate-UV**			1.0	106%

\*Data were obtained from multianalyte spikes into Sunnyvale, CA, tap water and high-ionic-strength water (HIW) containing 100 mg/L chloride, 100 mg/L carbonate, 100 mg/L sulfate, 10 mg/L nitrate-N, and 10 mg/L phosphate-P.

\*\* Bromate only (1.0 µg/L) was added to an HIW sample to determine low-level recovery for this anion using UV detection.

\*\*\* Bromate recovery was reduced by chlorite interference.

observed for the large chloride peak that elutes immediately after bromate. Table 3 shows that quantitative recoveries were obtained for the oxyhalide anions and the bromide spiked into drinking water. In addition, quantitative recoveries were obtained for the oxyhalide anions and bromide spiked into the simulated high-ionic-strength water (HIW) that contained elevated levels of the common matrix anions: chloride, carbonate, sulfate, nitrate, and phosphate. The use of PCR with UV/Vis detection allows the quantification of bromate down to 0.5 µg/L in the presence of 100 mg/L chloride (a 200,000-fold excess) with no sample pretreatment.

Figure 5 shows the chromatograms from a direct injection of bottled water. The top trace (A) was obtained with the conductivity detector, and the bottom trace (B) was obtained with the UV/Vis absorbance detector. The bottle label read: "Prepared using filtration, reverse osmosis, deionization, and ozonation". The DBP precursor bromide and the DBP bromate were both observed in the bottled water sample.

Figure 6 shows the chromatograms of the same bottled water sample spiked with bromate at 1.0 µg/L, and with chlorite, bromide, and chlorate at 10 µg/L. The top trace (A) was obtained with the conductivity detector, and the bottom trace (B) was obtained with the UV/Vis absorbance detector after postcolumn reaction with acidified KI. Quantitative recoveries were obtained for all the added oxyhalide anions and bromide.

### Removal of Chlorite Interference

When chlorine dioxide is used to disinfect drinking water, the DBP anion chlorite is found in the finished drinking water. Chlorite, like bromate, reacts with acidified KI and produces a response at 352 nm. High chlorite levels can interfere with quantification of bromate at low concentra-

Column: Dionex IonPac AG9-HC, AS9-HC  
 Eluent: 9.0 mM sodium carbonate  
 Temp: 30 °C  
 Flow Rate: 1.3 mL/min  
 Inj. Volume: 225 µL  
 Detection: A. Suppressed conductivity,  
 Dionex Anion Atlas Electrolytic Suppressor,  
 external water mode  
 B. Absorbance, 352 nm

Postcolumn Reagent: Acidified KI  
 PCR Flow Rate: 0.4 mL/min  
 Postcolumn Heater: 80 °C

Peaks A:	1. Chlorite	n.d.	µg/L (ppb)
	2. Bromate	1.52	
	3. DCA*		
	4. Bromide	1.12	
	5. Chlorate	1.08	

Peak B:	6. Bromate-UV**	1.84	µg/L (ppb)
---------	-----------------	------	------------

\* DCA = Dichloroacetate, quality control surrogate

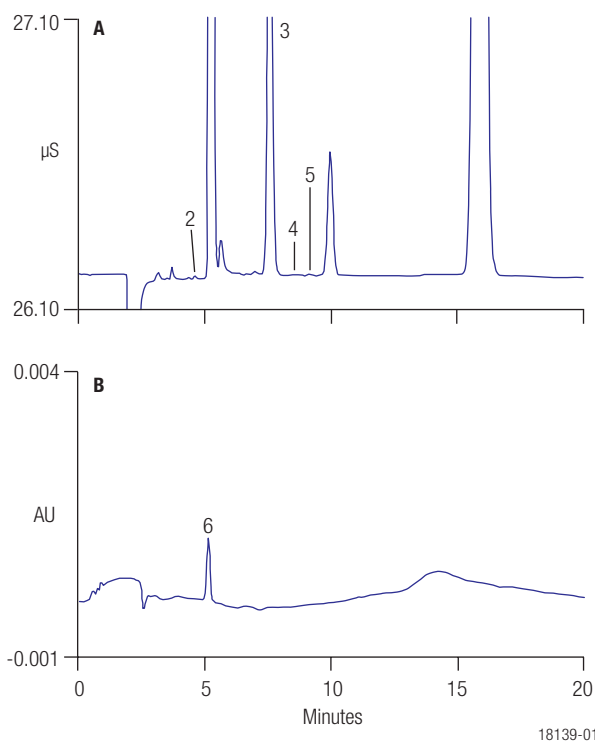

Figure 5. Determination of DBP anions in bottled water; (A) suppressed conductivity detection and (B) UV absorbance detection after PCR with acidified KI.

tions. The interference from chlorite can be minimized by reducing the chlorite with ferrous sulfate, as described in the “Sample Preparation” section. To evaluate the ferrous sulfate treatment, we analyzed a series of simulated chlorine dioxide treated tap waters (STWs) spiked with varying levels of bromate. After determining the bromate level in each STW, we prepared the corresponding LFM s by spiking each STW sample with an amount of bromate

Column: Dionex IonPac AG9-HC, AS9-HC  
 Eluent: 9.0 mM sodium carbonate  
 Temp: 30 °C  
 Flow Rate: 1.3 mL/min  
 Inj. Volume: 225 µL  
 Detection: A. Suppressed conductivity,  
 Dionex Anion Atlas Electrolytic Suppressor,  
 external water mode  
 B. Absorbance, 352 nm

Postcolumn Reagent: Acidified KI  
 PCR Flow Rate: 0.4 mL/min  
 Postcolumn Heater: 80 °C

Peaks A:	1. Chlorite	10.8	µg/L (ppb)
	2. Bromate**	2.80	
	3. DCA*		
	4. Bromide	12.7	
	5. Chlorate	12.6	

Peak B:	6. Bromate-UV**	2.85	µg/L (ppb)
---------	-----------------	------	------------

\* DCA = Dichloroacetate, quality control surrogate

\*\* Bromate spike 1 ppb

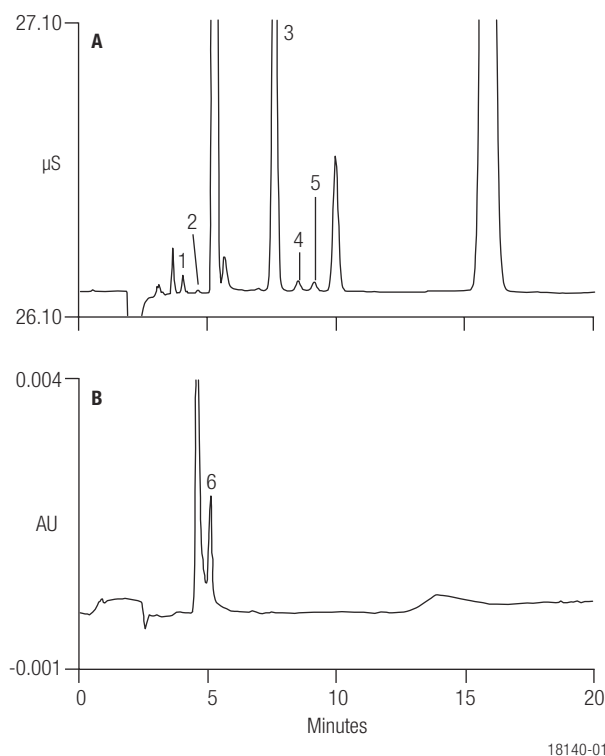

Figure 6. Determination of DBP anions in spiked bottled water; (A) suppressed conductivity detection and (B) UV absorbance detection after PCR with acidified KI.

equal to 50–100% of the observed level. We then treated each STW and its corresponding LFM with ferrous sulfate and reanalyzed. The results, summarized in Table 4 and Figure 7, show that acceptable recoveries of bromate are obtained after such treatment. This treatment approach is recommended when analysis of low-level bromate is required in chlorine dioxide-treated drinking waters.

Table 4. Bromate recovery from simulated chlorine dioxide-treated waters.

Spiked STW Fe (II) Treated				Laboratory Fortified Matrix Fe (II) Treated		
Sample	Amount Added (µg/L)	Amount Found (µg/L)	Recovery	Amount Added (µg/L)	Amount Found (µg/L)	Recovery
STW	0	0.19		0.5	0.61	84%
STW-1	0.5	0.70	102%	0.5	1.20	100%
STW-2	1.0	1.17	98%	1.0	2.24	107%
STW-3	2.0	2.18	100%	2.0	4.33	108%
STW-4	5.0	5.22	101%	5.0	10.24	100%

Column: Dionex IonPac AG9-HC, AS9-HC  
 Eluent: 9.0 mM sodium carbonate  
 Temp: 30 °C  
 Flow Rate: 1.30 mL/min  
 Inj. Volume: 225 µL  
 Detection: Absorbance, 352 nm  
 Postcolumn Reagent: Acidified KI  
 PCR Flow Rate: 0.4 mL/min  
 Postcolumn Heater: 80 °C

Peaks A: 1. Chlorite 100 µg/L (ppb)  
 2. Bromate 0.71

Peaks B: 1. Chlorite\* <1  
 6. Bromate 1.17

\*Chlorite removed using ferrous reagent and a Dionex OnGuard H to remove iron ions.

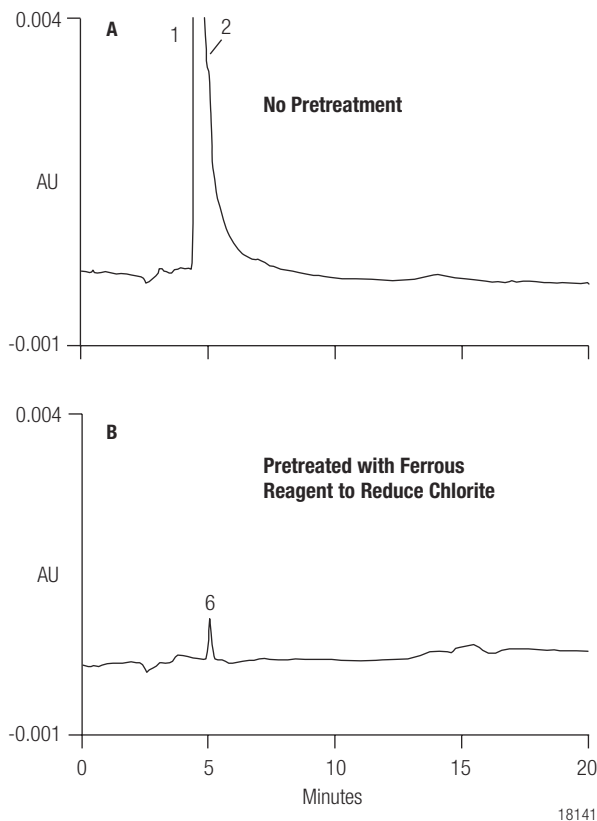

Figure 7. Determination of DBP anions in simulated chlorine dioxide-treated water (STW). (A) Untreated STW, UV absorbance detection after PCR with acidified KI, and (B) STW after treatment with ferrous sulfate to remove chlorite, UV absorbance detection after PCR with acidified KI.

## Summary

The IC method described in this application note uses a Dionex IonPac AS9-HC column and suppressed conductivity detection, followed by postcolumn addition of acidified KI with UV detection, specifically for enhanced bromate response to determine all key oxyhalide anions and bromide at low-µg/L levels in drinking and bottled waters. The postcolumn addition and UV detection allows quantification of bromate at 0.5–15 µg/L without compromising the suppressed conductivity detection of chlorite, bromide, and chlorate. Conductivity detection is recommended for the quantification of bromate at 15–50 µg/L.

## References

- Wagner, H. P.; Pepich, B. V.; Hautman, D. P.; Munch, D. J. *J. Chromatogr. A*, 1999, 850, 119.
- Kruithof, J. C.; Meijers, R. T. *Water Supply*, 1995, 13, 117.
- Fed. Reg.*, 59 (145), 1994, 38709.
- Fed. Reg.*, 63 (241), 1998, 69389.
- U.S. EPA Method 300.1*, U.S. Environmental Protection Agency: Cincinnati, OH, 1997.
- U.S. EPA Method 317.0*, U.S. Environmental Protection Agency: Cincinnati, OH, 2000.
- U.S. EPA Method 321.8*, U.S. Environmental Protection Agency: Cincinnati, OH, 2000.
- U.S. EPA Method 326.0*, U.S. Environmental Protection Agency: Cincinnati, OH, 2002.
- Sahli, E.; Von Gunten, U. *Wat. Res.* 1999, 15, 3229.
- Hautman, D. P.; Bolyard, M. J. *Chromatogr. A* 1992, 602, 65.
- Wagner, H. P.; Pepich, B. V.; Hautman, D. P.; Munch, D. J. *J. Chromatogr. A* 2000, 882, 309.
- Glaser, J. A.; Foerst, D. L.; McKee, G. D.; Quave, S. A.; Budde, W. L. *Environ. Sci. Technol.* 1981, 15, 1426.
- Schibler, J. A. *Am. Lab.* 1997, 63.
- Method 4500-C102.C. In *Standard Methods for the Examination of Water and Wastewater*, 18th Ed.; Greenberg, A. E.; Clesceri, L. S.; Eaton, A. D. (Eds.); APHA: Washington, DC, 1992.



## Suppliers

Aldrich Chemical Co., P.O. Box 2060, Milwaukee, WI 53201 USA, Tel: 800-558-9160, [www.aldrich.sial.com](http://www.aldrich.sial.com).

Alfa Products, 30 Bond St., Ward Hill, MA 01835 USA, Tel.: 800-343-0660, [info@alfa.com](mailto:info@alfa.com).

EM Science, P.O. Box 70, Gibbstown, NJ 08027 USA, Tel: 800-222-0342, [www.emscience.com](http://www.emscience.com).

Fisher Scientific, 2000 Park Lane, Pittsburgh, PA 15275-1126 USA, Tel: 800-766-7000, [www.fishersci.com](http://www.fishersci.com).

Fluka, Box 2060, Milwaukee, WI 53201 USA, Tel: 800-558-9160, [www.sigma-aldrich.com](http://www.sigma-aldrich.com).

J. T. Baker, 222 Red School Lane, Phillipsburg, NJ 08865 USA. Tel.: 800-582-2537, [www.jtbaker.com](http://www.jtbaker.com) (order from VWR).

Sigma Chemical Co., P.O. Box 14508, St. Louis, MO 63178 USA, Tel: 800-325-3010, [www.sigma-aldrich.com](http://www.sigma-aldrich.com).

SPEX CertiPrep, Inc., 203 Norcross Ave., Metuchen, NJ 08840 USA, Tel.: 800-LAB-SPEX, [www.spexcsp.com](http://www.spexcsp.com) (order from Fisher).

ULTRA Scientific (order from VWR).

VWR Scientific Products, 3745 Bayshore Blvd., Brisbane, CA 94005, USA, Tel.: 800-932-5000, [www.vwrsp.com](http://www.vwrsp.com).

## [www.thermofisher.com/dionex](http://www.thermofisher.com/dionex)

©2016 Thermo Fisher Scientific Inc. All rights reserved. Sigma-Aldrich and Fluka are registered trademarks of Sigma-Aldrich Co. LLC. J.T. Baker and Baker Instra-Analyzed are registered trademarks of Avantor Performance Materials, Inc. SPEX CertiPrep is a registered trademark of SPEX CertiPrep Group L.L.C. ULTRA Scientific is a registered trademark of Ultra Scientific, Inc. Acrodisc is a registered trademark of Pall Corporation. PEEK is a trademark of Victrex plc. All other trademarks are the property of Thermo Fisher Scientific Inc. and its subsidiaries. This information is presented as an example of the capabilities of Thermo Fisher Scientific Inc. products. It is not intended to encourage use of these products in any manners that might infringe the intellectual property rights of others. Specifications, terms and pricing are subject to change. Not all products are available in all countries. Please consult your local sales representative for details.

**Australia** +61 3 9757 4486  
**Austria** +43 1 333 50 34 0  
**Belgium** +32 53 73 42 41  
**Brazil** +55 11 3731 5140  
**China** +852 2428 3282

**Denmark** +45 70 23 62 60  
**France** +33 1 60 92 48 00  
**Germany** +49 6126 991 0  
**India** +91 22 2764 2735  
**Italy** +39 02 51 62 1267

**Japan** +81 6 6885 1213  
**Korea** +82 2 3420 8600  
**Netherlands** +31 76 579 55 55  
**Singapore** +65 6289 1190  
**Sweden** +46 8 473 3380

**Switzerland** +41 62 205 9966  
**Taiwan** +886 2 8751 6655  
**UK/Ireland** +44 1442 233555  
**USA and Canada** +847 295 7500

**Thermo**  
 S C I E N T I F I C

Part of Thermo Fisher Scientific