

Determination of trace concentrations of oxyhalides and bromide in municipal and bottled waters

Authors

Jingli Hu and Jeffrey Rohrer
Thermo Fisher Scientific,
Sunnyvale, CA, USA

Keywords

Dionex IonPac AS23-4 μ m column, disinfection byproducts, drinking water analysis, suppressed conductivity detection, bromate analysis, Dionex AERS 500 Carbonate Suppressor, Dionex CRD 300, carbonate removal device

Goal

To demonstrate that oxyhalides and bromide can be successfully determined at concentrations required for regulatory standards and guidelines using a Thermo Scientific™ Dionex™ ion chromatography system equipped with a Thermo Scientific™ Dionex™ IonPac™ AS23-4 μ m column, Thermo Scientific™ Dionex™ CRD 300 Carbonate Removal Device, and a Thermo Scientific™ Dionex™ AERS™ 500 Carbonate Anion Electrolytically Regenerated Suppressor.

Introduction

Public water systems are required to treat source water to bring safe drinking water to thousands of households. Disinfection, an essential step in the water treatment process, inactivates dangerous microbes and pathogens. The most commonly used chemical disinfectants are chlorine, chlorine dioxide, chloramine, and ozone.¹ However, the disinfectants themselves can react with naturally occurring materials in the water to form disinfection byproducts (DBPs) that may pose health risks. For example, chlorination of drinking water can produce trihalomethanes, haloacetic acids, and chlorate. Chlorine dioxide treatment generates chlorite and chlorate, and chloramine is known

to generate chlorate.² Ozone reacts with natural sources of bromide found in water supplies to produce bromate. To date, there are no practical methods for removing bromide or its byproduct, bromate; the only solution is to limit bromate formation during the water treatment process. This requires careful monitoring of the bromate concentration to meet drinking water regulations.

Inorganic DBPs, also referred to as DBP anions or oxyhalides, such as bromate, chlorate, and chlorite, are regulated or monitored by regulatory agencies. Bromate has been identified by the International Agency for Research on Cancer as an animal carcinogen and potential human carcinogen.³ Major regulatory bodies worldwide (e.g., the U.S. Environmental Protection Agency (EPA) and the European Commission, U.S. Food and Drug Administration (FDA), and World Health Organization (WHO)) have set a maximum allowable bromate concentration for drinking water at 10 µg/L.^{4,5} In Europe, the limit is lowered to 3 µg/L for bottled natural mineral and spring waters disinfected by ozonation.⁶ Chlorite is regulated by the U.S. EPA at a maximum contaminant level (MCL) of 1 ppm. Although no regulatory determinations have been made to date, chlorate was monitored in the recent unregulated contaminant monitoring rule 3 (UCMR 3) program.

Determination of oxyhalides and bromide are described in U.S. EPA Methods 300.0 part B and 300.1 part B and further demonstrated in U.S. EPA Methods 317 and 326 for high ionic strength water using post-column derivatization. With advances in ion chromatography technology, hydroxide eluent automatically generated from water can be used successfully to measure oxyhalides and bromide using suppressed conductivity (Thermo Scientific Application Note 167). However, these anions can also be determined using carbonate/bicarbonate eluents, as demonstrated in Thermo Scientific Application Note 208, where a Thermo Scientific Dionex IonPac AS23 column was used with Thermo Scientific™ Dionex™ ASRS™ 300 Anion Self-Regenerating Suppressor on a Thermo Scientific™ Dionex™ ICS-2000 IC system.⁷

This application note presents a method based on Application Note 208. Improvements to the original method include:

- A robust Thermo Scientific™ Dionex™ ICS-5000+ HPIC system that combines the benefits of Reagent-Free™ ion chromatography (RFIC™) and high-pressure ion chromatography (HPIC) to simplify and shorten the run.
- The Dionex IonPac AS23-4 µm column, which uses small 4 µm particles that exhibit higher peak efficiency while maintaining the same selectivity as particles in the original Dionex IonPac AS23 column⁸, and provides a good option for analysts who use carbonate/bicarbonate eluents.
- The Dionex CRD 300 Carbonate Removal Device, which removes carbonate from the eluent and the sample after the suppressor, reducing background and improving the detection limit.

This application note provides a solution for analysts who use carbonate/bicarbonate eluents for efficient determination of inorganic DBPs and bromide in both tap water and bottled water.

Experimental Equipment and consumables

- A Thermo Scientific Dionex ICS-5000+ HPIC system including*:
 - Eluent generator
 - Pump with in-line vacuum degas
 - Conductivity detector
 - Column oven temperature control
 - Detector-suppressor compartment temperature control
- Thermo Scientific™ Dionex™ AS-AP Autosampler, with 5000 µL syringe (P/N 074308), 8500 µL buffer line assembly (P/N 075520), 250 µL injection loop (P/N 042953), and 10 mL vial trays
- Thermo Scientific™ Dionex™ EGC 500 K₂CO₃ Eluent Generator Cartridge (P/N 088453)
- Thermo Scientific™ Dionex™ EPM 500 Electrolytic pH Modifier (P/N 088471)
- Thermo Scientific™ Dionex™ EGC Carbonate Mixer, 4 mm (P/N 088468)

- Dionex AERS 500 Carbonate Anion Electrolytically Regenerated Suppressor, 4 mm (P/N 085029)
- Dionex CRD 300 Carbonate Removal Device, 4 mm (P/N 064637)
- Dionex VP Vacuum Pump (P/N 066463)
- Dionex AS-AP Autosampler Vials, 10 mL (P/N 074228)
- Thermo Scientific™ Dionex™ Chromeleon™ 7.2 SR4 Chromatography Data System Workstation

- Thermo Scientific™ Nalgene™ Syringe Filters, PES, 0.2 µm (Fisher Scientific 13 mm, P/N 720-1320 or 25 mm, P/N 09-740-113)
- Air-Tite™ All-Plastic Norm-Ject® Syringes, 5 mL (Fisher Scientific P/N 14-817-28)

* This application can also be executed on a Thermo Scientific™ Dionex™ Integriion™ HPIC™ system.

Reagents and standards

- Degassed deionized (DI) water, 18 MΩ-cm resistance or better
- Sodium and potassium salts, A.C.S. reagent grade or better, for preparing anions standards
- Ethylenediamine, 99% (Sigma-Aldrich®)

Preparation of solutions and reagents

Stock standard solutions

Stock standard solutions (1000 mg/L) were prepared by dissolving the appropriate amounts of the required analytes in 100 mL of DI water according to Table 1. Stock standards for most anions are stable for at least six months at 4 °C. The chlorite standard is stable for only two weeks when stored, protected from light, at 4 °C. The nitrite and phosphate standards are stable for only one month when stored at 4 °C.

Working standard solutions

Diluted working standard solutions were prepared using the 1000 mg/L stock standards. Working standards containing less than 100 µg/L anions should be prepared fresh daily. Six concentrations of calibration standards were used in this study for chlorite, bromate, chlorate, and bromide to cover the expected concentration ranges found in typical environmental samples (Table 2). Another calibration was performed for both systems using simulated bottled water calibration standards with the same concentrations (0.5 mg/L, 2 mg/L, and 10 mg/L) of fluoride, chloride, and sulfate.

Conditions A and B

Columns:	Dionex IonPac AS23-4µm Analytical Column, 4 × 250 mm (P/N 302555) Dionex IonPac AG23-4µm Guard Column, 4 × 50 mm (P/N 302556)
Eluent:	4.5 mM K ₂ CO ₃ /0.8 mM KHCO ₃
Eluent Source:	Dionex EGC 500 K ₂ CO ₃ Eluent Generation Cartridge with Dionex EPM 500 Electrolytic pH Modifier
Flow Rate:	1 mL/min
Injection Volume:	250 µL in Push-Full mode
Column Temperature:	30 °C
Detection:	Suppressed conductivity, Dionex AERS 500 Carbonate (4 mm) Suppressor, recycle mode, 32 mA current A) Without CRD 300 B) With CRD 300 in vacuum mode
Detection/Suppressor Compartment:	25 °C
Cell Temperature:	35 °C
Background Conductance:	A) <20 µs, B) <1.8 µs
System Backpressure:	A) ~3200 psi, B) ~3300 psi
Noise:	A) <1.5 nS/min, B) <1.5 nS/min
Run Time:	35 min

Table 1. Masses of compounds used to prepare 100 mL of 1000 mg/L anion standards.

Analyte	Compound	Amount (mg)
Fluoride	Sodium fluoride (NaF)	221.0
Chlorite	Sodium chlorite (NaClO ₂), 80%	167.6
Bromate	Sodium bromate (NaBrO ₃)	118.0
Chloride	Sodium chloride (NaCl)	164.9
Nitrite	Sodium nitrite (NaNO ₂)	150.0
Chlorate	Sodium chlorate (NaClO ₃)	127.5
Bromide	Sodium bromide (NaBr)	128.8
Nitrate	Sodium nitrate (NaNO ₃)	137.1
Sulfate	Sodium sulfate (Na ₂ SO ₄)	147.9
Phosphate	Potassium phosphate, monobasic (KH ₂ PO ₄)	143.3
Carbonate	Sodium carbonate (NaCO ₃)	176.6

Table 2. Calibration standards preparation (µg/L).

Analyte	Level 1	Level 2	Level 3	Level 4	Level 5	Level 6
Chlorite	10	25	50	125	250	500
Bromate	2	5	10	25	50	100
Chlorate	10	25	50	125	250	500
Bromide	10	25	50	125	250	500

Sample preparation

A bottled water sample was purchased from a local supermarket. Drinking water samples were collected from three locations in Northern California: Sunnyvale, San Mateo, and Cupertino. Samples were filtered through a 0.2 µm PES syringe filter and the first 300 µL of effluent discarded. Samples were then treated with the preservation solution described in the next section.

Preservation solution (EDA)

Dilute 2.8 mL of ethylenediamine (EDA) to 25 mL with DI water according to section 7.4 in U.S. EPA Method 300.1 to prepare a 100 mg/mL EDA solution. Preserve the standards or samples by adding 50 µL of EDA preservation solution (100 mg/mL) per 100 mL of sample.

Dionex CRD 300 Carbonate Removal Device in vacuum mode setup

To set up the Dionex CRD 300 Carbonate Removal Device in vacuum mode, see the Dionex CRD 300 device and VP pump manual for more information.^{9,10} The Dionex CRD 300 Carbonate Removal Device in vacuum

mode uses a vacuum pump to evacuate the regenerant chamber of the device so that CO₂ gas is literally sucked out of the eluent. Figure 1 shows the flow schematic. A bleed tube feeds a trickle of fresh air into the regenerant chamber to constantly sweep out the CO₂ gas. To operate the Dionex CRD 300 device in vacuum mode, plumb the eluent from the Eluent Out of the suppressor and the Eluent In of the Dionex CRD 300 Device. The Eluent Out of the Dionex CRD 300 device is connected to the conductivity cell In and conductivity cell Out is connected suppressor Regen In. Suppressor Regen Out is connected to EPM Regen In. EPM Regen Out goes to waste. Connect the vacuum tubing to the vacuum port of the vacuum pump and to the ballast bottle. Connect a length of 1/8 in. Teflon® tubing from the ballast bottle to the Regen Out of the CRD 300. Connect 15 cm of red PEEK tubing to the Regen In of the Dionex CRD 300 device; this is the air bleed assembly. Begin eluent flow before beginning vacuum operation. Avoid operating the vacuum pump while eluent flow is stopped.

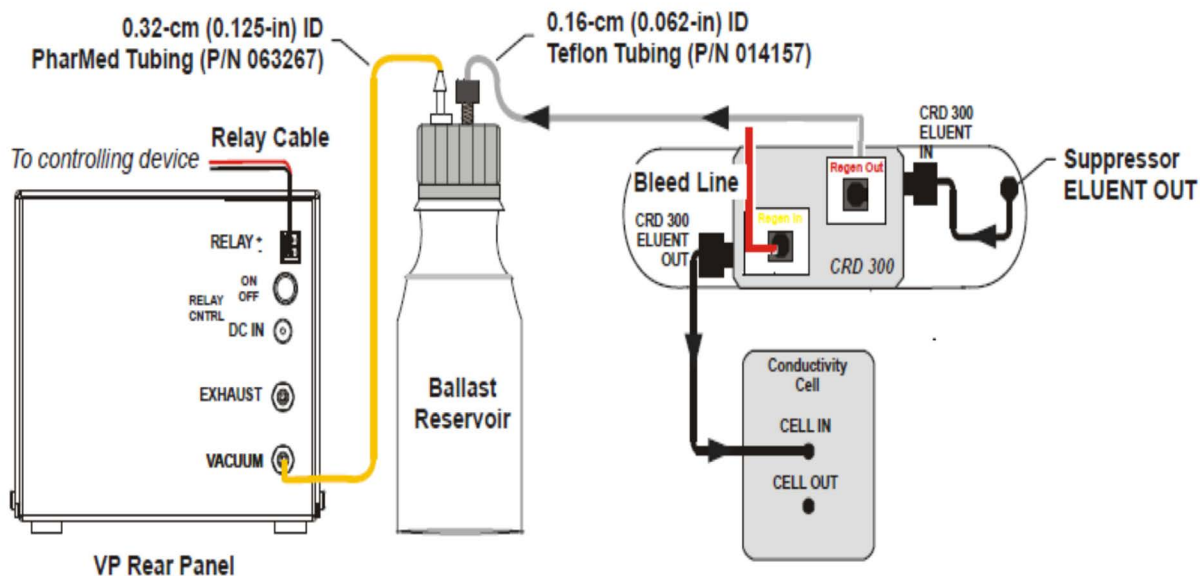

Figure 1. Example flow schematic: Dionex CRD 300 Vacuum Regeneration Mode.

Results and discussion

Separation

Although many labs have adapted to use hydroxide eluent for more sensitive analysis of anions in compliance with U.S. EPA methods, such as EPA Method 300.1 for common anions and other EPA methods for particular anion contaminants, carbonate/bicarbonate eluents are still the choice for many labs. The Dionex IonPac AS23-4 μ m column is a high-capacity anion exchange column specifically designed for use with carbonate/bicarbonate eluent for the determination of trace DBPs, such as chlorite, bromate, and chlorate together with common inorganic anions, including bromide, in drinking water. The high-capacity column allows routine drinking water analysis without sample pretreatment or preconcentration. Another advantage of the Dionex IonPac AS23-4 μ m column is that it has smaller resin particles than the Dionex IonPac AS23 column. Smaller particles lead to more efficient separations, and, therefore, more accurate peak integration and more reliable results. To simplify the method and avoid manual eluent preparation, the Dionex IonPac AS23-4 μ m column can be used with automated carbonate/bicarbonate

eluent generation where electrolytically generated potassium carbonate is modified by an Electrolytic pH Modifier (EPM).

Chromatograms in Figure 2 show that bromate, chlorite, and chlorate were resolved from six common inorganic anions using a Dionex IonPac AS23-4 μ m column in the absence or presence of the Dionex CRD 300 Carbonate Removal Device. The Dionex CRD 300 device was designed to remove carbonate from the eluent and the sample (after suppression), thereby reducing the background conductivity and improving detection limits. Indeed, the background conductivity after suppression using the carbonate eluent shown in Figure 2A is reduced from 18–19 μ S to ~1.8 μ S, as shown in Figure 2B. In addition, with the Dionex CRD 300 device, the water dip (Figure 2A) at about 2 min is greatly reduced in size (Figure 2B), and there is a noticeable improvement in analyte sensitivity. However, the Dionex CRD 300 device introduces extra dead volume to the system and therefore leads to lower peak resolution (Table 3), although all the peaks in Figure 2B are still well resolved.

Column: Dionex IonPac AS23-4 μ m, Analytical, 4 \times 250 mm
 Dionex IonPac AG23-4 μ m, Guard, 4 \times 50 mm
 Eluent: 4.5 mM K₂CO₃/0.8 mM KHCO₃
 Eluent Source: Dionex EGC 500 K₂CO₃ cartridge with EPM 500
 Temperature: 30 °C
 Flow Rate: 1 mL/min
 Inj. Volume: 250 μ L
 Detection: Dionex AERS 500 Carbonate suppressor, 4 mm,
 recycle mode, Current 32 mM
 A) Without a Dionex CRD 300
 B) With a Dionex CRD 300 in vacuum mode

Peaks: 1. Fluoride 0.3 mg/L
 2. Chlorite 1
 3. Bromate 2
 4. Chloride 0.6
 5. Nitrite 1.5
 6. Chlorate 2.5
 7. Bromide 2.5
 8. Nitrate 2.5
 9. Phosphate 4
 10. Sulfate 3

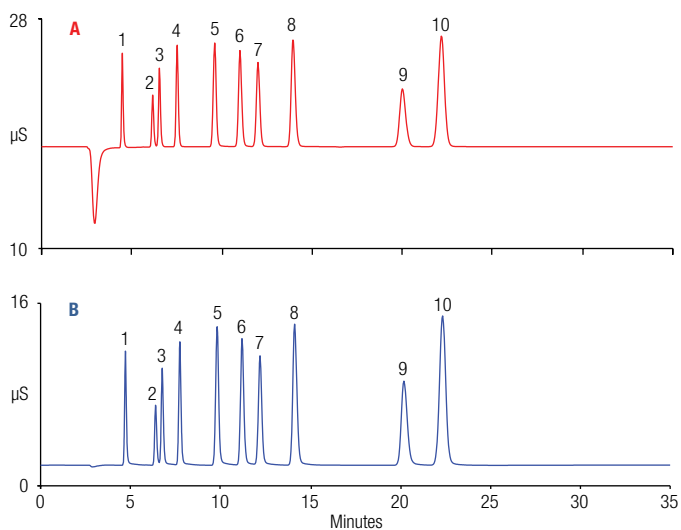

Figure 2. Separation of common anions and disinfection byproduct anions (A) without a Dionex CRD 300 device, and (B) with a Dionex CRD 300 device.

Table 3. Peak area and resolution comparison between systems without and with a Dionex CRD 300 device.

Peak	Analyte	Peak Area (μ S*min)		Resolution	
		Without CRD	With CRD	Without CRD	With CRD
1.	Fluoride	0.763	1.212	9.8	8.79
2.	Chlorite	0.499	0.697	1.95	1.78
3.	Bromate	0.785	1.231	4.8	4.46
4.	Chloride	1.113	1.657	8.04	7.65
5.	Nitrite	1.622	2.513	4.44	4.28
6.	Chlorate	1.606	2.408	2.93	2.91
7.	Bromide	1.499	2.241	5.05	4.99
8.	Nitrate	2.230	3.348	11.71	11.81
9.	Phosphate	1.800	2.924	3.54	3.44
10.	Sulfate	3.621	5.385	n.a.	n.a.

Linearity

To compare the linearity over the calibration range of DBP anions and bromide in the presence or absence of a Dionex CRD 300 Carbonate Removal Device, a six-point calibration range (Table 4A, no CRD 300) and a five-point calibration range (Table 4B, with CRD 300) were used. The five-point range is used because level 6 high concentration standard is outside the linear range. Table 4 shows the linear concentration ranges, the coefficients of determination (r^2), and retention time and peak area precisions from three replicate injections. An example chromatogram from a simulated bottled water calibration standard is shown in Figure 3. The excellent retention time stability and peak area precisions are consistent with results generated from runs using an electrolytically generated high-purity carbonate eluent. The use of such eluent simplifies the method by eliminating the need for manual eluent preparation and by reducing the time for method development.

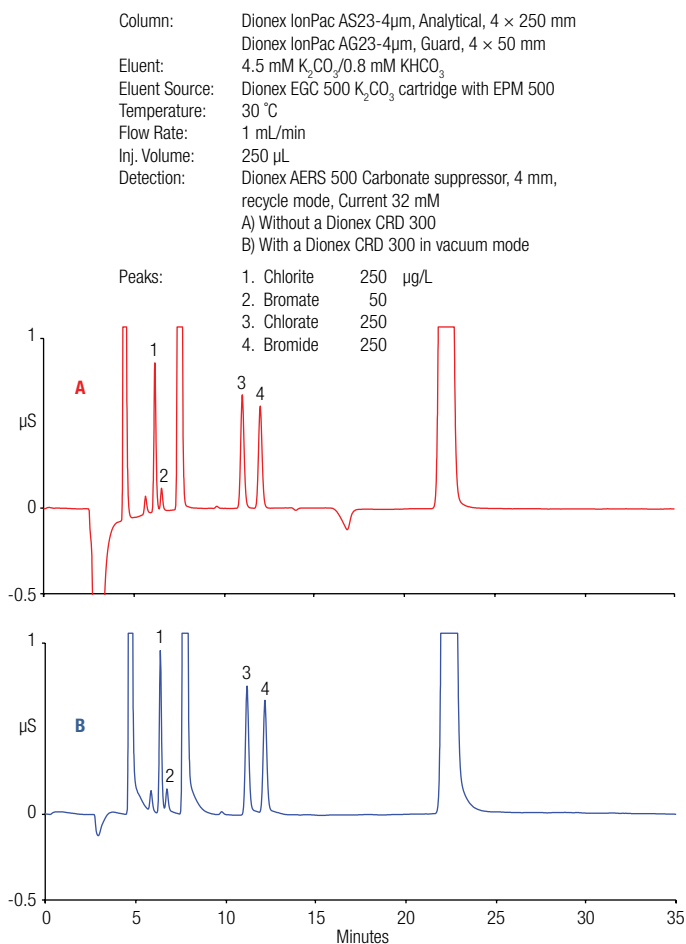

Figure 3. Example chromatograms from a simulated bottled water calibration standard A) without a Dionex CRD 300 device, and B) with a Dionex CRD 300 device.

Table 4A. Linearity and retention time and peak area precisions (n=3) obtained using simulated bottled water calibration standards. Precisions were measured at the highest calibration concentration levels without a Dionex CRD 300 device.

Analyte	Range (μ g/L)	Linearity (r^2)	Retention Time Precision (RSD)	Peak Area Precision (RSD)
Chlorite	10–500	0.9997	<0.1	<0.5
Bromate	2–100	0.9999	<0.1	<1
Chlorate	10–500	0.9999	<0.1	<0.5
Bromide	10–500	0.9996	<0.1	<1

Table 4B. Linearity and retention time and peak area precisions (n=3) obtained using simulated bottled water calibration standards. Precisions were measured at the highest calibration concentration levels with a Dionex CRD 300 device.

Analyte	Range (μ g/L)	Linearity (r^2)	Retention Time Precision (RSD)	Peak Area Precision (RSD)
Chlorite	10–250	0.9992	<0.1	<1.5
Bromate	2–50	0.9992	<0.1	<2
Chlorate	10–250	0.9993	<0.1	<1.5
Bromide	10–250	0.9991	<0.1	<2

Method Detection Limit (MDL)

MDLs were determined by performing seven replicate injections of standards at a concentration of three to five times the estimated instrument detection limits. To make sure the method can be used for routine drinking water testing for inorganic DBPs, we also determined the MDLs using the same concentration of DBP anions in a simulated drinking water standard (fluoride 0.5 mg/L, chloride 50 mg/L, and sulfate 100 mg/L).

Figure 4 shows a separation of a typical MDL standard using the Dionex AERS 500 Carbonate Suppressor with or without the Dionex CRD 300 device. Although the peaks are delayed when the Dionex CRD 300 device is used, again all four analytes are well separated and the calculations of MDLs in two different matrices have been compared in Tables 5A (without Dionex CRD 300 device) and 5B (with Dionex CRD 300 device). The calculated MDLs show no significant difference between the two matrices. However, the MDL for the system with the Dionex CRD 300 device is lower than the MDLs for the system without Dionex CRD 300 device, which is similar to the MDLs determined in AN 208 where a Dionex CRD 300 device is used, but not a Dionex AERS 500 Carbonate Suppressor. These results indicate that the presence of both the Dionex CRD 300 device and Dionex AERS 500 Carbonate Suppressor gives the lowest MDLs

Column: Dionex IonPac AS23-4 μ m, Analytical, 4 \times 250 mm
 Dionex IonPac AG23-4 μ m, Guard, 4 \times 50 mm
 Eluent: 4.5 mM K₂CO₃/0.8 mM KHCO₃
 Eluent Source: Dionex EGC 500 K₂CO₃ cartridge with EPM 500
 Temperature: 30 °C
 Flow Rate: 1 mL/min
 Inj. Volume: 250 μ L
 Detection: Dionex AERS 500 Carbonate suppressor, 4 mm, recycle mode, Current 32 mM
 A) Without a Dionex CRD 300
 B) With a Dionex CRD 300 in vacuum mode

Peaks: 1. Chlorite 3 μ g/L
 2. Bromate 3
 3. Chlorate 3
 4. Bromide 3

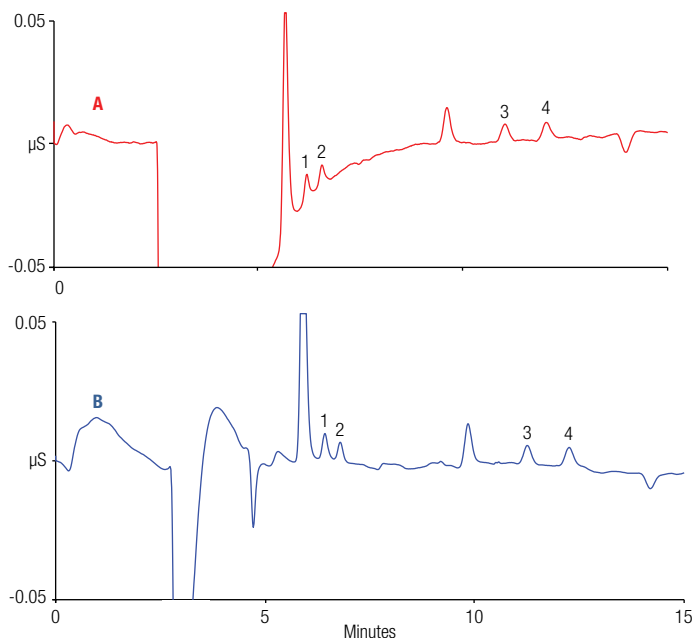

Figure 4. Example chromatograms from the MDL determination A) without a Dionex CRD 300 device, and B) with a Dionex CRD 300 device.

Table 5A. Method detection limits of oxyhalides and bromide in DI water and simulated drinking water without a Dionex CRD 300 device.

Analyte	MDL Standard Conc. (μ g/L)	Calculated MDL in DI H ₂ O (μ g/L ²)	Calculated MDL in Simulated Drinking Water (μ g/L)
Chlorite	2	0.47	0.46
Bromate	3	0.75	0.79
Chlorate	3	0.76	0.82
Bromide	3	0.77	0.78

Table 5B. Method detection limits of oxyhalides and bromide in DI water and simulated drinking water with a Dionex CRD 300 device.

Analyte	MDL Standard Conc. (μ g/L)	Calculated MDL in DI H ₂ O (μ g/L ²)	Calculated MDL in Simulated Drinking Water (μ g/L)
Chlorite	1	0.37	0.34
Bromate	2	0.57	0.63
Chlorate	3	0.66	0.58
Bromide	3	0.52	0.61

for both matrices. Nevertheless, these MDLs are still higher than those determined using the Dionex IonPac AS19-4 μ m column with hydroxide eluent, as in AU203,¹¹ suggesting hydroxide is the better choice for more sensitive analysis of oxyhalide and bromide anions.

Sample accuracy and precision

The performance of the method featuring the Dionex IonPac AS23-4 μ m column was also evaluated through recovery studies using spiked bottled and drinking water samples. Three different brands of bottled water were obtained from a local supermarket and three drinking water samples were collected from Sunnyvale, San Mateo, and Cupertino, CA. Table 6 shows the amount found and the recoveries obtained using the Dionex IonPac AS23-4 μ m column for trace concentrations of DBP anions and bromide spiked in bottled waters. Table 7 shows the recoveries for DBP anions and bromide spiked in drinking waters. Figures 5A and 5B show an overlay of chromatograms of unspiked and spiked bottled water sample #1, and Figures 6A and 6B show an overlay of chromatograms of unspiked and spiked drinking water sample #2. As the two figures

show, the Dionex IonPac AS23-4 μ m column achieves excellent resolution and sensitive detection for oxyhalides and bromide.

According to the criteria outlined in EPA Method 300.1,¹² when the Dionex CRD 300 device is not connected, all anions demonstrate acceptable recoveries (85–115%). In this experiment, recovery was better for the system without the Dionex CRD 300 device than when the Dionex CRD 300 device was used.

The Dionex CRD 300 device adds extra dead volume to the system. Therefore, there is slight peak tailing when the device is connected as shown in Figures 3, 5, and 6. As a result, peak resolution is slightly decreased, as shown in Table 3, and recovery is slightly decreased, as shown in Table 6. However, this effect is compensated by the improvement in analytical performance resulting in lower MDLs, supporting trace bromate analysis using carbonate-based eluents. Optimal performance can be obtained by using suppressed conductivity detection in conjunction with hydroxide-based eluents as described in AU 203.¹¹

Table 6A. Recoveries of trace oxyhalides and bromide spiked in bottled waters (analysis without a CRD).

Analyte	Bottled Water 1			Bottled Water 2			Bottled Water 3		
	Found (μ g/L)	Added (μ g/L)	Recovery (%)	Found (μ g/L)	Added (μ g/L)	Recovery (%)	Found (μ g/L)	Added (μ g/L)	Recovery (%)
Chlorite	<MDL	10	115	<MDL	10	109	<MDL	10	112
Bromate	<MDL	5	93.1	<MDL	5	89.8	<MDL	5	96.4
Chlorate	2.40	10	99.3	2.48	10	97.0	10.3	10	102
Bromide	<MDL	10	93.4	33.2	10	96.9	46.0	10	104

Table 6B. Recoveries of trace oxyhalides and bromide spiked in bottled waters (analysis with a CRD).

Analyte	Bottled Water 1			Bottled Water 2			Bottled Water 3		
	Found (μ g/L)	Added (μ g/L)	Recovery (%)	Found (μ g/L)	Added (μ g/L)	Recovery (%)	Found (μ g/L)	Added (μ g/L)	Recovery (%)
Chlorite	<MDL	10	112	<MDL	10	120	<MDL	10	125
Bromate	<MDL	5	96.3	<MDL	5	84.3	<MDL	5	91.5
Chlorate	4.24	10	90.3	1.57	10	103	9.77	10	87.7
Bromide	<MDL	10	115	29.1	10	93.8	39.3	10	98.1

Column: Dionex IonPac AS23-4µm, Analytical, 4 × 250 mm
 Dionex IonPac AG23-4µm, Guard, 4 × 50 mm
 Eluent: 4.5 mM K₂CO₃/0.8 mM KHCO₃
 Eluent Source: Dionex EGC 500 K₂CO₃ cartridge with EPM 500
 Temperature: 30 °C
 Flow Rate: 1 mL/min
 Inj. Volume: 250 µL
 Detection: Dionex AERS 500 Carbonate suppressor, 4 mm,
 recycle mode, Current 32 mM
 A) Bottled Water
 B) Bottled water spiked with chlorite 10 µg/L, bromate 5 µg/L,
 chlorate 10 µg/L, bromide 10 µg/L

Peaks (A): 3. Chlorate 1.74 µg/L
 Peaks (B): 1. Chlorite 11.5 µg/L
 2. Bromate 4.79 µg/L
 3. Chlorate 11.1 µg/L
 4. Bromide 10.6 µg/L

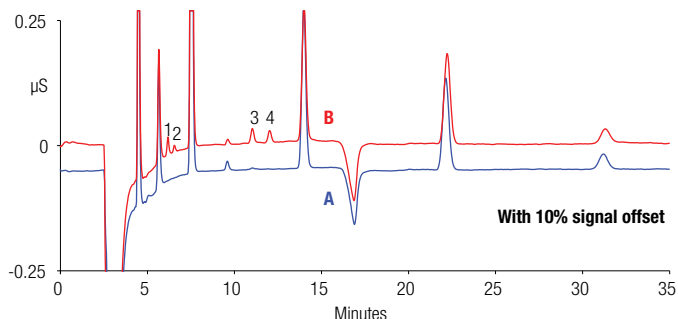

Figure 5A. Determination of DBP anions and bromide in (A) bottled water 1 and (B) spiked bottled water 1 without a Dionex CRD 300 device.

Column: Dionex IonPac AS23-4µm, Analytical, 4 × 250 mm
 Dionex IonPac AG23-4µm, Guard, 4 × 50 mm
 Eluent: 4.5 mM K₂CO₃/0.8 mM KHCO₃
 Eluent Source: Dionex EGC 500 K₂CO₃ cartridge with EPM 500
 Temperature: 30 °C
 Flow Rate: 1 mL/min
 Inj. Volume: 250 µL
 Detection: Dionex AERS 500 Carbonate suppressor, 4 mm,
 recycle mode, Current 32 mM
 A) Bottled Water
 B) Bottled water spiked with chlorite 10 µg/L, bromate 5 µg/L,
 chlorate 10 µg/L, bromide 10 µg/L

Peaks (A): 3. Chlorate 4.48 µg/L
 Peaks (B): 1. Chlorite 13.3 µg/L
 2. Bromate 4.88 µg/L
 3. Chlorate 13.3 µg/L
 4. Bromide 12.4 µg/L

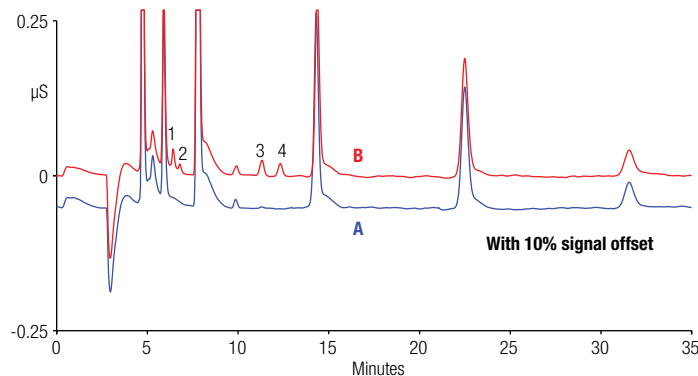

Figure 5B. Determination of DBP anions and bromide in (A) bottled water 1 and (B) spiked bottled water 1 with a Dionex CRD 300 device.

Table 7A. Recoveries of trace oxyhalides and bromide spiked in drinking waters (analysis without a CRD).

Analyte	Drinking Water 1			Drinking Water 2			Drinking Water 3		
	Found (µg/L)	Added (µg/L)	Recovery (%)	Found (µg/L)	Added (µg/L)	Recovery (%)	Found (µg/L)	Added (µg/L)	Recovery (%)
Chlorite	14.9	10	94.7	16.2	10	92.9	<MDL	10	105
Bromate	<MDL	5	89.7	<MDL	5	90.2	<MDL	5	97.8
Chlorate	72.6	100	97.6	125	100	99.9	96.5	100	98.0
Bromide	8.52	10	98.8	6.16	10	103	217	100	100

Table 7B. Recoveries of trace oxyhalides and bromide spiked in drinking waters (analysis with a CRD).

Analyte	Drinking Water 1			Drinking Water 2			Drinking Water 3		
	Found (µg/L)	Added (µg/L)	Recovery (%)	Found (µg/L)	Added (µg/L)	Recovery (%)	Found (µg/L)	Added (µg/L)	Recovery (%)
Chlorite	16.3	10	93.7	16.7	10	85.0	<MDL	10	114
Bromate	<MDL	5	98.7	<MDL	5	95.1	<MDL	5	88.4
Chlorate	69.4	100	99.6	122	100	101	74.3	100	93.9
Bromide	11.2	10	103	10.0	10	102	212	100	95.3

Column: Dionex IonPac AS23-4 μ m, Analytical, 4 \times 250 mm
 Dionex IonPac AG23-4 μ m, Guard, 4 \times 50 mm
 Eluent: 4.5 mM K₂CO₃/0.8 mM KHCO₃
 Eluent Source: Dionex EGC 500 K₂CO₃ cartridge with EPM 500
 Temperature: 30 °C
 Flow Rate: 1 mL/min
 Inj. Volume: 250 μ L
 Detection: Dionex AERS 500 Carbonate suppressor, 4 mm,
 recycle mode, Current 32 mM
 A) Tap water
 B) Tap water spiked with chlorite 10 μ g/L, bromate 5 μ g/L,
 chlorate 100 μ g/L, bromide 10 μ g/L

Peaks (A):
 1. Chlorite 16.4 μ g/L
 3. Chlorate 124
 4. Bromide 6.1
 Peaks (B):
 1. Chlorite 25.8 μ g/L
 2. Bromate 4.5
 3. Chlorate 225
 4. Bromide 15.9

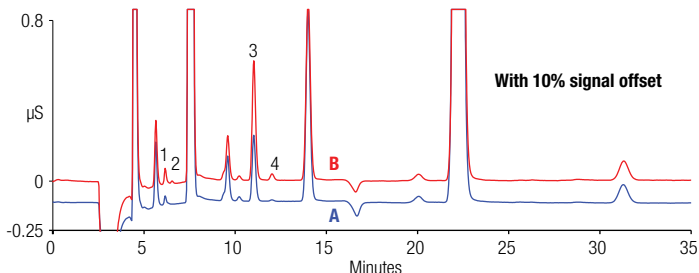

Figure 6A. Determination of DBP anions and bromide in (A) tap water 2 and (B) spiked tap water 2 without a Dionex CRD 300 device.

Column: Dionex IonPac AS23-4 μ m, Analytical, 4 \times 250 mm
 Dionex IonPac AG23-4 μ m, Guard, 4 \times 50 mm
 Eluent: 4.5 mM K₂CO₃/0.8 mM KHCO₃
 Eluent Source: Dionex EGC 500 K₂CO₃ cartridge with EPM 500
 Temperature: 30 °C
 Flow Rate: 1 mL/min
 Inj. Volume: 250 μ L
 Detection: Dionex AERS 500 Carbonate suppressor, 4 mm,
 recycle mode, Current 32 mM
 A) Tap water
 B) Tap water spiked with chlorite 10 μ g/L, bromate 5 μ g/L,
 chlorate 100 μ g/L, bromide 10 μ g/L

Peaks (A):
 1. Chlorite 16.4 μ g/L
 3. Chlorate 124
 4. Bromide 6.1
 Peaks (B):
 1. Chlorite 25.8 μ g/L
 2. Bromate 4.5
 3. Chlorate 225
 4. Bromide 15.9

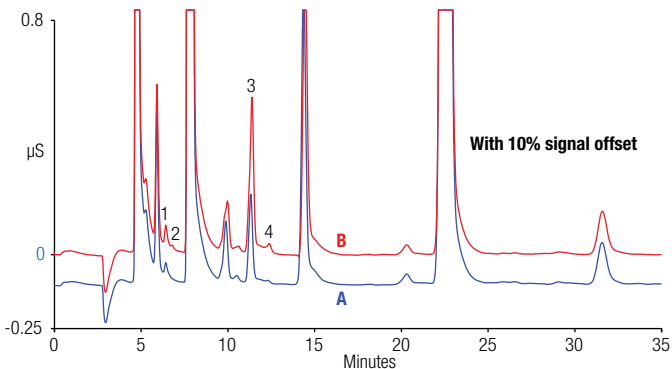

Figure 6B. Determination of DBP anions and bromide in (A) tap water 2 and (B) spiked tap water 2 with a Dionex CRD 300 device.

Conclusion

This study demonstrates that oxyhalides and bromide can be determined accurately in municipal drinking water and bottled water using a Dionex IonPac AS23-4 μ m column with EGC generated carbonate eluent and a Dionex AERS 500 Carbonate Suppressor. The MDLs for oxyhalides and bromide with a Dionex AERS 500 Carbonate Suppressor are less than 0.9 μ g/L and can be reduced to 0.7 μ g/L by adding a Dionex CRD 300 device. The combination of the suppressor and the Dionex CRD 300 device provides great sensitivity for analysts using carbonate/bicarbonate eluents and the Dionex IonPac AS23-4 μ m column provides better resolution. The method described here offers a reliable, robust, easier-to-use, and more sensitive solution for inorganic DBP and bromide determinations in drinking water.

References

1. Drinking water Treatment; EPA 810-F-99-013; U.S. Environmental Protection Agency, 1999.
2. World Health Organization. Disinfectants and Disinfection By-Products; International Programme on Chemical Safety-Environmental Health Criteria 216; Geneva, Switzerland, 2000.
3. Wagner, H.P.; Pepich, B.V.; Hautman, D.P.; Munch, D. J. *J.Chromatogr., A* **1999**, *850*, 119–129.
4. U.S. EPA. National Primary Drinking Water Regulations: Disinfectants and Disinfection Byproducts. Fed. Regist. 1998, 63 (241), 69389-69476.
5. WHO (2005) Background document for Development of WHO Guidelines for Drinking-Water Quality: Bromate in Drinking Water. World Health Organization, WHO/SDE/WSH/05.08/78.
6. European Parliament and Council Directive No. 2003/40/EC, Establishing the List, Concentration Limits and Labeling Requirements for the Constituents of Natural Mineral Waters and the Conditions for Using Ozone-Enriched Air for the Treatment of Natural Mineral Waters and Spring Waters, 2003.
7. Thermo Scientific Application Note 208: Determination of Bromate in Bottled Mineral Water Using the CRD 300 Carbonate Removal Device. [Online] <http://tools.thermofisher.com/content/sfs/brochures/AN-208-IC-Bromate-Bottled-Mineral-Water-AN70405-EN.pdf> (accessed Jan. 3, 2017).
8. Thermo Scientific IonPac AS23-4µm column manual [Online] <https://tools.thermofisher.com/content/sfs/manuals/Man-065711-IonPac-AS23-4um-Man065711-EN.pdf> (accessed Jan. 3, 2017).
9. Thermo Scientific Dionex VP Vacuum Pump Installation Instructions [Online] <http://tools.thermofisher.com/content/sfs/manuals/Man-065186-Installation-VP-Vacuum-Pump-Man065186-EN.pdf> (accessed Jan. 3, 2017).
10. Thermo Scientific Dionex CRD 300 Carbonate Removal Device Product Manual [Online] <https://tools.thermofisher.com/content/sfs/manuals/66619-065213-01-Man-CRD-300.pdf> (accessed Jan. 3, 2017).
11. Thermo Scientific Application Update 203: Determination of Trace Concentrations of Oxyhalides and Bromide in Municipal and Bottled Waters Using a Compact Ion Chromatography System. [Online] <http://tools.thermofisher.com/content/sfs/brochures/AU-203-IC-Oxyhalides-Bromide-Municipal-Bottled-Water-AN72021-EN.pdf> (accessed Jan. 3, 2017).
12. U.S. EPA Method 300.1; U.S. Environmental Protection Agency; Cincinnati, OH, 1997.

Find out more at thermofisher.com/chromatography

ThermoFisher
SCIENTIFIC