

There's a lot to Learn: Tips for Avoiding Pitfalls

Mark Powell
LC Columns Application Engineer
January 19, 2015

Overview

➤ Instrument

- Connections
- Performance

➤ Column

- Characteristics
- Lifetime

➤ Method

- Mobile phase
- Temperature

➤ Sample

- Cleanup
- Injection

Instrument

➤ Fittings

- Connections
 - Improper – Results in areas where the flow does not move smoothly

➤ Tubing

- ID, Length
- No random pieces

➤ Detector

- Flow cell
- Proper settings

LC Connections



- Problems with improper connections
 - Source of leaks
 - **Mistaken for chromatography issues**
- Making connections can vary with skill/technique
- Different manufacturers supply different types of fittings

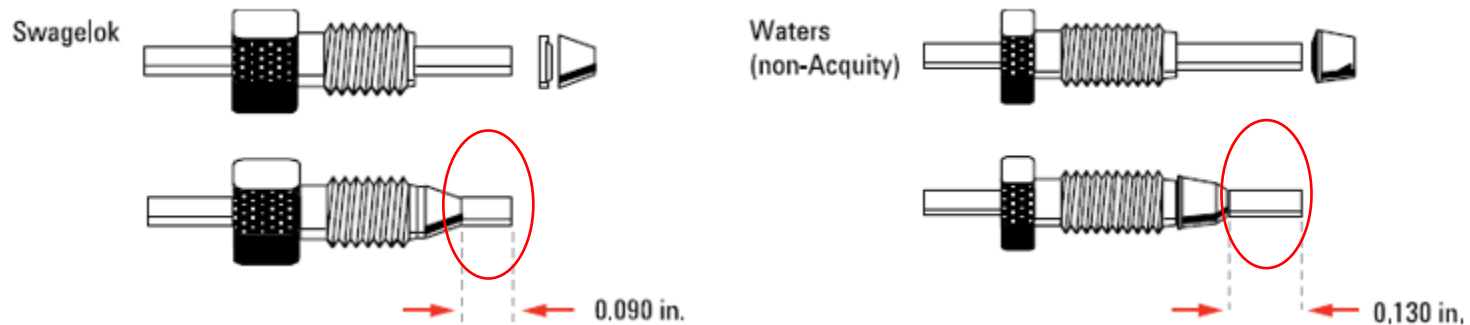

Potential Fittings Issues

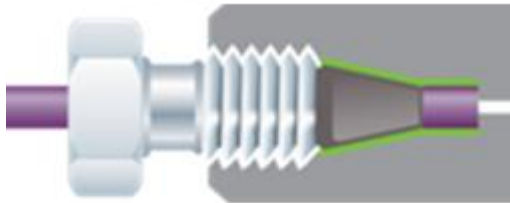

- Leak

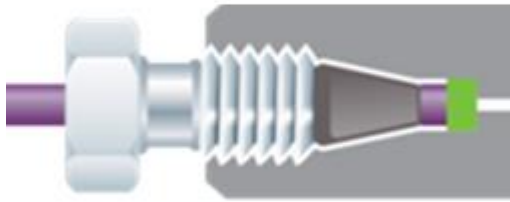

- Peak shape problem

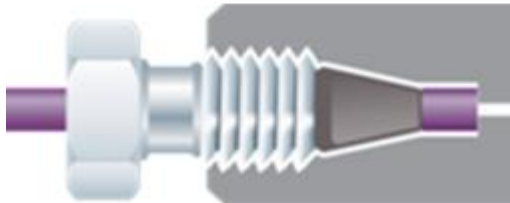

- No dead volume

Fitting Mismatch

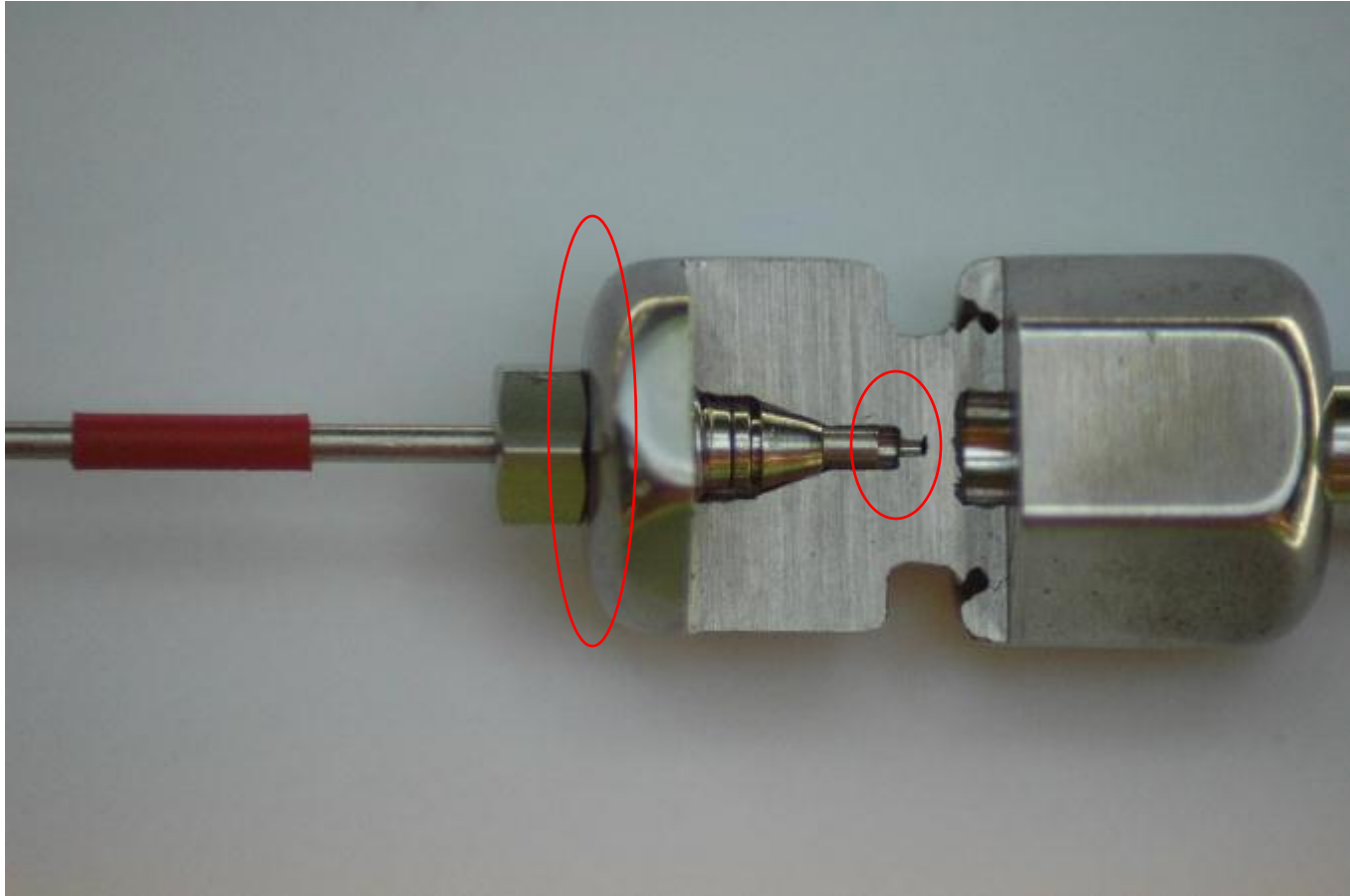

Proper Fit



Peak Shape

— Zero-dead-volume fitting connection
— Fitting connection with dead volume

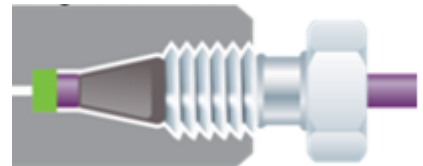
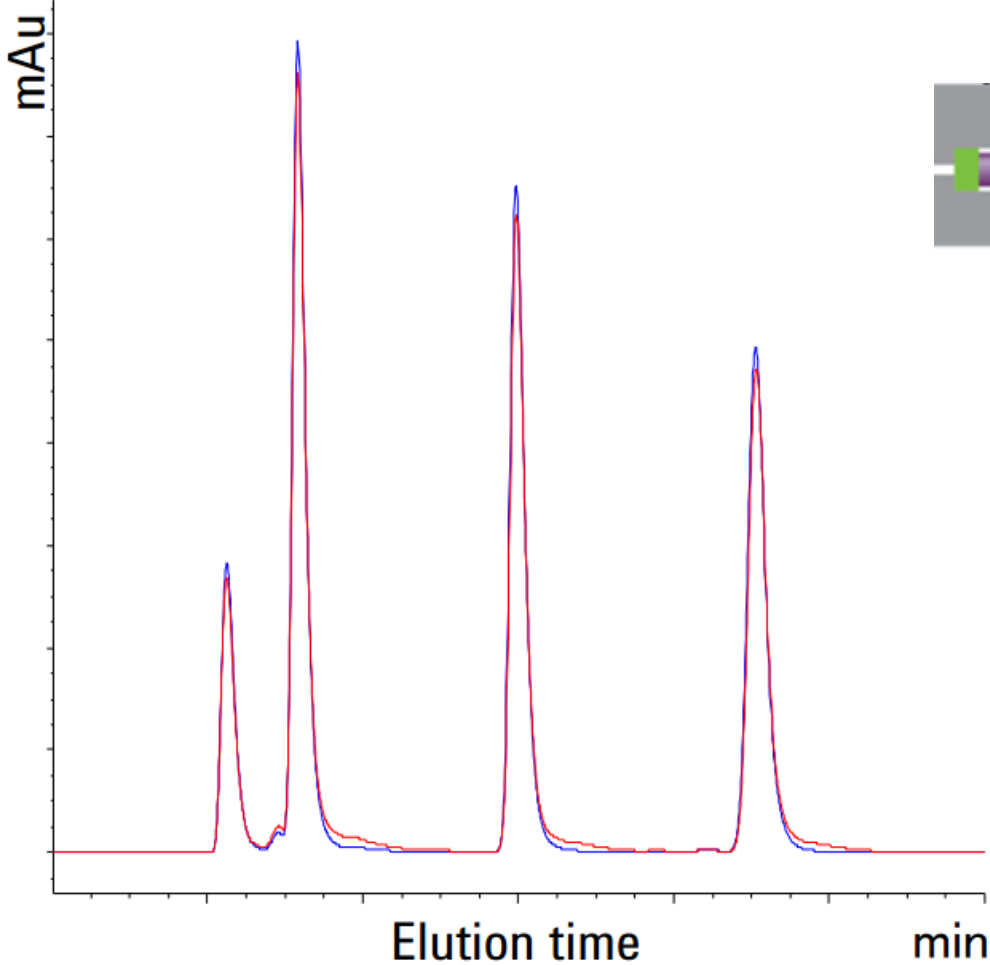

Peak Shape

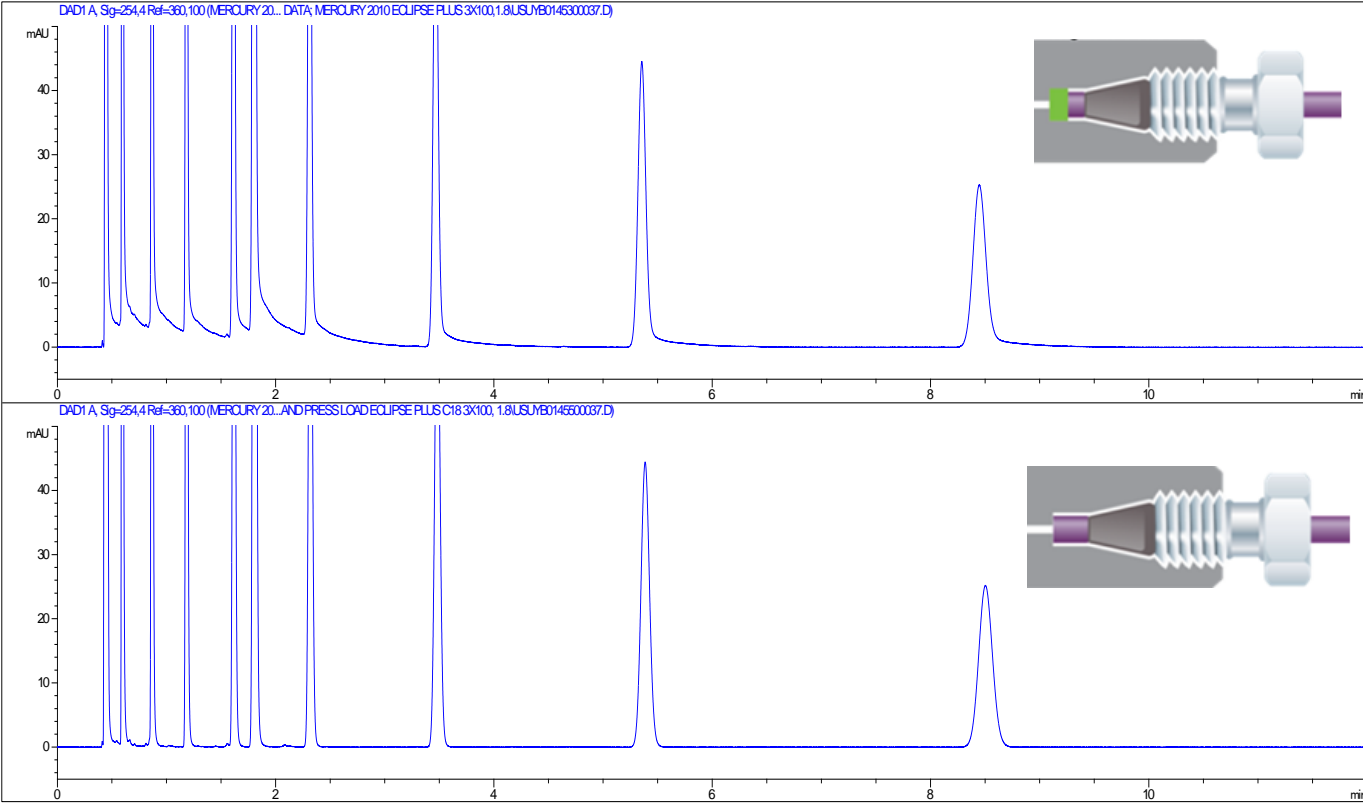

Standard LC fittings: Swaging

Step 1



Select a nut that is the right length for the fitting.

Step 2



Slide the nut over the end of the tubing.

Step 3



Carefully slide the ferrule components on after the nut. Finger-tighten the assembly while making sure the tubing is completely seated in the bottom of the fitting.

Step 4



Use a wrench to gently tighten the fitting by 1/4 to 1/2 turn where you want to connect it; this will force the ferrule to seat onto the tubing. Do not over-tighten!

Step 5



Once you are sure your fitting is complete, loosen the nut and inspect the ferrule for correct position on the tubing.



1/4 in wrench

A-Line Quick Connect Fitting: Unique spring-loaded design



The spring constantly pushes the capillary towards the receiving port.

Guaranteed
zero dead volume

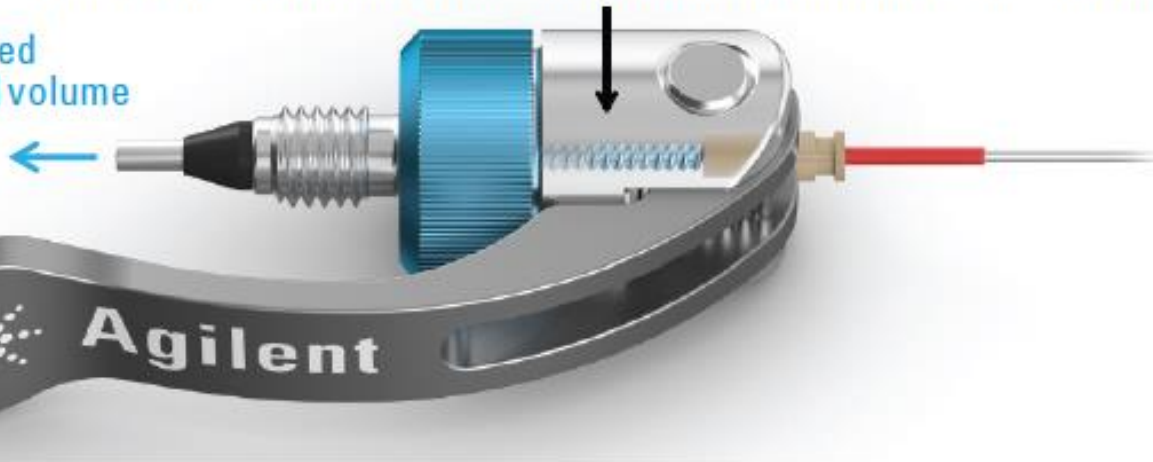

- Unique Spring-loaded design applies a constant force to eliminate dead volume
- Fingertight to 1300 bar

Quick Connect: Leak-free connections with the push of a lever



Finger tight the fitting until you feel the resistance, then close the lever

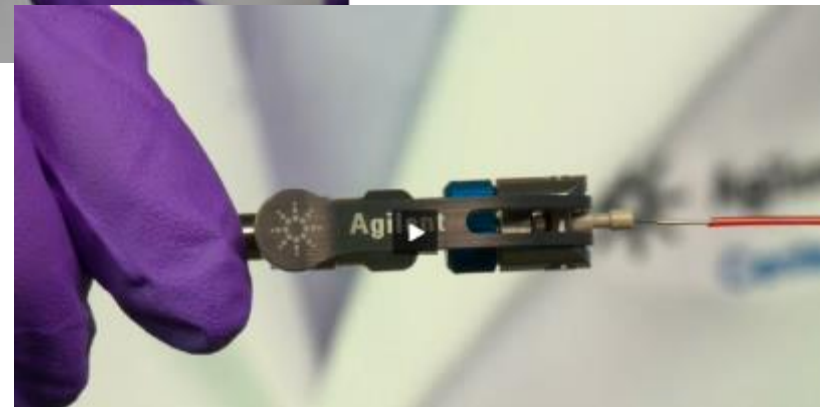

Quick Connect or Quick Turn

The Quick Connect fitting is great for the column connection, where you connect and disconnect most often.

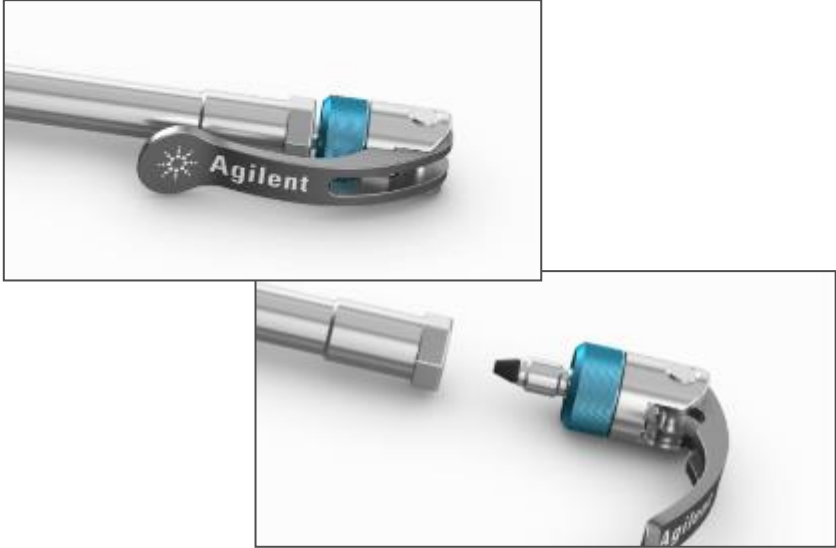

At other points, where there isn't room for the Quick Connect fitting, such as the injector or detector, the Quick Turn fitting is ideal.



A-line Fittings

Agilent A-Line fittings

Getting a perfect column connection, every time, by any operator.



A-Line Quick Turn Fitting



A-Line Quick Connect Fitting

Outcome	Benefit
Easy to use	No tools - Truly finger tight up to 1300 bar.
	Use a Quick Connect fitting for the column inlet and a Quick Turn fitting for the column outlet
	Compatible systems: Agilent 1290, 1260, 1200, 1100 and the Waters Alliance systems
	Works on Agilent as well as competitor columns
	Fast column connection – make multiple column switches in seconds
Time and Cost Savings	Reliable and reusable multiple times – Capillary and ferrule are user changeable
	Eliminate leaks and avoid costly column damage
	Reduce time spent troubleshooting. Avoid costly downtime resulting from bad connections
Better Chromatography	Zero dead volume connections
	Application Flexible - capillary length and the internal diameter is application dependent
	All typical length and internal diameter available for most connections in a modular system

Information about A-line Fittings

Video – how to use the A-Line fittings



Landing page:

www.agilent.com/chem/A-Line

Overview flyer (5991-5164EN)

http://www.agilent.com/cs/library/brochures/5991-5164EN%20A-Line_Flyer.pdf

A-Line Fittings

Technical Overview

<http://www.agilent.com/cs/library/technicaloverviews/public/5991-5525EN.pdf>

Includes ordering info for the A-Line fitting, capillaries and ferrules.

Kits are available for easy ordering.

**LESS STRESS
MORE RELIABLE CONNECTIONS
WITH AGILENT A-LINE SUPPLIES**

Agilent A-Line Quick Connect Fittings

New for all Agilent UHPLC and HPLC systems:

- **Easy to use:** Agilent's new design requires no special training to install, no additional tools or special skills and no heat gun or ultrasonic welding.
- **Spring loaded design:** Agilent's new design allows for easy installation and removal of fittings, even in tight spaces.
- **Reliable and reusable:** Agilent's new design allows for easy installation and removal of fittings, even in tight spaces.
- **Easy to use:** Agilent's new design requires no special training to install, no additional tools or special skills and no heat gun or ultrasonic welding.

Check out the full portfolio of Agilent A-Line products:
www.agilent.com/chem/A-Line

Agilent A-Line Quick Connect Kits

Agilent Technologies

Do NOT Use Random Pieces of Tubing

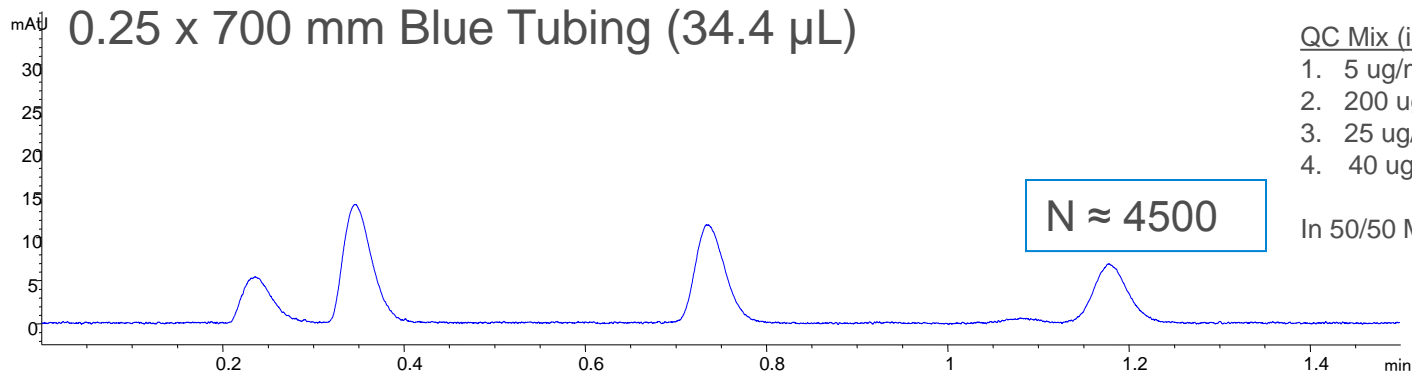
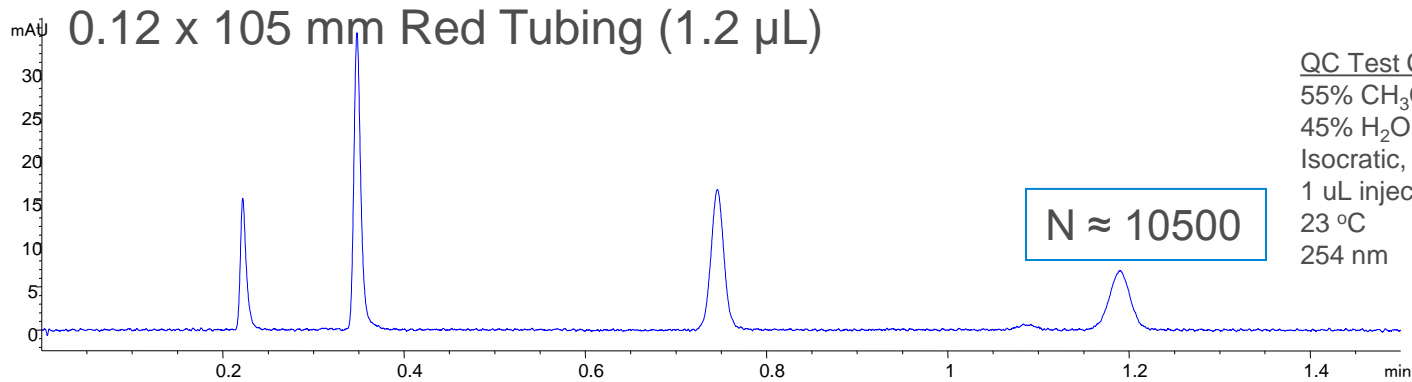

➤ QC test of a 2.1 x 50 mm, 1.8- μ m Eclipse Plus C18 showing peak broadening when larger volume tubing is installed between the autosampler and column. 43% of the efficiency lost with too much extra column volume

➤ To avoid this pitfall - Minimize extra column volume contribution from tubing by using the shortest length you can with the appropriate diameter and make proper connections

UV Detector

➤ Sample

➤ Appropriate wavelength

- Sample
- Reference
 - Selecting Reference Wavelength in DAD Spectroscopy, <http://www.chem.agilent.com/Library/Support/Documents/faq184.pdf>
 - How To Select Reference Wavelength on DAD or MWD, <http://www.chem.agilent.com/Library/Support/Documents/faq182.pdf>
- Mobile phase components
 - UV Cutoff

➤ Flow Cell

➤ Data rate

- Column size
- Response

Flow Cells

Match flow cell volume to chromatographic peak widths



13 µl Standard Flow Cell:

For highest sensitivity and linearity

4.6-3 mm ID; 2.7, 3.5, 5 µm columns

1.7 µl Micro Flow Cell:

For highest resolution

UHPLC, 1.8, 2.7 µm

2.1-1 mm ID columns

5 µl Semi-micro Flow Cell:

Best compromise of sensitivity & selectivity

HPLC/UHPLC, 1.8 to 5 µm

4.6 – 1 mm ID columns

Other flow cells include:

Max-Light Cartridge cells for Infinity DAD

500 nL for capillary LC

80 nL for nano LC

0.6 mm for Prep LC

Flow Cell Volume/Pathlength	Uv Signal /Noise	Chrom. Resolution*
13 µl / 10 mm	+++	+
5 µl / 6 mm	++	++
1.7 µl / 6 mm	+	+++

* Depends on analytical conditions and column dimension

Effect of Detector Response Time on Fast Gradient Analyses

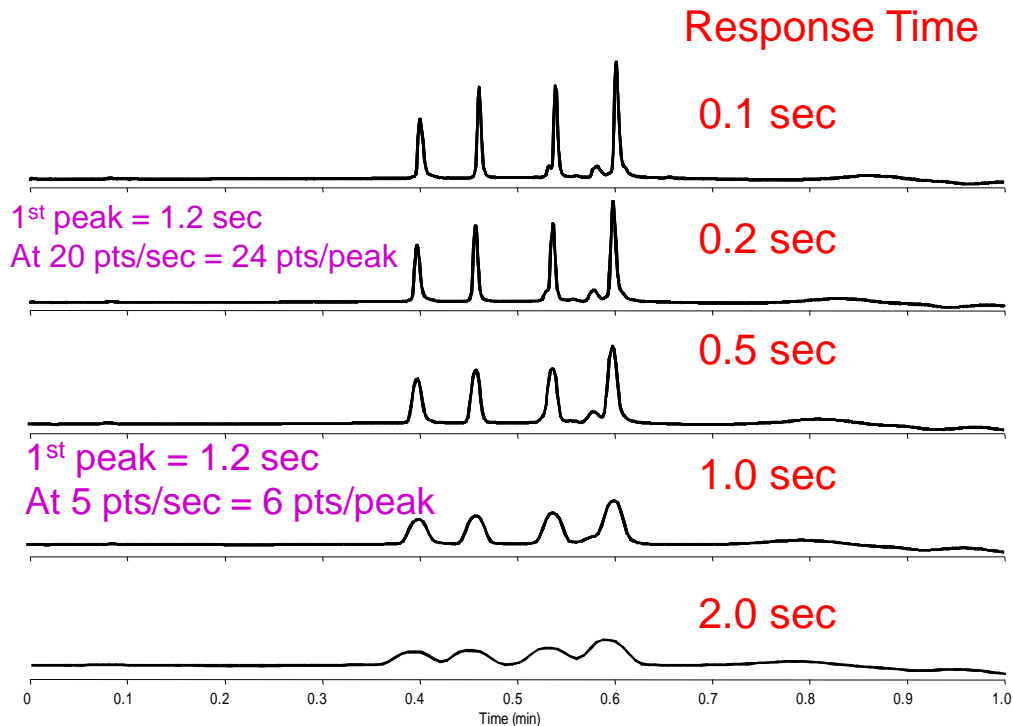

Agilent 1100 DAD
Agilent 1100 WPS with ADVR

Column: Poroshell 300SB-C18
2.1 x 75 mm, 5 mm

Mobile Phase:
A: 95% H₂O, 5% ACN with 0.1% TFA
B: 5% H₂O, 5% ACN with 0.1% TFA

Flow Rate: 2 mL/min

Temperature: 70°C

Detector: UV 215 nm

Piston stroke: 20

Sample:

1. Neurotensin
2. RNaseA
3. Lysozyme
4. Myoglobin

- You may have to adjust the response rate of your detector for rapid peak detection
- To avoid missing the peak, make sure detector is set properly
 - Need ~25 data points to accurately “describe” a chromatographic peak.

http://www.chem.agilent.com//Library/Support/Documents/FAQ_Approved_PDF_Template_enough_datapoints.pdf

Column

- Performance Report
- Not all C18 (L1) columns are the same
- What kills a column
- Pressure
- Guards
- Lot-to-lot

Performance Report

SERIAL NUMBER: USDAZ01333

PART NUMBER: 959758-902
COLUMN TYPE: ZORBAX RRHD Eclipse Plus C18 2.1 x 100 mm, 1.8 µm
PACKING LOT #: B09089

TEST CONDITIONS
MOBILE PHASE = 60% Acetonitrile / 40% Water
COLUMN PRESSURE = 517.2 Bar
COLUMN FLOW = 0.50 ml / min
LINEAR VELOCITY = 0.436 cm / sec
TEMPERATURE = AMBIENT (Nominally 23 °C)
INJECTION VOLUME = 1 µl

QUALITY CONTROL PERFORMANCE RESULTS FOR NAPHTHALENE

TEST VALUES

THEORETICAL PLATES = 22337
SELECTIVITY = 1.90
USP TAILING FACTOR = 1.08
(@ 5% Peak Height)
k' = 4.58

SPECIFICATIONS

MIN = 21000
RANGE = 1.82 - 1.92
RANGE = 0.98 - 1.20

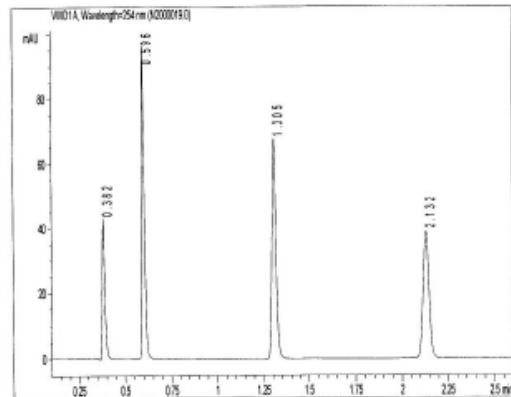

Sample components with concentrations diluted in mobile phase in the following elution order.

Peak #	Conc (ug/ml)	Sample Component
1	10	Uracil
2	400	Phenol
3	50	4-Chloro Nitrobenzene
4	80	Naphthalene

- Manufacturing test chromatogram is done on a modified LC system to minimize extra column volume and will differ from a typical lab instrument
- Don't expect to get the exact same result as the performance report
- Test column performance on your instrument to have as a reference

Not All C18s Are The Same

1st choice

Best Resolution
& Peak Shape

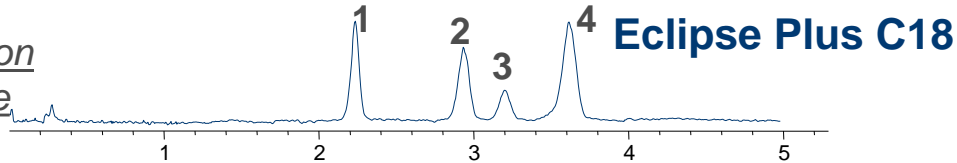

2nd choice

Good alternate selectivity
due to non-encapped

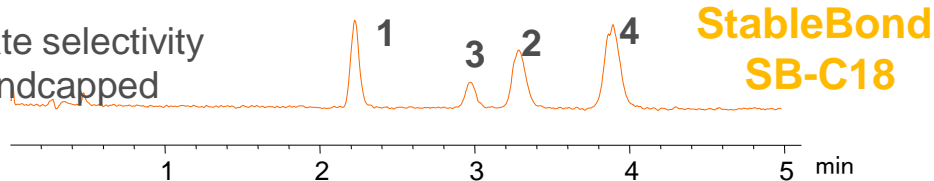

3rd choice

Good efficiency & peak shape
Resolution could be achieved

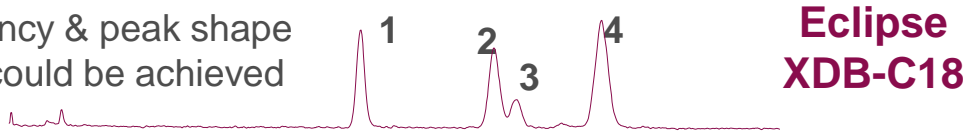

4th choice

Resolution not likely,
Other choices better for this
separation.

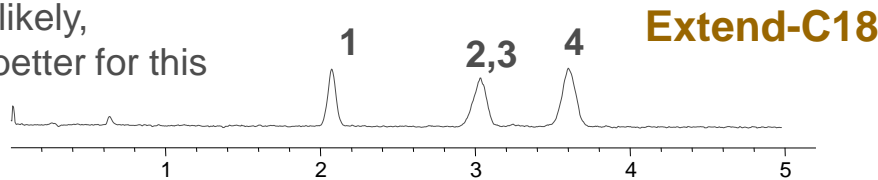

Mobile phase: (69:31) ACN: water
Flow 1.5 mL/min.

Temp: 30 °C

Detector: Single Quad ESI
positive mode scan

Columns: RRHT
4.6 x 50 mm 1.8 um

Sample:

1. anandamide (AEA)
2. Palmitoylethanolamide (PEA)
3. 2-arachinoylglycerol (2-AG)
4. Oleoylethanolamide (OEA)

- Multiple bonded phases for most effective method development
- Match to one you are currently using
- *Method development kits are available*

➤ Don't assume every C18 will behave the same

Method Development Kits

PN	MD Kits	Description
5190-6160	P120, USP Method Dev Kit, 3.0x100mm	Poroshell 120 EC-C18, EC-C8, EC-CN columns, 3.0 x 100 mm
5190-6159	P120, USP Method Dev Kit, 4.6x100mm	Poroshell 120 EC-C18, EC-C8, EC-CN columns, 4.6 x 100 mm
5190-6155	P120, Selectivity Meth Dev, 2.1x50mm	Poroshell 120 EC-C18, Phenyl-Hexyl, Bonus RP columns, 2.1 x 50 mm
5190-6156	P120, Selectivity Meth Dev, 4.6x50mm	Poroshell 120 EC-C18, Phenyl-Hexyl, Bonus RP columns, 4.6 x 50 mm
5190-6157	P120, Aqueous Meth Dev Kit, 2.1x50mm	Poroshell 120 Sb-Aq, Phenyl-Hexyl, Bonus RP columns, 2.1 x 50 mm
5190-6158	P120, Aqueous Meth Dev Kit, 4.6x50mm	Proshell 120 SB-Aq, Phenyl-Hexyl, and Bonus RP columns, 4.6 x 50 mm
5190-6153	RRHD Eclipse Plus Meth Dev Kit, 2.1mm ID	RRHD Eclipse Plus C18, Eclipse Plus C8, Eclipse Plus Phenyl-Hexyl, 2.1 x 50 mm columns
5190-6154	RRHD Aqueous Method Dev Kit, 2.1mm ID	RRHD SB-Aq, Bonus RP, and Eclipse Plus Phenyl-Hexyl column, 2.1 x 50 mm
5190-6152	RRHD pH Method Dev Kit, 2.1mm ID	RRHD StableBond SB-C18, Eclipse Plus C18, and Extend-C18 column, 2.1 x 50 mm
5190-6160	P120, USP Method Dev Kit, 3.0x100mm	Poroshell 120 EC-C18, EC-C8, EC-CN columns, 3.0 x 100 mm
5190-6159	P120, USP Method Dev Kit, 4.6x100mm	Poroshell 120 EC-C18, EC-C8, EC-CN columns, 4.6 x 100 mm
5190-6155	P120, Selectivity Meth Dev, 2.1x50mm	Poroshell 120 EC-C18, Phenyl-Hexyl, Bonus RP columns, 2.1 x 50 mm
5190-6156	P120, Selectivity Meth Dev, 4.6x50mm	Poroshell 120 EC-C18, Phenyl-Hexyl, Bonus RP columns, 4.6 x 50 mm
5190-6157	P120, Aqueous Meth Dev Kit, 2.1x50mm	Poroshell 120 Sb-Aq, Phenyl-Hexyl, Bonus RP columns, 2.1 x 50 mm

Column Lifetime

- Follow manufacturer's guidelines
- Method conditions that can affect column lifetime
 - pH
 - Low pH
 - $\text{pH} < 3$ – acid hydrolysis of bonded phase
 - Retention time changes, resolution changes, increased peak tailing
 - High pH
 - Silica-based packing has some solubility in $\text{pH} > 6$
 - Temperature
 - Improper temp can accelerate the dissolution of the silica above pH 6.
 - Buffer Choice
 - Avoid phosphate & carbonate buffers at high pH
 - Crud
 - Column contamination
 - Plugged frit
- Storage conditions
 - Columns should not be maintained at elevated pH or elevated temperature when not in use

Operational Conditions

Mobile Phase Effects on Column Life

Low pH (1-3) - Bonded Phase Loss by Acid Hydrolysis

Conventional

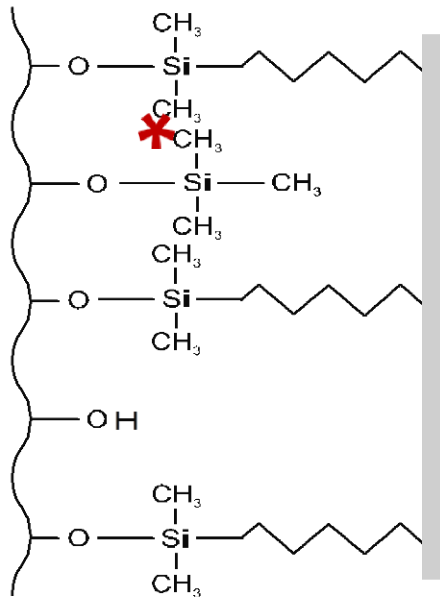

StableBond

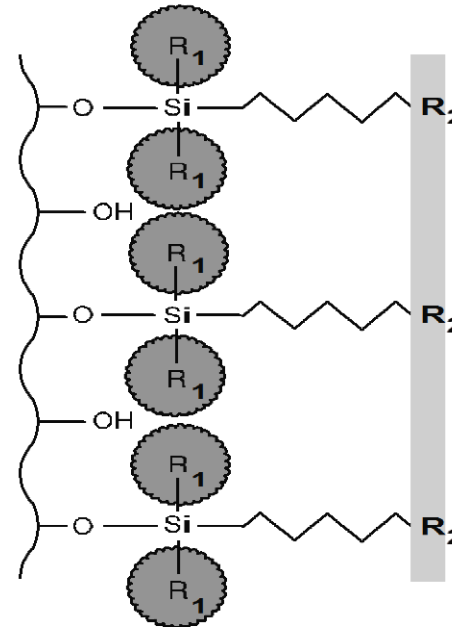

Operational Conditions

Mobile Phase Effects on Column Life

Bonded-Phase Hydrolysis Rate Increases With Temperature

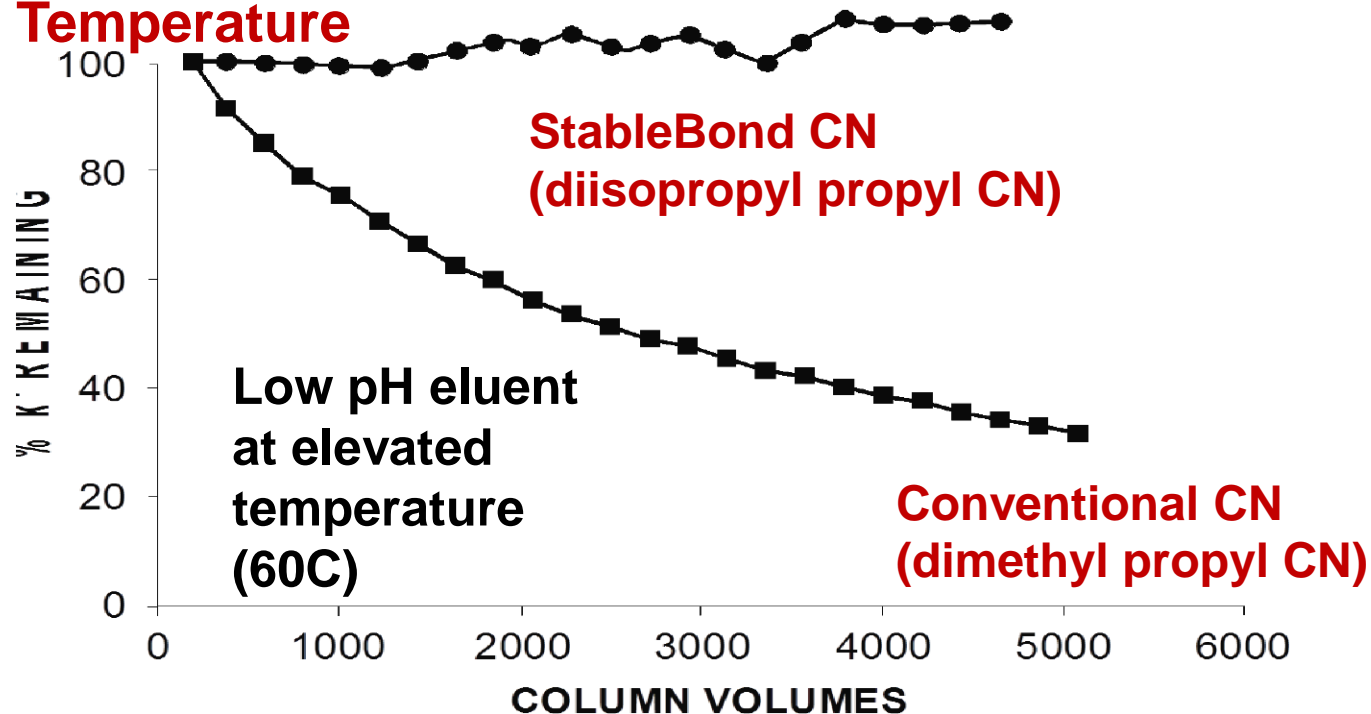

Column Lifetime with High pH Methods

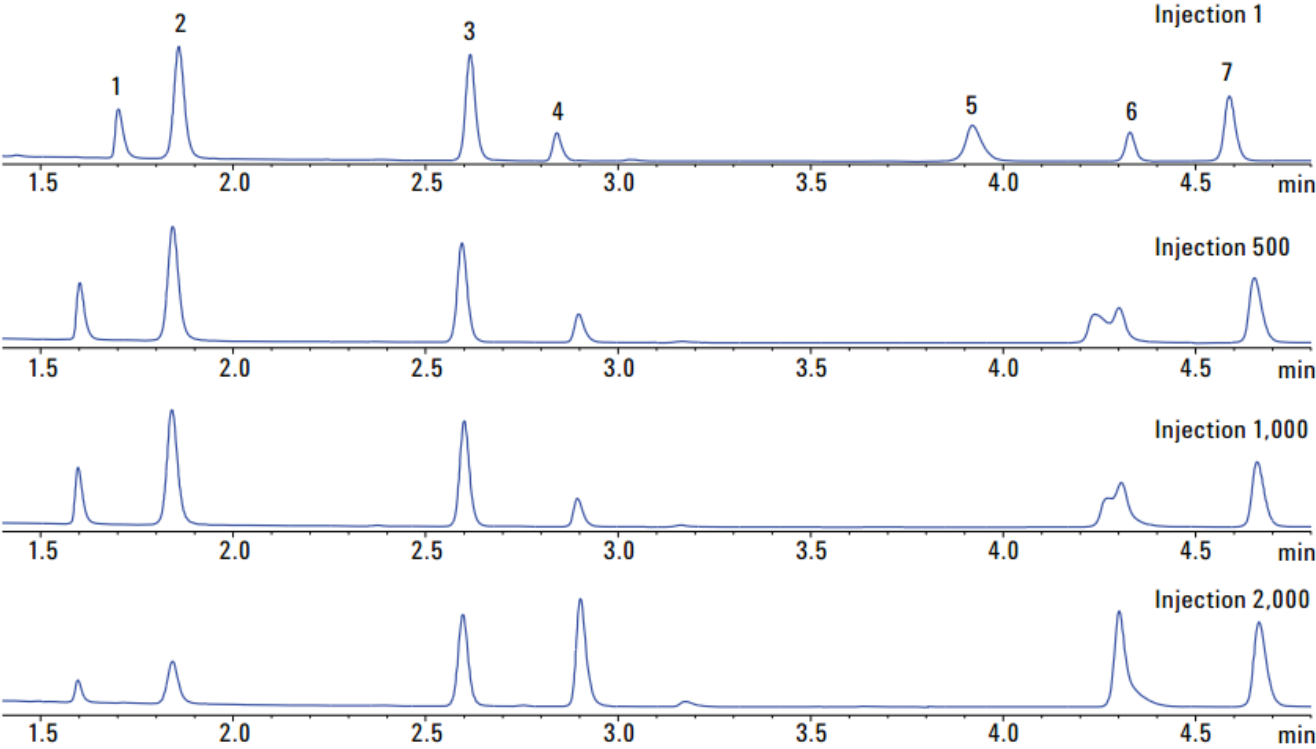

- Peak ID**
- 1. Methyl salicylate
 - 2. 4-Chlorocinnamic acid
 - 3. Acetophenone
 - 4. Quinine
 - 5. Nortriptyline
 - 6. Heptanophenone
 - 7. Amitriptyline

Conditions

Column: Other brand, 2.1 x 50 mm, 3 μm

Eluent: A) 10 mM ammonium bicarbonate adjusted to pH 10.0 in water
 B) acetonitrile

Flow rate: 0.4 mL/min

Gradient:

Time (min)	%B
0	5
5	95
5.1	5

Total run time: 7 min

Other brand column on an ammonium bicarbonate gradient at pH 10.

Column Lifetime with HPH-C18

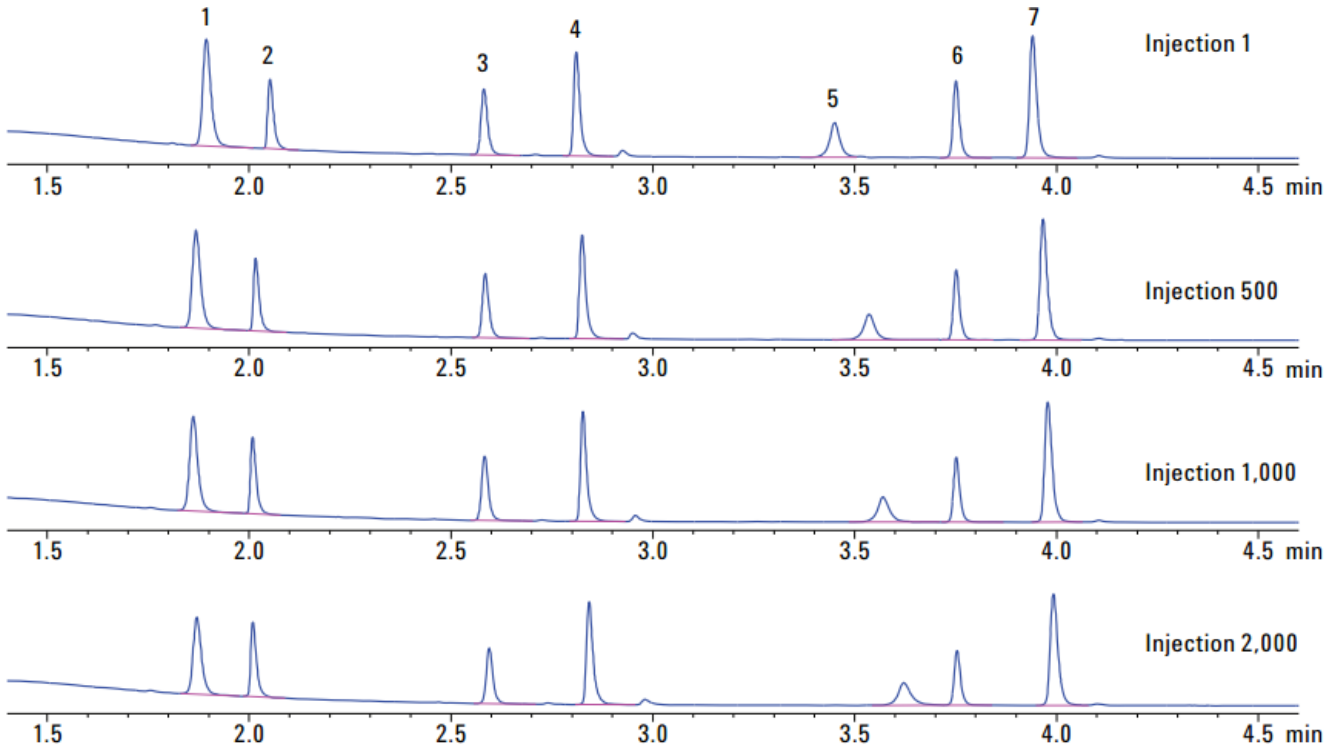

- Peak ID**
- 1. Methyl salicylate
 - 2. 4-Chlorocinnamic acid
 - 3. Acetophenone
 - 4. Quinine
 - 5. Nortriptyline
 - 6. Heptanophenone
 - 7. Amitriptyline

Conditions

Column: Agilent Poroshell 120 HPH-C18, 2.1 × 50 mm, 2.7 μm
 Eluent: A) 10 mM ammonium bicarbonate adjusted to pH 10.0 in water
 B) acetonitrile
 Flow rate: 0.4 mL/min
 Gradient:

Time (min)	%B
0	5
5	95
5.1	5

 Total run time: 7 min

Peak Tailing from Column Contamination (CRUD)

Column: StableBond SB-C8, 4.6 x 250 mm, 5 μ m Mobile Phase: 20% H₂O : 80% MeOH Flow Rate: 1.0 mL/min
 Temperature: R.T. Detection: UV 254 nm Sample: 1. Uracil 2. Phenol 3. 4-Chloronitrobenzene 4. Toluene

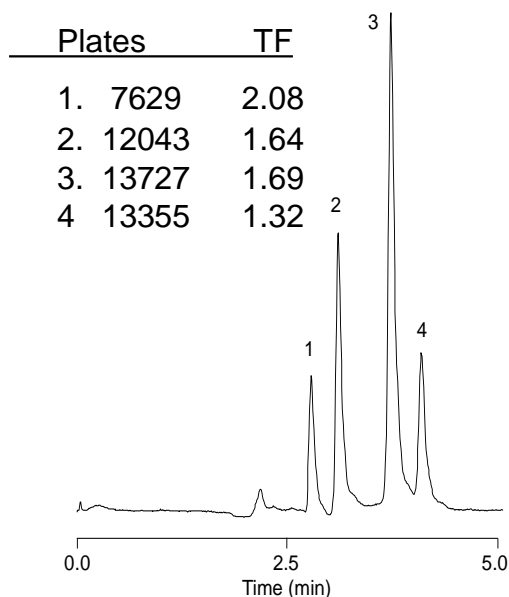

QC test forward direction

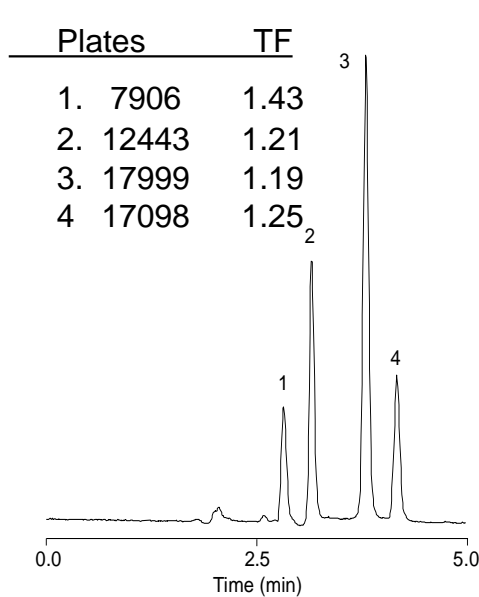

QC test reverse direction

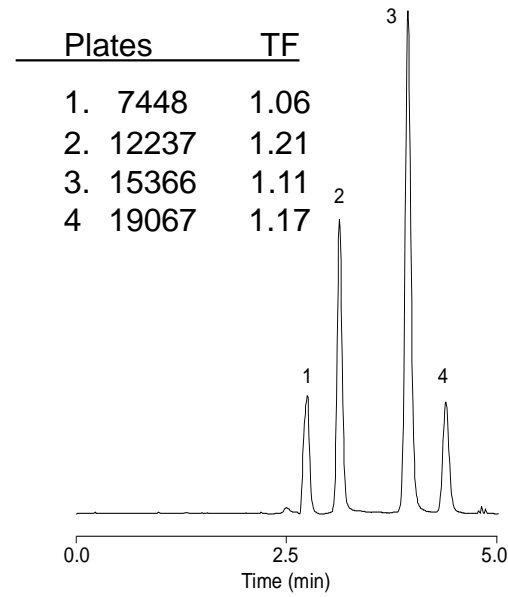

QC test after cleaning
100% IPA, 35°C

- Good column hygiene can extend the life of your column
 - Column cleaning procedure (see appendix)

Preventing Column Pressure Problems



1. Filter mobile phase:
 - filter non-HPLC grade solvents
 - filter buffer solutions
 - Install an in-line filter between auto-sampler and column (removes pump seal debris, injector rotor debris, and sample particulates). Use 2 μm frit for 3.5 μm /5 μm columns, use 0.5 μm frit for 1.8 μm /2.7 μm columns
2. Filter all samples and standards
3. Perform sample clean-up (i.e. SPE, LLE) on dirty samples.
4. Appropriate column flushing – flush buffers from entire system with water/organic mobile phase
5. Replace buffers every 24-48 hours, never add to the bottle, always use a new one



Guard Columns

What They Do

- ✓ Increase total “column length”
 - Increase retention
 - $(tR_T = (L_{col} + L_{gcol}) / (L_{col}) \times tR_{Col})$
 - Also - t_0 , w , P , N and R_s
- ✓ Should increase efficiency
- ✓ Provide protection to the analytical column

What They Don't Do

- ✓ Replace good sample clean-up
 - ✓ Replace column hygiene
- Not a “*magic device*”

- Any device in the flow path (guard column, filter, switching valve, detector, etc.) can adversely affect your chromatography
- To avoid a potential pitfall with your guard column
 - Test clean sample or standard with and without guard column in flow path
 - Chromatography should be equivalent

“*First, do no harm*”

Lot-to-Lot Comparison of 5 Lots Poroshell 120 EC-C18

2010



2012

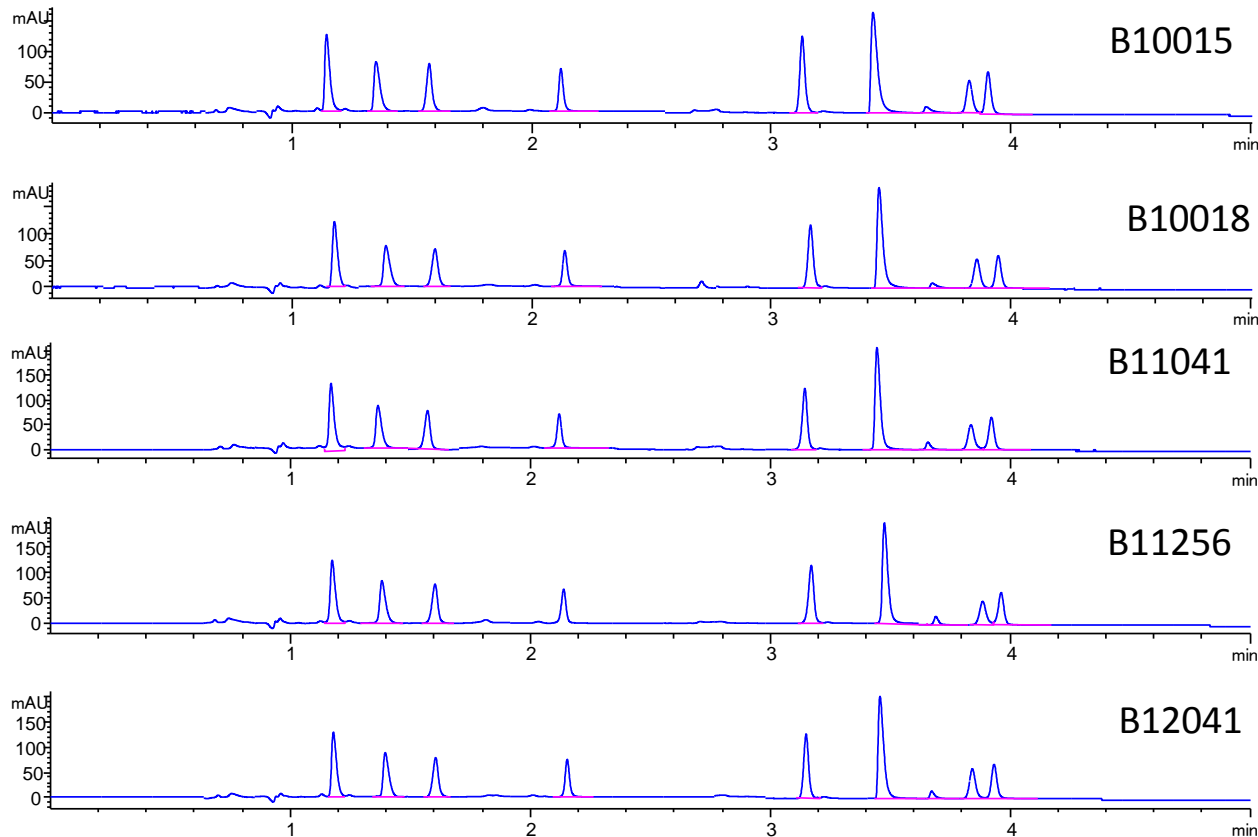

A 20 mM Ammonium Acetate pH 4.80 adjusted with 20 mM Acetic Acid B: Acetonitrile, 30 C, Sig= 230 nm, 4: ref 360,100
0.638 mL/min 10% to 40% B over 4 min, 3 x100 mm Poroshell 120 EC-C18
2ul Ascorbic acid, acesulfane K, saccharin, caffeine, aspartame, sorbic acid, quinine, dehydroacetic acid

**Agilent Poroshell 120 Columns for HPLC and UHPLC™,
March 15, 2013, Pub. No. 5990-5951EN; Brochure**

Lot-to-Lot Selectivity Change Related to pH Choice

pH 4.5 - Lot 1

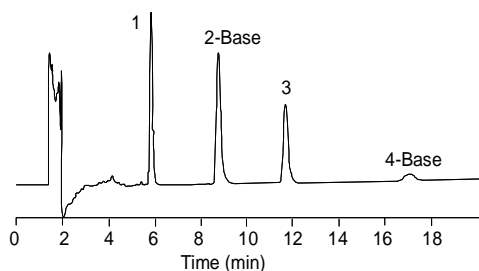

pH 3.0 - Lot 1

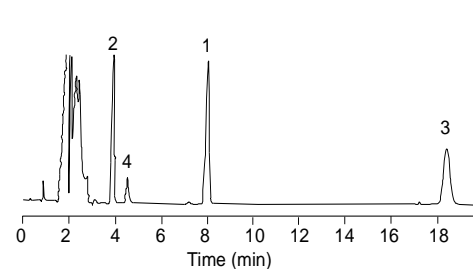

pH 4.5 - Lot 2

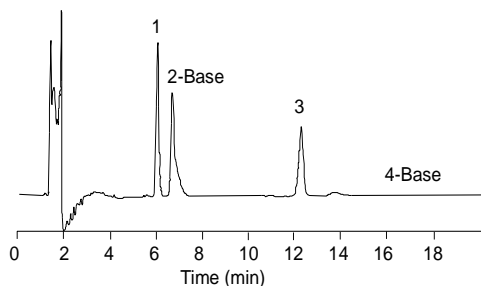

pH 3.0 - Lot 2

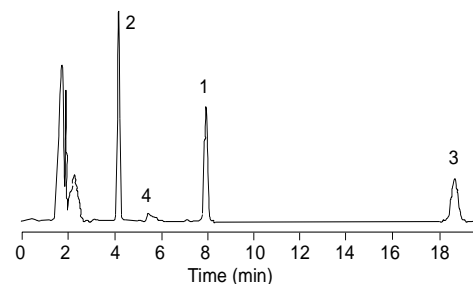

- pH 4.5 - selectivity change from lot-to-lot for basic compounds
- pH 3.0 - no selectivity change from lot-to-lot

➤ For Method Ruggedness

- Test 3 different column lots
- Compare R_s for the 3 lots
 - If ΔR_s is too large, modify method

Method Validation Kits

Agilent ZORBAX Rapid Resolution High Definition (RRHD) Method Validation Kits											
Size (mm)	Particle Size (µm)	Eclipse Plus C18	Eclipse Plus C8	Eclipse XDB-C18	Extend-C18	Eclipse Plus Phenyl-Hexyl	Bonus-RP	SB-C18	SB-C8	SB-Phenyl	SB-Aq
3.0 x 150	1.8	959759-302K	959759-306K	981759-302K				859700-302K	859700-306K		
3.0 x 100	1.8	959758-302K	959758-306K	981758-302K	758700-302K	959758-312K		858700-302K	858700-306K	858700-312K	858700-314K
3.0 x 50	1.8	959757-302K	959757-306K	981757-302K	757700-302K	959757-312K		857700-302K	857700-306K	857700-312K	857700-314K
2.1 x 150	1.8	959759-902K	959759-906K	981759-902K	759700-902K	959759-912K	859768-901K	859700-902K	859700-906K	859700-912K	859700-914K
2.1 x 100	1.8	959758-902K	959758-906K	981758-902K	758700-902K	959758-912K	858768-901K	858700-902K	858700-906K	858700-912K	858700-914K
2.1 x 50	1.8	959757-902K	959757-906K	981757-902K	757700-902K	959757-912K	857768-901K	857700-902K	857700-906K	857700-912K	857700-914K

Agilent ZORBAX Method Validation Kits													
Size (mm)	Particle Size (µm)	Eclipse Plus C18	Eclipse Plus C8	Eclipse XDB-C18	Eclipse XDB-C8	Extend-C18	Eclipse Plus Phenyl-Hexyl	Bonus-RP	SB-Aq	SB-C18	SB-C8	SB-Phenyl	
4.6 x 250	5	959990-902K	959990-906K	990967-902K	990967-906K	770450-902K	959990-912K	880668-901K	880975-914K	880975-902K	880975-906K	880975-912K	
4.6 x 150	5	959993-902K	959993-906K	993967-902K	993967-906K	773450-902K		883668-901K	883975-914K	883975-902K	883975-906K	883975-912K	
3.0 x 150	5	959993-302K											
4.6 x 250	3.5										884950-567K		
4.6 x 150	3.5	959963-902K	959963-906K	963967-902K	963967-906K	763953-902K	959963-912K	863668-901K	863953-914K	863953-902K	863953-906K	863953-912K	
4.6 x 100	3.5	959961-902K	959961-906K	961967-902K	961967-906K	764953-902K	959961-912K	864668-901K	861953-914K	861953-902K	861953-906K	861953-912K	
4.6 x 50	3.5	959943-902K	959943-906K	935967-902K	935967-906K	735953-902K	959943-912K	835668-901K	835975-914K	835975-902K	835975-906K	835975-912K	
4.6 x 150	1.8	959994-902K											
4.6 x 100	1.8	959964-902K	959964-906K	928975-902K	928975-906K	728975-902K	959964-912K	828668-901K	828975-914K	828975-902K	828975-906K	828975-912K	
4.6 x 50	1.8	959941-902K	959941-906K	927975-902K	927975-906K	727975-902K	959941-912K	827668-901K	827975-914K	827975-902K	827975-906K	827975-912K	
3.0 x 100	1.8					928975-306K		828668-301K					
3.0 x 50	1.8					927975-306K		827668-301K					
2.1 x 100	1.8					928700-906K							
2.1 x 50	1.8					927700-906K							

Agilent Poroshell 120 Method Validation Kits								
Size (mm)	Particle Size (µm)	EC-C18	EC-C8	Phenyl-Hexyl	SB-C18	SB-C8	SB-Aq	Bonus-RP
4.6 x 150	2.7	693975-902K	693975-906K	693975-912K	683975-902K	683975-906K	683975-914K	693968-901K
4.6 x 100	2.7	695975-902K	695975-906K	695975-912K	685975-902K	685975-906K	685975-914K	695968-901K
4.6 x 50	2.7	699975-902K	699975-906K	699975-912K	689975-902K	689975-906K	689975-914K	699968-901K
3.0 x 150	2.7	693975-302K	693975-306K	693975-312K	683975-302K	683975-306K	683975-314K	693968-301K
3.0 x 100	2.7	695975-302K	695975-306K	695975-312K	685975-302K	685975-306K	685975-314K	695968-301K
3.0 x 50	2.7	699975-302K	699975-306K	699975-312K	689975-302K	689975-306K	689975-314K	699968-301K
2.1 x 150	2.7	693775-902K	693775-906K	693775-912K	683775-902K	683775-906K	683775-914K	693768-901K
2.1 x 100	2.7	695775-902K	695775-906K	695775-912K	685775-902K	685775-906K	685775-914K	695768-901K
2.1 x 50	2.7	699775-902K	699775-906K	699775-912K	689775-902K	689775-906K	689775-914K	699768-901K

Method Conditions

➤ Mobile phase

- What's in your mobile phase and why
- Don't believe everything you read; Focus of paper may not be chromatography
- Microbial growth
- Baseline
 - Drift
 - Additives, e.g., TFA
 - Detector, e.g., RI
 - Problems, http://www.chem.agilent.com/Library/Support/Documents/Baseline_problems.pdf
- Mobile phase prep
- Ghost Peaks
 - Sample
 - Mobile phase components; H₂O, solvent, additives

➤ pH

- High
- Low

➤ Temperature

➤ Injection problems

Microbial Growth

➤ Potential problems

- Increased system pressure or pressure fluctuations
- Increased column pressure, premature column failure
- Can mimic application problems
- Gradient inaccuracies
- Ghost peaks
- Difficult to remove if gets in degasser and rest of system

➤ Prevent and/or Reduce Microbial Growth

- Use freshly prepared mobile phase
- Filter
- Do not leave mobile phase in instrument for days without flow
- Always discard “old” mobile phase
 - Do not add fresh mobile phase to old
- Use an amber solvent bottle for aqueous mobile phase
- If possible, can add
 - 5% organic added to water can be used to reduce bacterial growth
 - Few mg/l sodium azide

- To avoid contaminating your system and column, prevent microbial growth
 - Check your instrument manual for guidelines

Baseline Drift

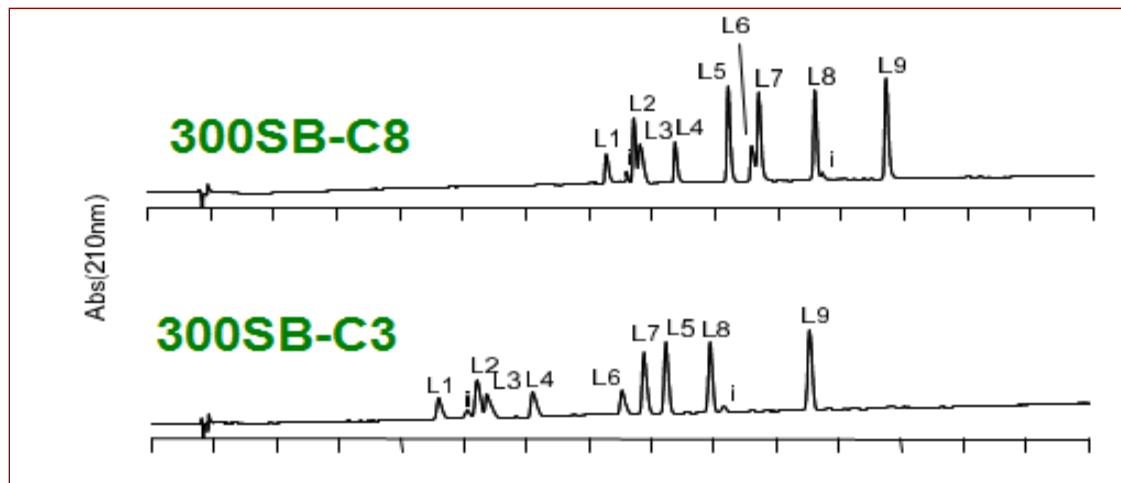

Conditions:

Columns: ZORBAX 300SB, 4.6 x 150 mm, 5 μ m

Mobile Phase: Gradient, 0 - 26% B in 30min.

A = 0.1% TFA in Water

B = 0.1% TFA in Acetonitrile

Temperature: 40°C

Sample: 2 μ g of each peptide

Flow Rate: 1.0 mL / min.

Detection: UV-210nm

➤ Know the UV Cutoff of your mobile phase components

Mobile Phase Preparation

- HPLC grade or better
- Buffer preparation procedure
 - Be consistent
 - Document the process
- Volume % of solvents can depend on preparation

Specified volume ACN added to a 1 L volumetric and made to volume with H₂O

≠

Specified volume H₂O added to a 1 L volumetric and made to volume with ACN

≠

500 ml H₂O added to 500 ml ACN

- Small changes in mobile phase strength can have a large effect on retention
- To avoid this pitfall, be consistent and document your procedure

Mobile Phase Preparation

Effect on Chromatography

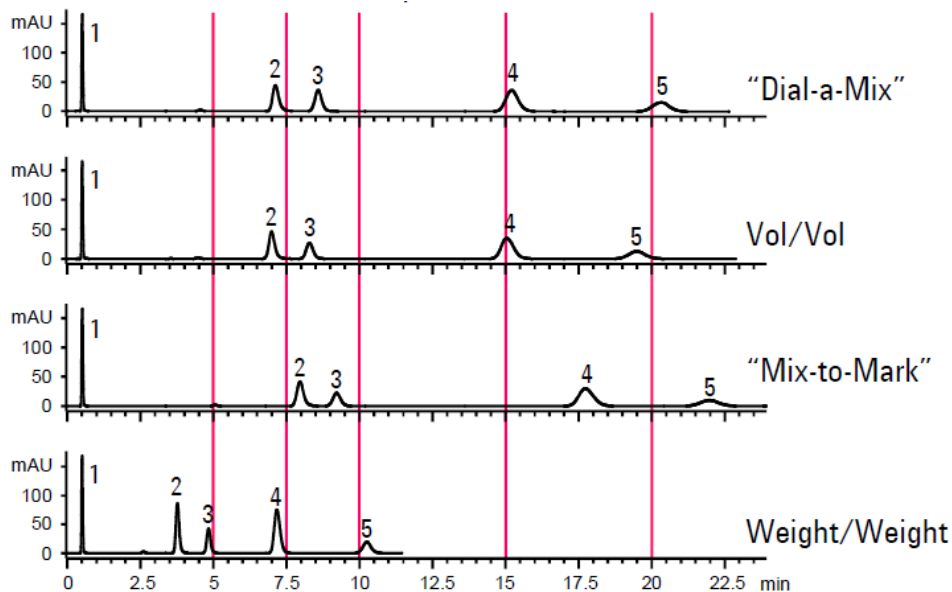

HPLC System: Agilent 1100 with quaternary pump
Column: ZORBAX Eclipse XDB-C8 Rapid-Resolution (3.5 μ m), 4.6 x 50 mm
Agilent Part No. 935967-906
Mobile Phases: Dial-a-Mix= A: water B: MeOH, pump 50% B
Vol/Vol=250 mL water + 250 mL MeOH, pump 100%
Mix-to-Mark = 250 mL MeOH, fill to 500 mL with water, pump 100%
Premixed (w/w) = 200 g MeOH + 200 g water, pump 100%
Detection: UV 254 nm
Flow: 1 mL/ min.
Temperature: ambient

1. Uracil
2. Butylparaben
3. Naphthalene
4. Dipropylphthalate
5. Acenaphthene

- Method used to prepare MP can significantly affect the elution pattern
- To avoid this potential pitfall
 - Be consistent
 - w/w is more accurate than v/v

Effect of Mobile Phase Preparation on Chromatography,
Pub. No. 5988-6476EN

Ghost Peaks

Where Do They Come From

- Organic
- Additives
 - TFA
 - Salts
- H₂O
- Sample
- Other

Acetonitrile Comparison

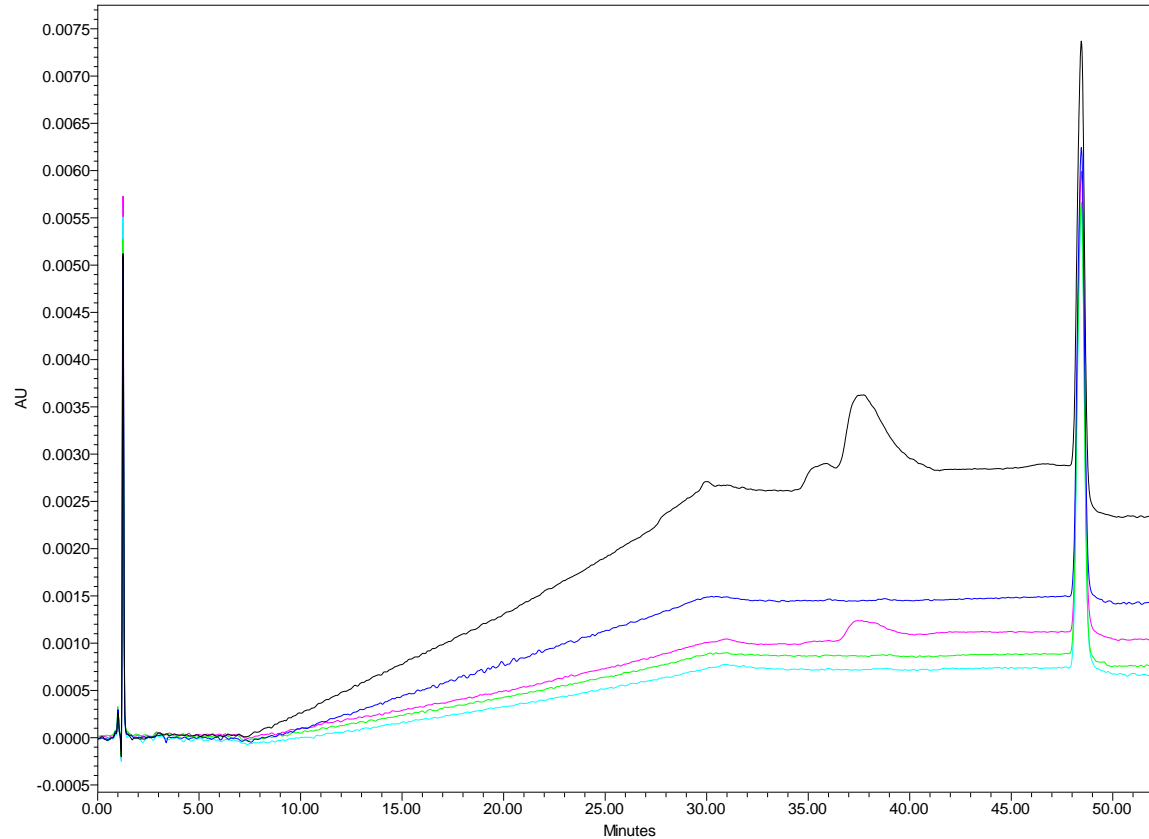

Multiple suppliers and lots of ACN tested

➤ Solvent - quality and consistency

Ghost Peaks

The LC system was equilibrated at starting conditions for 30min, then a gradient run was made. Impurities were trapped and eluted out with the gradient.

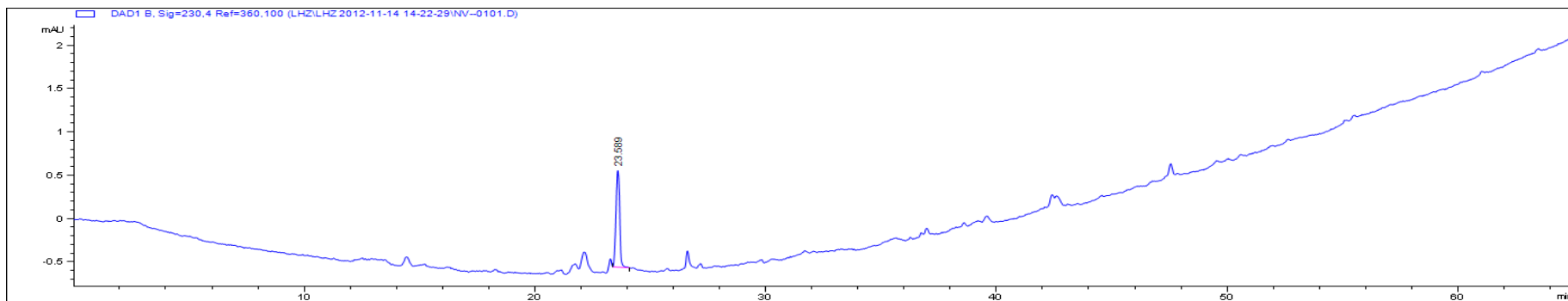

When an injection is made with minimal equilibration, a much cleaner baseline was observed.

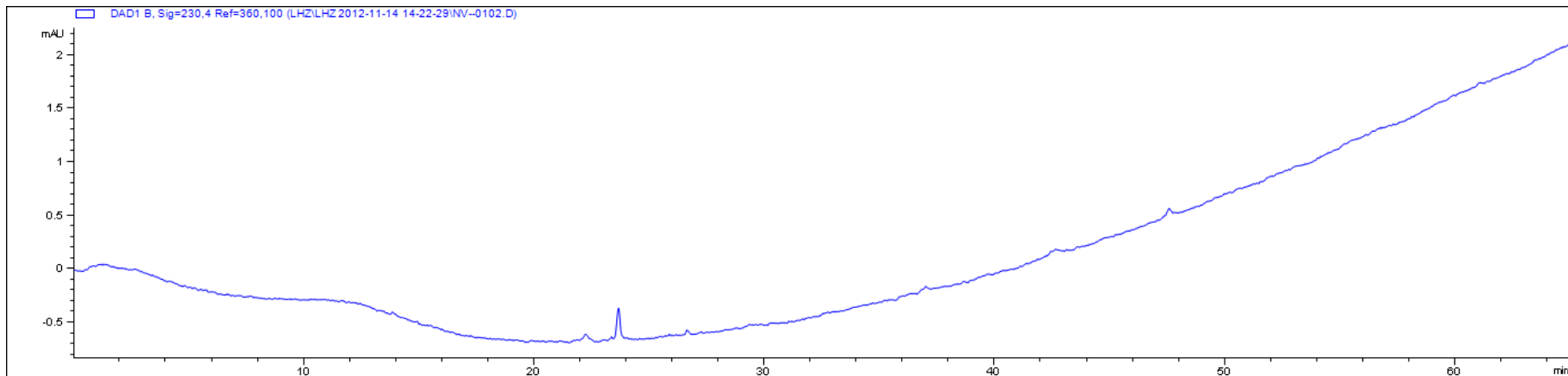

Broad Peaks

Unknown “Phantom” Peaks

Column: Extend-C18, 4.6 x 150 mm, 5 μ m Mobile Phase: 40% 10 mM TEA, pH 11 : 60% MeOH Flow Rate: 1.0 mL/min
Temperature: R.T. Detection: UV 254 Sample: 1. Maleate 2. Pseudoephedrine 3. Chlorpheniramine

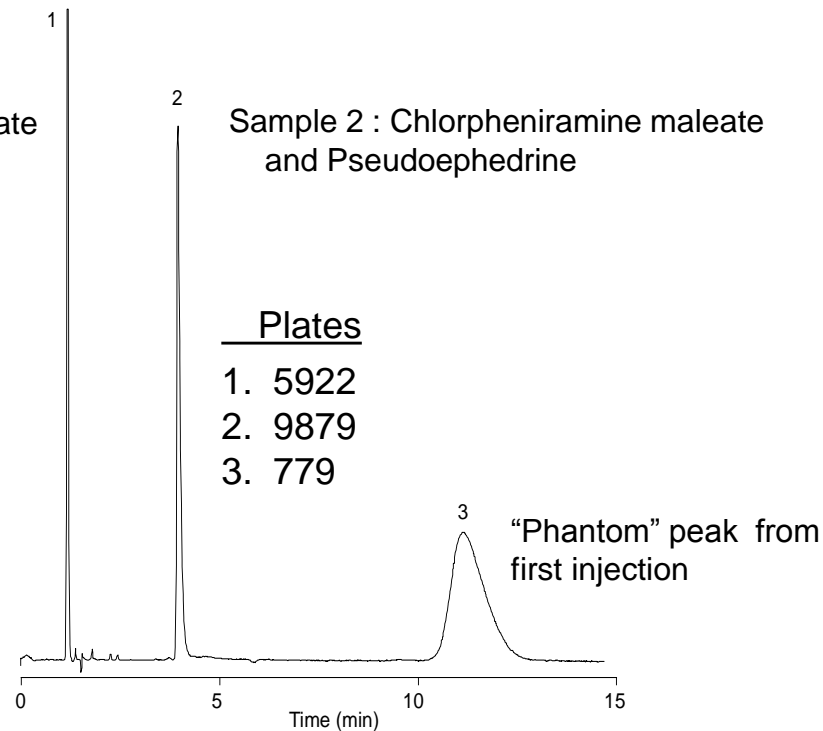
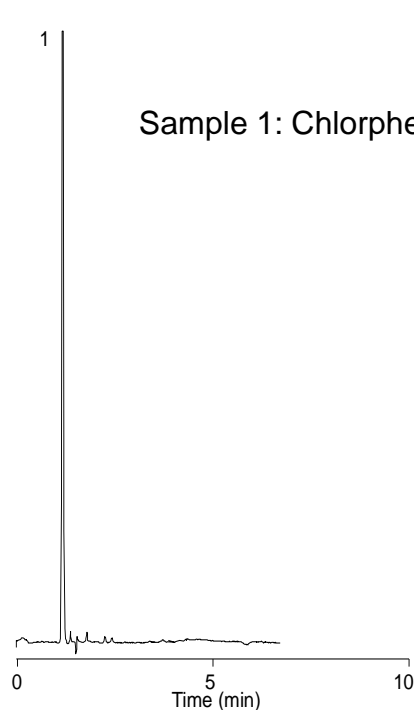

- Extremely low plates are an indication of an extremely late eluting peak from the preceding run
- Disproportionally broad peak can be an indicator too.
- **Make sure everything has come off the column**

Choosing the Best Syringe Filters

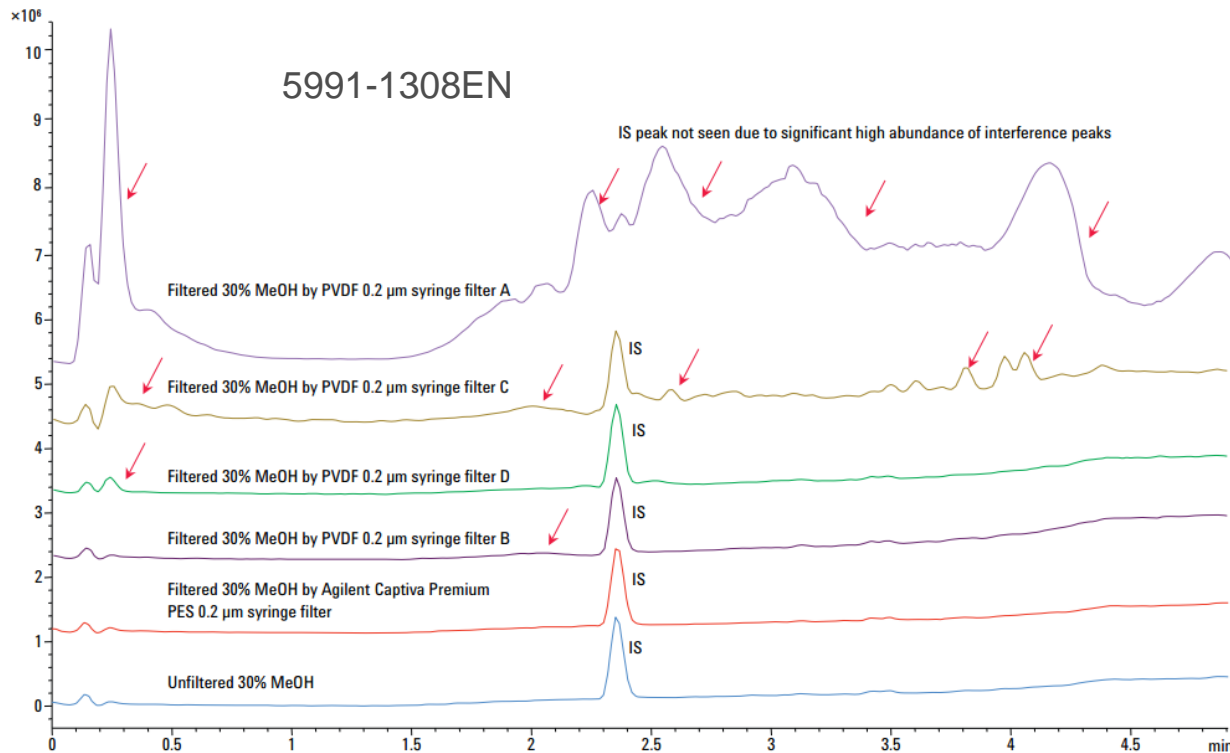

Filter cleanliness comparison of the Agilent Captiva Premium PES syringe filter with non-Agilent PVDF syringe filters using LC/MS under positive mode.

UHPLC:	Agilent 1290 Infinity LC System
Column:	Agilent ZORBAX RRHD Eclipse Plus C18, 2.1 × 50 mm, 1.8 μm (p/n 959757-902)
Mobile phases:	A: H ₂ O + 0.01% formic acid (FA) B: Acetonitrile + 0.01% FA
Flow rate:	0.5 mL/min, gradient
Total run time:	5 min plus 1 min post run
Gradient:	Hold at 30% B for 1 min, then ramped to 90% B in 3 min, and hold at 90% B for 1 min
Injection volume:	8 μL
Internal standard:	50 μg/mL Naproxin
MS:	Agilent 6150 Single Quadrupole LC/MS System
Source:	ESI with Agilent Jet Stream Technology (AJS-ES)
Capillary voltage:	4,000 V
Nozzle voltage:	2,000 V
Drying gas flow:	12 L/min
Drying gas temp:	250 °C
Nebulizer pressure:	35 psig
Sheath gas flow:	3.0 L/min
Sheath gas temp:	150 °C
Mass range:	100 – 1350 m/z
Fragmentor:	150 V (pos), 80 V (neg)

- When selecting a syringe filter, make sure it is appropriate for the sample
- **And make sure it does not add unwanted interferences**

<http://filtrationselectiontool.chem.agilent.com>

Captiva Filtration Selection Guide: 5991-1230EN

Method Conditions

➤ Mobile phase

- What's in your mobile phase and why
- Don't believe everything you read; Focus of paper may not be chromatography
- Microbial growth
- Baseline
 - Drift
 - Additives, e.g., TFA
 - Detector, e.g., RI
 - Problems, http://www.chem.agilent.com/Library/Support/Documents/Baseline_problems.pdf
- MP prep
- Ghost Peaks
 - Sample
 - Mobile phase components; H₂O, solvent, additives

➤ pH

- High
- Low

➤ Temperature

➤ Injection problems

- Sample solvent
- Injection volume

Change in Retention with pH for Ionizable Compounds is Compound-Dependent

More retention for non-charged analytes (i.e. acids at low pH and bases at high pH)

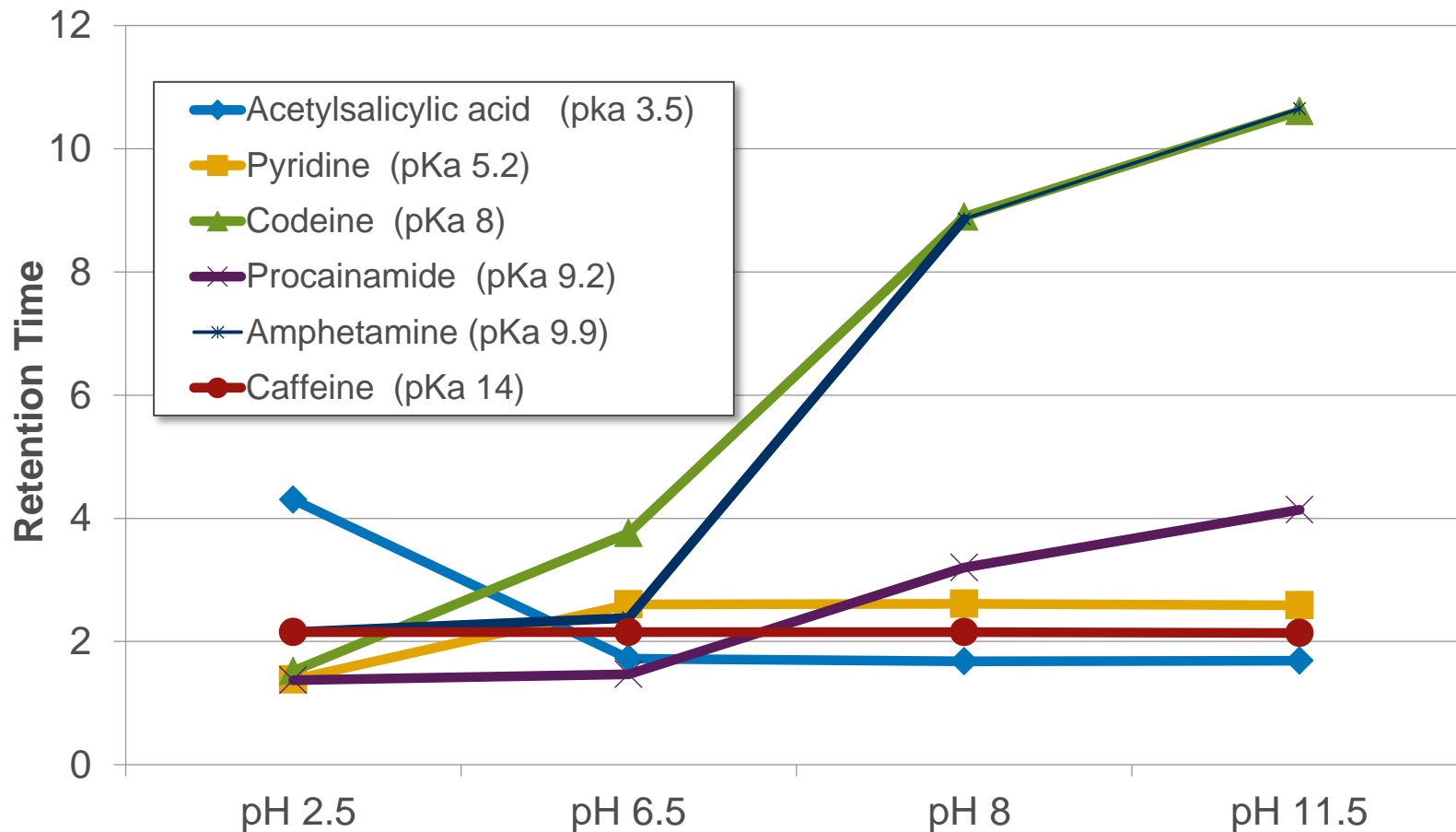

Mobile Phase: 45% MeOH, 55% 20 mM Phosphate Buffer

pH Can Affect Your Separation

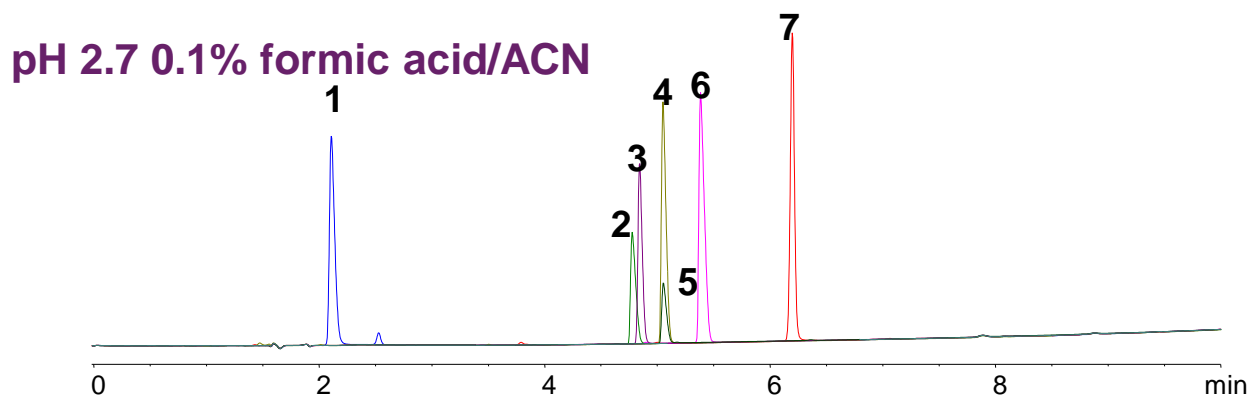

1. procainamide
2. buspirone
3. pioglitazone
4. eletriptan
5. dipyridamole
6. diltiazem,
7. furosemide

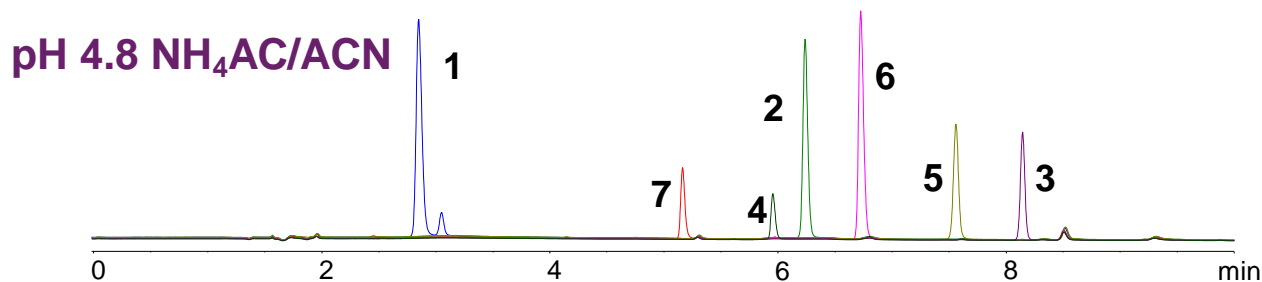

➤ Selectivity and resolution can change with pH

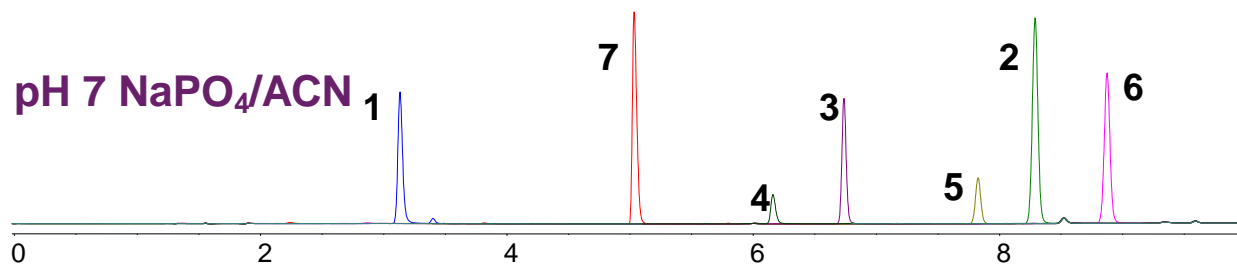

➤ Eclipse Plus can be used with many mobile phases and pH's

Conditions: Column: Eclipse Plus C18 4.6 x 100mm, 5um Gradient: 10 – 90% in 10 minutes Detection: UV 254 nm

Temperature

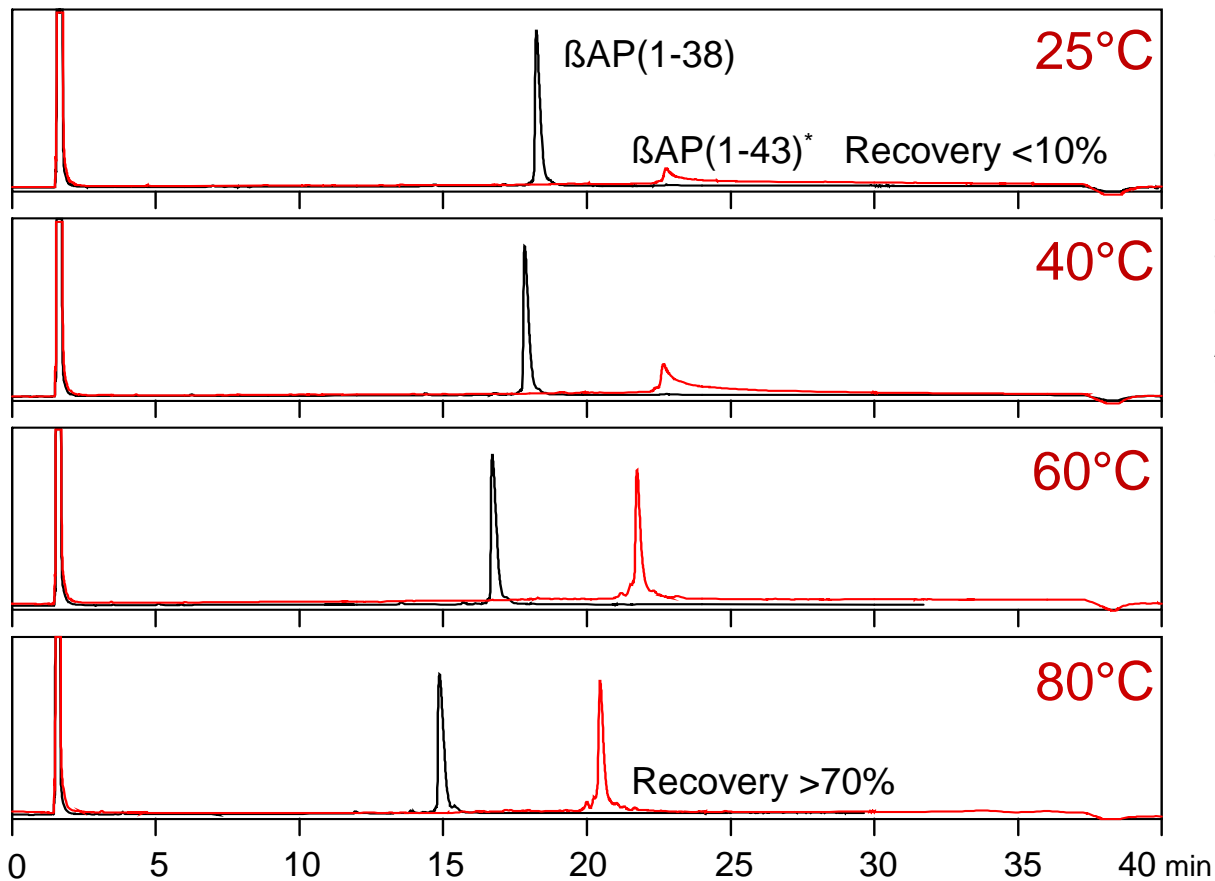

Column: ZORBAX 300 SB-C18, 4.6 x 150 mm

Sample: 10 μ l injection,
5 μ g peptide in 6M Urea/5% HOAc

Conditions: 1 ml/min
A=0.1%TFA in H₂O, B=0.09%TFA in ACN
Gradient: 20-45% B / 35 min

- Changes k^* and α^*
- Potentially Improves Resolution (R)

Sample

Consider the effects of your sample matrix

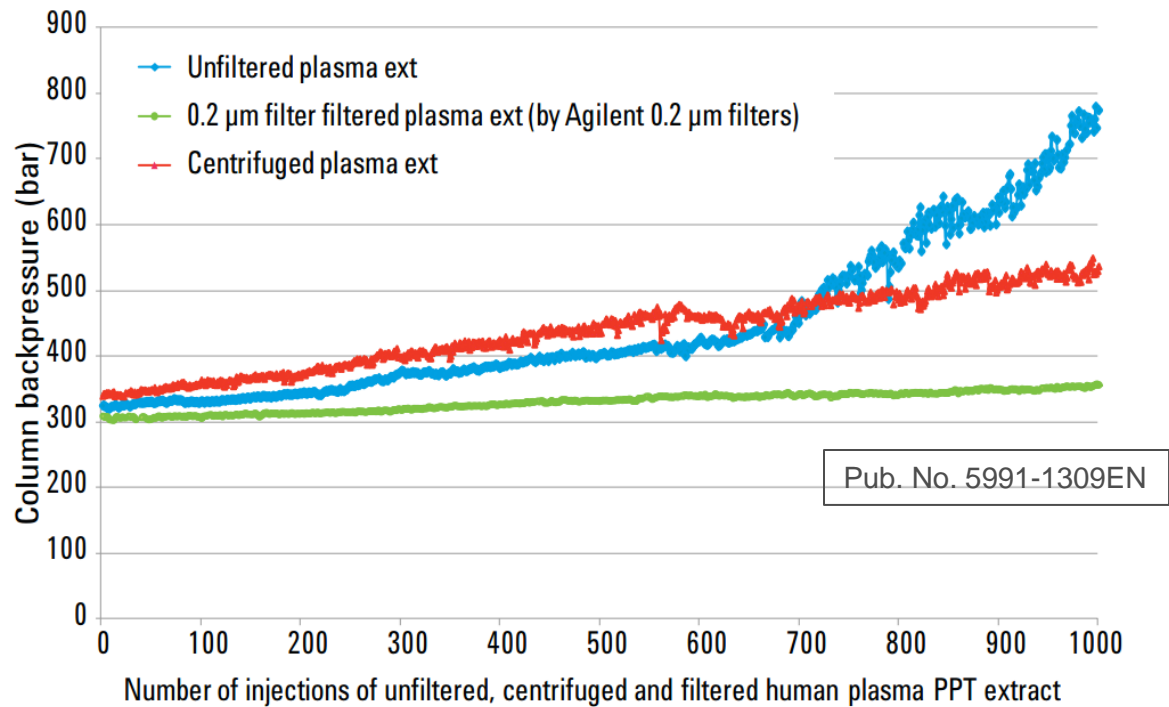

Unfiltered, centrifuged, and filtered plasma extracts
Zorbax RRHD Eclipse Plus C18, 2.1 x 50 mm, 1.8 µm column, PN 959757-902

- Column plugging is one of the most common sources of LC column failure
- Especially with sub-2 µm columns, sample particulates can easily plug the column inlet frit
- To help avoid this pitfall, use an appropriate 0.2 µm filter with all samples prior to injection

<http://filtrationselectiontool.chem.agilent.com>

Captiva Filtration Selection Guide: 5991-1230EN

Split Peaks

Injection Solvent Effects

Column: StableBond SB-C8, 4.6 x 150 mm, 5 mm Mobile Phase: 82% H₂O : 18% ACN
Injection Volume: 30 μ L Sample: 1. Caffeine 2. Salicylamide

A. Injection Solvent
100% Acetonitrile

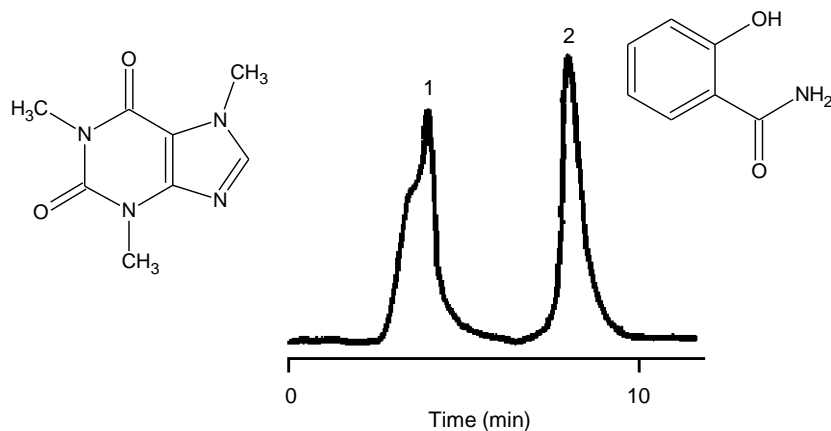

B. Injection Solvent
Mobile Phase

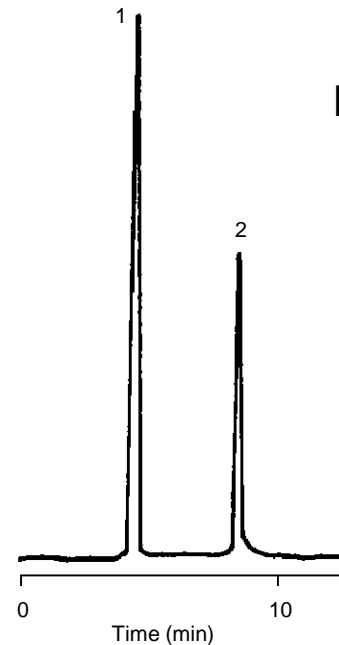

Injection Solvent Effects

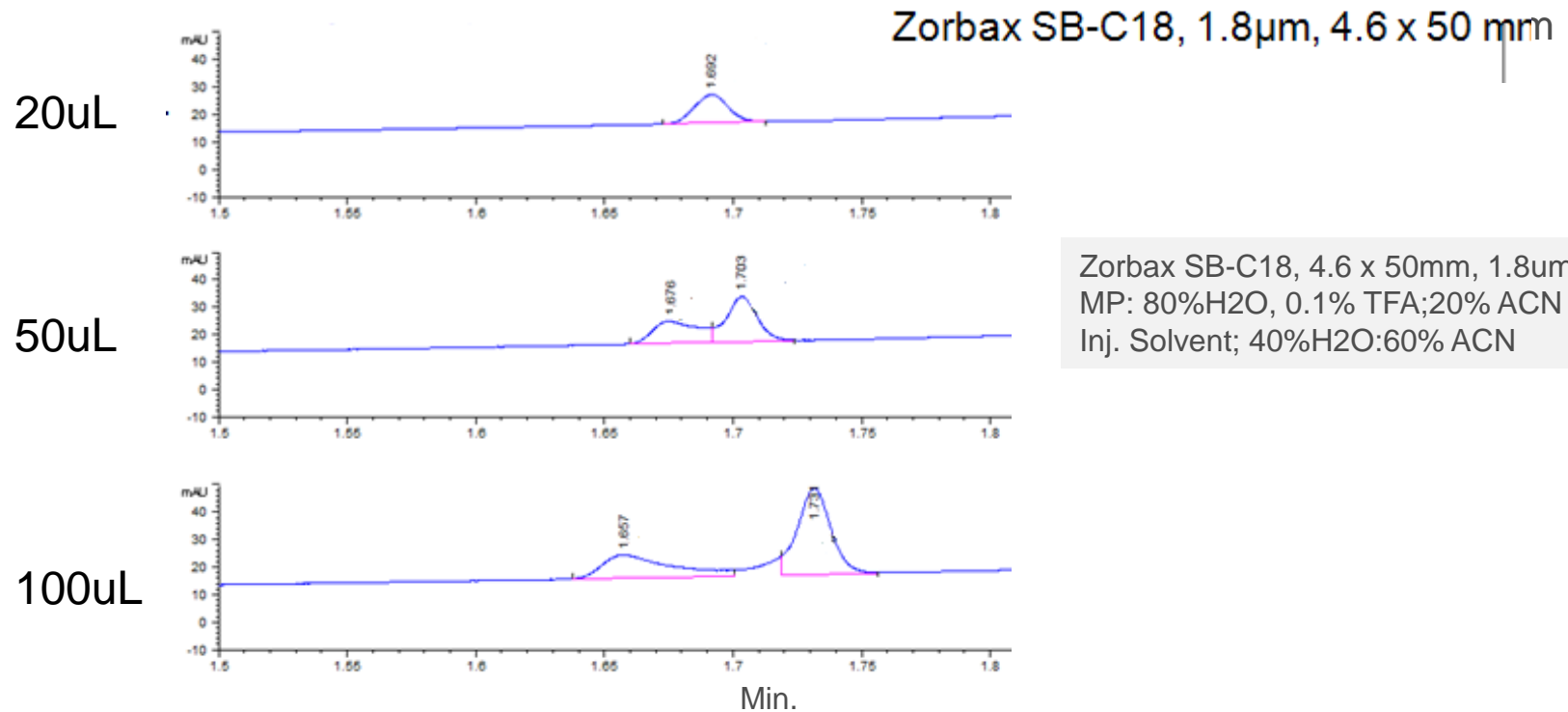

➤ Peak splitting is often observed when injecting a large volume of sample in a solvent that is stronger than the mobile phase

➤ To avoid this pitfall

- When injecting a sample in strong solvent, limit the size of the injection
- Inject the sample in a solvent that is no stronger than the starting conditions for the method

Conclusion

These are just a few of the potential pitfalls which we see fairly regularly.

Have you encountered other pitfalls or do you have an example of one we talked about today? If you have one you'd like to share for a future pitfalls talk, please send it to lc-column-support@agilent.com.

Thank you!

Additional slides

Temperature - Effect on Sample

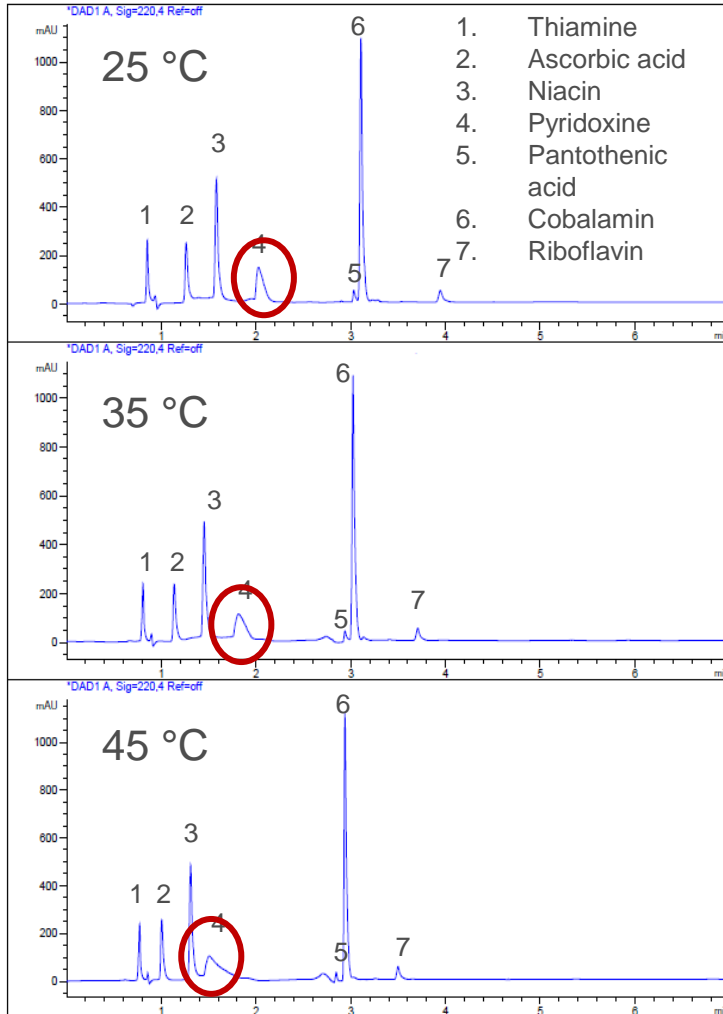

Columns: Poroshell 120 EC-C18, 2.7 μ m, 3.0 x 100 mm
Mobile Phase: A=10 mM ammonium formate, pH 3.8
B = methanol
Gradient: 0 min, 1% B; 0.53 min, 12% B; 0.55 min, 30% B; 3.8 min, 30% B
Flow Rate: 0.8 mL / min.

- Generally, increasing temperature improves peak shape
- But depending on the conditions, the unexpected can occur
- To avoid temperature related pitfalls, it is a good idea to try several different temperatures to see how it affects peak shape and retention
- Remember room temperature is not the same in every room!

Quick Connect fittings use special capillaries



Quick Connect fitting requires capillary with spring and a PEEK component



Quick Turn fitting needs capillary with long socket due to its internal spring action

- A wide variety of capillary lengths and inner diameters are available to meet HPLC and UHPLC needs
- Capillaries and ferrules are completely user replaceable

Replacing capillaries and ferrules

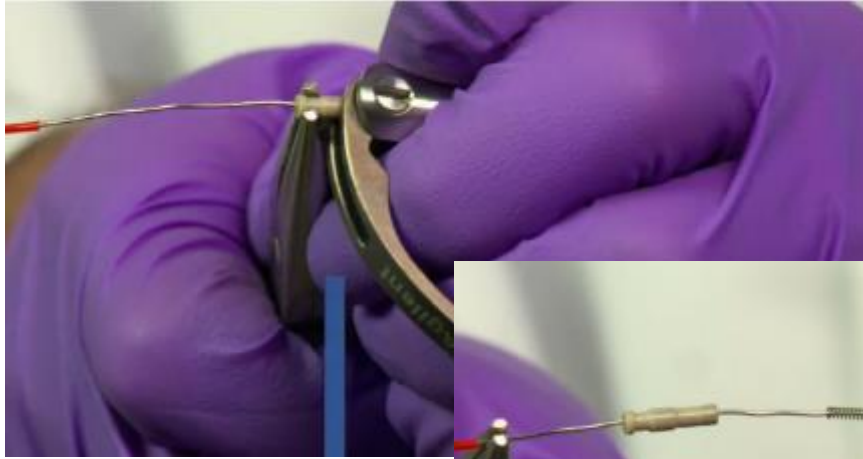

If the capillary is damaged, or another dimension is needed, just use a plier to remove the capillary and insert a new one.



The ferrules can also be replaced; just use pliers to remove the ferrule and insert a new one.



Separation Ruggedness

Buffer Preparation

1. Dissolve salt in organic-free water in 1- or 2-L beaker. Use appropriate volume to leave room for pH adjustment solution. Equilibrate solution to room temperature for maximum accuracy.
2. Calibrate pH meter. Use 2-level calibration and bracket desired pH. Use appropriate audit solution to monitor statistical control (for example, potassium hydrogen tartrate, saturated solution, pH = 3.56).
3. Adjust salt solution to desired pH. Minimize amount of time electrode spends in buffer solution (contamination). Avoid overshoot and readjustment (ionic strength differences can arise).
4. Transfer pH-adjusted buffer solution quantitatively to volumetric flask, dilute to volume, and mix.
5. Filter through 0.45 μm filter. Discard first 50 – 100 mL filtrate. Rinse solvent reservoir with small volume of filtrate and discard. Fill reservoir with remaining filtrate or prepare premix with organic modifier.
 - Agilent Solvent Filtration Kit, 250-mL reservoir, 1000-mL flask, p/n 3150-0577
 - Nylon filter membranes, 47 mm, 0.45 μm pore size, p/n 9301-0895

Using Buffers Successfully

Initial Column and System Equilibration

In an appropriate vessel, test highest % organic/buffer ratio to verify that buffer will not precipitate. With stirring, add organic to buffer first, not vice versa.

Equilibrate column with, in order:

- 100% organic modifier (if brand new)
- mobile phase minus buffer
- buffered mobile phase containing highest % organic modifier (gradient high end)
- buffered mobile phase containing lowest % organic modifier (gradient low end).

Inject standard or sample several times until RTs stable, or for gradient methods, precede former with 1 or 2 blank gradients.

Using Buffers Successfully

Shutdown State and Instrument Flushing

Shutdown State

Next day use—using same buffers

- Pump mobile phase very slowly (for example, 0.01 – 0.1 mL/min).

When flushing column or for longer term column storage

- Flush with 20/80 organic/water, then 80/20 organic/water or 100% organic.

Instrument flushing

Replace column with capillary tubing. Leave disconnected from detector.

Flush pumps with water, then connect capillary tubing to detector.

Inject water 2-3 times at maximum injection volume setting.

Flush all pumps with 100% organic for long term storage.

Injection Volumes for Different ID's

Column ID	Column Volume	Peak Volume, k=1	Typical Injection Volume	Typical Inj Vol Range
4.6 mm	1500 μL	148 μL	20 μL	5 – 50 μL
3.0 mm	640 μL	44 μL	10 μL	3 – 30 μL
2.1 mm	320 μL	22 μL	2 μL	0.5 – 15 μL
1.0 mm	70 μL	4 μL	0.5 μL	0.1 – 3 μL
0.5 mm	15 μL	1 μL	150 nL	40 – 500 nL
0.3 mm	6 μL	0.3 μL	50 nL	15 – 250 nL
0.1 mm	700 nL	32 nL	10 nL	1 – 10 nL
0.075 mm	400 nL	18 nL	2 nL	0.5 – 5 nL

Column length = 150 mm, N =13,000

~Column Volume = $3.14 \times (\text{Column ID}/2)^2 \times \text{Column Length} \times 0.60$

➤ Typical injection volume = 10 – 30% of peak volume of first eluting peak.