

# Avoiding Chromatography Heartbreak: Common LC Pitfalls



---

Rita Steed  
LC Columns Application Engineer  
February 28, 2017

---

# Avoiding Overview

## ➤ Instrument

- Connections
- Performance

## ➤ Column

- Characteristics
- Lifetime

## ➤ Method

- Mobile phase
- Temperature

## ➤ Sample

- Cleanup
- Injection



---

# Instrument Pitfalls

## ➤ Fittings

- Connections
  - Improper – Results in areas where the flow does not move smoothly

## ➤ Tubing

- ID, Length
- No random pieces

## ➤ Detector

- Flow cell
- Proper settings

# LC Connections



- Problems with improper connections
  - Source of leaks
  - **Mistaken for chromatography issues**
- Making connections can vary with skill/technique
- Different manufacturers supply different types of fittings

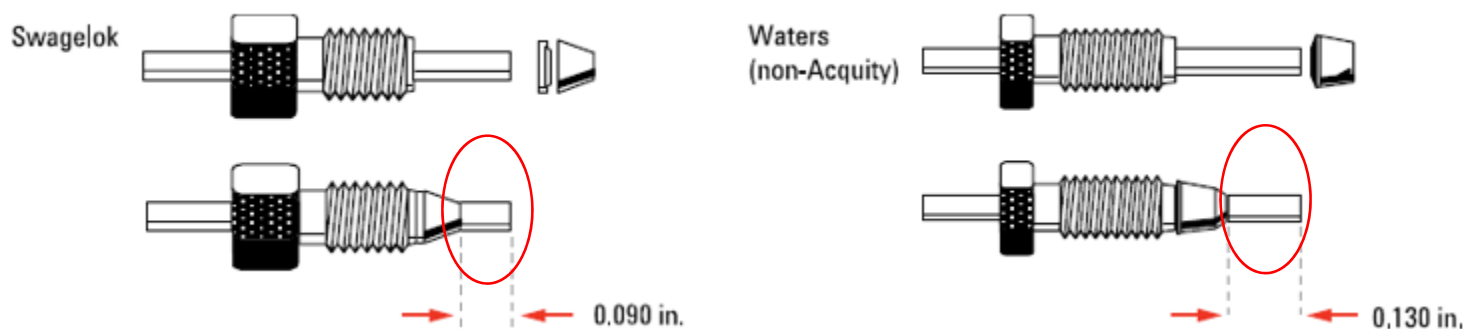

# Potential Fittings Issues

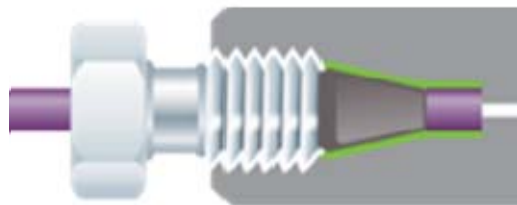

- Leak



- Peak shape problem



- No dead volume



# Poor Fitting Peak Tailing – Extra Column Effects

**Problem:**  
**All peaks tail**  
**(top chromatogram).**

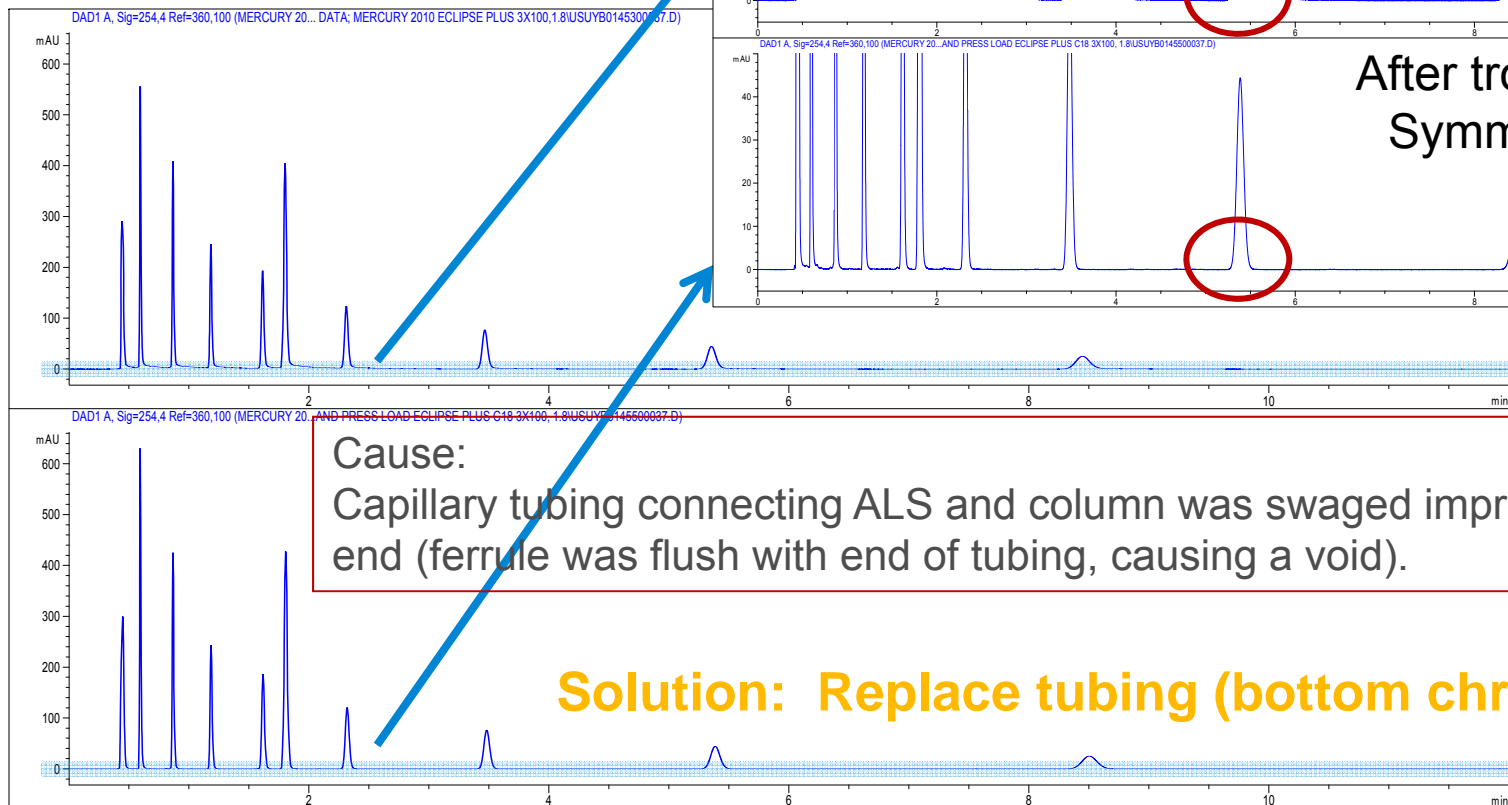
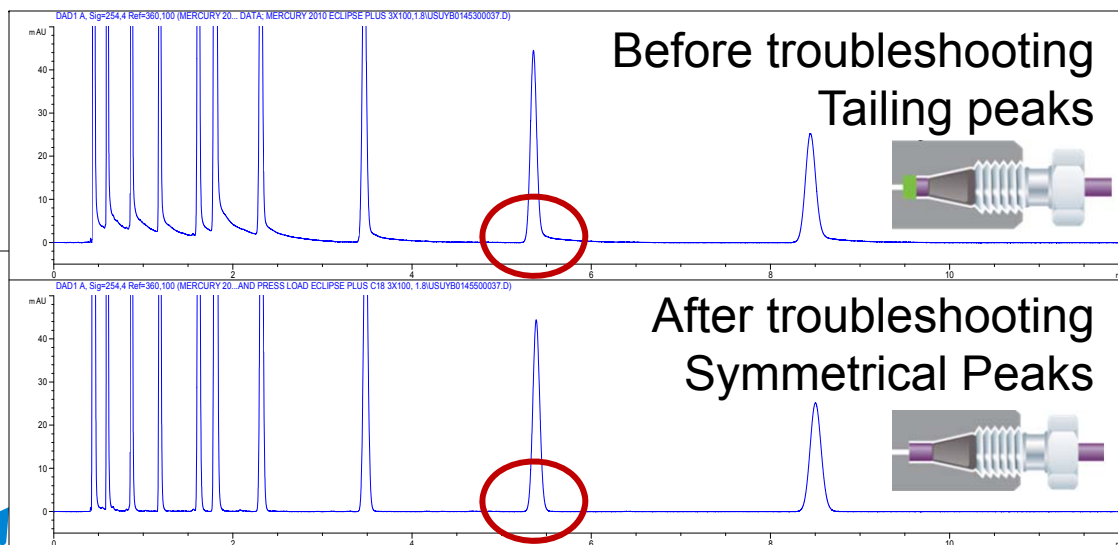

# Standard LC fittings: Swaging

Step 1



Select a nut that is the right length for the fitting.

Step 2



Slide the nut over the end of the tubing.

Step 3



Carefully slide the ferrule components on after the nut. Finger-tighten the assembly while making sure the tubing is completely seated in the bottom of the fitting.

Step 4



Use a wrench to gently tighten the fitting by 1/4 to 1/2 turn where you want to connect it; this will force the ferrule to seat onto the tubing. Do not over-tighten!

Step 5



Once you are sure your fitting is complete, loosen the nut and inspect the ferrule for correct position on the tubing.

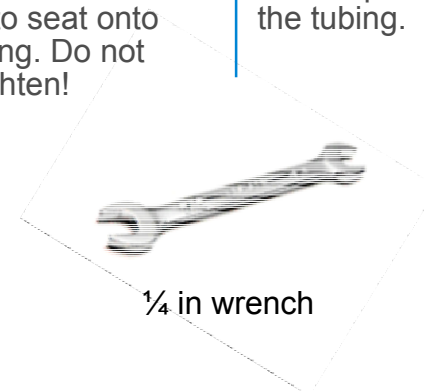

1/4 in wrench

➤ **Avoid pitfalls – Check out Agilent on YouTube**  
<https://www.youtube.com/user/agilent>



# InfinityLab (A-line) Quick Connect Fitting: Unique spring-loaded design

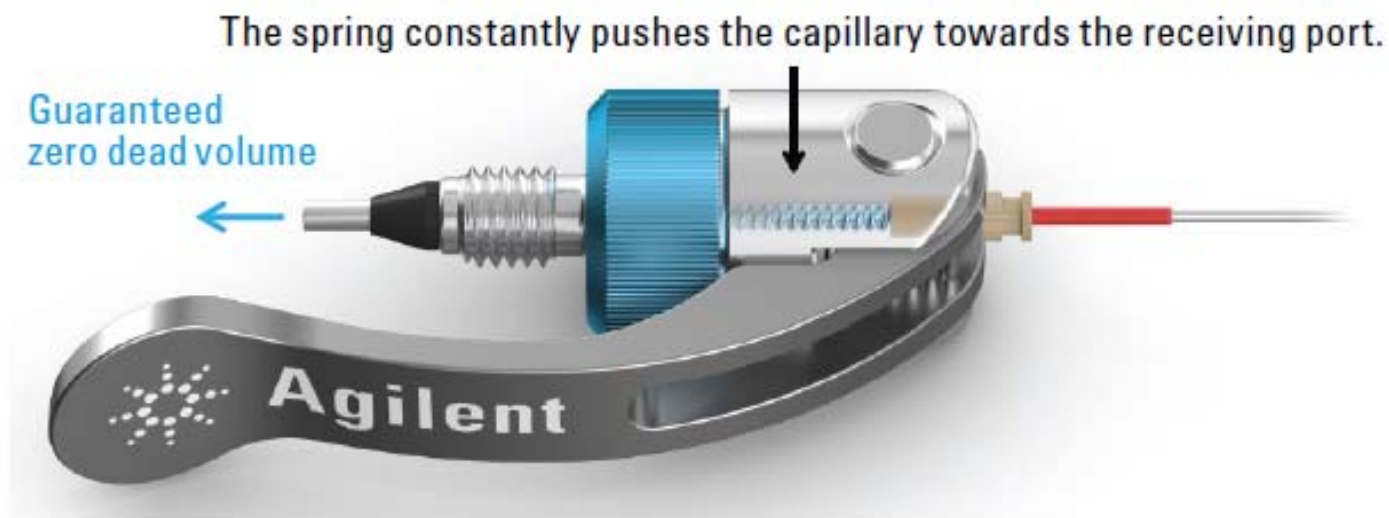

- Unique Spring-loaded design applies a constant force to eliminate dead volume
- Fingertight to 1300 bar



# Quick Connect: Leak-free connections with the push of a lever



Finger tighten the fitting until you feel the resistance, then close the lever



- **Avoid connection pitfalls -**  
<http://www.agilent.com/en-us/products/liquid-chromatography/lc-supplies/capillaries-fittings/a-line-fittings/agilent-a-line>

# InfinityLab Fittings & Special capillaries

The Quick Connect fitting is great for the column connection, where you connect and disconnect most often.



Quick Connect fitting requires capillary with spring and a PEEK component



Quick Turn for other points, where there isn't room for the Quick Connect, e.g. the injector or detector



Quick Turn fitting needs capillary with long socket due to its internal spring action

- A wide variety of capillary lengths and inner diameters are available to meet HPLC and UHPLC needs
- Capillaries and ferrules are completely user replaceable
- **Avoid connection**  **with InfinityLab fittings**

# To Ensure the Best Performance of a 2.1 x 50 mm, 2.7 $\mu\text{m}$ Poroshell 120 EC-C18 Column: [Improve LC Capillary Connections](#)

System Modifications	Pressure (bar)	k' (naphthalene)	TF(naphthalene)	N(naphthalene)
Starting Method: DAD = 5 Hz	159	2.3	1.06	3962
Increase DAD to 20 Hz	159	2.3	1.14	7786
Increase DAD to 80 Hz	159	2.3	1.15	8317
Exchange flow path for 0.08 mm id cap + 0.6 $\mu\text{L}$ flow cell	188	2.4	1.00	9387
<b>Install A-Line Fitting</b>	<b>182</b>	<b>2.4</b>	<b>1.00</b>	<b>9917</b>

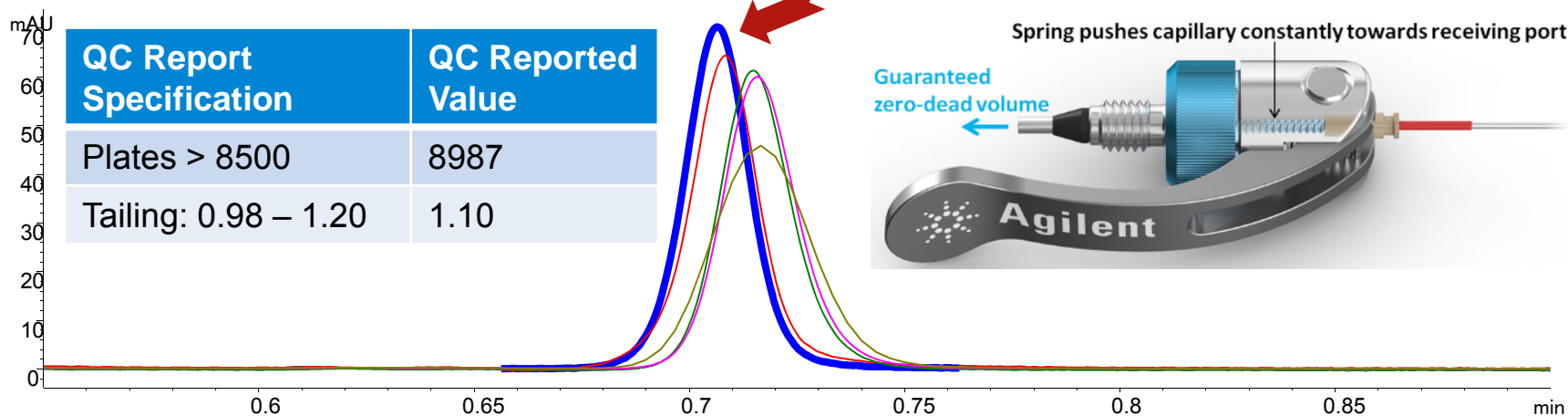

A: water, B: acetonitrile, 0.50 mL/min at 65% B, 0.5  $\mu\text{L}$  injection of Newport QC standard), 80  $\mu\text{g}/\text{mL}$  naphthalene, 25  $^{\circ}\text{C}$ , DAD: 254, 8 nm at 80, 20 or 5 Hz

# Do NOT Use Random Pieces of Tubing

0.12 x 105 mm Red Tubing (1.2  $\mu$ L)

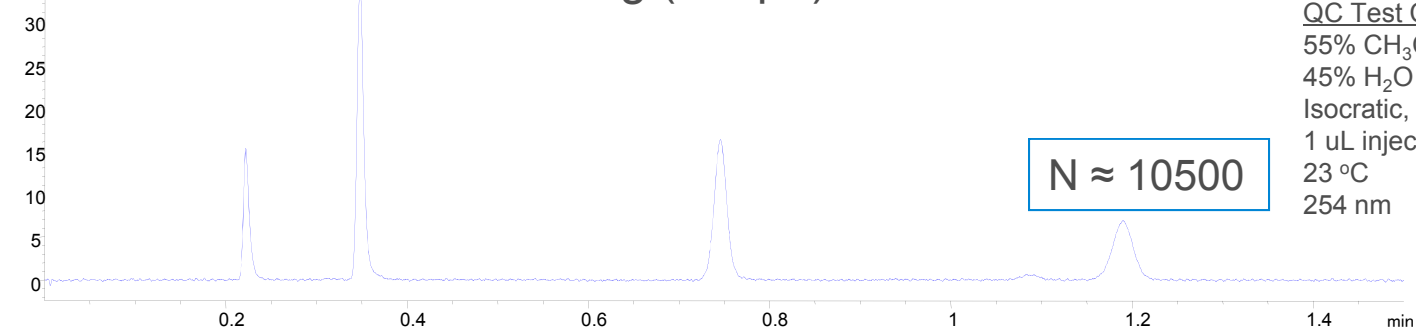

QC Test Conditions:  
55% CH<sub>3</sub>CN  
45% H<sub>2</sub>O  
Isocratic, 0.6 mL/min  
1  $\mu$ L injection of QC Mix  
23 °C  
254 nm

0.25 x 700 mm Blue Tubing (34.4  $\mu$ L)

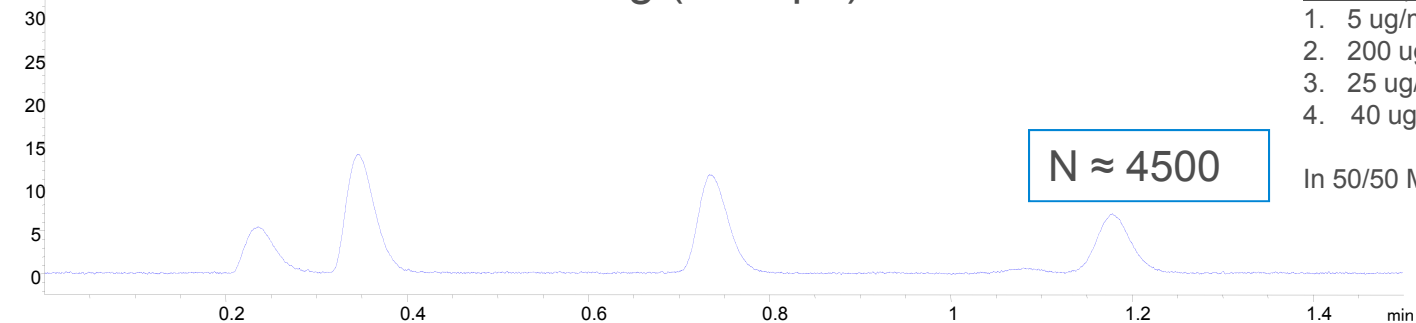

QC Mix (in elution order):  
1. 5  $\mu$ g/mL uracil  
2. 200  $\mu$ g/mL phenol  
3. 25  $\mu$ g/mL 4-chloro-nitrobenzene  
4. 40  $\mu$ g/mL naphthalene  
  
In 50/50 MeCN/Water

➤ QC test of a 2.1 x 50 mm, 1.8- $\mu$ m Eclipse Plus C18 showing peak broadening when larger volume tubing is installed between the autosampler and column. 43% of the efficiency lost with too much extra column volume

➤ **To avoid this pitfall** - Minimize extra column volume contribution from tubing by using the shortest length you can with the appropriate diameter and make proper connections

---

# Detector – Which One & Why

## ➤ UV/DAD

- Popular, simple to use, reliable, sensitive
- Sample must have UV absorbance

## ➤ MS

- Sensitive
- Sample must be ionizable

## ➤ RI

- Refractive Index; difference between analyte and mobile phase
- Need strict temperature control

## ➤ ELSD

- Independent of a compound's absorbance, fluorescence, or electro-activity
- Enables detection of semi-volatile and thermally sensitive compounds

## ➤ FLD

- More selective and can be more sensitive
- Compounds must fluoresce; Compounds often derivatized

## ➤ ECD

- Very sensitive
- Can produce severe noise

---

# UV Detector

## ➤ Sample

## ➤ Appropriate wavelength

- Sample
- Reference
  - Selecting Reference Wavelength in DAD Spectroscopy,  
<http://www.chem.agilent.com/Library/Support/Documents/faq184.pdf>
  - How To Select Reference Wavelength on DAD or MWD,  
<http://www.chem.agilent.com/Library/Support/Documents/faq182.pdf>
- Mobile phase components
  - UV Cutoff

## ➤ Flow Cell

## ➤ Data rate

- Column size
- Response

# Flow Cells

Match flow cell volume to chromatographic peak widths

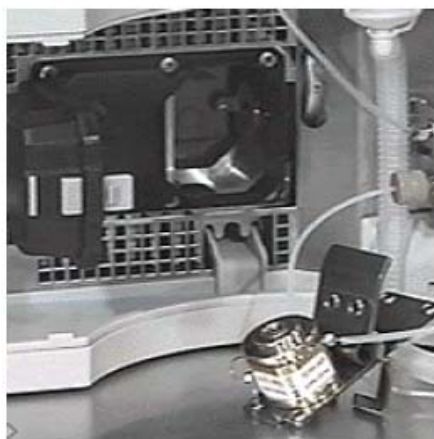

Flow Cell Volume/Pathlength	Uv Signal /Noise	Chrom. Resolution*
13 µl / 10 mm	+++	+
5 µl / 6 mm	++	++
1.7 µl / 6 mm	+	+++

\* Depends on analytical conditions and column dimension

## 13 µl Standard Flow Cell:

For highest sensitivity and linearity

4.6-3 mm ID; 2.7, 3.5, 5 µm columns

## 1.7 µl Micro Flow Cell:

For highest resolution

UHPLC, 1.8, 2.7 µm

2.1-1 mm ID columns

## 5 µl Semi-micro Flow Cell:

Best compromise of sensitivity & selectivity

HPLC/UHPLC, 1.8 to 5 µm

4.6 – 1 mm ID columns

Other flow cells include:

Max-Light Cartridge cells for Infinity DAD

500 nL for capillary LC

80 nL for nano LC

0.6 mm for Prep LC

# Effect of Detector Response Time on Fast Gradient Analyses

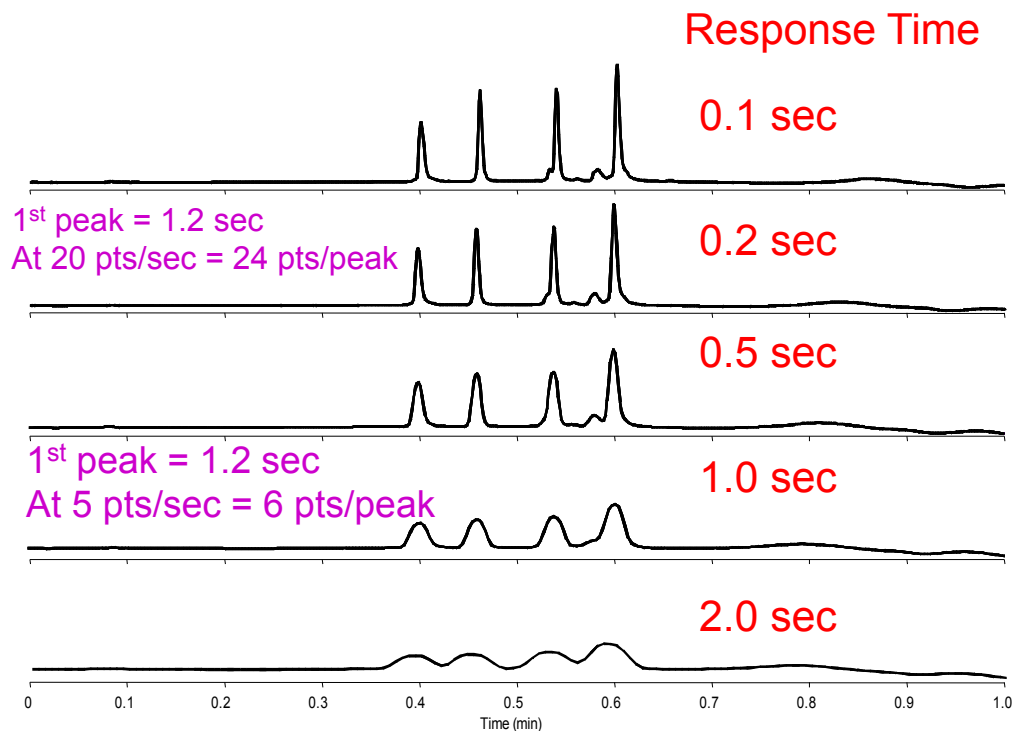

Agilent 1100 DAD  
Agilent 1100 WPS with ADVR

Column: Poroshell 300SB-C18  
2.1 x 75 mm, 5 mm

Mobile Phase:

A: 95% H<sub>2</sub>O, 5% ACN with 0.1% TFA

B: 5% H<sub>2</sub>O, 5% ACN with 0.1% TFA

Flow Rate: 2 mL/min

Temperature: 70°C

Detector: UV 215 nm

Piston stroke: 20

Sample:

1. Neurotensin 3. Lysozyme

2. RNaseA 4. Myoglobin

- You may have to adjust the response rate of your detector for rapid peak detection
- To avoid missing the peak, make sure detector is set properly
  - Need ~25 data points to accurately “describe” a chromatographic peak.

[http://www.chem.agilent.com//Library/Support/Documents/FAQ\\_Approved\\_PDF\\_Template\\_enough\\_datapoints.pdf](http://www.chem.agilent.com//Library/Support/Documents/FAQ_Approved_PDF_Template_enough_datapoints.pdf)



---

# Column

## Cautions and Potential Pitfalls

- Performance Report
- Not all C18 (L1) columns are the same
- What kills a column
- Pressure
- Lot-to-lot



# Performance Report

SERIAL NUMBER: USDAZ01333

PART NUMBER: 959758-902  
COLUMN TYPE: ZORBAX RRHD Eclipse Plus C18 2.1 x 100 mm, 1.8  $\mu$ m  
PACKING LOT #: B09089

**TEST CONDITIONS**  
MOBILE PHASE = 60% Acetonitrile / 40% Water  
COLUMN PRESSURE = 517.2 Bar  
COLUMN FLOW = 0.50 ml / min  
LINEAR VELOCITY = 0.436 cm / sec  
TEMPERATURE = AMBIENT (Nominally 23 °C)  
INJECTION VOLUME = 1  $\mu$ l

## QUALITY CONTROL PERFORMANCE RESULTS FOR NAPHTHALENE

TEST VALUES	SPECIFICATIONS
THEORETICAL PLATES = 22337	MIN = 21000
SELECTIVITY = 1.90	RANGE = 1.82 - 1.92
USP TAILING FACTOR = 1.08 (@ 5% Peak Height)	RANGE = 0.98 - 1.20
$k'$ = 4.58	

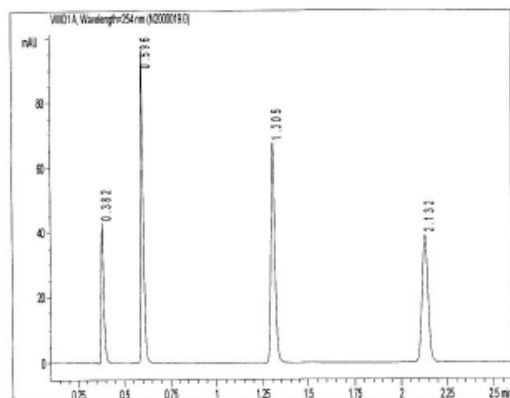

Sample components with concentrations diluted in mobile phase in the following elution order.

Peak #	Conc (ug/ml)	Sample Component
1	10	Uracil
2	400	Phenol
3	50	4-Chloro Nitrobenzene
4	80	Naphthalene

➤ Manufacturing test chromatogram is done on a modified LC system to minimize extra column volume and will differ from a typical lab instrument

- Don't expect to get the exact same result as the performance report
- Test column performance on your instrument to have as a reference

# Not All C18s Are The Same

## 1<sup>st</sup> choice

Best Resolution  
& Peak Shape

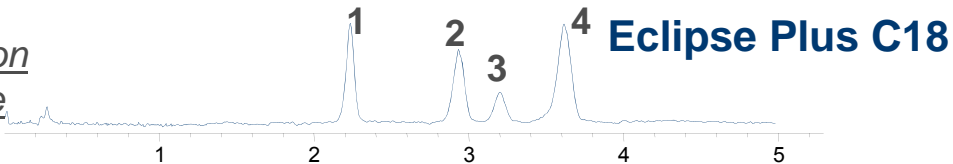

## 2<sup>nd</sup> choice

Good alternate selectivity  
due to non-encapped

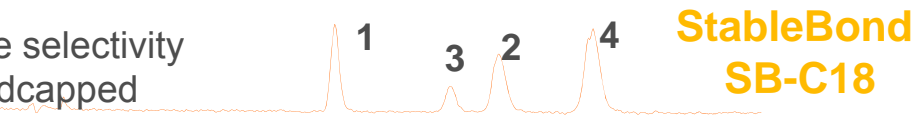

## 3<sup>rd</sup> choice

Good efficiency & peak shape  
Resolution could be achieved

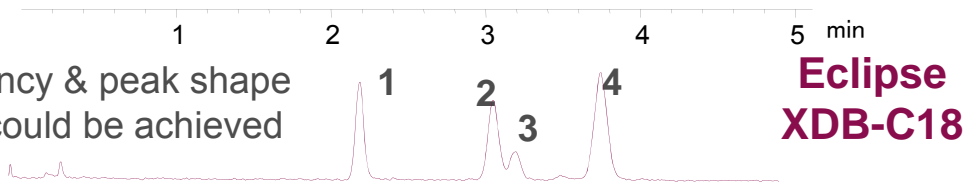

## 4<sup>th</sup> choice

Resolution not likely,  
Other choices better for this  
separation.

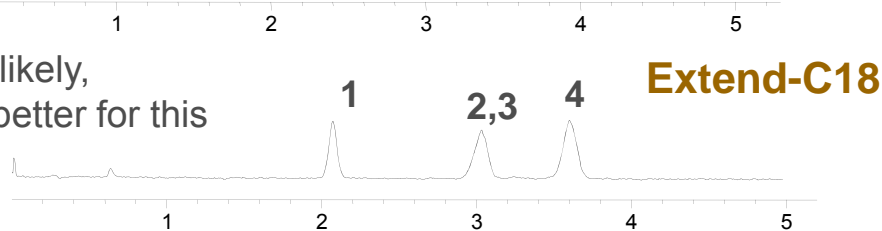

Mobile phase: (69:31) ACN: water  
Flow 1.5 mL/min.

Temp: 30 °C

Detector: Single Quad ESI  
positive mode scan

**Columns: RRHT**  
**4.6 x 50 mm 1.8 um**

Sample:

1. anandamide (AEA)
2. Palmitoylethanolamide (PEA)
3. 2-arachinoylglycerol (2-AG)
4. Oleoylethanolamide (OEA)

- Multiple bonded phases for most effective method development
- Match to one you are currently using
- *Method development kits are available*

➤ **Avoid this pitfall** - Don't assume every C18 will behave the same

# Column Lifetime

- Follow manufacturer's guidelines
- Method conditions that can affect column lifetime
  - pH
    - Low pH
      - pH<3 – acid hydrolysis of bonded phase
      - Retention time changes, resolution changes, increased peak tailing
    - High pH
      - Silica-based packing has some solubility at higher pH
  - Temperature
    - Poor temp choice can accelerate the dissolution of the silica above pH 6.
  - Buffer Choice
    - Avoid phosphate & carbonate buffers at high pH
  - Crud
    - Column contamination
    - Plugged frit
- Storage conditions
  - Columns should not be maintained at elevated pH or elevated temperature when not in use

# Operational Conditions

## Mobile Phase Effects on Column Life

Low pH (1-3) - Bonded Phase Loss by Acid Hydrolysis

### Conventional

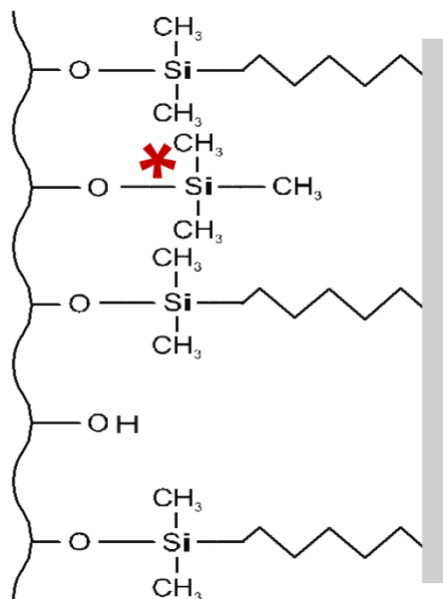

### StableBond

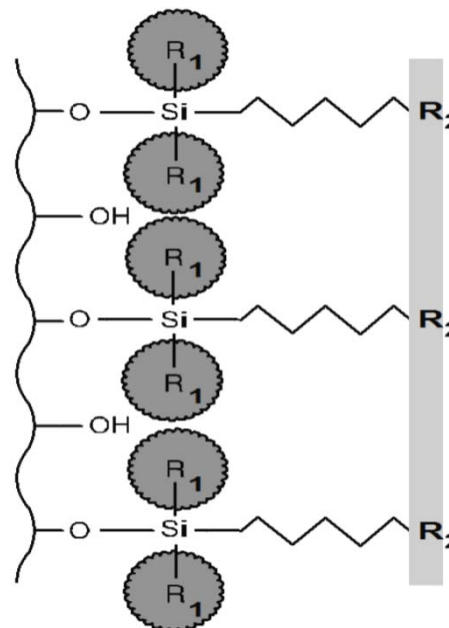

# Operational Conditions

## Mobile Phase Effects on Column Life

**Bonded-Phase Hydrolysis Rate Increases With Temperature**

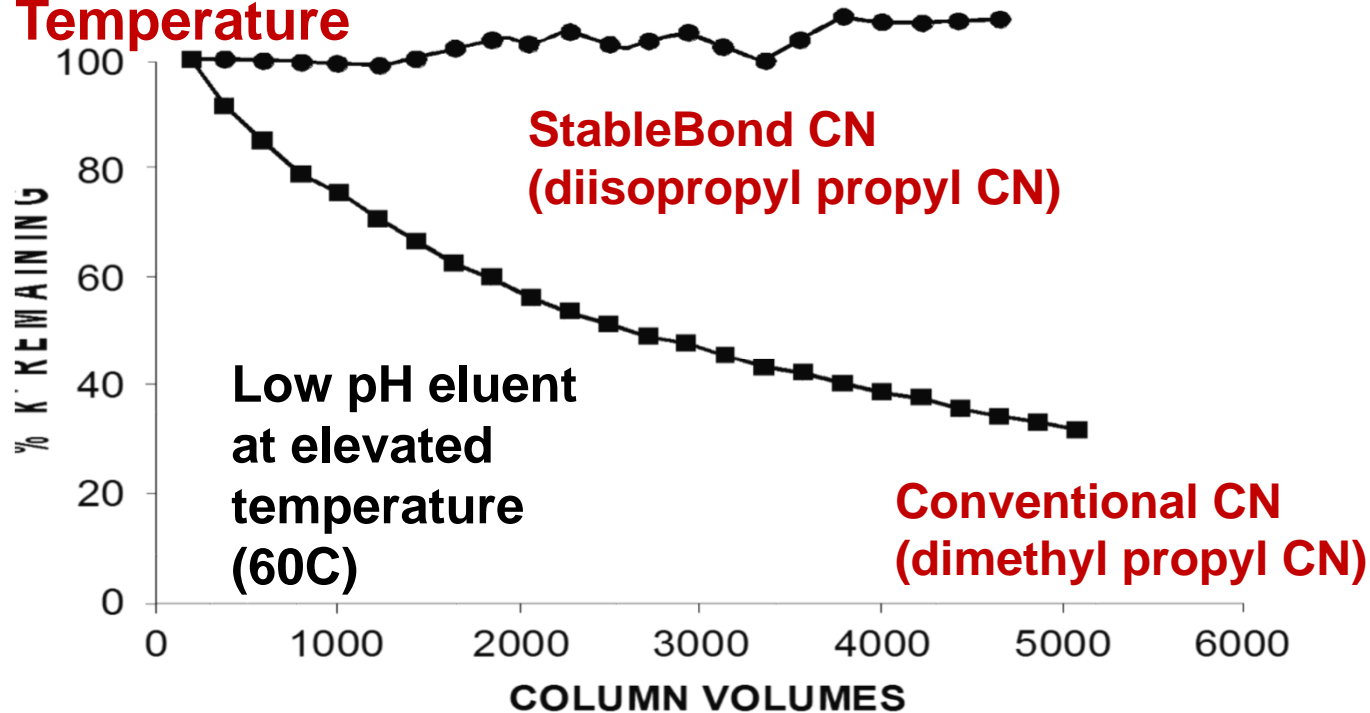

# Solubility of Amorphous Silica at Different pH Values

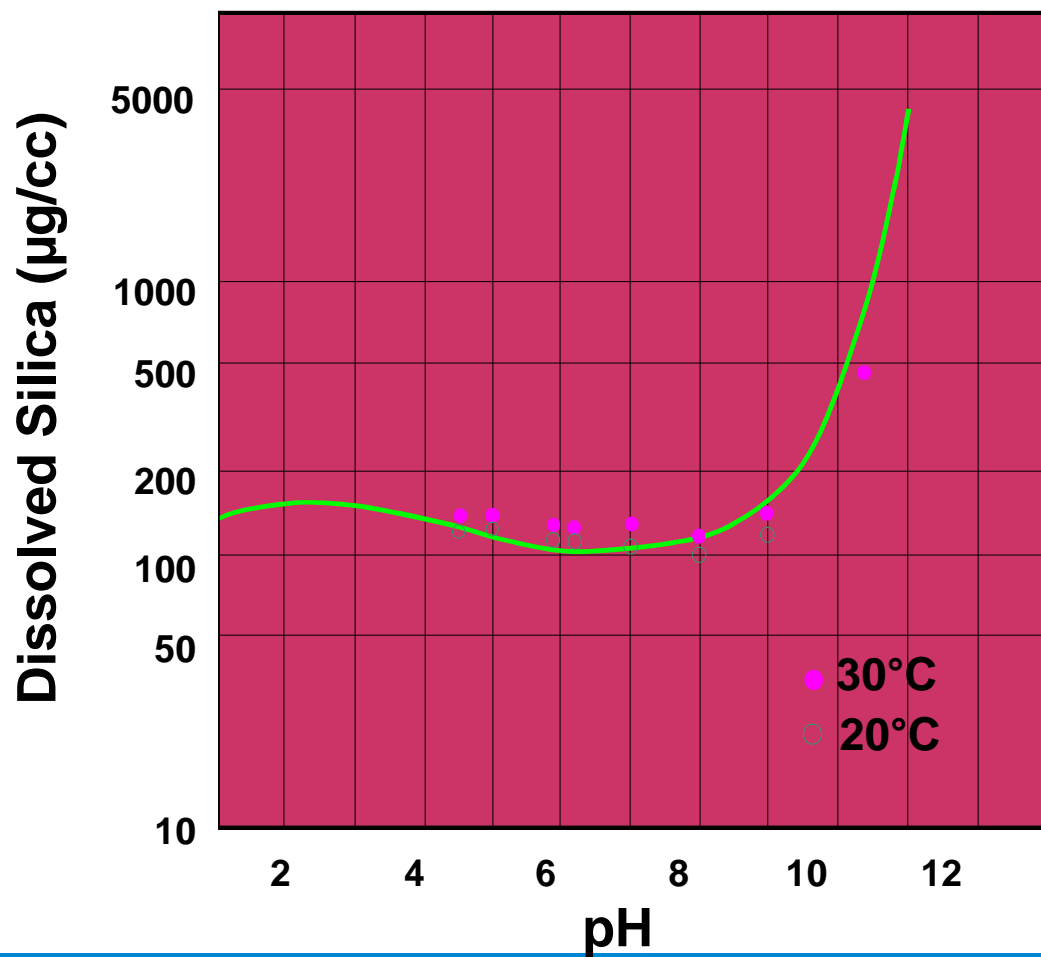

Solubility of silica increases dramatically above pH 8.0.

Column bonding chemistry plays a crucial role in stability of silica at high pH

# Column Lifetime with High pH Methods

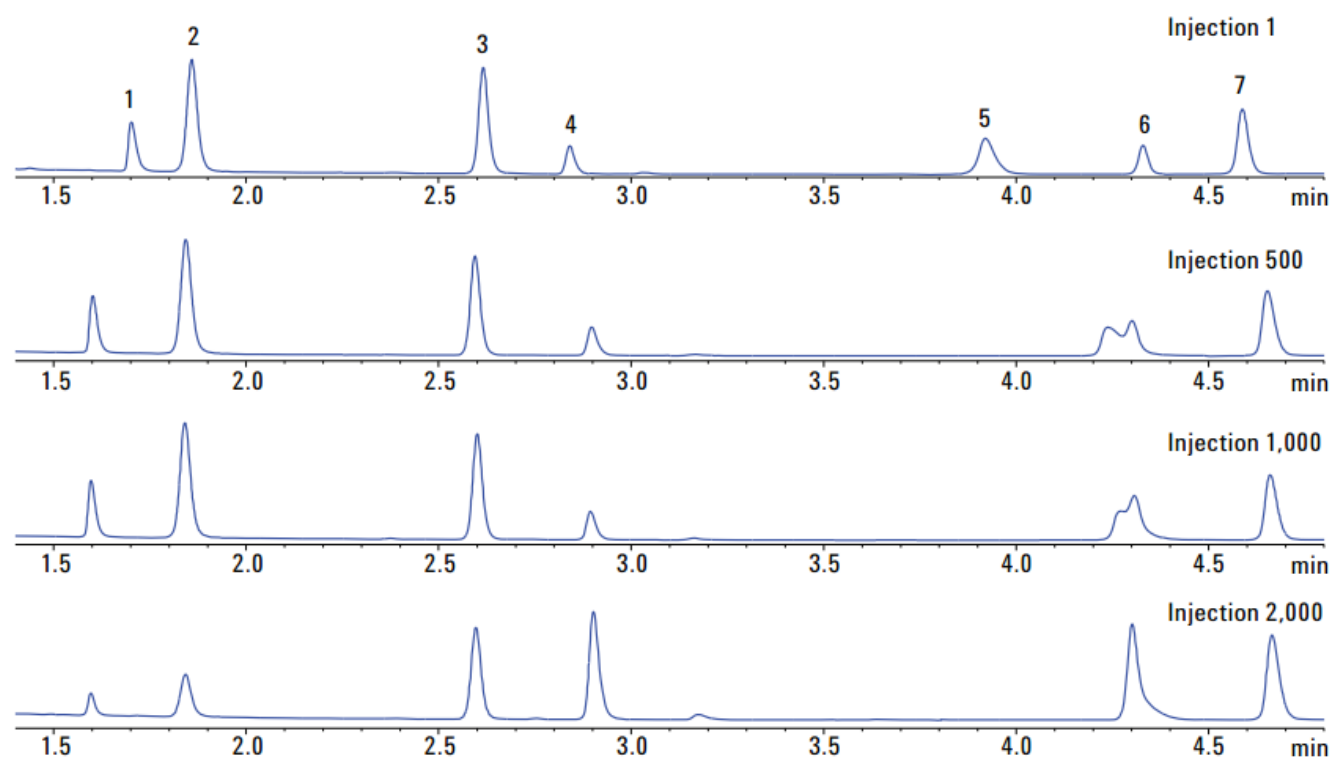

- Peak ID**
1. Methyl salicylate
  2. 4-Chlorocinnamic acid
  3. Acetophenone
  4. Quinine
  5. Nortriptyline
  6. Heptanophenone
  7. Amitriptyline

**Conditions**

Column: Other brand,  
2.1 x 50 mm, 3  $\mu$ m

Eluent: A) 10 mM ammonium  
bicarbonate adjusted  
to pH 10.0 in water  
B) acetonitrile

Flow rate: 0.4 mL/min

Gradient:

Time (min)	%B
0	5
5	95
5.1	5

Total run time: 7 min

Other brand column on an ammonium bicarbonate gradient at pH 10.



# Column Lifetime with HPH-C18

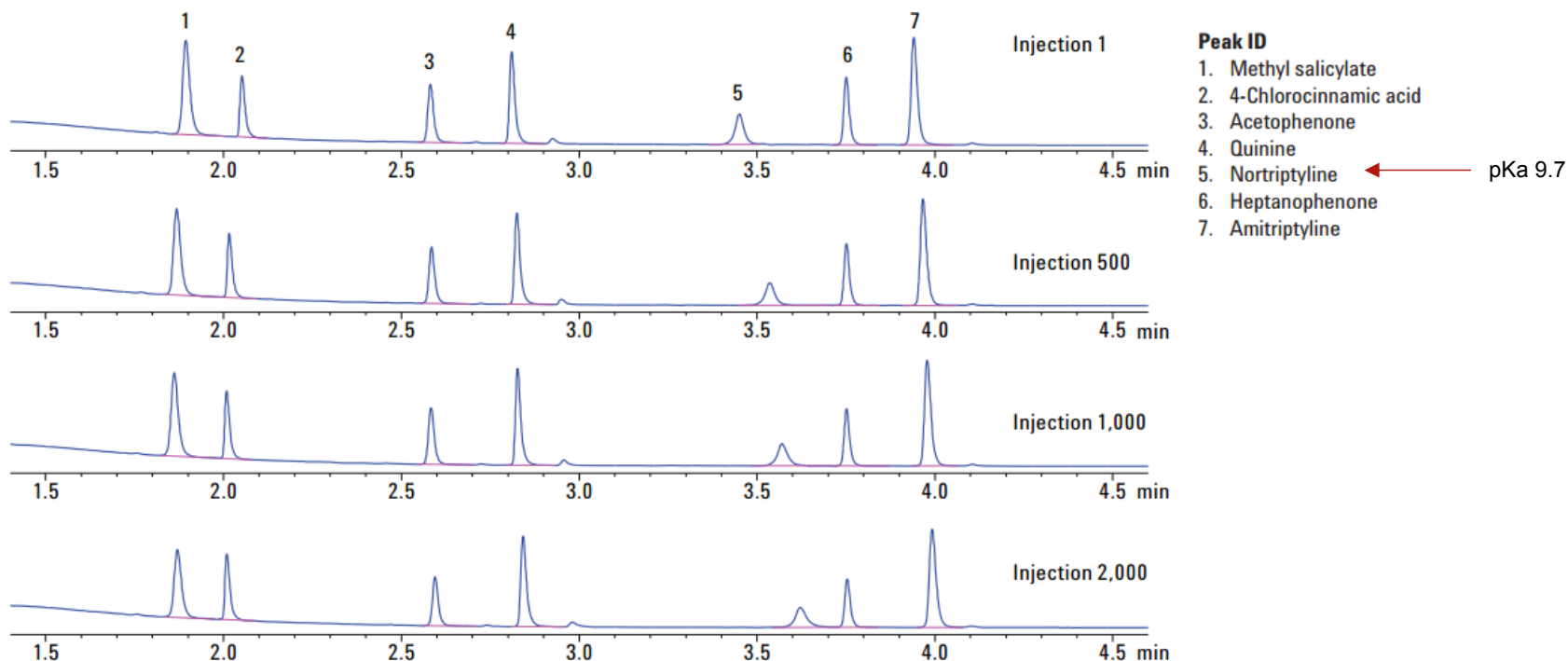

## Conditions

Column: Agilent Poroshell 120 HPH-C18, 2.1 × 50 mm, 2.7 μm  
Eluent: A) 10 mM ammonium bicarbonate adjusted to pH 10.0 in water  
B) acetonitrile  
Flow rate: 0.4 mL/min  
Gradient: 

Time (min)	%B
0	5
5	95
5.1	5

  
Total run time: 7 min

← *Same Conditions*

➤ **Avoid heartbreak** – Choose the right column for your conditions

# Peak Tailing from Column Contamination (CRUD)

Column: StableBond SB-C8, 4.6 x 250 mm, 5 $\mu$ m      Mobile Phase: 20% H<sub>2</sub>O : 80% MeOH      Flow Rate: 1.0 mL/min  
Temperature: R.T.      Detection: UV 254 nm      Sample: 1. Uracil      2. Phenol      3. 4-Chloronitrobenzene      4. Toluene

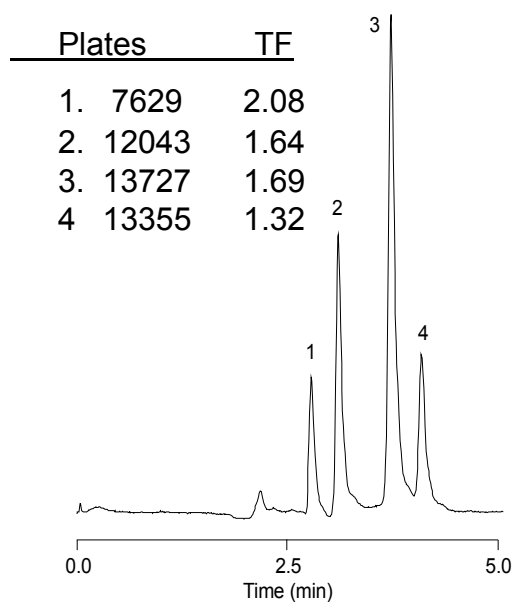

QC test forward direction

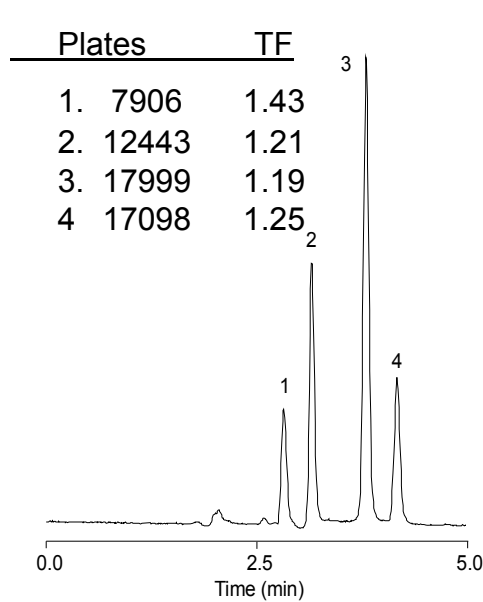

QC test reverse direction

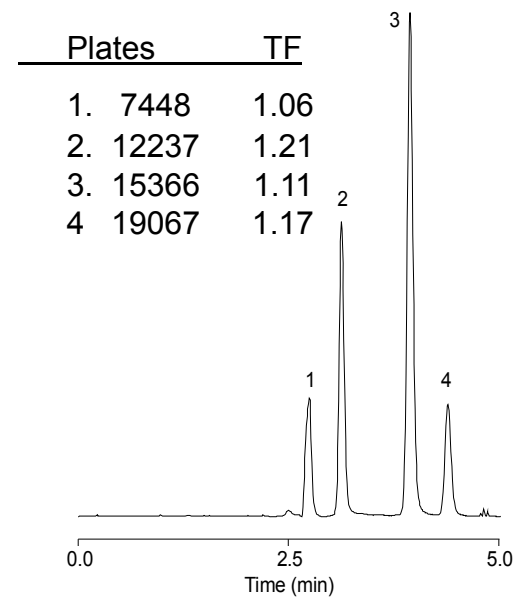

QC test after cleaning  
100% IPA, 35°C

- Good column hygiene can extend the life of your column
  - Column cleaning procedure (see appendix)

# Preventing Column Pressure Problems



1. Filter mobile phase:
  - filter non-HPLC grade solvents
  - filter buffer solutions
  - Install an in-line filter between auto-sampler and column (removes pump seal debris, injector rotor debris, and sample particulates). Use 2  $\mu\text{m}$  frit for 3.5  $\mu\text{m}$ /5 $\mu\text{m}$  columns, use 0.5  $\mu\text{m}$  (or smaller) frit for 1.8  $\mu\text{m}$ /2.7  $\mu\text{m}$  columns
2. Filter all samples and standards
3. Perform sample clean-up (i.e. SPE, LLE) on dirty samples.
4. Appropriate column flushing – flush buffers from entire system with water/organic mobile phase
5. Replace buffers every 24-48 hours, never add to the bottle, always use a new one



➤ **Avoid pressure pitfalls – Filter Samples**

# Lot-to-Lot Comparison of 5 Lots Poroshell 120 EC-C18

2010



2012

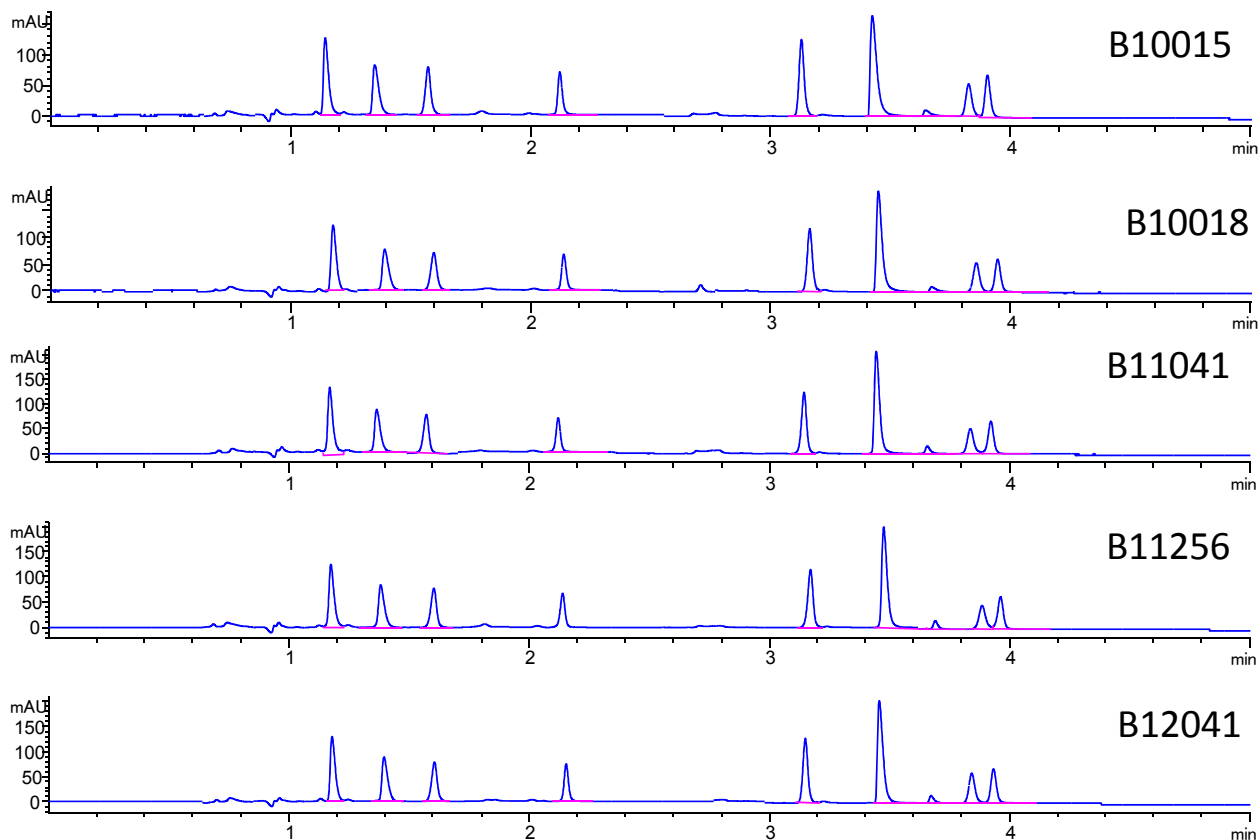

A 20 mM Ammonium Acetate pH 4.80 adjusted with 20 mM Acetic Acid B: Acetonitrile, 30 C, Sig= 230 nm,4: ref 360,100  
0.638 mL/min 10% to 40% B over 4 min, 3 x100 mm Poroshell 120 EC-C18  
2ul Ascorbic acid, acesulfane K, saccharin, caffeine, aspartame, sorbic acid, quinine, dehydroacetic acid

Agilent InfinityLab Poroshell 120 Columns for HPLC and UHPLC (Pub# 5991-7435EN)  
Agilent InfinityLab Poroshell 120 Columns 1.9um Columns for UHPLC (Pub# 5991-7352EN)



Agilent Technologies

Avoiding Beginner Pitfalls

# Lot-to-Lot Selectivity Change Related to pH Choice

pH 4.5 - Lot 1

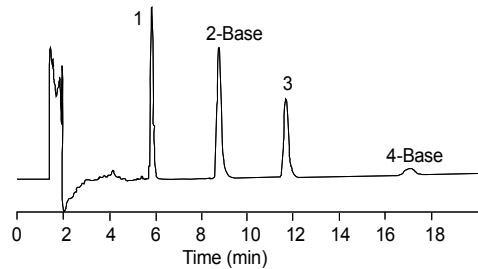

pH 3.0 - Lot 1

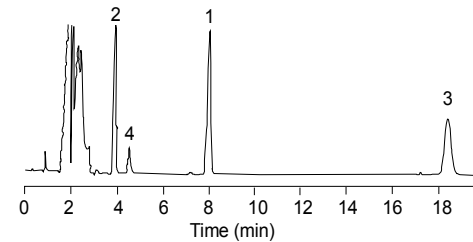

pH 4.5 - Lot 2

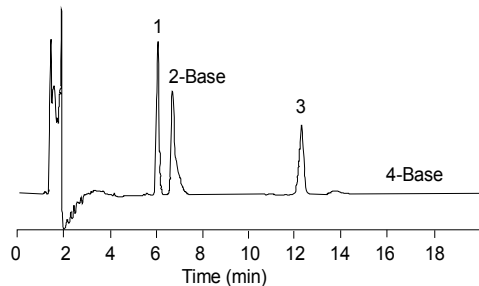

pH 3.0 - Lot 2

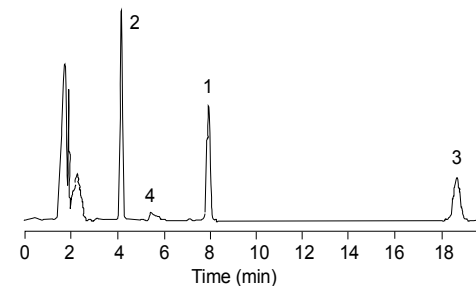

- pH 4.5 - selectivity change from lot-to-lot for basic compounds
- pH 3.0 - no selectivity change from lot-to-lot

➤ Avoid  - Do not validate on only 1 column lot!!!!!!!

- For Method Ruggedness
  - Test 3 different column lots
  - Compare  $R_s$  for the 3 lots
    - If  $\Delta R_s$  is too large, modify method



---

# Method Conditions

## Cautions and Potential Pitfalls

### ➤ Mobile phase

- What's in your mobile phase and why
- Don't believe everything you read; Focus of paper may not be chromatography
- Microbial growth
- Baseline
  - Drift
    - Additives, e.g., TFA
    - Detector, e.g., RI
  - Problems, [http://www.chem.agilent.com/Library/Support/Documents/Baseline\\_problems.pdf](http://www.chem.agilent.com/Library/Support/Documents/Baseline_problems.pdf)
- Mobile phase preparation
- Ghost Peaks
  - Sample
  - Mobile phase components; H<sub>2</sub>O, solvent, additives

### ➤ pH

### ➤ Temperature

### ➤ Injection problems

# Microbial Growth

## ➤ Potential problems

- Increased system pressure or pressure fluctuations
- Increased column pressure, premature column failure
- Can mimic application problems
- Gradient inaccuracies
- Ghost peaks
- Difficult to remove if gets in degasser and rest of system

## ➤ Prevent and/or Reduce Microbial Growth

- Use freshly prepared mobile phase
- Filter
- Do not leave mobile phase in instrument for days without flow
- Always discard “old” mobile phase
  - Do not add fresh mobile phase to old
- Use an amber solvent bottle for aqueous mobile phase
- If possible, can add
  - 5% organic added to water can be used to reduce bacterial growth
  - Few mg/l sodium azide

- To avoid contaminating your system and column, prevent microbial growth
- Check your instrument manual for guidelines

# Baseline Drift

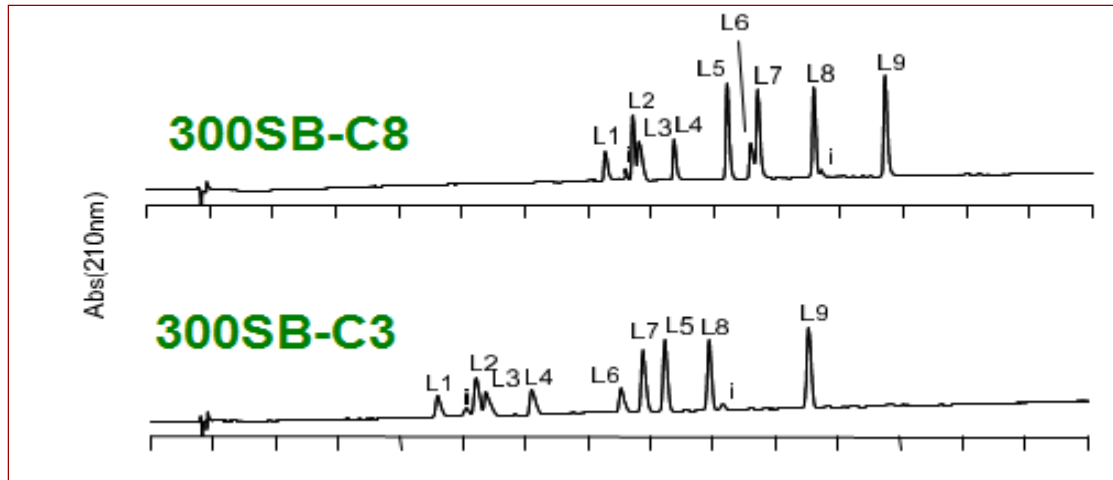

## Conditions:

Columns: ZORBAX 300SB, 4.6 x 150 mm, 5  $\mu$ m

Mobile Phase: Gradient, 0 - 26% B in 30min.

A = 0.1% TFA in Water

B = 0.1% TFA in Acetonitrile

Temperature: 40°C

Sample: 2  $\mu$ g of each peptide

Flow Rate: 1.0 mL / min.

Detection: UV-210nm

➤ Know the UV Cutoff of your mobile phase components



# Mobile Phase Preparation

- HPLC grade or better
- Buffer preparation procedure
  - Be consistent
  - Document the process
- Volume % of solvents can depend on preparation

Specified volume ACN added to a 1 L volumetric and made to volume with H<sub>2</sub>O

≠

Specified volume H<sub>2</sub>O added to a 1 L volumetric and made to volume with ACN

≠

500 ml H<sub>2</sub>O added to 500 ml ACN

➤ Small changes in mobile phase strength can have a large effect on retention

# Mobile Phase Preparation Effect on Chromatography

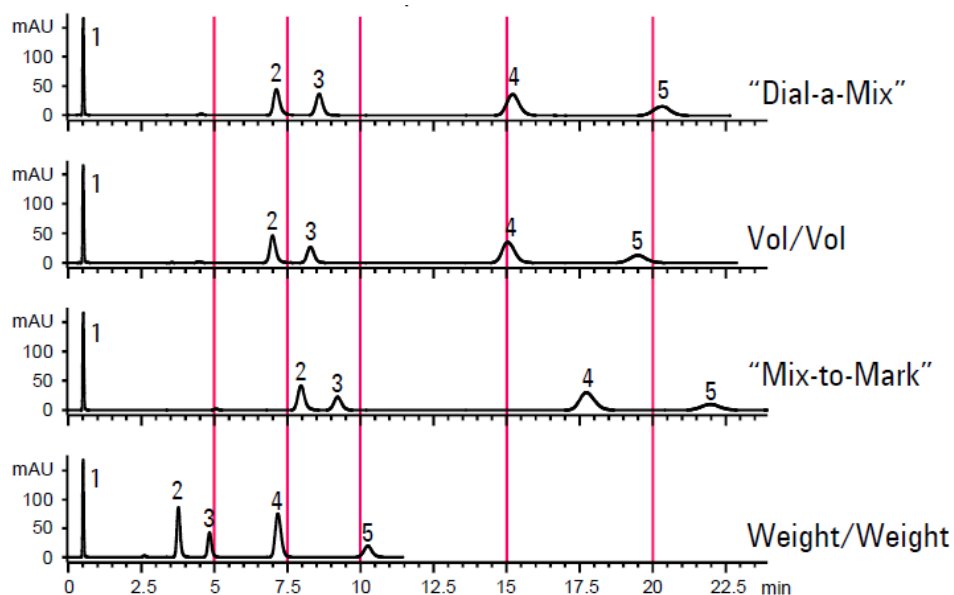

HPLC System: Agilent 1100 with quaternary pump  
Column: ZORBAX Eclipse XDB-C8 Rapid-Resolution (3.5 $\mu$ m), 4.6 x 50 mm  
Agilent Part No. 935967-906  
Mobile Phases: Dial-a-Mix= A: water B: MeOH, pump 50% B  
Vol/Vol=250 mL water + 250 mL MeOH, pump 100%  
Mix-to-Mark = 250 mL MeOH, fill to 500 mL with water, pump 100%  
Premixed (w/w) = 200 g MeOH + 200 g water, pump 100%  
Detection: UV 254 nm  
Flow: 1 mL/ min.  
Temperature: ambient

1. Uracil
2. Butylparaben
3. Naphthalene
4. Dipropylphthalate
5. Acenaphthene

- Method used to prepare MP can significantly affect the elution pattern
- To avoid this potential pitfall
  - Be consistent
  - w/w is more accurate than v/v

Effect of Mobile Phase Preparation on Chromatography,  
Pub. No. 5988-6476EN

# Ghost Peaks

## Where Do They Come From

- Organic
- Additives
  - TFA
  - Salts
- H<sub>2</sub>O
- Sample
- Other

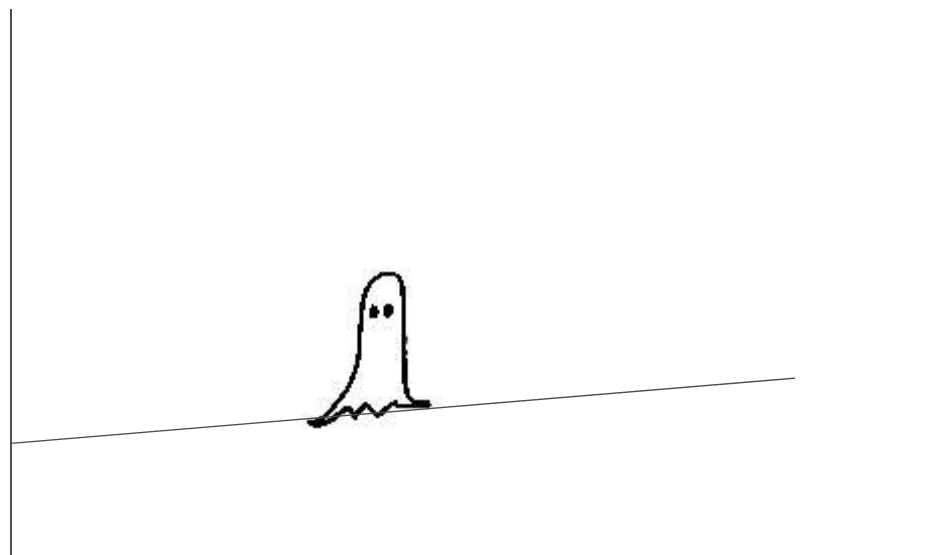

# Acetonitrile Comparison

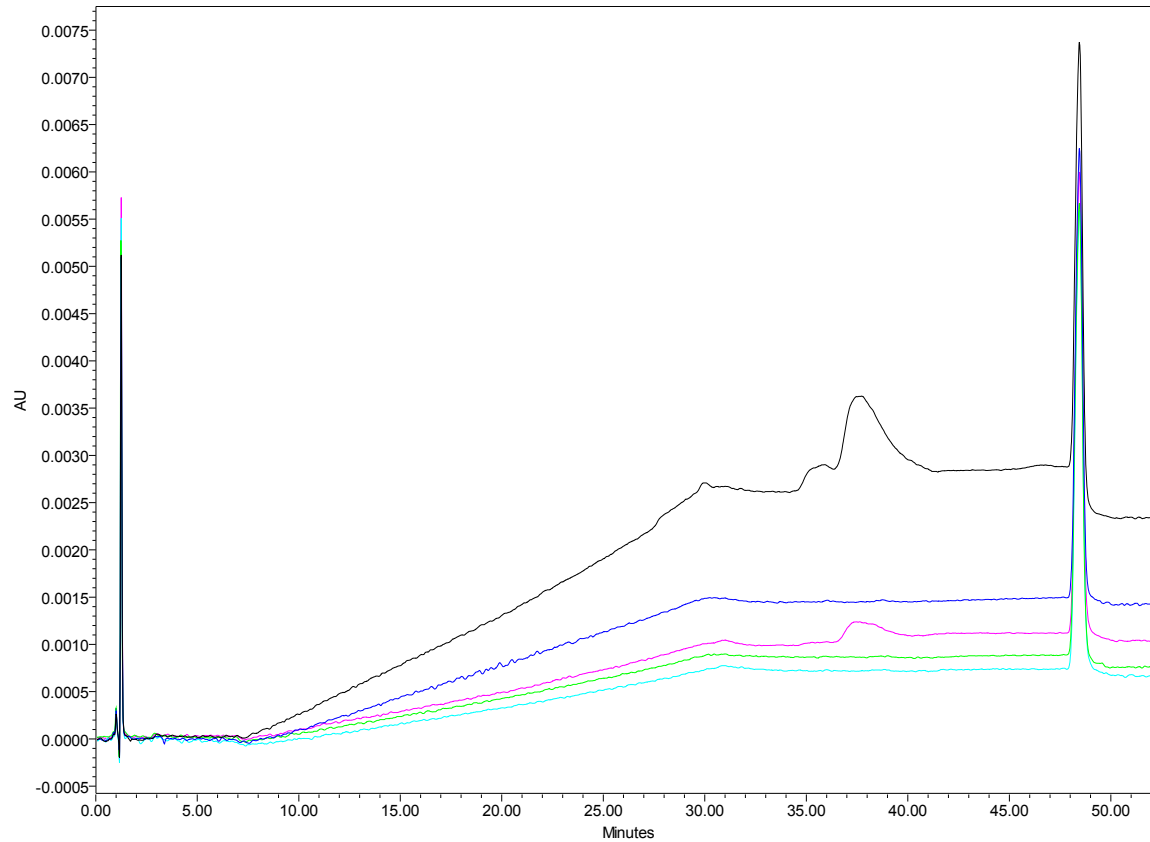

Multiple suppliers and lots of ACN tested

➤ Solvent - quality and consistency



# Ghost Peaks

The LC system was equilibrated at starting conditions for 30min, then a gradient run was made. Impurities were trapped and eluted out with the gradient.

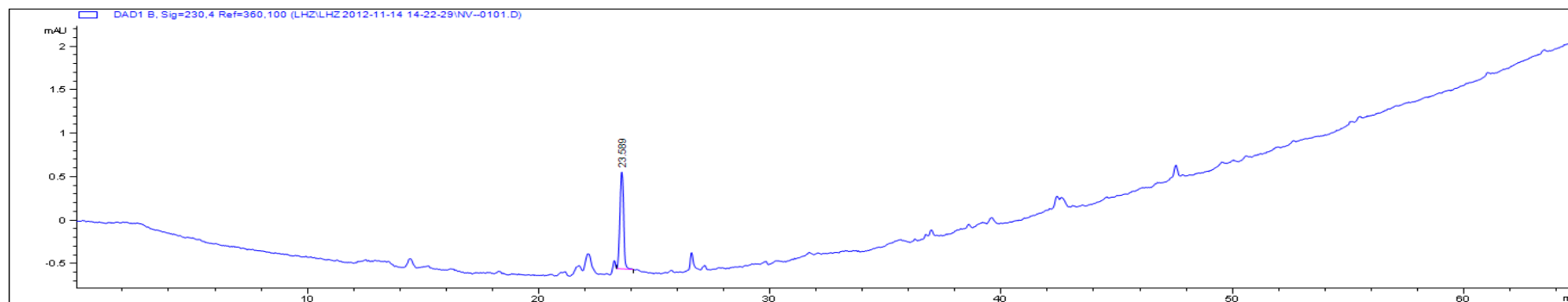

When an injection is made with minimal equilibration, a much cleaner baseline was observed.

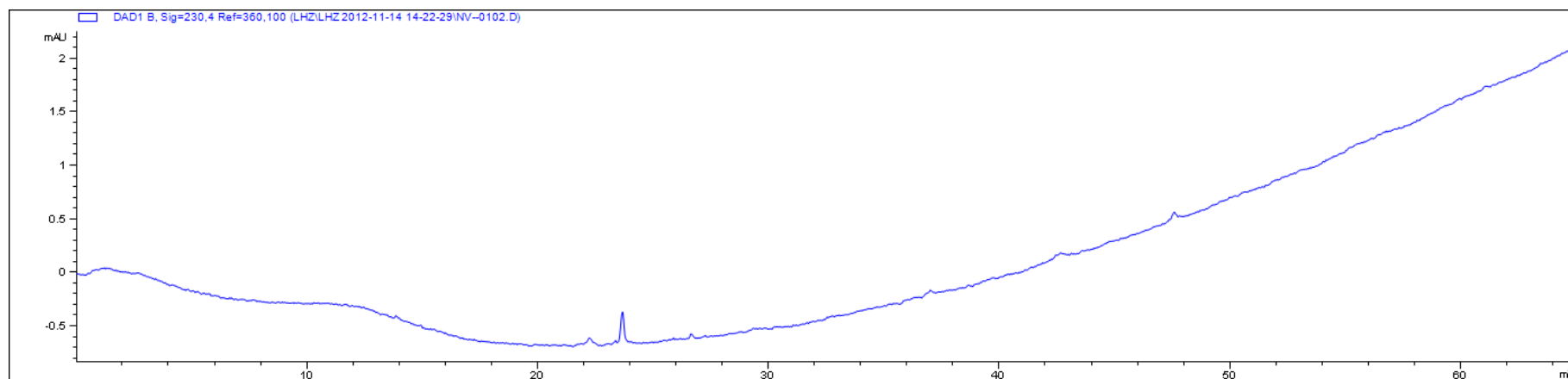

# Choosing the Best Syringe Filters

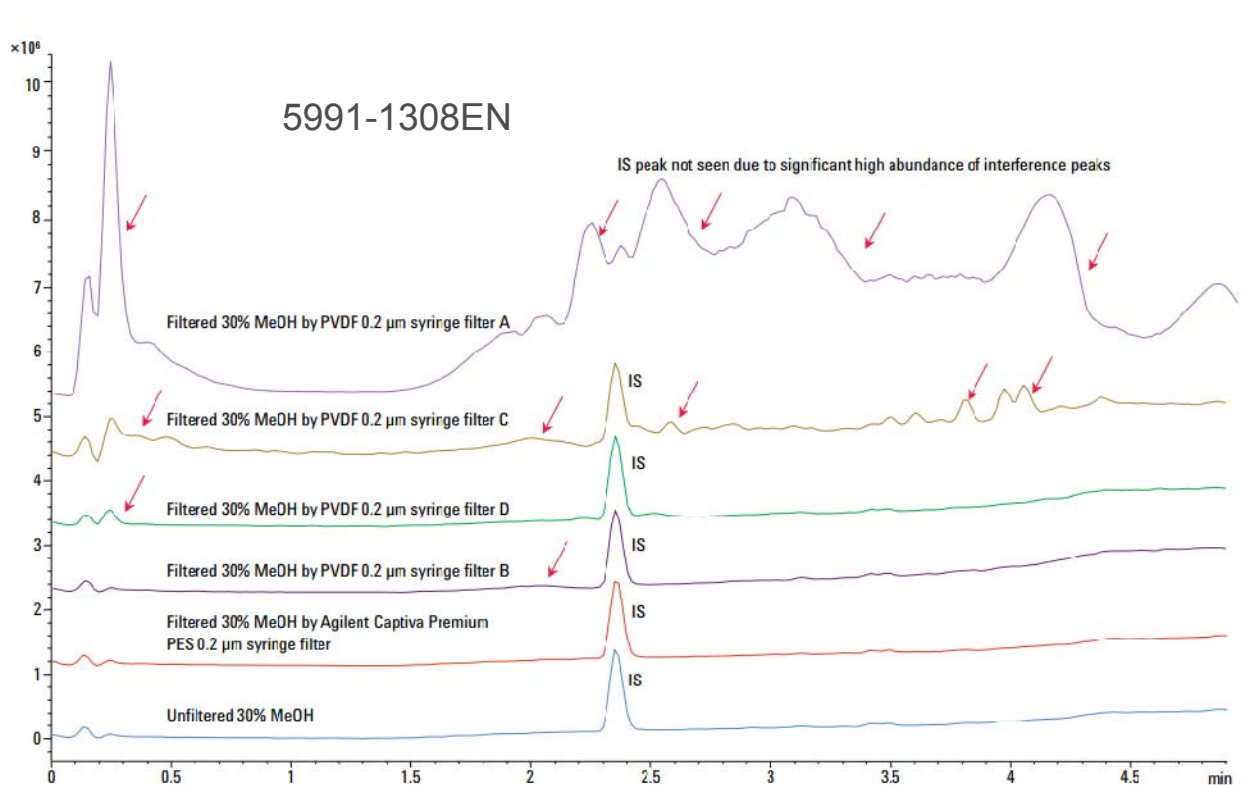

Filter cleanliness comparison of the Agilent Captiva Premium PES syringe filter with non-Agilent PVDF syringe filters using LC/MS under positive mode.

UHPLC: Agilent 1290 Infinity LC System  
 Column: Agilent ZORBAX RRHD Eclipse Plus C18, 2.1 x 50 mm, 1.8 µm (p/n 959757-902)  
 Mobile phases: A: H<sub>2</sub>O + 0.01% formic acid (FA)  
 B: Acetonitrile + 0.01% FA  
 Flow rate: 0.5 mL/min, gradient  
 Total run time: 5 min plus 1 min post run  
 Gradient: Hold at 30% B for 1 min, then ramped to 90% B in 3 min, and hold at 90% B for 1 min  
 Injection volume: 8 µL  
 Internal standard: 50 µg/mL Naproxin  
 MS: Agilent 6150 Single Quadrupole LC/MS System  
 Source: ESI with Agilent Jet Stream Technology (AJS-ES)  
 Capillary voltage: 4,000 V  
 Nozzle voltage: 2,000 V  
 Drying gas flow: 12 L/min  
 Drying gas temp: 250 °C  
 Nebulizer pressure: 35 psig  
 Sheath gas flow: 3.0 L/min  
 Sheath gas temp: 150 °C  
 Mass range: 100 – 1350 m/z  
 Fragmentor: 150 V (pos), 80 V (neg)

- Select a syringe filter appropriate for your sample and solvent used
- **Make sure it does not add unwanted interferences** ❤️

<http://filtrationselectiontool.chem.agilent.com>

Captiva Filtration Selection Guide: 5991-1230EN

# Method Conditions

## ➤ Mobile phase

- What's in your mobile phase and why
- Don't believe everything you read; Focus of paper may not be chromatography
- Microbial growth
- Baseline
  - Drift
    - Additives, e.g., TFA
    - Detector, e.g., RI
  - Problems, [http://www.chem.agilent.com/Library/Support/Documents/Baseline\\_problems.pdf](http://www.chem.agilent.com/Library/Support/Documents/Baseline_problems.pdf)
- MP prep
- Ghost Peaks
  - Sample
  - Mobile phase components; H<sub>2</sub>O, solvent, additives

## ➤ pH

- High
- Low

## ➤ Temperature

## ➤ Injection problems

- Sample solvent
- Injection volume

# Change in Retention with pH for Ionizable Compounds is Compound-Dependent

More retention for non-charged analytes (i.e. acids at low pH and bases at high pH)

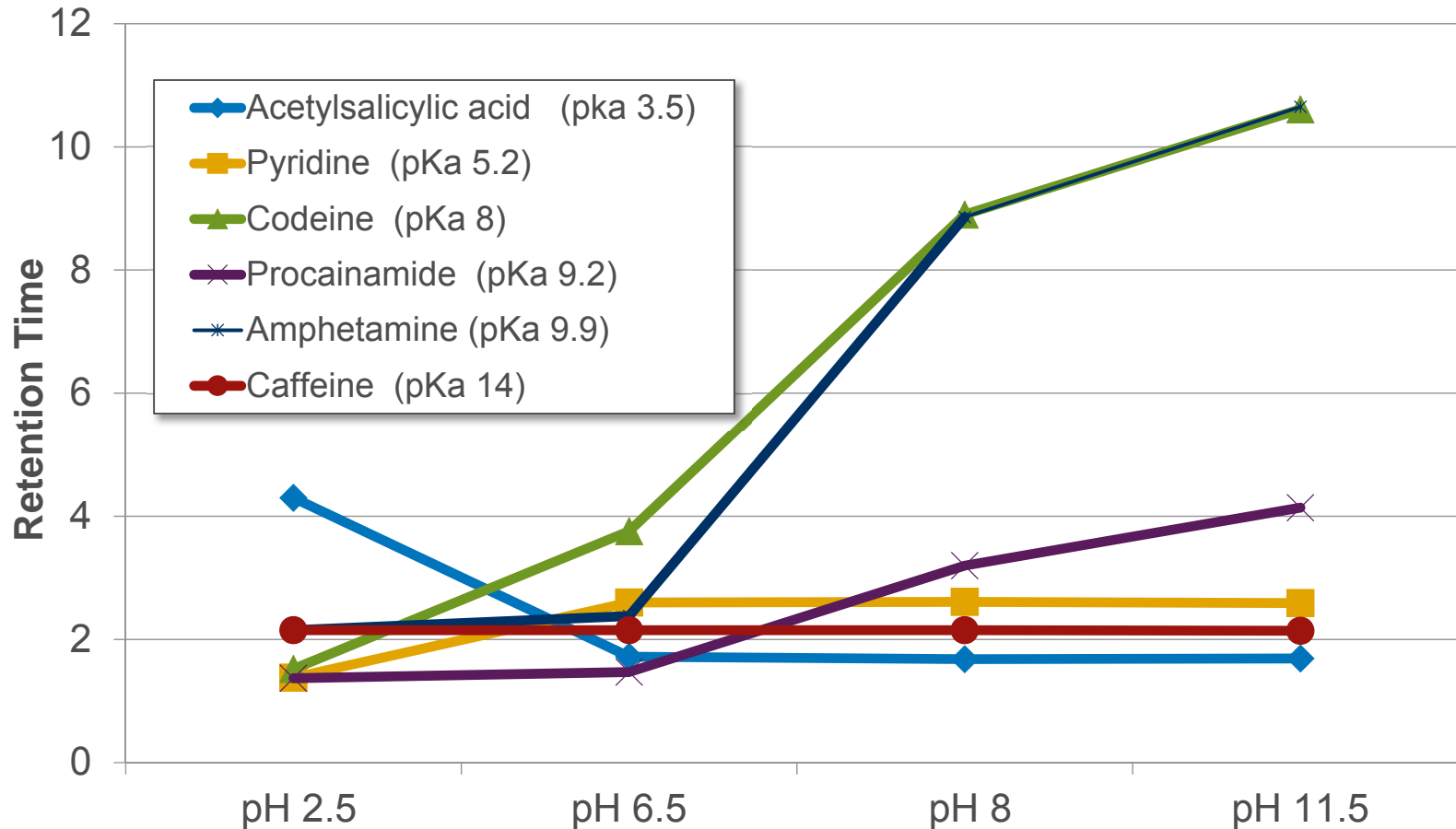

Mobile Phase: 45% MeOH, 55% 20 mM Phosphate Buffer



# pH can Affect Your Separation

Poroshell HPH-C18 4.6 x 50 mm, 2.7  $\mu$ m

Time	% Buffer	% MeCN
0	10	90
5	90	10
7	10	90
2 ml/min		254 mn

1. Procainamide
2. Caffeine
3. Acetyl Salicylic Acid
4. Hexanophenone Deg.
5. Dipyrimadole
6. Diltiazem
7. Diflunisal
8. Hexanophenone

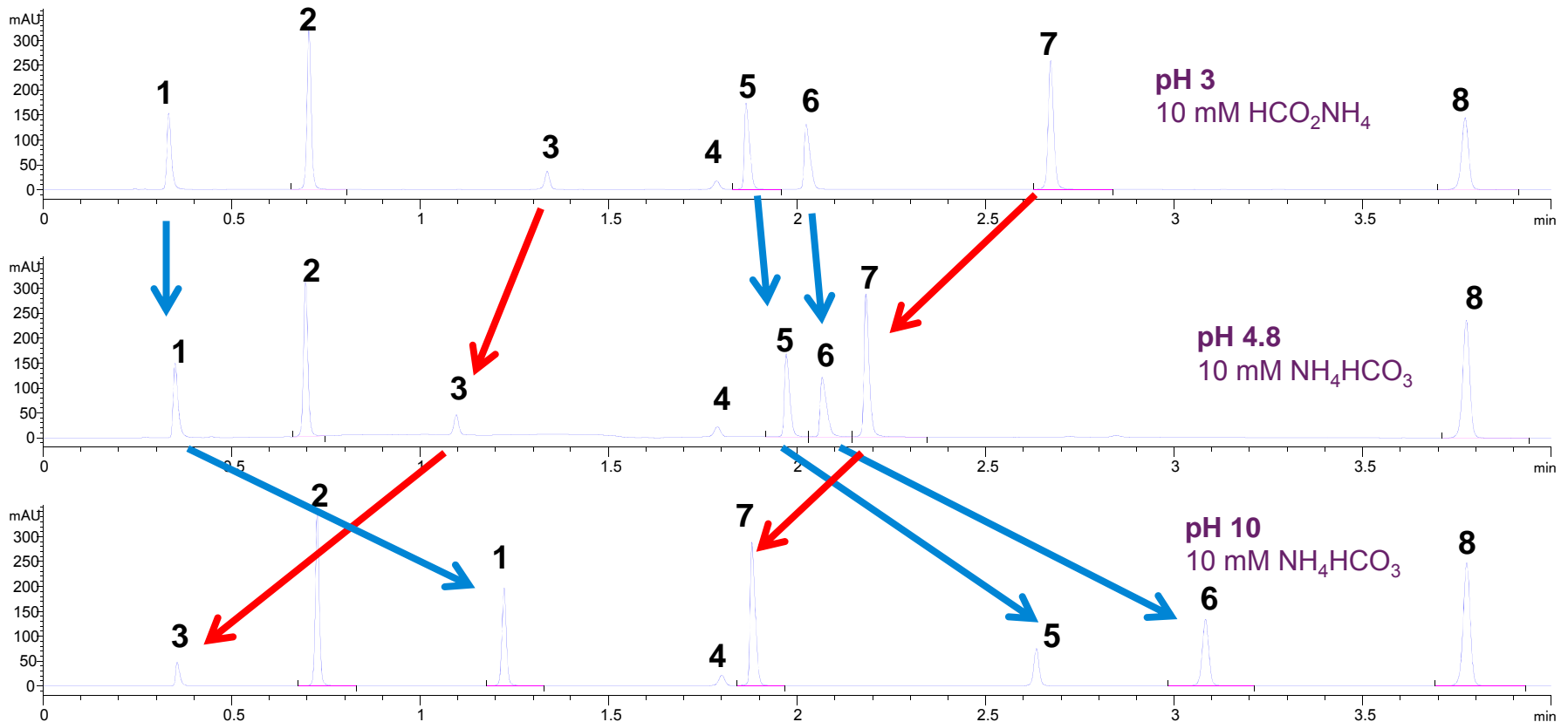

➤ Know if pH affects the retention of your analytes

# Temperature

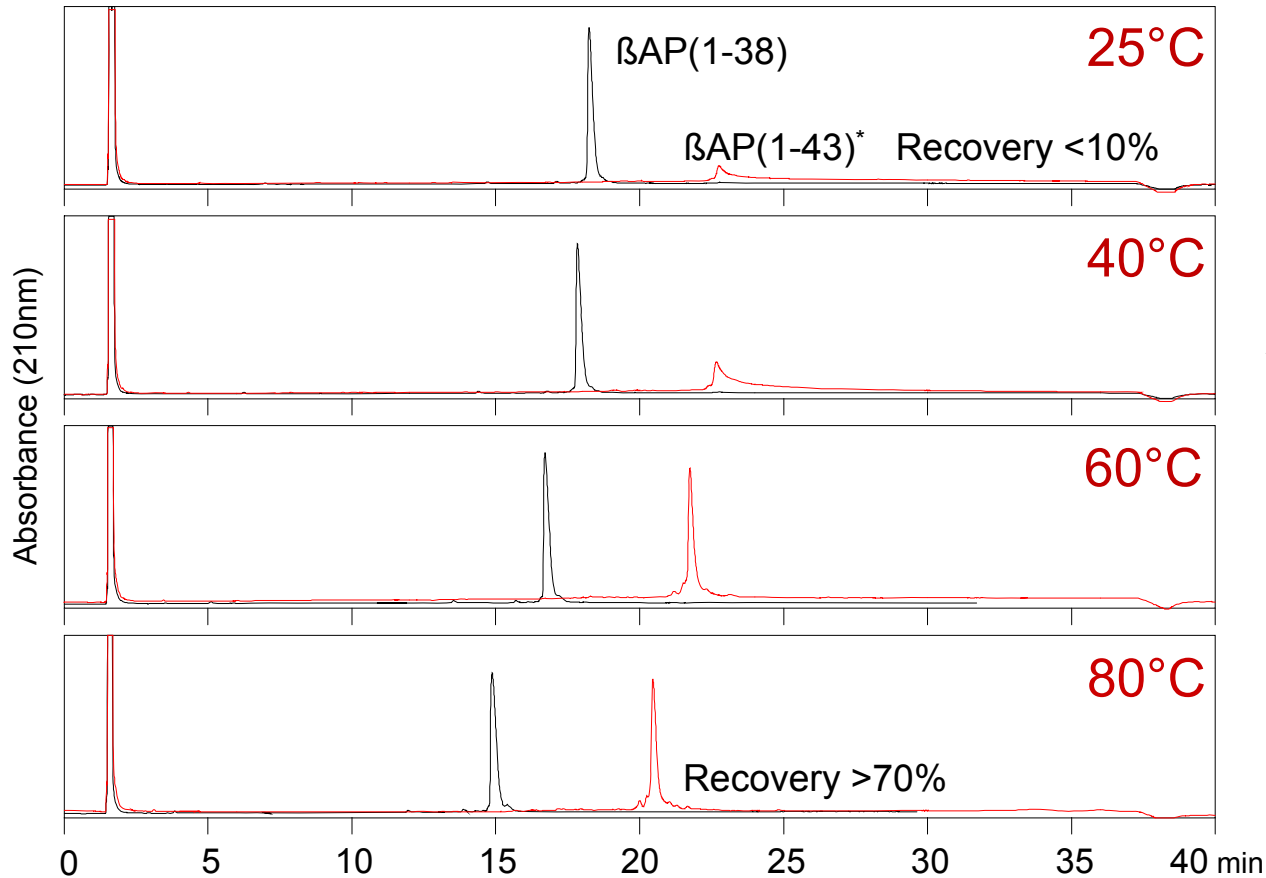

Column: ZORBAX 300 SB-C18, 4.6 x 150 mm

Sample: 10  $\mu$ l injection,  
5  $\mu$ g peptide in 6M Urea/5% HOAc

Conditions: 1 ml/min  
A=0.1%TFA in H<sub>2</sub>O, B=0.09%TFA in ACN  
Gradient: 20-45% B / 35 min

- Changes  $k^*$  and  $\alpha^*$
- Potentially Improves Resolution ( R )
- **Know** if your sample is affected by temperature

# Sample

## Consider the effects of your sample matrix

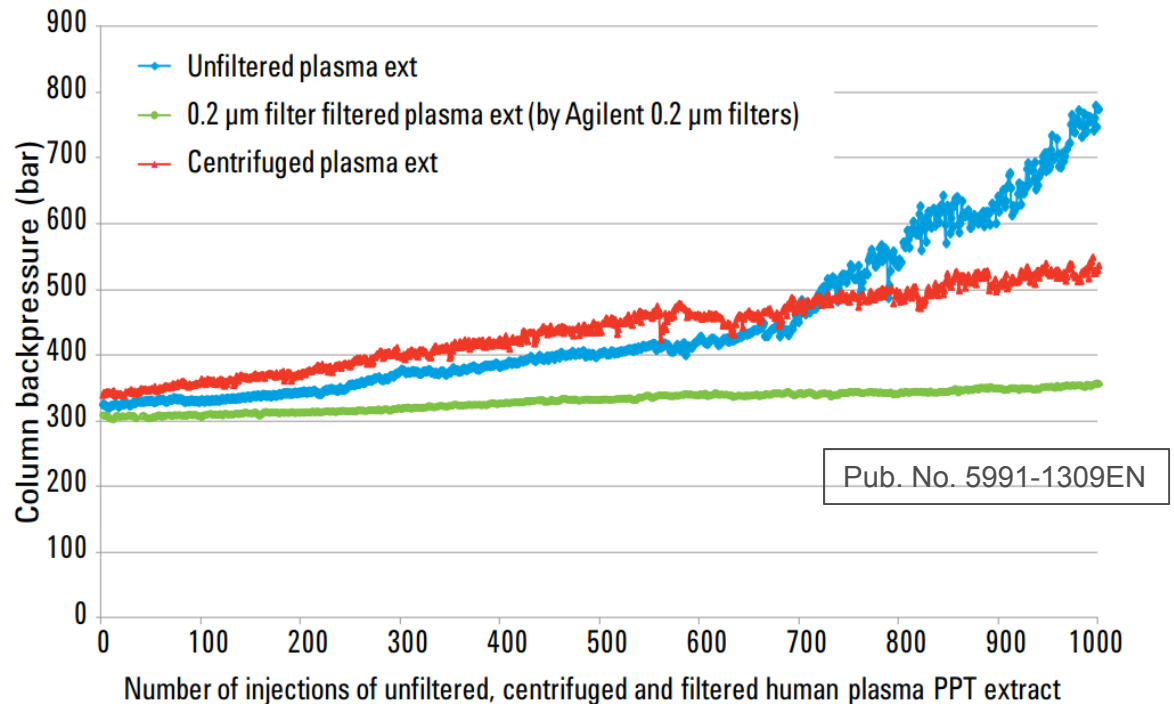

Unfiltered, centrifuged, and filtered plasma extracts  
Zorbax RRHD Eclipse Plus C18, 2.1 x 50 mm, 1.8 µm column, PN 959757-902

- Column plugging is one of the most common sources of LC column failure
- Especially with sub-2 µm columns, sample particulates can easily plug the column inlet frit
- **To help avoid this pitfall, use an appropriate 0.2 µm filter with all samples prior to injection**

<http://filtrationselectiontool.chem.agilent.com>

Captiva Filtration Selection Guide: 5991-1230EN

# Injection Solvent Effects

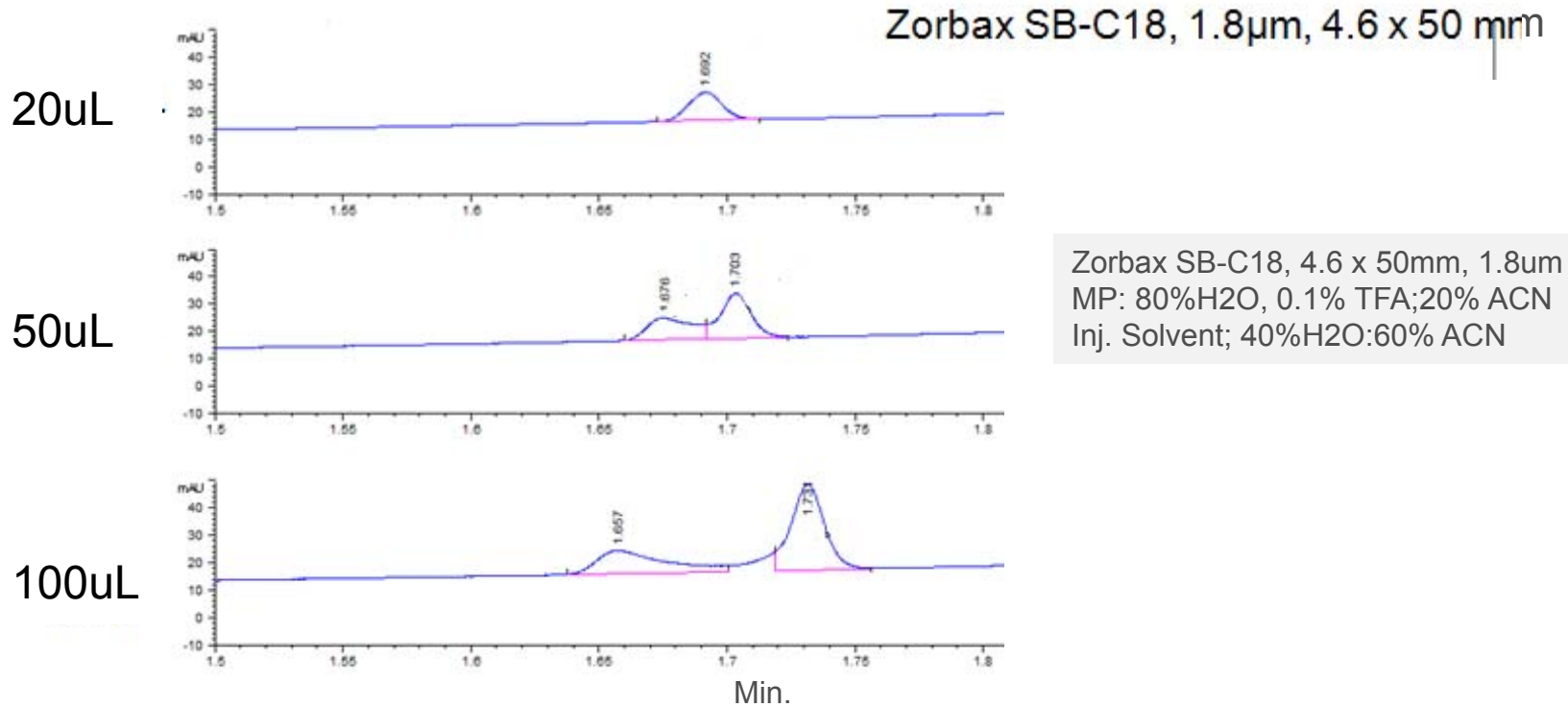

➤ Peak splitting is often observed when injecting a large volume of sample in a solvent that is stronger than the mobile phase

➤ To avoid this pitfall

- When injecting a sample in strong solvent, limit the size of the injection
- Inject the sample in a solvent that is no stronger than the starting conditions for the method

---

# Conclusion

These are just a few of the potential pitfalls which we see fairly regularly.

Have you encountered other pitfalls or do you have an example of one we talked about today? If you have one you'd like to share for a future pitfalls talk, please send it to [lc-column-support@agilent.com](mailto:lc-column-support@agilent.com).

- Avoid Pitfalls -Check out the LC Handbook, Pub# 5990-7595EN

## Thank you!

# Agilent Columns & Supplies Technical Support

800-227-9770 (Toll Free US & Canada)

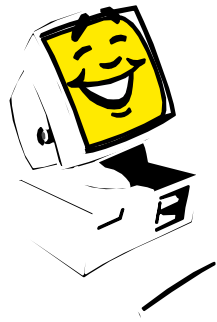

- **For LC columns**
  - *Select option 3, then option 3, option 2*  
[lc-column-support@agilent.com](mailto:lc-column-support@agilent.com)
    - **For GC Columns**
      - *Select option 3, then option 3, option 1*  
[gc-column-support@agilent.com](mailto:gc-column-support@agilent.com)
      - **For Sample Prep**
        - *Select option 3, then option 3, option 3*
    - [spp-support@agilent.com](mailto:spp-support@agilent.com)
    - **For Spectroscopy Supplies**
      - *Select option 3, then option 3, option 4*
- [spectro-supplies-support@agilent.com](mailto:spectro-supplies-support@agilent.com)

[www.agilent.com/chem](http://www.agilent.com/chem)



---

# Appendix

# Information about InfinityLab (A-line) Fittings

Landing page:

[www.agilent.com/chem/A-Line](http://www.agilent.com/chem/A-Line)

Overview flyer (5991-5164EN)

[http://www.agilent.com/cs/library/brochures/5991-5164EN%20A-Line\\_Flyer.pdf](http://www.agilent.com/cs/library/brochures/5991-5164EN%20A-Line_Flyer.pdf)

InfinityLab (A-Line) Fittings  
Technical Overview

<http://www.agilent.com/cs/library/technicaloverviews/public/5991-5525EN.pdf>

Includes ordering info for the fitting, capillaries, and ferrules.  
Kits are available for easy ordering.

Video – how to use the A-Line fittings

A flyer for Agilent A-Line Quick Connect Fittings. The top section features the headline "LESS STRESS MORE RELIABLE CONNECTIONS WITH AGILENT A-LINE SUPPLIES" and a sub-headline "Agilent A-Line Quick Connect Fittings". Below this, there is a section titled "New for all Agilent HPLC and UPLC systems" with a list of bullet points: "Easy finger-tight connection - no special training is needed, no additional tools or steps and no heat gun (chromatography)", "Spring-loaded design - one push and you are done with no connections with IC solvents as easy as pushing a button", "Reliable and reusable - A-Line Quick Connect fittings are long lasting, connect tightly, and are suitable up to 1200 bar (16,000 psi) even after 1000+ connections", and "Fast, easy connections - save time and trouble, consider the standard HPLC with 1200 bar". To the right of the text are images of the fittings and a diagram showing the connection process. At the bottom, there is a section titled "Agilent A-Line Quick Connect Fittings - Order by the Decimeter" with a table of part numbers and descriptions. The Agilent Technologies logo is at the bottom right.



# Replacing capillaries and ferrules

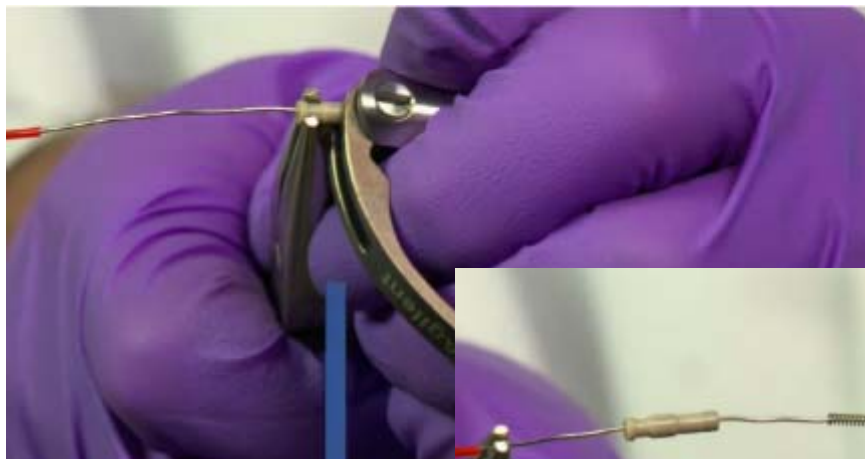

If the capillary is damaged, or another dimension is needed, just use a plier to remove the capillary and insert a new one.



The ferrules can also be replaced; just use pliers to remove the ferrule and insert a new one.



---

# Column Cleaning

Flush with stronger solvents than your mobile phase.

Reversed-Phase Solvent Choices  
in Order of Increasing Strength

Use at least 25 mL of each solvent for analytical columns

- Mobile phase without buffer salts
- 100% Methanol
- 100% Acetonitrile
- 75% Acetonitrile:25% Isopropanol
- 100% Isopropanol
- 100% Methylene Chloride\*
- 100% Hexane\*

\* When using either Hexane or Methylene Chloride the column must be flushed with Isopropanol before returning to your reversed-phase mobile phase.

# Separation Ruggedness

## Buffer Preparation

1. Dissolve salt in organic-free water in 1- or 2-L beaker. Use appropriate volume to leave room for pH adjustment solution. Equilibrate solution to room temperature for maximum accuracy.
2. Calibrate pH meter. Use 2-level calibration and bracket desired pH. Use appropriate audit solution to monitor statistical control (for example, potassium hydrogen tartrate, saturated solution, pH = 3.56).
3. Adjust salt solution to desired pH. Minimize amount of time electrode spends in buffer solution (contamination). Avoid overshoot and readjustment (ionic strength differences can arise).
4. Transfer pH-adjusted buffer solution quantitatively to volumetric flask, dilute to volume, and mix.
5. Filter through 0.45  $\mu\text{m}$  filter. Discard first 50 – 100 mL filtrate. Rinse solvent reservoir with small volume of filtrate and discard. Fill reservoir with remaining filtrate or prepare premix with organic modifier.
  - Agilent Solvent Filtration Kit, 250-mL reservoir, 1000-mL flask, p/n 3150-0577
  - Nylon filter membranes, 47 mm, 0.45  $\mu\text{m}$  pore size, p/n 9301-0895

---

# Using Buffers Successfully

## Initial Column and System Equilibration

In an appropriate vessel, test highest % organic/buffer ratio to verify that buffer will not precipitate. With stirring, add organic to buffer first, not vice versa.

Equilibrate column with, in order:

- 100% organic modifier (if brand new)
- mobile phase minus buffer
- buffered mobile phase containing highest % organic modifier (gradient high end)
- buffered mobile phase containing lowest % organic modifier (gradient low end).

Inject standard or sample several times until RTs stable, or for gradient methods, precede former with 1 or 2 blank gradients.

---

# Using Buffers Successfully

## Shutdown State and Instrument Flushing

### Shutdown State

Next day use—using same buffers

- Pump mobile phase very slowly (for example, 0.01 – 0.1 mL/min).

When flushing column or for longer term column storage

- Flush with 20/80 organic/water, then 80/20 organic/water or 100% organic.

### Instrument flushing

Replace column with capillary tubing. Leave disconnected from detector.

Flush pumps with water, then connect capillary tubing to detector.

Inject water 2-3 times at maximum injection volume setting.

Flush all pumps with 100% organic for long term storage.

# Method Validation Kits

Agilent ZORBAX Rapid Resolution High Definition (RRHD) Method Validation Kits											
Size (mm)	Particle Size (µm)	Eclipse Plus C18	Eclipse Plus C8	Eclipse XDB-C18	Extend-C18	Eclipse Plus Phenyl-Hexyl	Bonus-RP	SB-C18	SB-C8	SB-Phenyl	SB-Aq
3.0 x 150	1.8	959759-302K	959759-306K	981759-302K				859700-302K	859700-306K		
3.0 x 100	1.8	959758-302K	959758-306K	981758-302K	758700-302K	959758-312K		858700-302K	858700-306K	858700-312K	858700-314K
3.0 x 50	1.8	959757-302K	959757-306K	981757-302K	757700-302K	959757-312K		857700-302K	857700-306K	857700-312K	857700-314K
2.1 x 150	1.8	959759-902K	959759-906K	981759-902K	759700-902K	959759-912K	859768-901K	859700-902K	859700-906K	859700-912K	859700-914K
2.1 x 100	1.8	959758-902K	959758-906K	981758-902K	758700-902K	959758-912K	858768-901K	858700-902K	858700-906K	858700-912K	858700-914K
2.1 x 50	1.8	959757-902K	959757-906K	981757-902K	757700-902K	959757-912K	857768-901K	857700-902K	857700-906K	857700-912K	857700-914K

Agilent ZORBAX Method Validation Kits													
Size (mm)	Particle Size (µm)	Eclipse Plus C18	Eclipse Plus C8	Eclipse XDB-C18	Eclipse XDB-C8	Extend-C18	Eclipse Plus Phenyl-Hexyl	Bonus-RP	SB-Aq	SB-C18	SB-C8	SB-Phenyl	
4.6 x 250	5	959990-902K	959990-906K	990967-902K	990967-906K	770450-902K	959990-912K	880668-901K	880975-914K	880975-902K	880975-906K	880975-912K	
4.6 x 150	5	959993-902K	959993-906K	993967-902K	993967-906K	773450-902K		883668-901K	883975-914K	883975-902K	883975-906K	883975-912K	
3.0 x 150	5	959993-302K											
4.6 x 250	3.5										884950-567K		
4.6 x 150	3.5	959963-902K	959963-906K	963967-902K	963967-906K	763953-902K	959963-912K	863668-901K	863953-914K	863953-902K	863953-906K	863953-912K	
4.6 x 100	3.5	959961-902K	959961-906K	961967-902K	961967-906K	764953-902K	959961-912K	864668-901K	861953-914K	861953-902K	861953-906K	861953-912K	
4.6 x 50	3.5	959943-902K	959943-906K	935967-902K	935967-906K	735953-902K	959943-912K	835668-901K	835975-914K	835975-902K	835975-906K	835975-912K	
4.6 x 150	1.8	959994-902K											
4.6 x 100	1.8	959964-902K	959964-906K	928975-902K	928975-906K	728975-902K	959964-912K	828668-901K	828975-914K	828975-902K	828975-906K	828975-912K	
4.6 x 50	1.8	959941-902K	959941-906K	927975-902K	927975-906K	727975-902K	959941-912K	827668-901K	827975-914K	827975-902K	827975-906K	827975-912K	
3.0 x 100	1.8					928975-306K		828668-301K					
3.0 x 50	1.8					927975-306K		827668-301K					
2.1 x 100	1.8					928700-906K							
2.1 x 50	1.8					927700-906K							

Agilent Poroshell 120 Method Validation Kits								
Size (mm)	Particle Size (µm)	EC-C18	EC-C8	Phenyl-Hexyl	SB-C18	SB-C8	SB-Aq	Bonus-RP
4.6 x 150	2.7	693975-902K	693975-906K	693975-912K	683975-902K	683975-906K	683975-914K	693968-901K
4.6 x 100	2.7	695975-902K	695975-906K	695975-912K	685975-902K	685975-906K	685975-914K	695968-901K
4.6 x 50	2.7	699975-902K	699975-906K	699975-912K	689975-902K	689975-906K	689975-914K	699968-901K
3.0 x 150	2.7	693975-302K	693975-306K	693975-312K	683975-302K	683975-306K	683975-314K	693968-301K
3.0 x 100	2.7	695975-302K	695975-306K	695975-312K	685975-302K	685975-306K	685975-314K	695968-301K
3.0 x 50	2.7	699975-302K	699975-306K	699975-312K	689975-302K	689975-306K	689975-314K	699968-301K
2.1 x 150	2.7	693775-902K	693775-906K	693775-912K	683775-902K	683775-906K	683775-914K	693768-901K
2.1 x 100	2.7	695775-902K	695775-906K	695775-912K	685775-902K	685775-906K	685775-914K	695768-901K
2.1 x 50	2.7	699775-902K	699775-906K	699775-912K	689775-902K	689775-906K	689775-914K	699768-901K

# Method Development Kits

PN	MD Kits	Description
5190-6160	<b>P120, USP Method Dev Kit, 3.0x100mm</b>	Poroshell 120 EC-C18, EC-C8, EC-CN columns, 3.0 x 100 mm
5190-6159	<b>P120, USP Method Dev Kit, 4.6x100mm</b>	Poroshell 120 EC-C18, EC-C8, EC-CN columns, 4.6 x 100 mm
5190-6155	<b>P120, Selectivity Meth Dev, 2.1x50mm</b>	Poroshell 120 EC-C18, Phenyl-Hexyl, Bonus RP columns, 2.1 x 50 mm
5190-6156	<b>P120, Selectivity Meth Dev, 4.6x50mm</b>	Poroshell 120 EC-C18, Phenyl-Hexyl, Bonus RP columns, 4.6 x 50 mm
5190-6157	<b>P120, Aqueous Meth Dev Kit, 2.1x50mm</b>	Poroshell 120 Sb-Aq, Phenyl-Hexyl, Bonus RP columns, 2.1 x 50 mm
5190-6158	<b>P120, Aqueous Meth Dev Kit, 4.6x50mm</b>	Poroshell 120 SB-Aq, Phenyl-Hexyl, and Bonus RP columns, 4.6 x 50 mm
5190-6153	<b>RRHD Eclipse Plus Meth Dev Kit, 2.1mm ID</b>	RRHD Eclipse Plus C18, Eclipse Plus C8, Eclipse Plus Phenyl-Hexyl, 2.1 x 50 mm columns
5190-6154	<b>RRHD Aqueous Method Dev Kit, 2.1mm ID</b>	RRHD SB-Aq, Bonus RP, and Eclipse Plus Phenyl-Hexyl column, 2.1 x 50 mm
5190-6152	<b>RRHD pH Method Dev Kit, 2.1mm ID</b>	RRHD StableBond SB-C18, Eclipse Plus C18, and Extend-C18 column, 2.1 x 50 mm
5190-6160	<b>P120, USP Method Dev Kit, 3.0x100mm</b>	Poroshell 120 EC-C18, EC-C8, EC-CN columns, 3.0 x 100 mm
5190-6159	<b>P120, USP Method Dev Kit, 4.6x100mm</b>	Poroshell 120 EC-C18, EC-C8, EC-CN columns, 4.6 x 100 mm
5190-6155	<b>P120, Selectivity Meth Dev, 2.1x50mm</b>	Poroshell 120 EC-C18, Phenyl-Hexyl, Bonus RP columns, 2.1 x 50 mm
5190-6156	<b>P120, Selectivity Meth Dev, 4.6x50mm</b>	Poroshell 120 EC-C18, Phenyl-Hexyl, Bonus RP columns, 4.6 x 50 mm
5190-6157	<b>P120, Aqueous Meth Dev Kit, 2.1x50mm</b>	Poroshell 120 Sb-Aq, Phenyl-Hexyl, Bonus RP columns, 2.1 x 50 mm