

Two-Dimensional Liquid Chromatography for Small Molecule Pharmaceutical Analysis - More Knowledge in Less Time

Qinggang Wang, Yehia Baghdady, Ziqing Lin, Hui Lin, Johnathan Shackman,
Brian He, Yiyang Zhou, Catherine Miles and Lianjia Ma

Chemical Process Development
Bristol Myers Squibb

Outline

- Introduction
- 2D-LC applications in BMS for small molecule pharmaceutical analysis
 - 2D-LC peak purity check
 - Quantitative 2D-LC Impurity analysis
 - Trapping mode 2D-LC
- Summary

Introduction

- Pharmaceutical companies have been under consistent pressure to bring safe therapeutics to patients faster.
- The structural complexity of synthetic drug candidates has been increasing in the pharmaceutical development pipeline, and complete separation of all relevant peaks can be challenging in LC method development. This is especially true during early-stage process development, when the knowledge of process impurities is still limited.
- These challenges have prompted the evolution of innovative analytical techniques to facilitate knowledge generation in chemical process development.

Effect of Technology Innovation

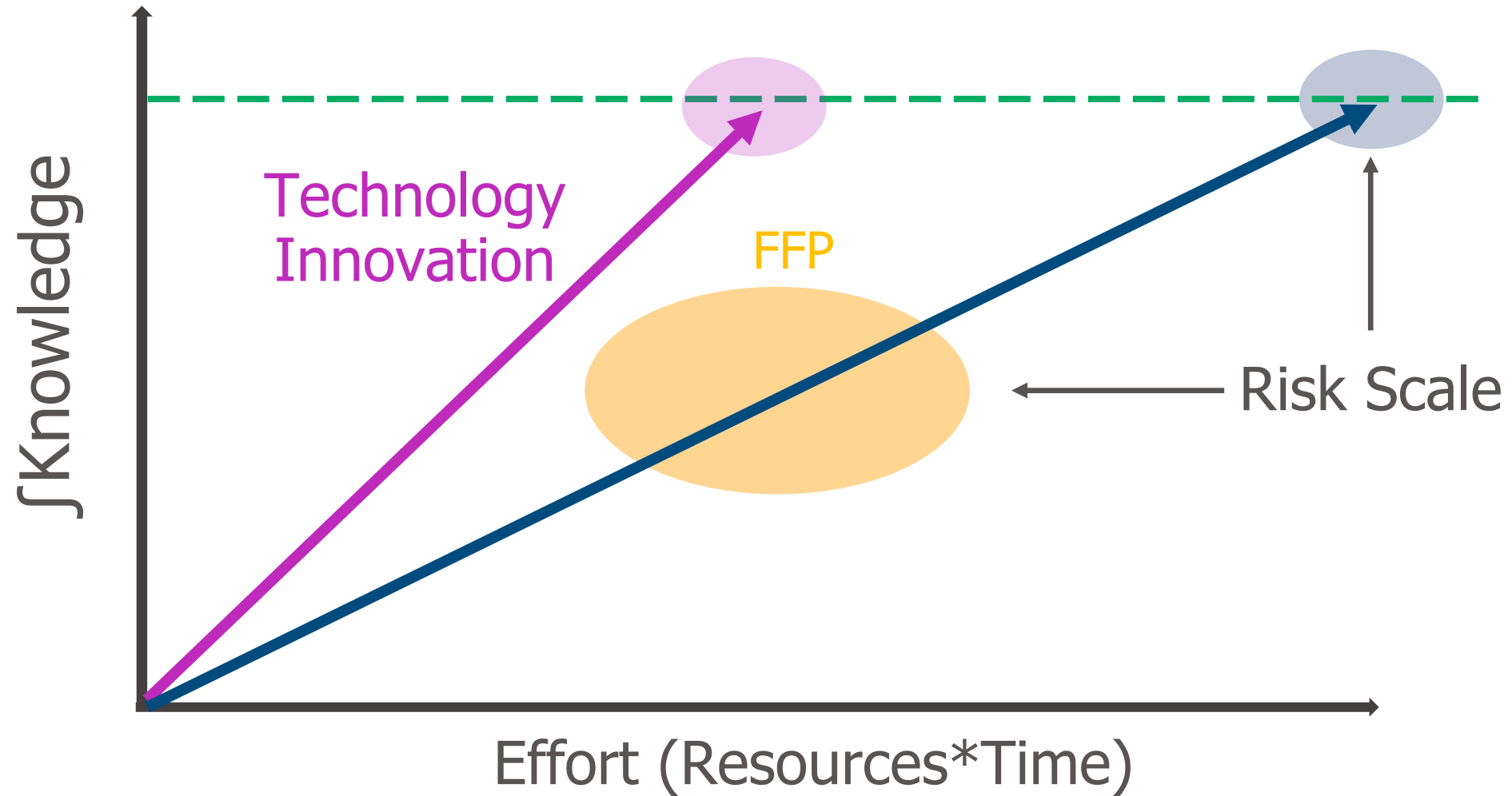

2D-LC Evolution

- Compared with conventional 1D-LC, 2D-LC can significantly improve separation power through unique selectivity pairings.
- 2D-LC has grown rapidly in both practical and theoretical aspects in the last few decades. There are ~ 800 publications on 2D-LC since 2000, of which over 200 are published in the last four years.
- Significant progress has been made to address technical challenges with 2D-LC such as solvent mis-match, limitation on ²D cycle time, ²D sensitivity, complexity in both hardware and software.
- Turnkey commercial instruments are now available from multiple vendors.

Outline

- Introduction
- 2D-LC applications in BMS for small molecule pharmaceutical analysis
 - 2D-LC peak purity check
 - Quantitative 2D-LC analysis
 - Trapping mode 2D-LC
- Summary

Method Specificity/Selectivity

- **Impurity control for pharmaceutical compounds is critical for patient safety**
 - **Known knowns:** Identified impurities separated from the main
 - **Unknown knowns:** Un-identified impurities separated from the main
 - **Known unknowns:** Identified impurities not separated from the main
 - **Unknown unknowns:** Un-identified impurities not separated from the main
- Existing peak purity check tools, such as MS and PDA, have limitations, and are generally not very sensitive to low level impurities.
- Comprehensive column/mobile phase screening is a very powerful tool, but usually very time consuming (long run time and complicated process for impurity tracking).
- 2D-LC, combining with PDA and MS, can greatly improve confidence on detection of “unknown unknowns”.

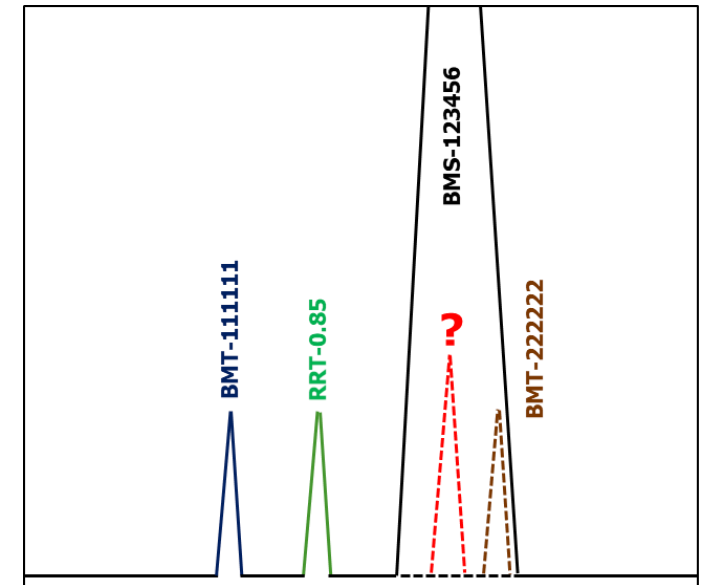

2D-LC Peak Purity Check Workflow (Version 1)

- Use the existing HPLC method as the first dimension (¹D LC).
- For the second dimension (²D LC), select orthogonal columns using **HSM** with on-line column database (<http://www.hplccolumns.org>).
- Change organic solvents between **acetonitrile** or **acetonitrile with 20% methanol**.
- Change mobile phase (MP) pH between **acidic (0.05% TFA)** and neutral (**10 mM NH₄OAc**).
- Keep the other method conditions the same as 1D-LC.

Identify Orthogonal LC Conditions

¹D LC

Column: **Ascentis Express C18** (2.1 x 150 mm, 2.7 μm)

MPA: 10 mM NH₄OAc in Water: **MeCN** (90:10)

MPB: 10 mM NH₄OAc in Water: **MeCN** (10:90)



²D LC

Column: **Zorbax Bonus-RP** (2.1 x 100 mm, 1.8 μm)

MPA: Water: **MeOH** (80:20) with 0.1% TFA

MPB: Water: **MeOH: MeCN** (10:20:70) with 0.1% TFA

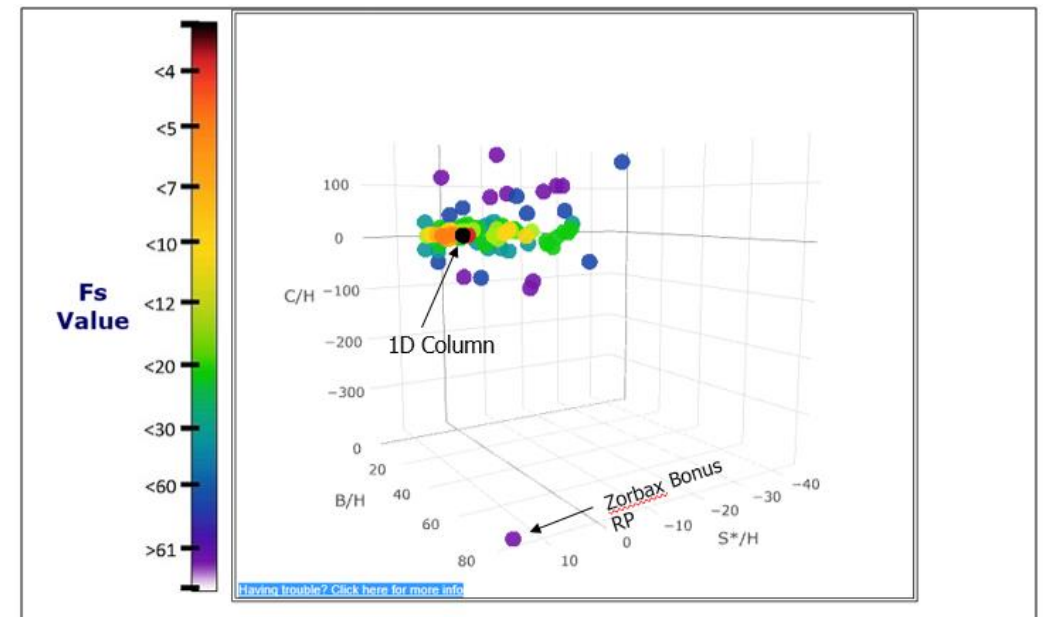
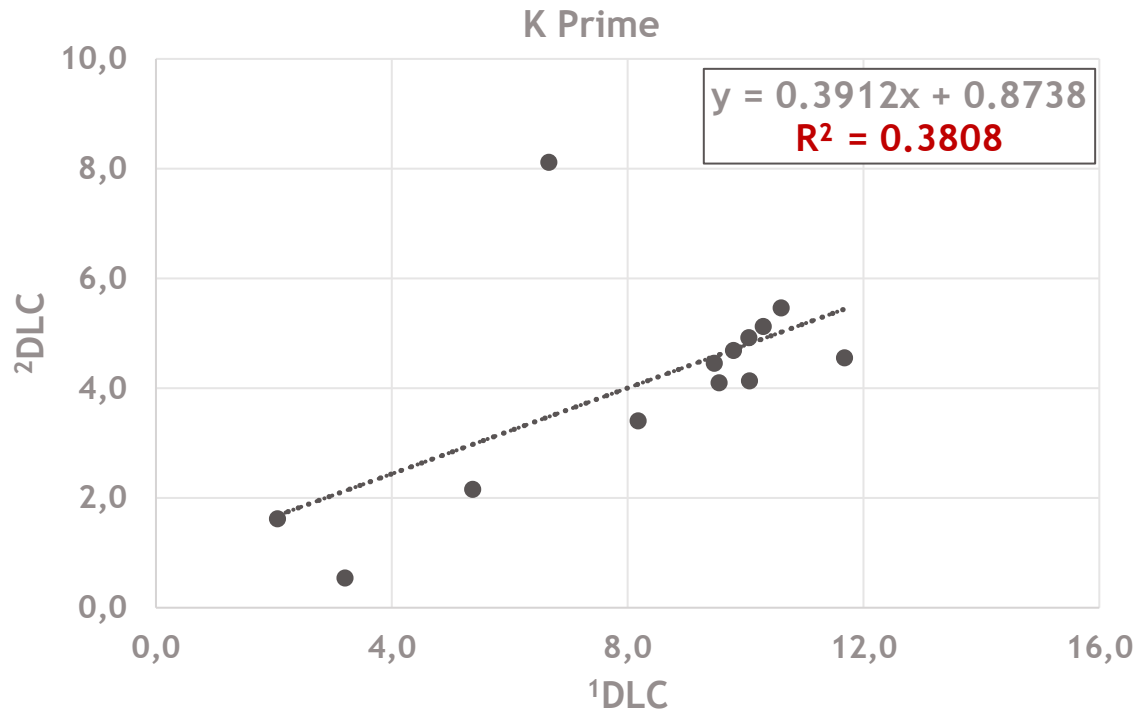

2D-LC Peak Purity Check Performance Evaluation

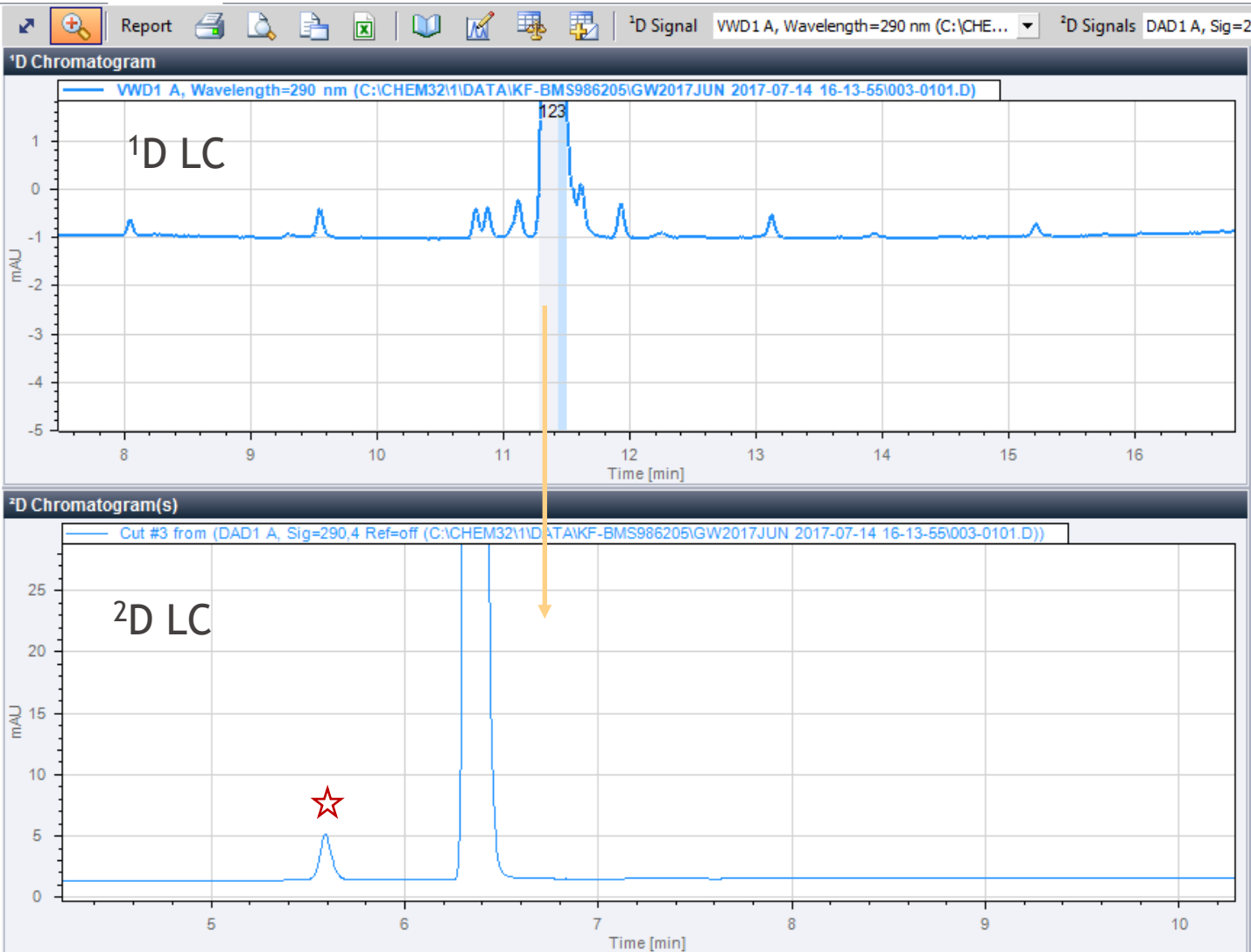

- Co-eluting impurity in ¹D LC was separated in ²D LC.
- No efficiency loss was observed.
- Sensitivity of ²D LC at 0.1AP could be achieved.

2D-LC-MS Peak Purity Check - an Example

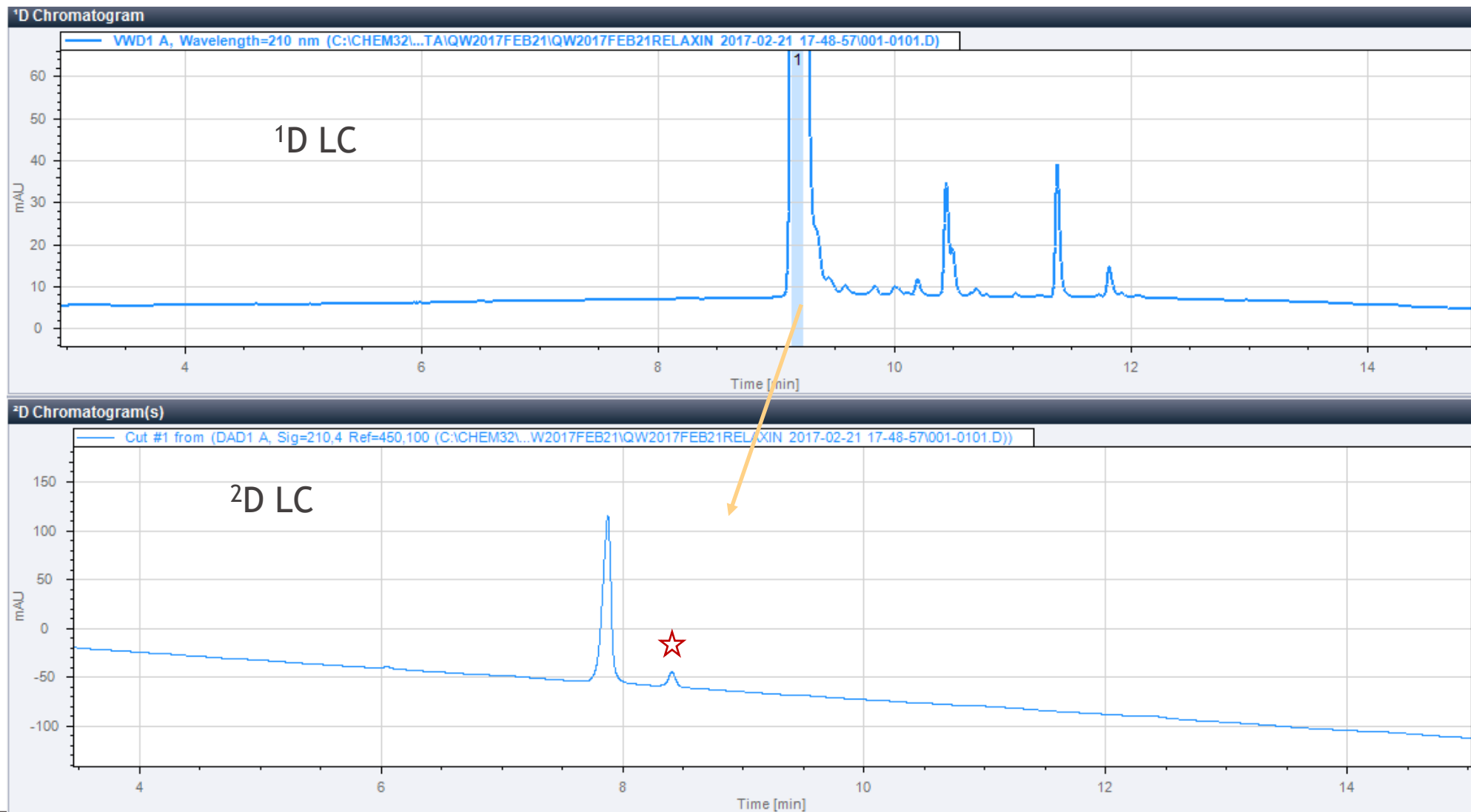

2D-LC-MS Peak Purity Check - an Example

Mass Spectra and UV Spectra of Main Peak and Impurity

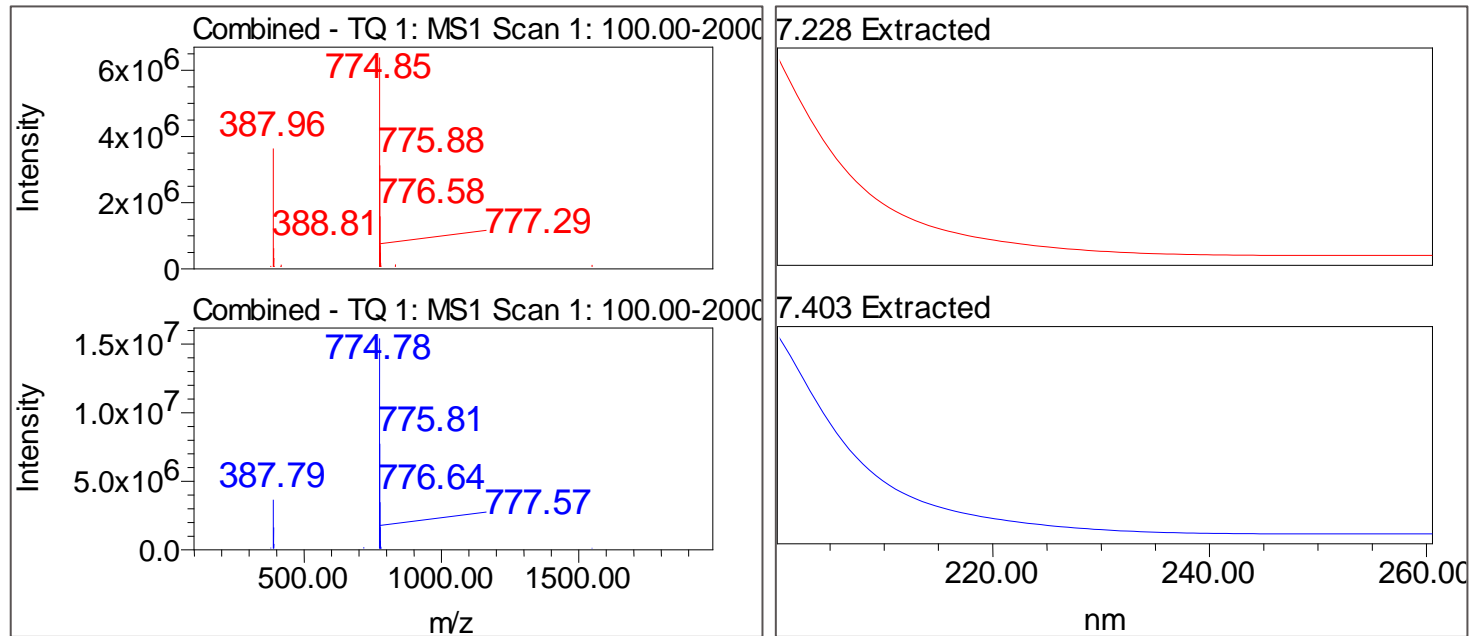

- Co-eluting isomeric impurity cannot be detected by PDA or MS

Top: Co-eluting isomeric impurity; Bottom: Main peak

2D-LC-MS Peak Purity Check Workflow (Version 4)

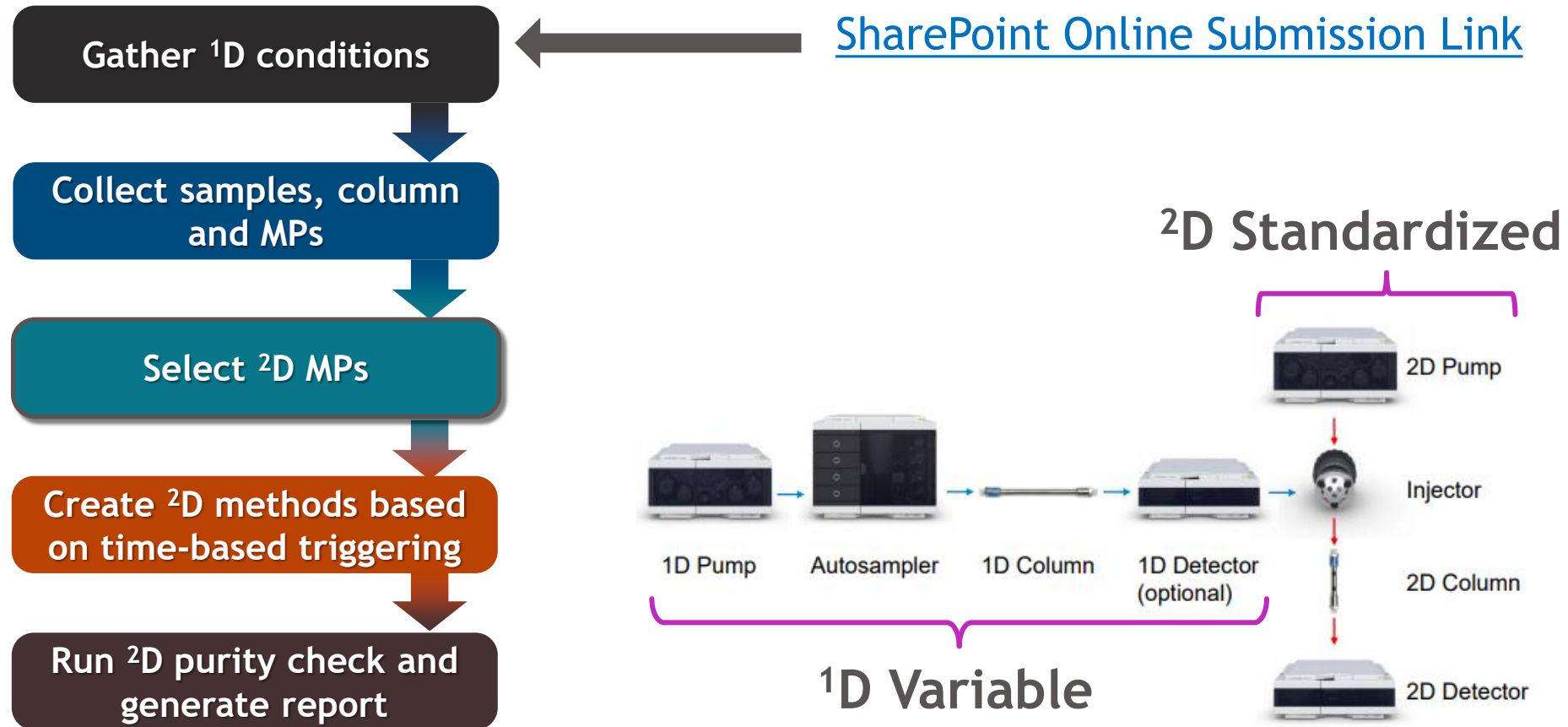

Standardized ²D LC Conditions

²D MP selection based on ¹D MPs:

¹ D MPs	² D MP Selection
MeCN only, pH ≤ 4	MeCN w/ MeOH, neutral
MeCN only, pH > 4	MeCN w/ MeOH, acidic
MeCN w/ MeOH or MeOH only, pH ≤ 4	MeCN only, neutral
MeCN w/ MeOH or MeOH only, pH > 4	MeCN only, acidic

²D Columns:

Valve Position	Column Description
1	Zorbax Bonus RP, 4.6×100 mm, 1.8 μm
2	Ascentis Express F5, 4.6×100 mm, 2.7 μm
3	Halo Biphenyl, 4.6×100 mm, 2.7 μm
4	Chiralpak IG-3, 4.6×100 mm, 3 μm
5	Waters HSS C18 SB, 4.6x100 mm, 1.8 μm
6	By-pass

Gradient:

Time	%A	%B
0.00	100.0	0.0
1.00	100.0	0.0
16.00	0.0	100.0
17.00	0.0	100.0

Other LC Conditions:

Flow Rate:	1.0 mL/min
Column Temperature:	40 °C
UV Wavelength:	Same as ¹ D
MS:	Full Scan

Overcoming Technical Challenges for Routine Use

Generic 2DLC system suitability test (SST) to verify if the 2DLC instrument functions properly

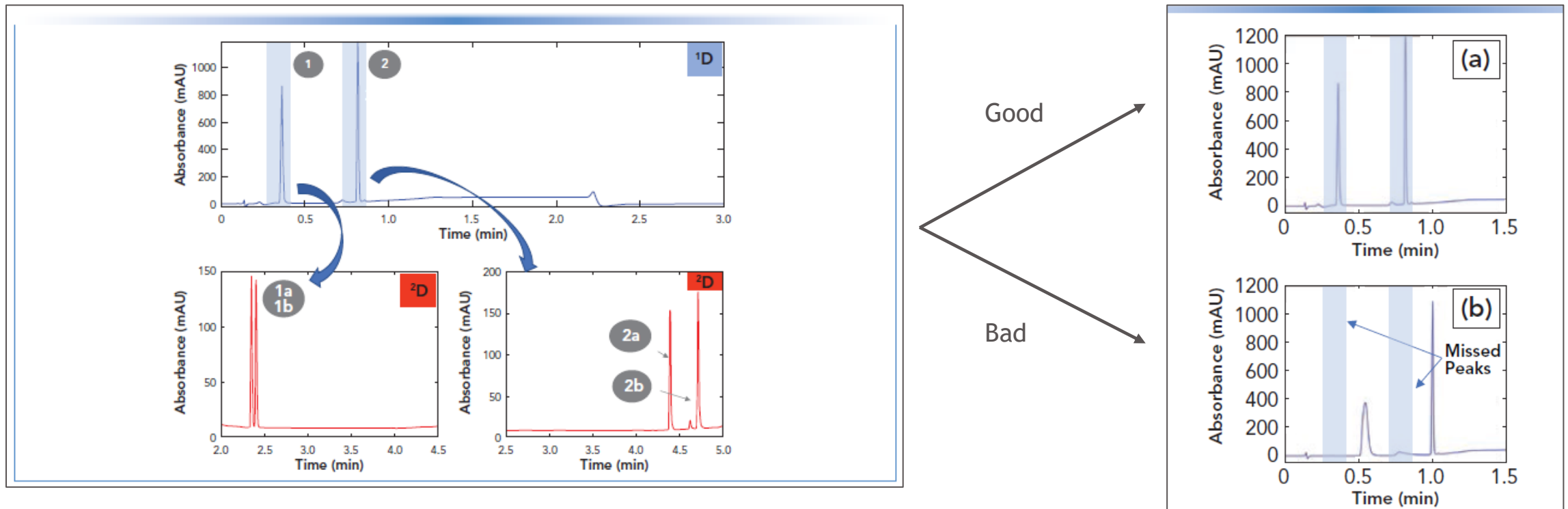

Baghdady YZ, Stoll DR, LCGC, 2022, 40:292

Overcoming Technical Challenges for Routine Use

Complete 1D peak coverage

- Large loop size (120-180 μL to replace 40 μL default)
- Multi-Injection feature with new OpenLab CDS software
- Maximize ASM factor (0.12x85 mm ASM capillary, ASM ratio: 5)
- Start gradient with low solvent strength (0-5%)

Overcoming Technical Challenges for Routine Use

Detect false positive (In-loop degradation)

- Repeat ²D LC with 1D-LC-MS to confirm co-elution
- Understand sample stability
 - Repeat 1D-LC with longer initial gradient holding time
 - Multi-injection with OpenLab CDS

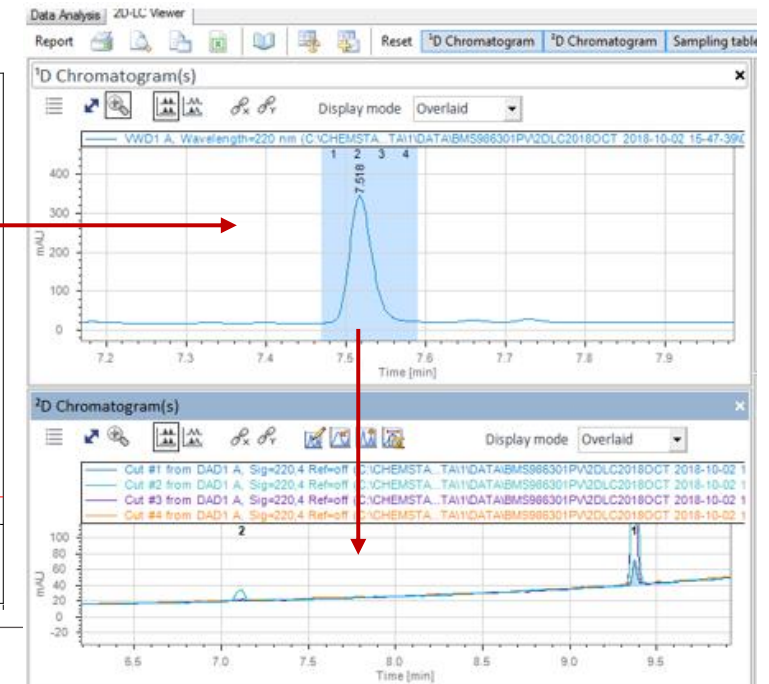
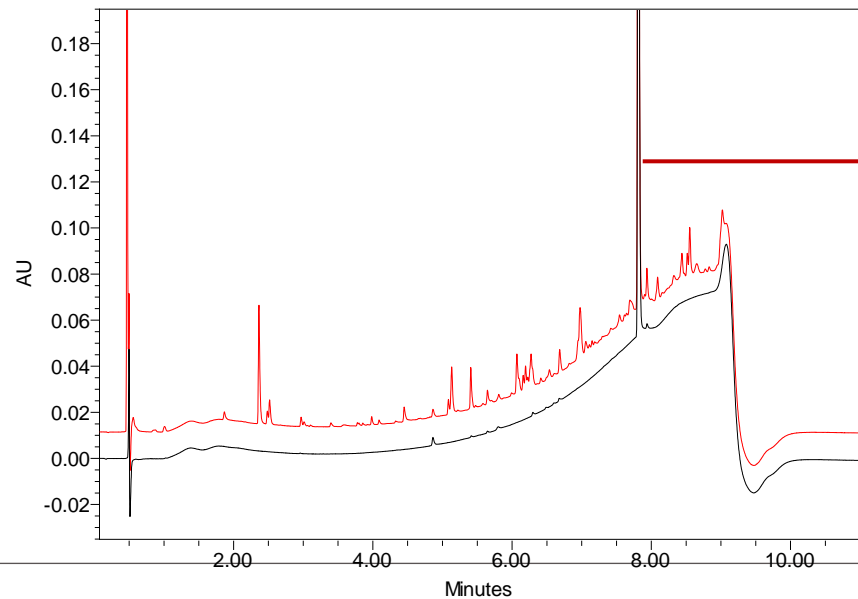

Outline

- Introduction
- 2D-LC applications in BMS for small molecule pharmaceutical analysis
 - 2D-LC peak purity check
 - Quantitative 2D-LC analysis
 - Trapping mode 2D-LC
- Summary

2D-LC Quantitative Impurity Analysis

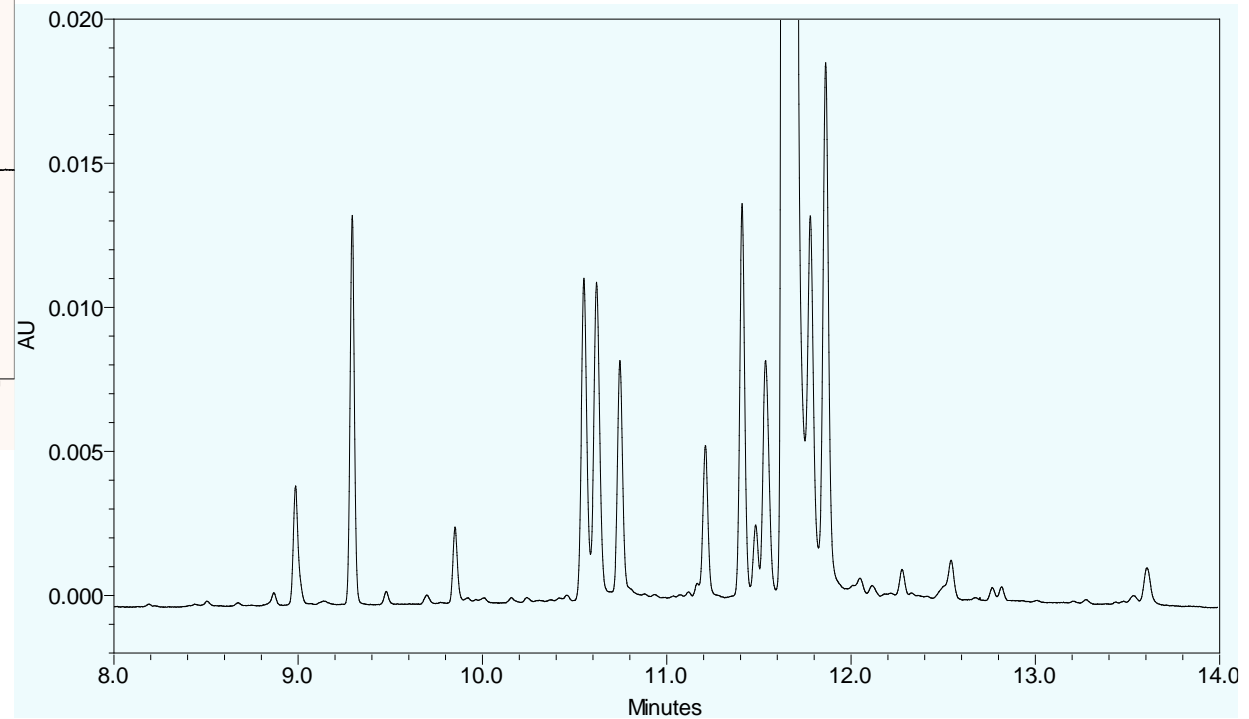
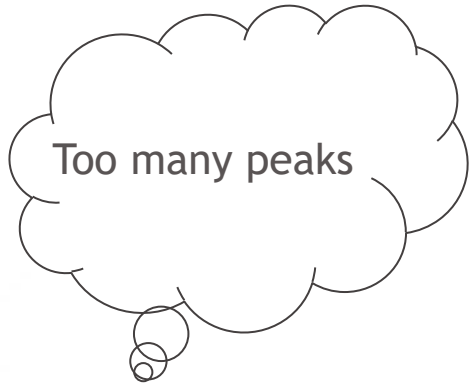
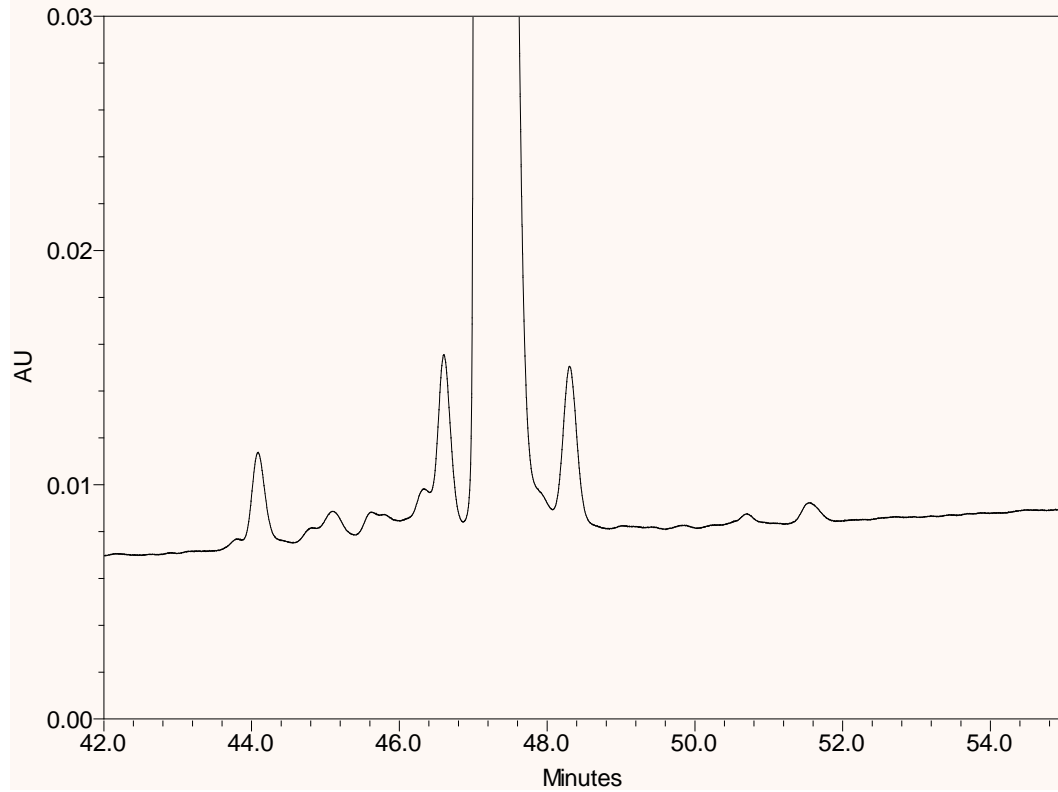

2D-LC Quantitative Impurity Analysis - an Example

- The test molecule, BMS-986142, contains two rotational axes which results in three potential atropisomeric impurities (IMP1, IMP2 and IMP3).
- Separation of BMS-986142 from these impurities by achiral LC was very challenging. Three atropisomeric impurities can only be partially resolved from each other and BMS-986142.

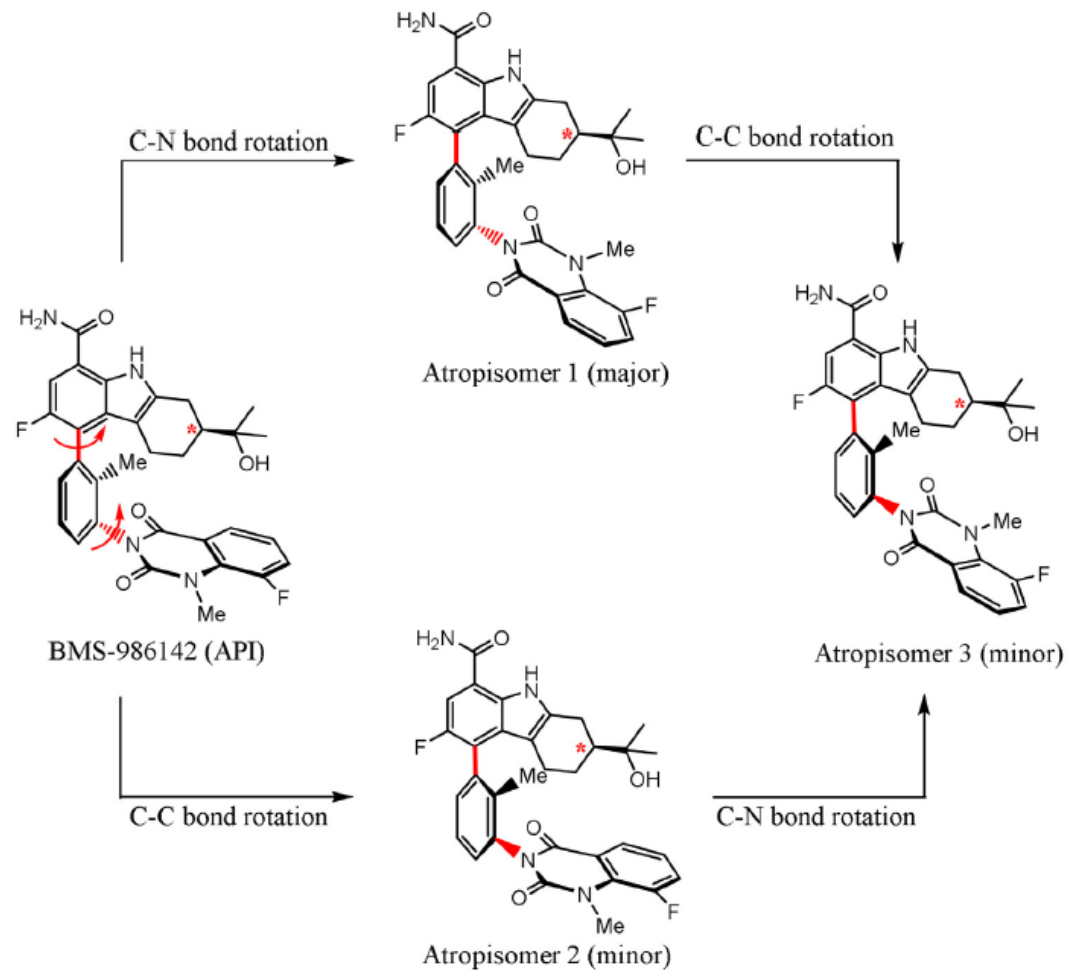

Wang Q, He B, Shackman J, JPBA, 2021, 193:113730

Chromatographic Conditions

¹D LC

²D LC

Column: **BEH Shield RP18** (100x2.1 mm, 1.7 μm)

MPA: 10 mM NH₄HCOO, pH 3

MPB: MeOH:MeCN 30:70

Gradient: 0/30/35 min, 40/65/80 %B

Flow rate: 0.2 mL/min

Detection: 320 nm

Column: **Pinnacle DB BiPh** (150x4.6 mm, 3 μm)

MPA: 10 mM NH₄HCOO, pH 3

MPB: MeOH

Gradient: 0/40 min, 60/90 %B

Flow rate: 0.6 mL/min

Detection: 320 nm

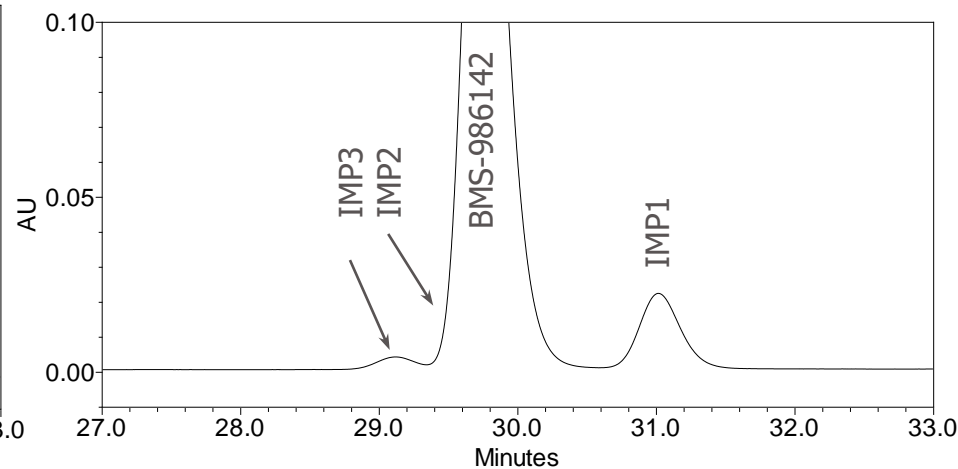
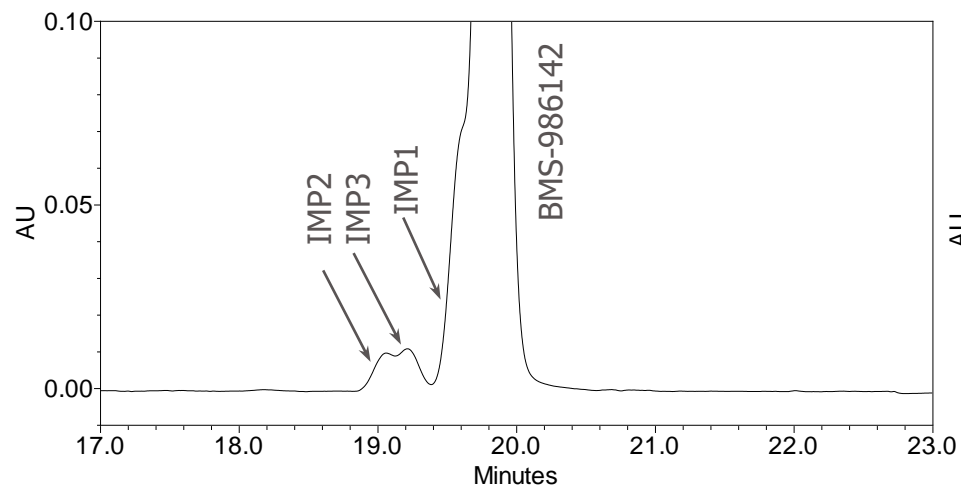

Wang Q, He B, Shackman J, JPBA, 2021, 193:113730

2D-LC with High Resolution Sampling

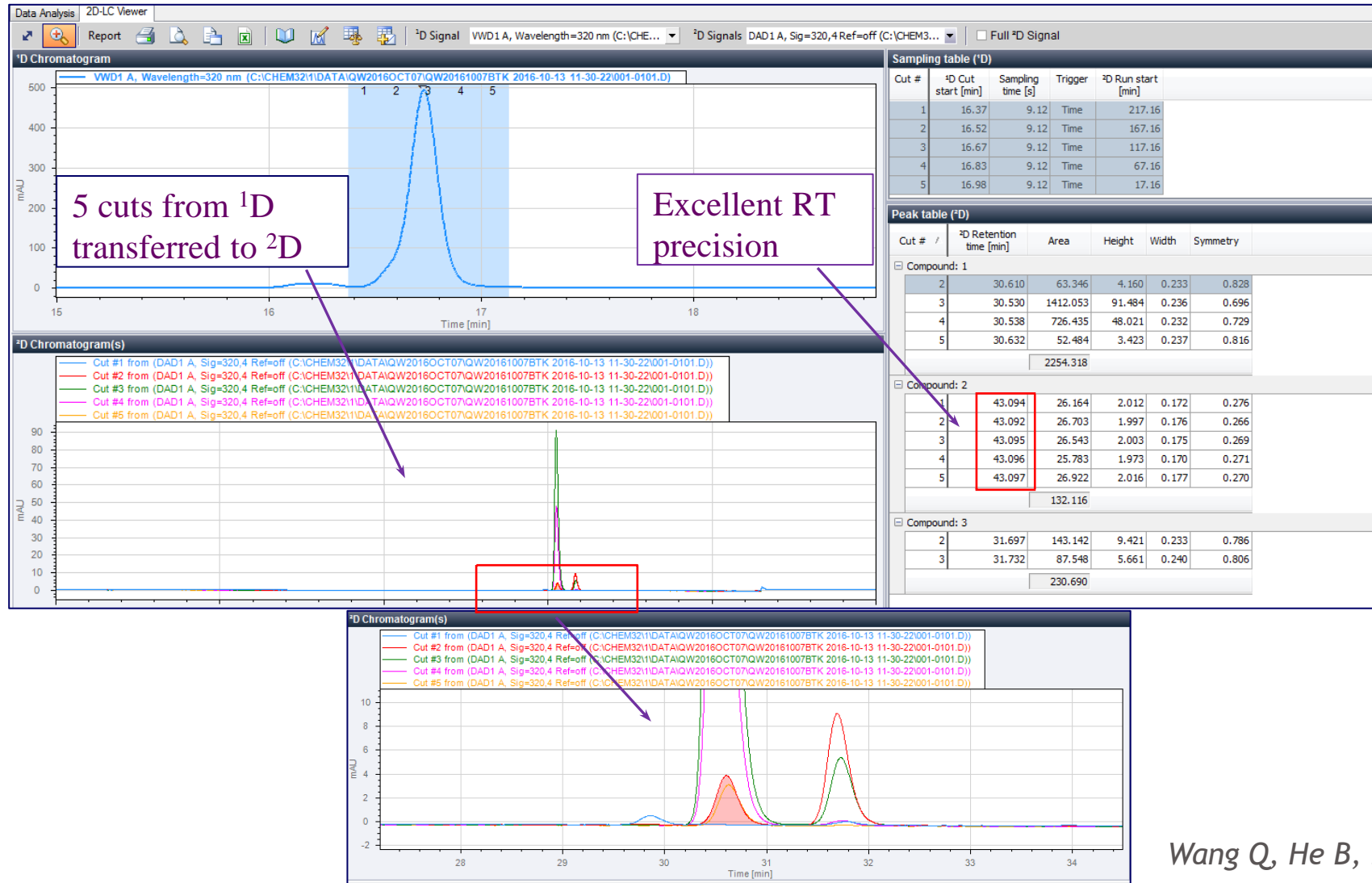

Wang Q, He B, Shackman J, JPBA, 2021, 193:113730

2D-LC with High Resolution Sampling

- **Quantitative Results**

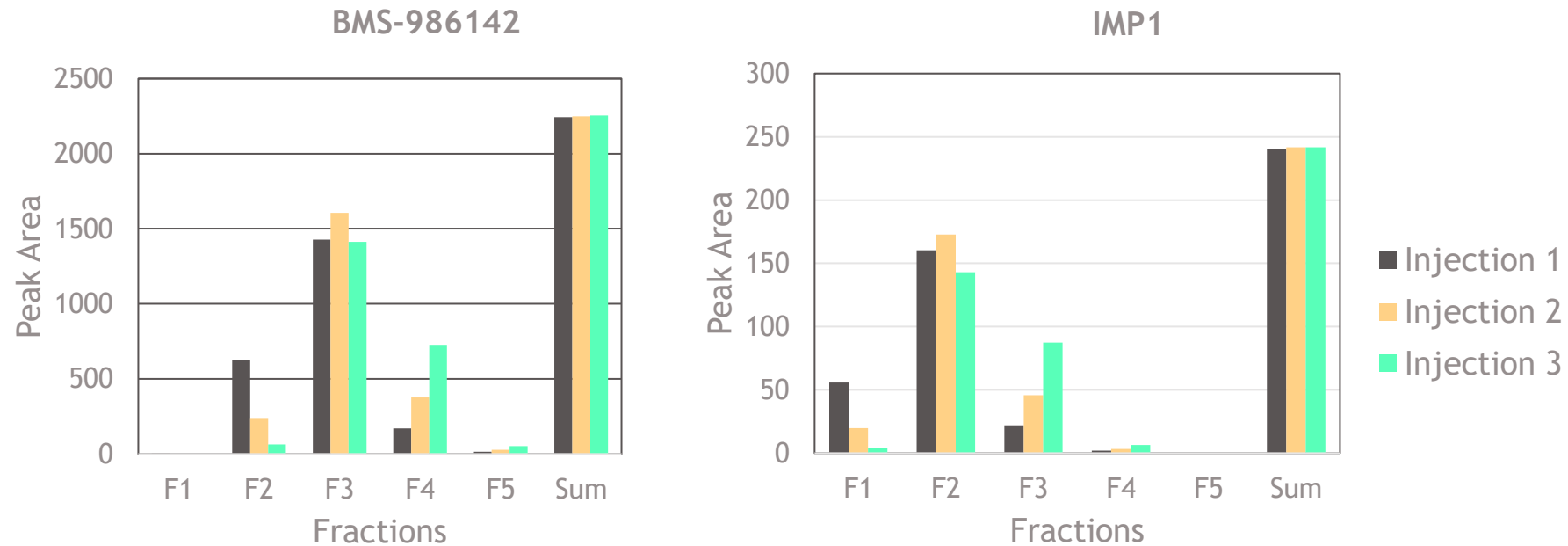

- Large variabilities were observed for individual fractions, however, sum of peak areas were consistent among injections (%RSD=0.3 for both peaks, n=3).
- Average recovery of IMP1 is 101.2% (%RSD=0.2, n=3)

Wang Q, He B, Shackman J, JPBA, 2021, 193:113730

2D-LC with High Resolution Sampling - Sensitivity Evaluation

- Multiple consecutive cuts are required to cover the whole ¹D peak, some levels of sensitivity loss will happen for ²D peaks.



Heart-Cutting with On-line Dilution

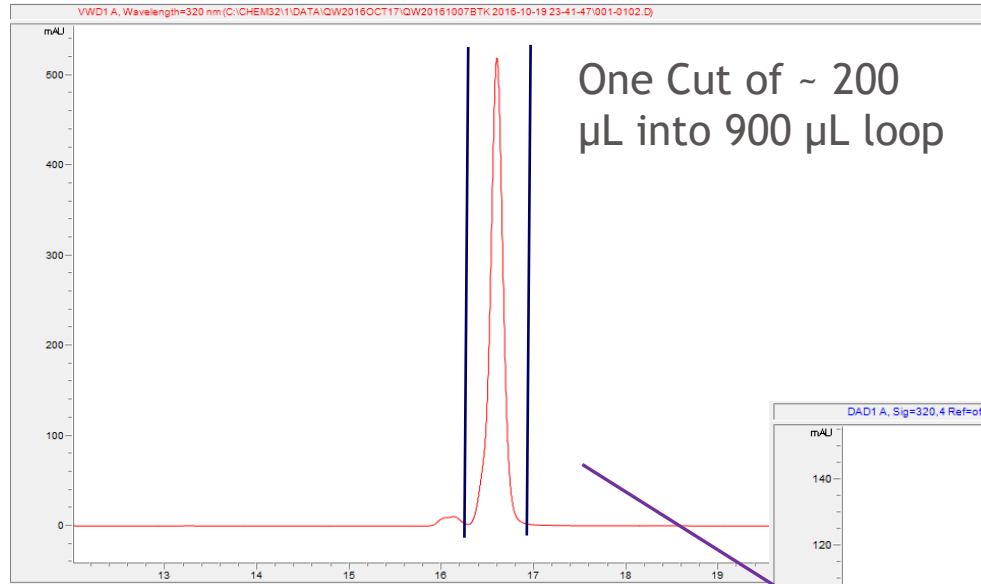

- Peak area %RSD= 0.08% for BMS-986142; and 2.1% for IMP1 (n=4);
- Average recovery of IMP1 is 96.8%.

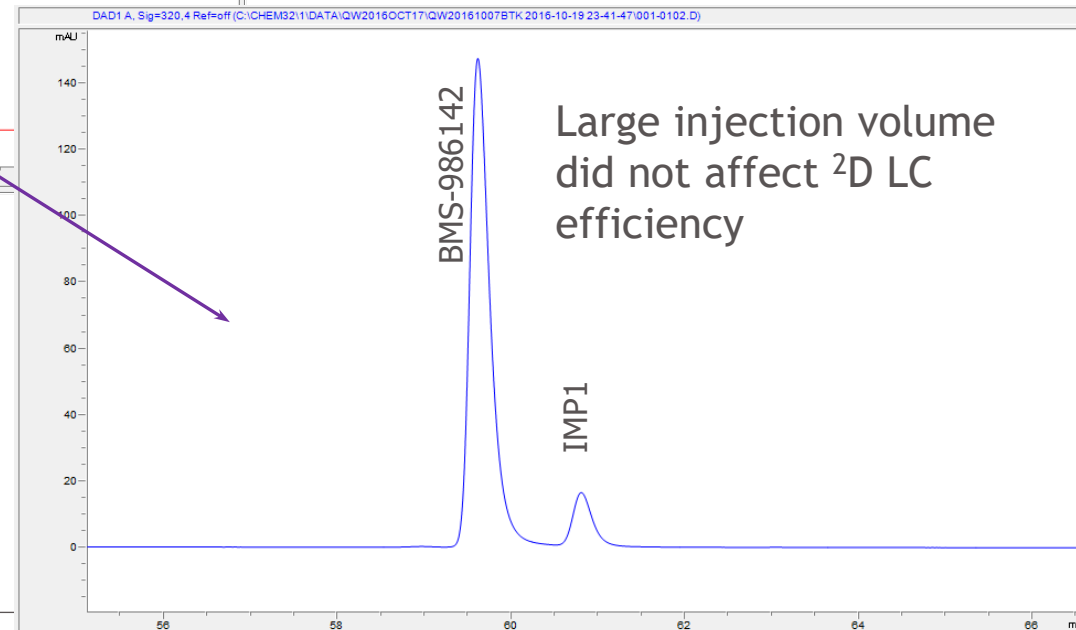

Heart-Cutting with On-line Dilution

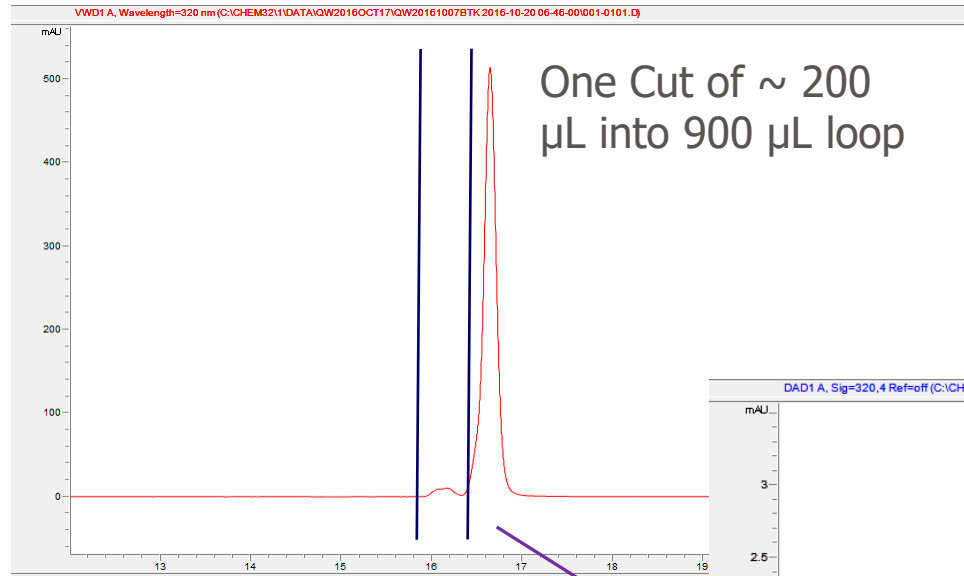

- Peak area %RSD= 0.3% for IMP2; and 3.1% for IMP3 (n=3);
- Average recovery of IMP2 is 98.8%.

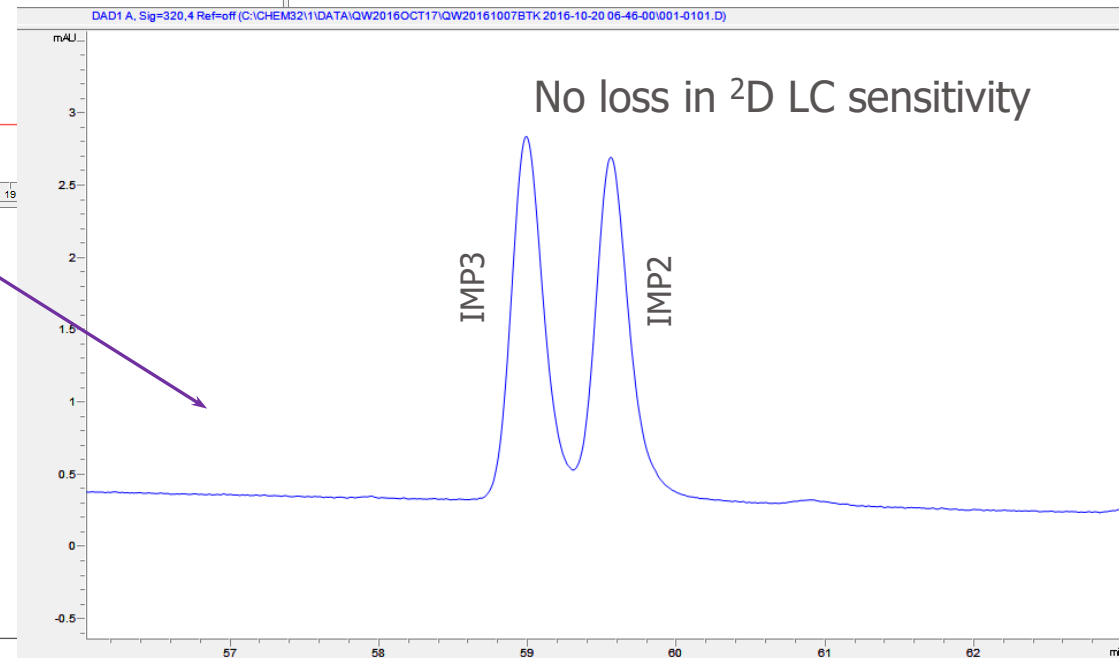

Outline

- Introduction
- 2D-LC applications in BMS for small molecule pharmaceutical analysis
 - 2D-LC peak purity check
 - Quantitative 2D-LC analysis
 - Trapping mode 2D-LC
- Summary

Schematic Diagram of Trapping Mode 2D-LC

- H-Class UPLC components controlled by Empower
- Quantitative low-level impurity enrichment

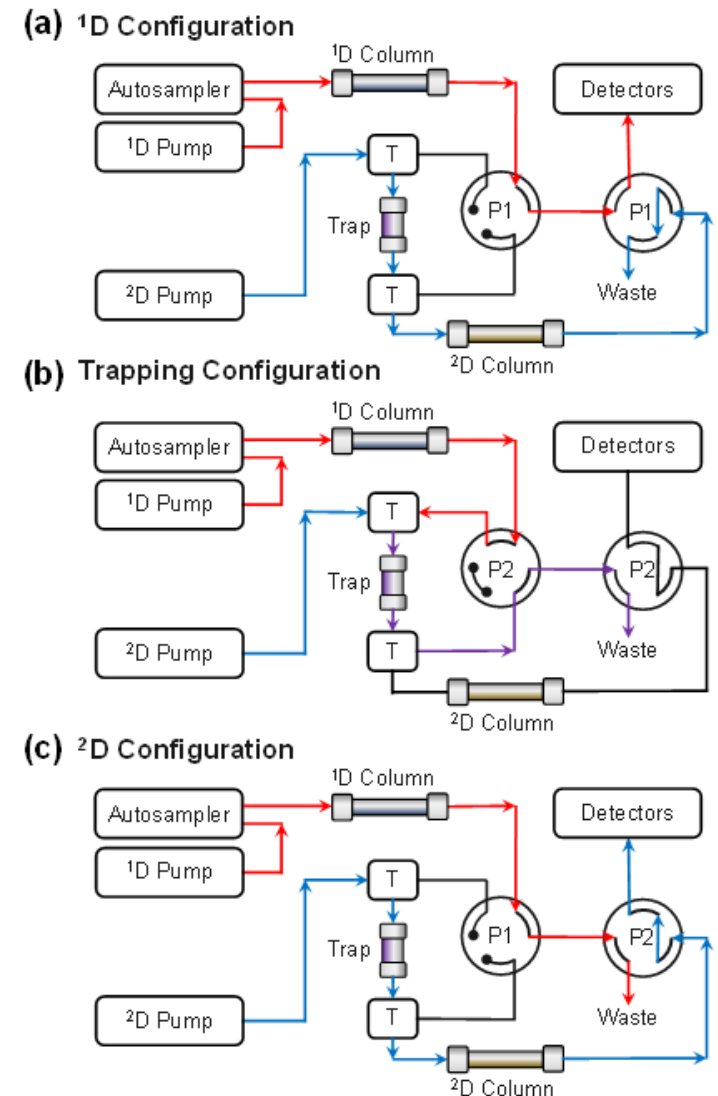

Lin Z, Wang Q, Zhou Y, Shackman J, JCA, 2023, 1700:464043

Performance Verification

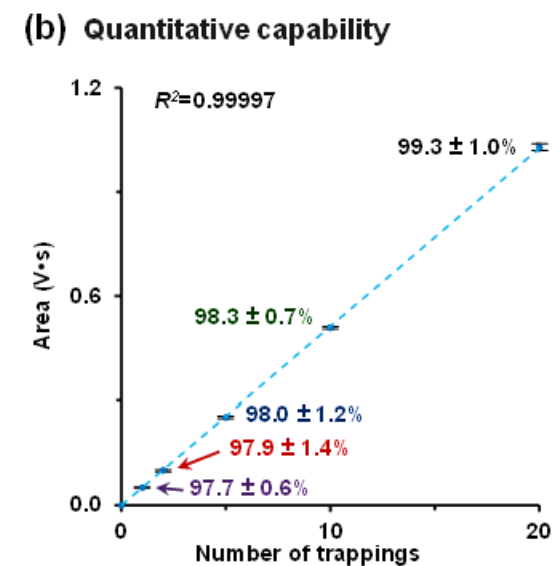
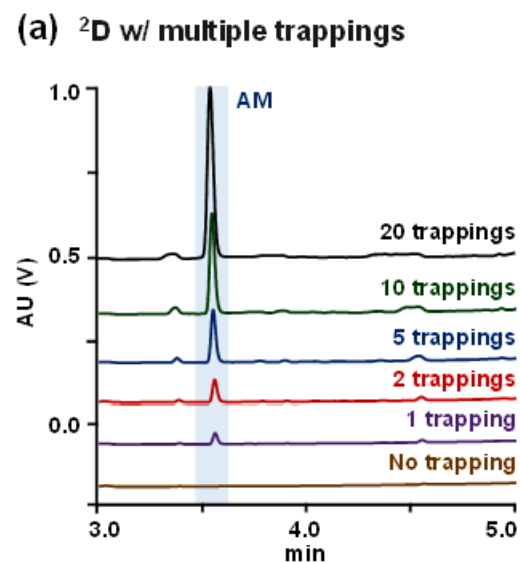
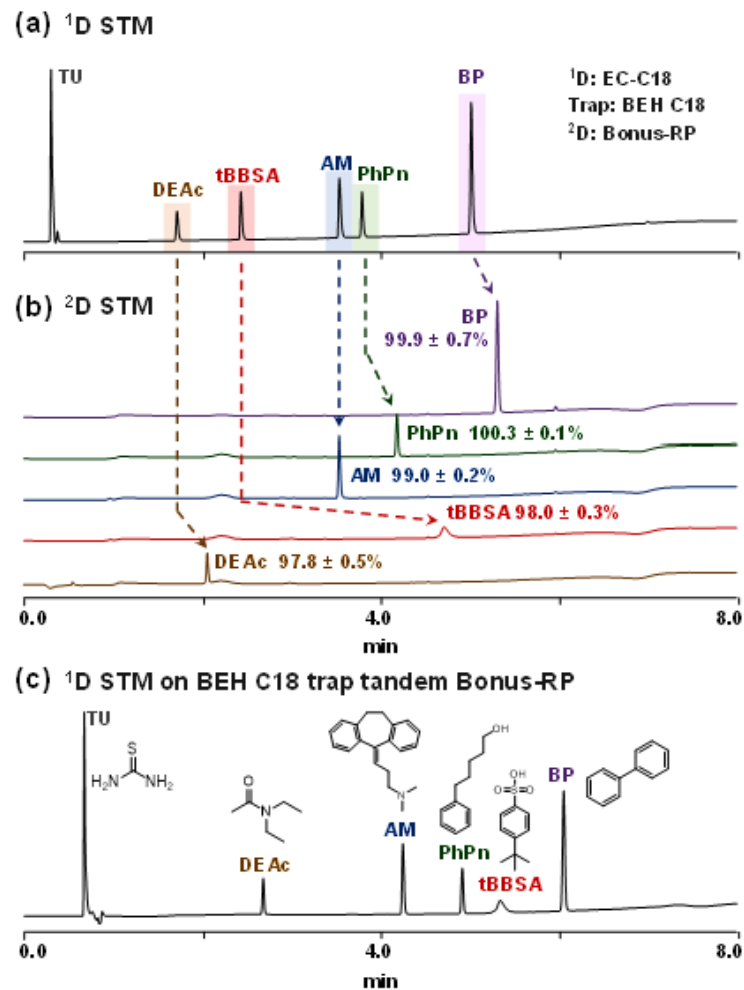

- Trapping can be done for analytes with wide range of hydrophobicity
- Quantitative enrichment over 20 trappings

Lin Z, Wang Q, Zhou Y, Shackman J, JCA, 2023, 1700:464043

Quantitative Trapping of a Mutagenic Impurity

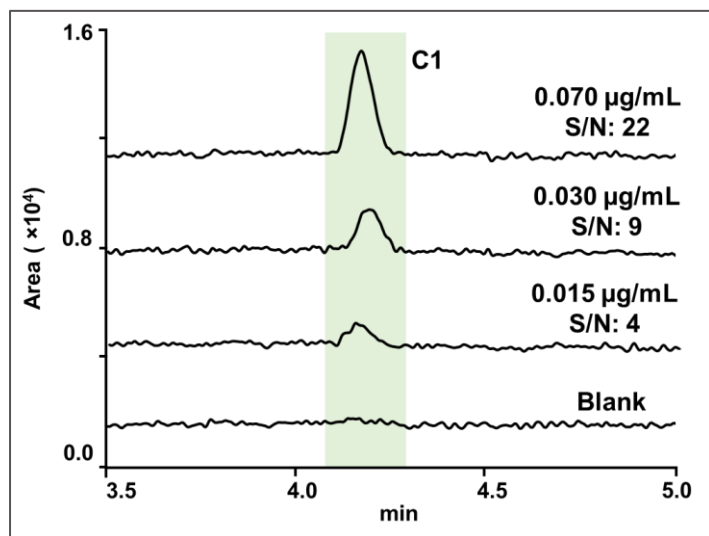

Without trapping

(a) ²D potential MI monitoring

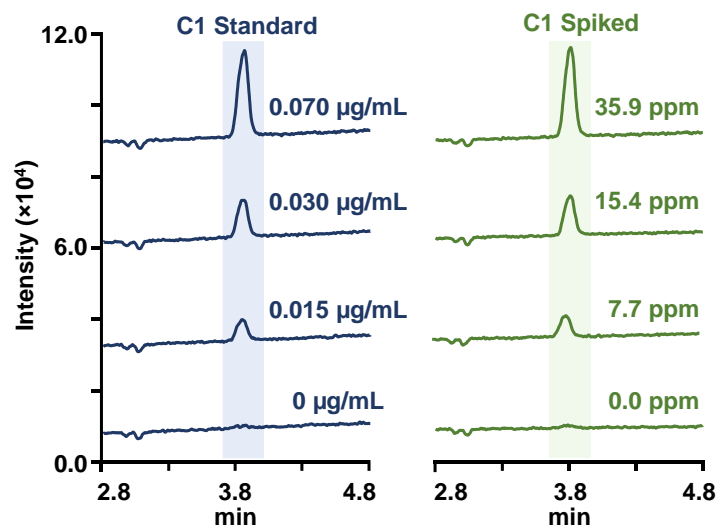

With 4 trappings

(b) ²D quantification

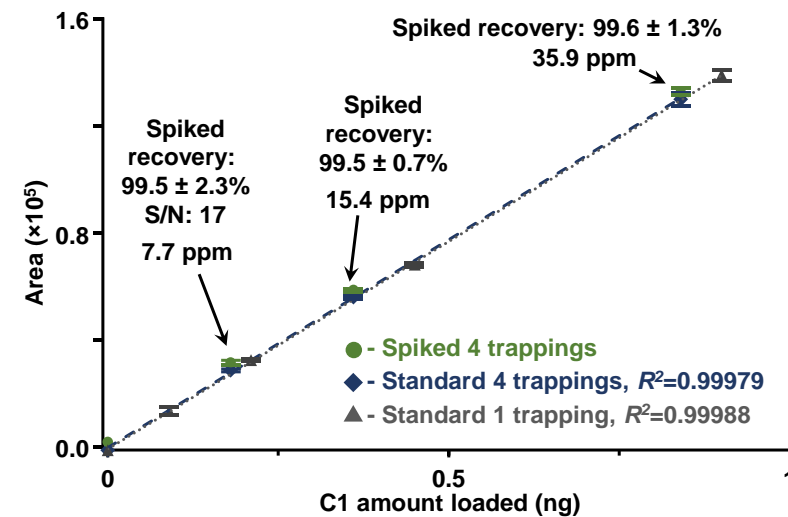

Summary

- An overview of BMS efforts in exploring 2D-LC for fast knowledge generation in chemical process development was presented. The examples include peak purity check by orthogonal RPLC-RPLC-MS, 2D-LC quantitative impurity analysis, and quantitative enrichment of trace level impurities by trapping mode 2D-LC.
- The results demonstrate that 2DLC is a powerful tool in **understanding chemical processes**, as well as **ensuring analytical method quality** for pharmaceutical development.
- For certain types of synthetic drug candidates with complex impurity profiles, 2D-LC has the potential to become the default technique for impurity analysis.

Acknowledgement

- Tom Raglione
- Scott Miller
- Brent Kleintop
- Jason Huang
- Mark Bolgar
- Jessica Conforti (Summer Intern)
- Kaitlyn Frankenfield (Summer Intern)
- Prof. Dwight Stoll