

Solaris XE

User Manual

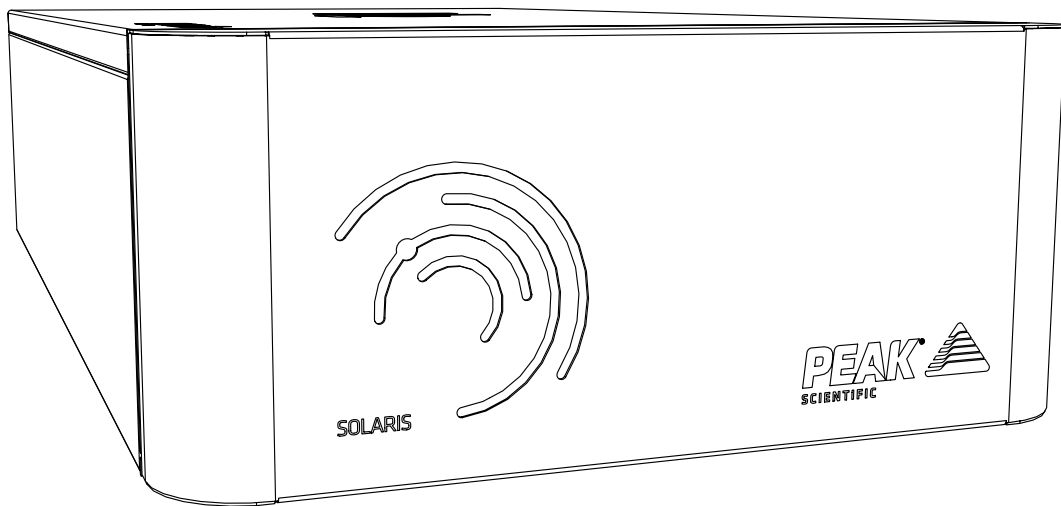

Contents

Change History	3
How to use this Manual	3
Warranties and Liabilities	4
Safety Notices	5
Symbols	5
Safety Notice to Users	5
Declaration of Conformity	6
Environmental Declaration	7
Technical Specification	8
Solaris Nitrogen	8
Unpacking	9
Fittings Kit Contents	10
Unpacking Instructions	10
Installation	11
Generator Environment	11
Generator Overview	12
Solaris XE General Dimensions	12
Solaris XE Rear Connections	13
Electrical Connection	14
Air Purity	15
Class 1 Particulate	15
Class 4 Water	15
Class 1 Oil	15
Connecting to the application	15
Tubing Lengths	15
Start-Up Sequence	16
Setting the Output Pressure	17
Service Requirements	18
Service Schedule	18
Peak Protected	19
Cleaning	20
Troubleshooting	21

Change History

Rev	Comment	Name	Date
1	Initial Release	Liam Couttie	14/03/2018
2	Tech Spec Update	Liam Couttie	02/04/2018
3	Updates to Incorporate CSA Feedback	Liam Couttie	26/07/2018
4	Env. Declaration Updates	Liam Couttie	24/06/2019

How to use this Manual

This manual is intended for end users and has been written as a reference document where you can skip to the relevant information.

Users can refer to the contents page to find the relevant information.

Please review each of the following sections carefully.

Thank you for selecting Peak Scientific to meet your gas generation needs, and should you require any further assistance or support please do not hesitate to contact Peak Scientific or the Peak Partner from which you purchased your generator.

Warranties and Liabilities



1. The Company warrants that it has title to the Goods.
2. Subject to the provisions of this clause the Company warrants that the Goods shall comply in all material respects with any specification referred to in the Order Confirmation (as the same may be amended) and shall, subject thereto, be free from defects in material and workmanship for the lesser of a period of twelve months from the date of delivery or thirteen months from the date of dispatch from the factory.
3. Save as provided in this clause and except where the Goods are sold to a person dealing as a consumer (within the meaning of the Unfair Contract Terms Act 1977) all warranties, conditions or other terms implied by statute or common law are hereby expressly excluded save to the extent they may not be lawfully excluded. When the Goods are sold to a consumer within the meaning of the Unfair Contract Terms Act 1977 their statutory rights are not affected by the provisions of this clause.
4. In the event of the Customer making a claim in respect of any defect in terms of clause 2 hereof the Customer must.
 1. Reasonably satisfy the Company that the Goods have been properly installed, commissioned, stored, serviced and used and without prejudice to the generality of the foregoing that any defect is not the direct or indirect result of lack of repair and/or servicing, incorrect repair and/or servicing, use of wrong materials and/or incorrect spare parts
 2. Allow the company to inspect the Goods and/or any installation and any relevant packaging as and when reasonably required by the Company.
5. Subject to the Company being notified of any defect as is referred to in sub-clause 2 hereof within a reasonable time of it becoming apparent and subject always to the terms of sub-clause 4 hereof, the Company shall, in its option, replace or repair the defective Goods or refund a proportionate part of the Price. The Company shall have no further liability to the Customer (save as mentioned in sub-clause 6 hereof).
6. The Company shall be liable to indemnify the Customer in respect of any claim for death or personal injury to any person in so far as such is attributable to the negligence or breach of duty of the Company or any failure by the Company to comply with the provisions of sub-clause 2 hereof.
7. Save as provided in sub-clause 2 hereof the Company shall not be liable in respect of any claim by the Customer for costs, damages, loss or expenses (whether direct, indirect, consequential or otherwise) or indemnity in any respect howsoever arising including, but not by way of limitation, liability arising in negligence (other than pursuant to clause 6 above) that may be suffered by the Customer or any third party.

Safety Notices

Peak Scientific Instruments cannot anticipate every possible circumstance which may represent a potential hazard. The warnings detailed within this manual refer to the most likely potential hazards, but by definition cannot be all inclusive. If the user employs an operating procedure, item of equipment or a method of working which is not specifically recommended by Peak Scientific, the user must ensure that the equipment will not be damaged or become hazardous to persons or property.

Symbols

This manual uses the following symbols to highlight specific areas important to the safe and proper use of the generator.

 WARNING	A WARNING notice denotes a hazard. It calls attention to an operating procedure, process or similar, which if not correctly performed or adhered to, could cause personal injury or in the worst case death. Do not proceed beyond a WARNING notice until the indicated conditions are fully understood or met.
 CAUTION	A CAUTION notice denotes a hazard. It calls attention to an operating procedure, process or similar, which if not correctly performed or adhered to, could cause damage to the generator or the application. Do not proceed beyond a CAUTION notice until the indicated conditions are fully understood or met.
	Caution, risk of electric shock. Ensure power to the generator has been removed before proceeding.

Safety Notice to Users



These instructions must be read thoroughly and understood before installation and operation of your Peak Generator. Use of the generator in a manner not specified by Peak Scientific MAY impair the SAFETY provided by the equipment.



When handling, operating or carrying out any maintenance, personnel must employ safe engineering practices and observe all relevant local health and safety requirements and regulations. The attention of UK users is drawn to the Health and Safety at Work Act 1974, and the Institute of Electrical Engineers regulations.



If the equipment is used in a manner not specified by the manufacturer, the protection provided by the equipment maybe impaired.

Declaration of Conformity

We Peak Scientific Instruments Ltd.
Of Fountain Crescent, Inchinnan, Renfrewshire, PA4 9RE

Declare that:

Equipment: Nitrogen Generator
Models: Solaris XE

To which this declaration relates, is in conformity with the applicable EC directives, harmonized standards, and other normative requirements.

- Low Voltage Directive 2014/35/EU
EN 61010-1: 2010 Electrical Equipment for measurement, control and laboratory use.
- Electromagnetic Compatibility Directive 2014/30/EU
EN 61326-1: 2013 Electrical Equipment for measurement, control and laboratory use.
- FCC47 CFR Part 15 Class B
Unintentional radiators; Conducted and Radiated emissions limits.

All evaluation, testing and certification issued by:

York EMC Services Ltd.

Earls Road, Grangemouth Technology Park
Grangemouth, Scotland
KY11 9HZ

Nemko Canada Inc.

303 River Road, Ottawa
Ontario, Canada
K1V 1H2

Signed:



Name: Chris Pugh

Date: 11/07/2018

Position: Chief Technology Officer



Environmental Declaration

We Peak Scientific Instruments Ltd.
Of Fountain Crescent, Inchinnan, Renfrewshire, PA4 9RE

Declare that:

Equipment: Nitrogen Generator

Models: Solaris XE

Is fully compliant with the following Directives

- 2012/19/EU WEEE (Waste of Electrical and Electronic Equipment)
- 2011/65/EU & 2015/863 RoHS (Restriction of Hazardous Substance)

Peak Scientific Instruments Ltd fully complies with its obligations towards the European WEEE (Waste of Electrical and Electronic Equipment) Directive 2012/19/EU. These obligations are being met within the B2B compliance group.

Peak Scientific Instruments Ltd, herewith confirm that as a manufacturer of articles we conform to the European Parliament and Council Directives, 2011/65/EU for the original 6 restricted substances listed in the Restriction of Hazardous Substances (RoHS) Directive and Commission Delegated Directive (EU) 2015/863 to include 4 additional restricted substances. Peak Scientific Instruments LTD have developed all reasonable 'due diligence' controls to ensure that our products comply with the principles and requirements of the RoHS (Restriction of Hazardous Substances) Directives.

Where a specific certificate of compliance is required, this can be requested, on a product serial number basis, directly from Peak Scientific Instruments Ltd, by contacting us through our website at www.peakscientific.com

Signed:  Name: Chris Pugh
Date: 21/04/2019 Position: Engineering Director



Technical Specification

Solaris XE

Environment

	Solaris XE
Minimum Operating Ambient Temperature	5°C (41°F)
Maximum Operating Ambient Temperature	35°C (95°F)
Maximum Altitude	2000 m
Maximum Relative Humidity	80% Non-Condensing
Minimum Storage Temperature*	-20°C (-4°F)
Maximum Storage Temperature*	60°C (140°F)

Note: Please ensure that the generator is situated in a well ventilated environment.

Inlet Conditions

Inlet Air Pressure Min-Max	5.51 - 9.99 bar (80 - 145 psi) (125psi min to achieve max output of 35L/min)
Min Air Inlet Flow (For Max Outlet Flow)	up to 100 L/min
Minimum Air Inlet Quality	ISO 8573-1:2010 Class[1.4.1]

Generator Outlets

Maximum Output Pressure	116 psi / 7.99 bar (variable)
Maximum Outlet Flow Rate	up to 35 L/min
Purity	95-99.5% N ₂
Particles	<0.01µm
Phthalates	NONE
Suspended Liquids	NONE
Gas Outlets	1
Start-Up Time For Purity	5 mins

Electrical Requirements

Voltage	100-230v
Frequency	50/60 Hz
Current	0.10A
Input Connection	C14 Plug
Power Cord (Supplied)	C13 Socket to Local Connection
Pollution Degree	2
Insulation Category	II
Fuses (UK Only)	13A BS1362

General

Dimensions cm (inches) WxDxH	34.3 x 65.5 x 15.6 (13.5 x 25.78 x 6.14)
Generator Weight Kg (lbs)	15.1 (33.2)
Shipping Weight Kg (lbs)	18 (39.6)
Max Weight Bearing Kg (lbs)	100 (220)

Unpacking

Although Peak Scientific takes every precaution with safe transit and packaging, it is advisable to fully inspect the unit for any sign of transit damage.

Check 'SHOCKWATCH' label for signs of rough handling prior to unpacking.



Any damage should be reported immediately to the carrier and Peak Scientific or the Peak Partner from where the unit was purchased.

Follow the unpacking instructions posted on the side of the crate. It will require two people to remove the unit from the shipping crate and to manoeuvre the generator onto the bench.

Please save the product packaging for storage or future shipment of the generator.

Note: Included with the generator is a "Fittings Kit" containing mains power leads for UK, EU, JP & US and also all the required fittings and warranty registration card. Be careful not to discard these with the packaging.

Fittings Kit Contents

Supplied in the Fittings Kit are all the fittings required to connect the generator to the application. The contents of the Fittings Kit are as follows:

1. 6mm Teflon Tubing	x 3m
2. ¼” - 6mm Push-Fit Elbow Fitting	x 2
3. UK Mains Power Cable	x 1
4. EU Mains Power Cable	x 1
5. US Mains Power Cable 110v	x 1
6. US Mains Power Cable 230v	x 1
7. JP Mains Power Cable 100v	x 1
8. 2.5mm Hex Key	x 1
9. 3mm Hex Key	x 1
10. No.8 Wall Plug	x 4
11. No.8 Screw	x 4

All of the generators output ports are located on the rear panel of the unit.

Unpacking Instructions

The unit weight constitutes a two person lift and as such, safe lifting practices should be employed; do not attempt to lift on your own, as you will significantly increase the chance of injury & damage to yourself and others around you.

1. Remove the generator from the packaging.
2. Next, with someone on either side of the unit, position your hands underneath the unit ready to lift.
3. Ensuring your knees are bent and your back is straight, lift the unit to the desired location.

Installation

Generator Environment

The generator should be situated in a well ventilated environment and positioned such that it can be easily disconnected if required. The generator is designed for indoor use only. It should be installed adjacent to, underneath or in between the application(s) it is supplying (maximum weight bearing up to 100kg) or it can be mounted onto a wall horizontally; refer to installation guide for mounting details. If this is not convenient then the unit can be sited elsewhere, however, consideration should be made of the lengths of pipe runs as pressure drops can result from extended runs of pipe.

The performance of the generator (like all sophisticated equipment) is affected by ambient conditions. Note should also be taken to the proximity of Air Conditioning outlets. These can sometimes give rise to “pockets” of air with high relative humidity. Operation of the unit within such a pocket could adversely affect its performance. Consideration should also be given to the air flow around the unit. It is recommended that an air gap of 75mm (3”) should be maintained down both sides and at the rear of the unit. Please refer to the drawing on the next page for the general dimensions of the unit.

Minimum Operating Ambient Temperature: 5 °C (41 °F)

Maximum Operating Ambient Temperature: 35 °C (95 °F)

Generator Overview

Solaris XE General Dimensions

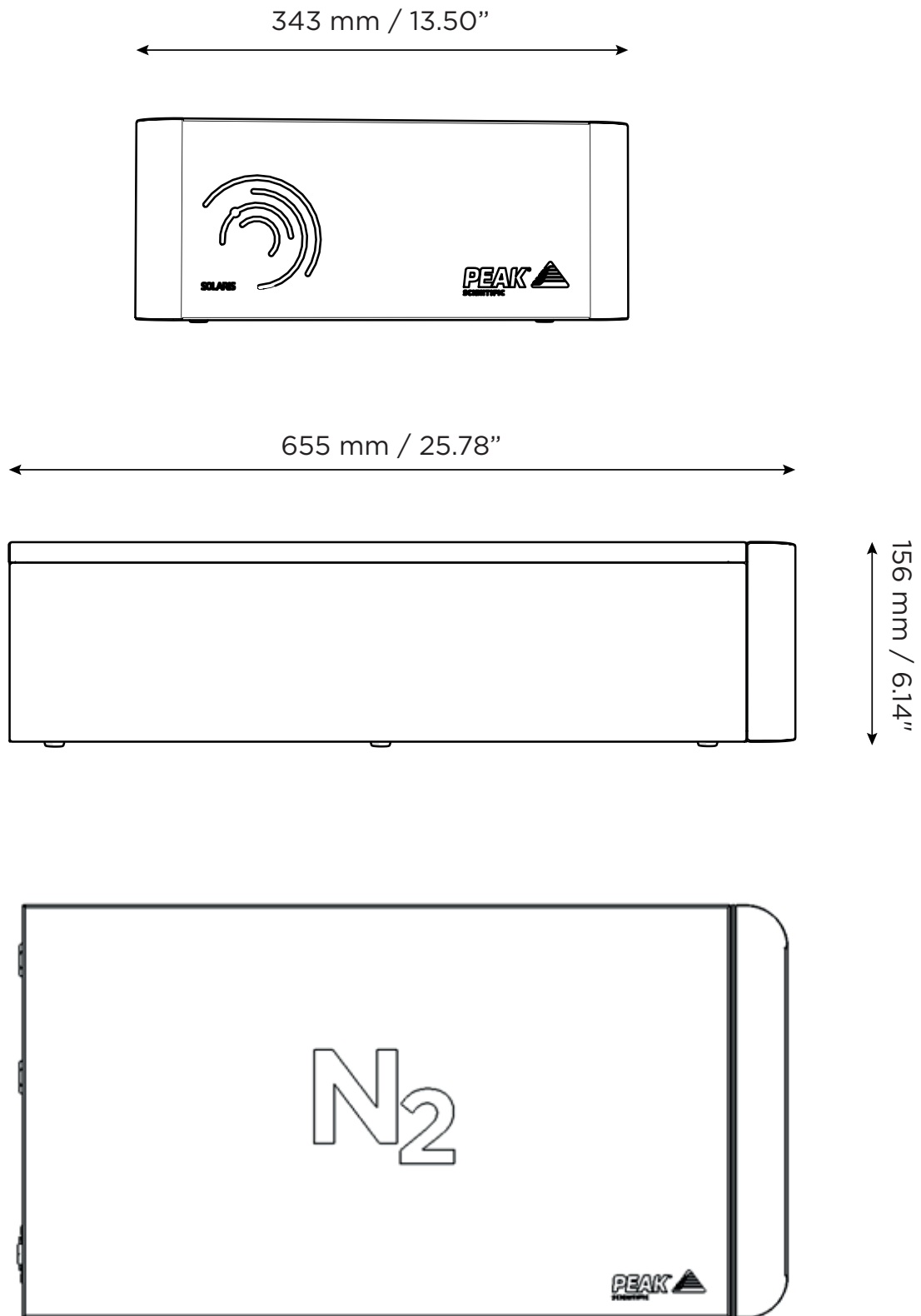

Horizontal postioning on wall.

Solaris XE Rear Connections

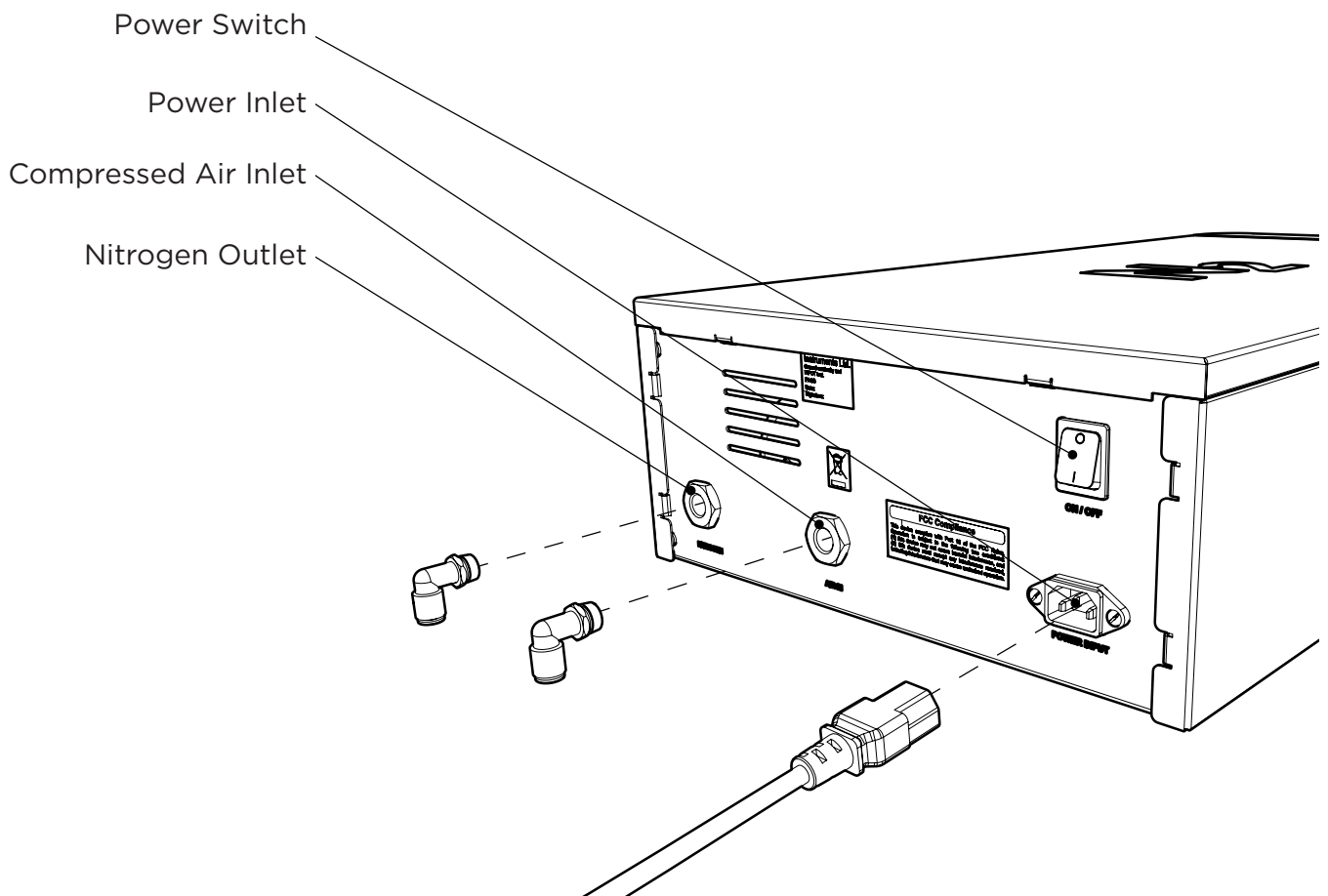

Ensure outlets are connected to correct application. Connections should only be carried out by trained personnel.



The Generator should be switched off prior to maintenance and cleaning.

Electrical Connection

Connect the generator to an appropriate 100-230 volt single-phase supply, refer to the generator serial plate for input specification and ensure your supply matches the requirements.

If the appropriate power cord is not supplied; a new plug, rated to at least 12 amps, can be fitted by a qualified electrician. If a substitute mains supply cord is used, ensure that it has an adequate rating. Failure to do so could cause damage to the generator.



This unit is classified as SAFETY CLASS 1. THIS UNIT MUST BE EARTHED. Before connecting the unit to the mains supply, please check that your electrical supply falls within the specified range, see below.

EARTH/GROUND (E):-	Green & Yellow	or	Green
LIVE (L):-	Brown	or	Black
Neutral (N):-	Blue	or	White

Electrical requirements are 100-230VAC nominal +/- 10% depending on chosen model. However, running continuously at voltages outside this is not recommended. Extended periods at extremes can have a detrimental effect on the operation and life of the generator.



If the equipment is used in a manner not specified by the manufacturer, the protection provided by the equipment maybe impaired.

Unit is fully pneumatic and can function without electricity.

If the unit is not connected to a power supply the pressure status indicator feature will not be available and the LED lights will not function. The unit will perform all other functions.

Air Purity

The Solaris XE generator should be connected to an air supply that, as a minimum, meets ISO8753-1:2010 Class 1.4.1

Class 1 Particulate

In each cubic metre of compressed air, the particulate count should not exceed 20,000 particles in the 0.1 - 0.5 micron size range, 400 particles in the 0.5 - 1 micron range and 10 particles in the 1 - 5 micron size range.

Class 4 Water

A pressure dew point (PDP) of +3°C or better is required and no liquid water is allowed.

Class 1 Oil

In each cubic metre of compressed air, not more than 0.01mg of oil is allowed. This is a total level for liquid oil, oil aerosol and oil vapour.

Connecting to the application

Select the ¼"- 6mm push fitting from the fittings kit and connect to the generator AIR IN and NITROGEN ports on the rear panel. Using suitable 6mm tubing, connect the outlet of the generator to the inlet on the application.

Please refer to the Tubing Lengths section, to ensure correct tubing is being used.



Once the tubing is connected to the application, please ensure that it is thoroughly checked for being leak-tight. Even the slightest leak in the gas supply between the generator and the application can lead to a reduction in efficiency.

Tubing Lengths



The diameter of the tubing which will be connected to the gas outlet is important and is determined by the length of tubing required. Failure to follow these recommendations could lead to pressure between generator and application.

- < 10 meters: Use ¼"/₁₆" (¼" O/D, ₃/₁₆" I/D) P.T.F.E. tubing.
- > 10 - 40 meters: Use ₃/₈"/₁₆" (₃/₈" O/D, ₅/₁₆" I/D). Tubing and fittings not supplied in the fittings kit.
- > 40 metres: Please contact Peak Scientific with the relevant distance and we will calculate the flow resistance and the tubing size required.

A combination of ¼"/₁₆" and ₃/₈"/₁₆" tubing may be used to ensure that there is no large diameter tubing within the lab (i.e. for the first 20 meters from the generator use ₃/₈"/₁₆" and the final 10 meters to the application use ¼"/₁₆" tubing). Keep the connections and bends to a minimum.

Start-Up Sequence

Connect the generator to the application as described in the installation guide. Switch the generator on using the power switch on the rear panel of the unit and connect to the air supply. Please note: Air can flow through the generator without the power switched on, however the power must be switched on to give an indication of internal pressure in the system.

The LED's on the front panel will illuminate **YELLOW**.

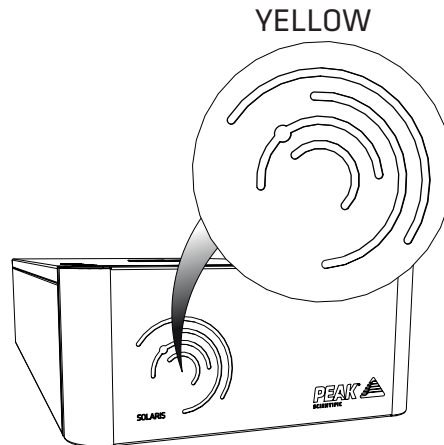

Turn the air supply on. The fascia will illuminate **GREEN** when adequate system pressure has reached 80psi. The Generator will provide Nitrogen almost instantaneously.

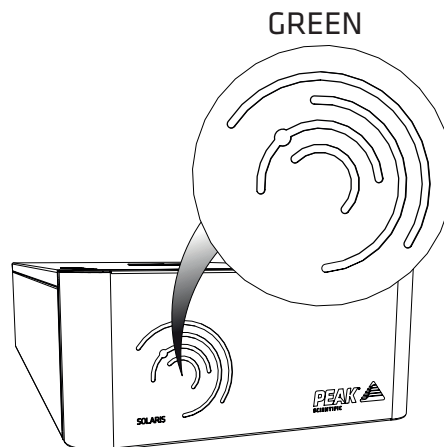

The Generator will illuminate **YELLOW** if adequate internal pressure is not met or is lost during operation. If the unit displays **YELLOW** during operation, disconnect the unit from your appliance and check the input air supply to the generator.

Setting the Output Pressure

The generator will deliver Nitrogen at the rated flow up to a maximum pressure of 116psi, assuming an adequate air supply. The output pressure can be adjusted using the regulator at the front of the generator and viewed on the adjacent gauge.

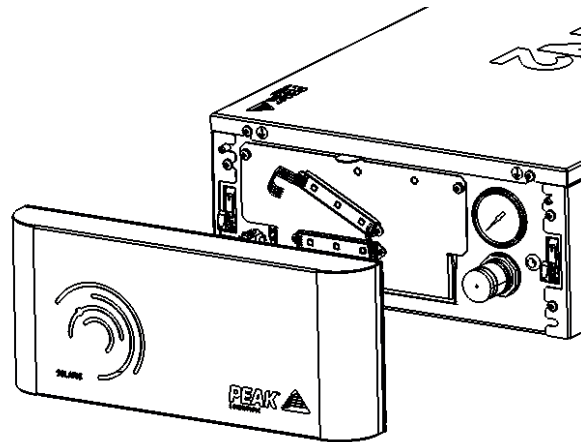

To access the regulator, unclip the fascia from the unit.

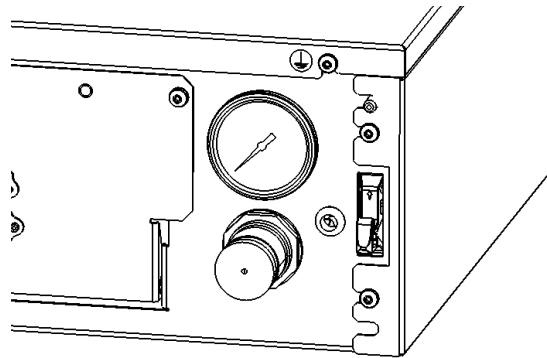

Adjust the gauge to the required pressure. To ensure a smooth pressure profile, it is not recommended to increase the output pressure to above the factory set 116psi.



If earth cable is removed from front fascia, ENSURE it is attached before using the generator .

Service Requirements

Service Schedule

Purchase Interval	Component	Visit	Qty.
12 months	Solaris Nitrogen XE Annual Maintenance Kit	www.peakscientific.com/ordering	1

Please note: Only Peak Scientific approved components should be used.

Peak Protected

With Peak Scientific you invest in not only a product but peace of mind. With a network of certified Peak engineers stationed throughout the globe, Peak's rapid response team are never far away and our commitment is to keep your generator running day in, day out, protecting your laboratory workflow.

[Peak Protected] can provide...



Installation
A dedicated Peak engineer will visit your lab to install and setup your generator



Complete plan
Swift response by a Peak Service Engineer within 72 hours & planned preventative maintenance



Premium Protected
Guaranteed rapid on-site response within 24 hours & planned preventative maintenance



IQ/OQ
Certified assurance for applications requiring documented qualification

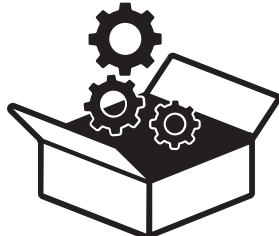

Spares
Genuine Peak parts with express delivery, ensuring optimal performance and lifetime



Technical Support Hotline
Around the clock support by phone or online with our global technical helpdesk

To find out more about protecting your investment visit: www.peakscientific.com/protected

Cleaning

Clean the outside of the generator only using warm soapy water and a clean damp cloth. Ensure all excess fluid is thoroughly removed from the cloth prior to use.



Cleaning should only be undertaken with the power switched off and the power cord removed from the rear of the generator.





Under no circumstances should any solvents or abrasive cleaning solutions be used as these can contain fumes that could be harmful to the generator.



Care should be taken with Leak Detections Liquids.

Troubleshooting

Problem	Possible Solution
<p>The generator will not switch on and the power switch does not illuminate.</p>	<ul style="list-style-type: none"> • Ensure power cord is plugged into the generator and that the power socket is turned on. • Check the fuse in the power cord plug. • Contact your service provider. 
<p>The fascia LED's have not illuminated but the power switch is illuminated.</p>	<ul style="list-style-type: none"> • Contact your service provider. 
<p>The fascia Yellow illumination does not change to green.</p>	<ul style="list-style-type: none"> • Check the air supply pressure to the generator. • Contact your service provider.
<p>The instrument is reporting low pressure. The fascia has turned from Green to Yellow</p>	<ul style="list-style-type: none"> • Check for leaks between the generator and instrument. • Contact your service provider.

Go Online or Complete and Return

We know that registering any of your recently purchased products is not the first thing on your mind- but it is very important to both of us. Not all warranties are alike and Peak Scientific stand out against other gas suppliers as we offer a comprehensive, quick response, on-site warranty. This means that in the very unlikely case that your gas generator develops a fault we have rapid support teams on-hand around the world who are able to come to your lab and get you back up and running in no time.

Register for your **comprehensive 12 month on-site warranty** with ease online at www.peakscientific.com/protected.

Alternatively, you can send the completed form to Peak Scientific by post or email at warranty@peakscientific.com.

Go Online or Complete and Return

You can register for your **FREE 12 month Warranty** with ease online at www.peakscientific.com/protected.

Alternatively, you can send the completed form to Peak Scientific by post or email at warranty@peakscientific.com.

Product Warranty Registration			
Contact name			
Email address			
Company			
Address			
City/Town			
Postcode			
Country			
Telephone			
Generator serial #			
Model type			
Installation date			
Do you still use an alternative gas solution i.e. cylinders or bulk liquid?	Yes	No	
What gas requirements do you have in your lab?	Hydrogen	Nitrogen	Zero Air

Extend your cover with

Peak Scientific offer comprehensive gas generator after sales support packages. Peak [Protected] aftercare support can guarantee an on-site response within 72 hours*, genuine parts from our ISO9001 approved factory and a 95% first-time fix rate. See our enclosed Peak [Protected] leaflet for further information.

Important!

You have 1 month to register your Peak Scientific product from the date of installation. Once registered the warranty will be honoured for a period of 12 months. If you wish to defer the installation of your generator, you must notify Peak Scientific immediately by emailing warranty@peakscientific.com. For generators that remain unregistered after 1 month from the shipment date, the warranty will be considered active from the date of factory dispatch.

* Complete Plan only



Important!

You have **1 month to register** your Peak Scientific product from the date of installation. Once registered the warranty will be honoured for a period of 12 months. If you wish to defer the installation of your generator, you must notify Peak Scientific immediately by emailing warranty@peakscientific.com. For generators that remain unregistered after 1 month from the shipment date, the warranty will be considered active from the date of factory dispatch.

[**PEAK Protected**]TM

Peak Scientific has highly trained, fully certified Field Service Engineers located in over 20 countries across every continent around the world. This allows us to provide an industry-leading rapid response service to our customers. With [**Peak Protected**], your laboratory's productivity becomes our top priority.

To discuss Peak Protected generator cover and payment options speak to your local Peak Representative or for further information contact: protected@peakscientific.com

Peak Scientific

Fountain Crescent
Inchinnan Business Park
Inchinnan
PA4 9RE
Scotland, UK

Tel: +44 141 812 8100

Fax: +44 141 812 8200

For further information on any of our generator products please contact marketing@peakscientific.com

