

Theory and Key Principles Series

Gas Chromatography (GC)

Session 6 – Choice of Detectors for GC

Introduction

Welcome to Shimadzu's Gas Chromatography Theory and Key Principles Series!

Presenter



Ollie Stacey

GC/GCMS
Technical
Specialist

- Part of Shimadzu team for >2.5 years
- Previous experience with TOF-GCMS
- Expertise in GCxGC and GCxGC-MS

Theory & Key Principles Series – GC

- *Introduction to Gas Chromatography* *
- *GC Columns* *
- *The Split/Splitless Inlet* *
- *Advanced Liquid Injection Techniques* *
- *Alternatives to Liquid Injection* *
- **Choice of Detectors for GC**
- Processing GC Data
- Maintenance & Troubleshooting
- Method Development

* Now available on demand at www.shimadzu.co.uk/webinars

Choice of Detectors for GC

In this presentation:

- Factors to consider

- Key principles of operation
- Sensitivity & selectivity
- Requirements
- Considerations

Flame Ionisation Detector	(FID)
Thermal Conductivity Detector	(TCD)
Electron Capture Detector	(ECD)
Barrier Discharge Ionisation Detector	(BID)
Sulfur Chemiluminescence Detector	(SCD)
Flame Photometric Detector	(FPD)
Flame Thermionic Detector	(FTD)

Factors to consider



Sensitivity

The most obvious consideration is sensitivity!

Different detectors offer different sensitivity limits.

How is sensitivity defined?

Most detectors have a Minimal Detectable Quantity (MDQ).

Sensitivity is also method-related – Method Detection Limit (MDL).

Most commonly used for day-to-day analytical work are Limit Of Detection (LOD) and Limit Of Quantitation (LOQ).

These are usually related to a **signal-to-noise ratio** (S/N or SNR).

Typically: LOD = 3:1 LOQ = 10:1

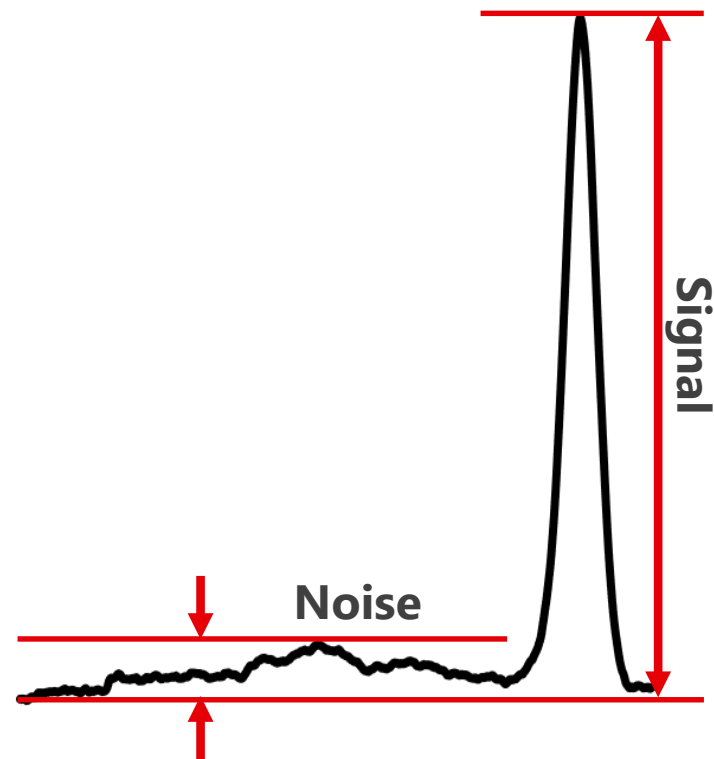

Dynamic range

Dynamic range

Range over which a change in analyte concentration causes a change in detector response.

Lowest point = minimum detectable quantity

Highest point = detector saturation

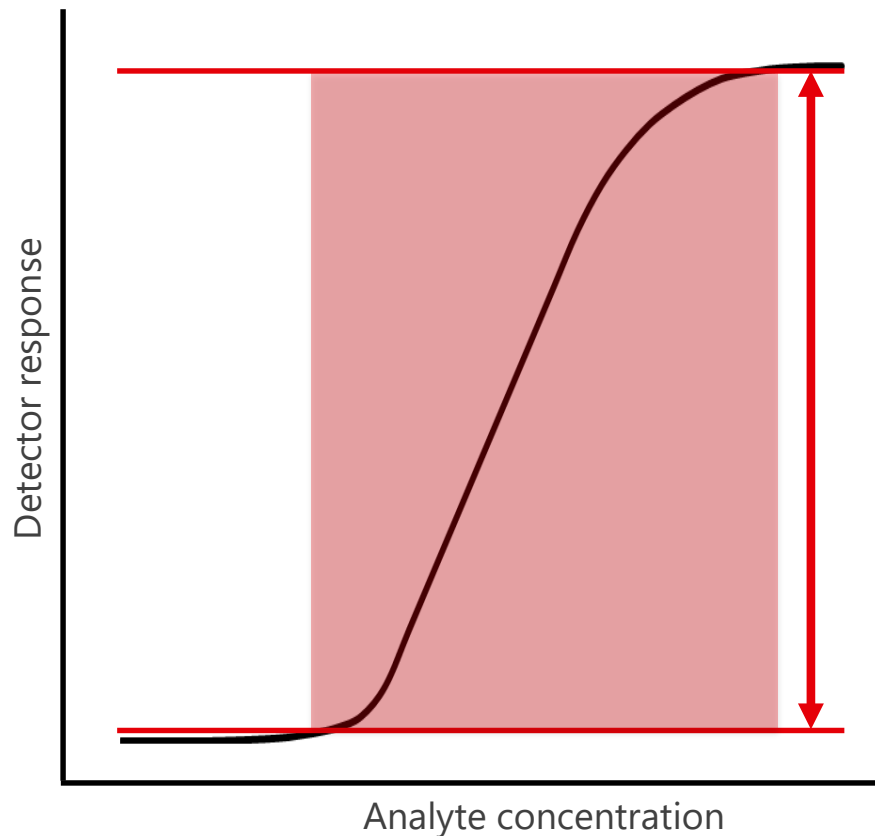

Dynamic range

Dynamic range

Range over which a change in analyte concentration causes a change in detector response.

Lowest point = minimum detectable quantity

Highest point = detector saturation

Linear dynamic range (LDR)

Range over which a linear change in analyte concentration causes a linear change in detector response.

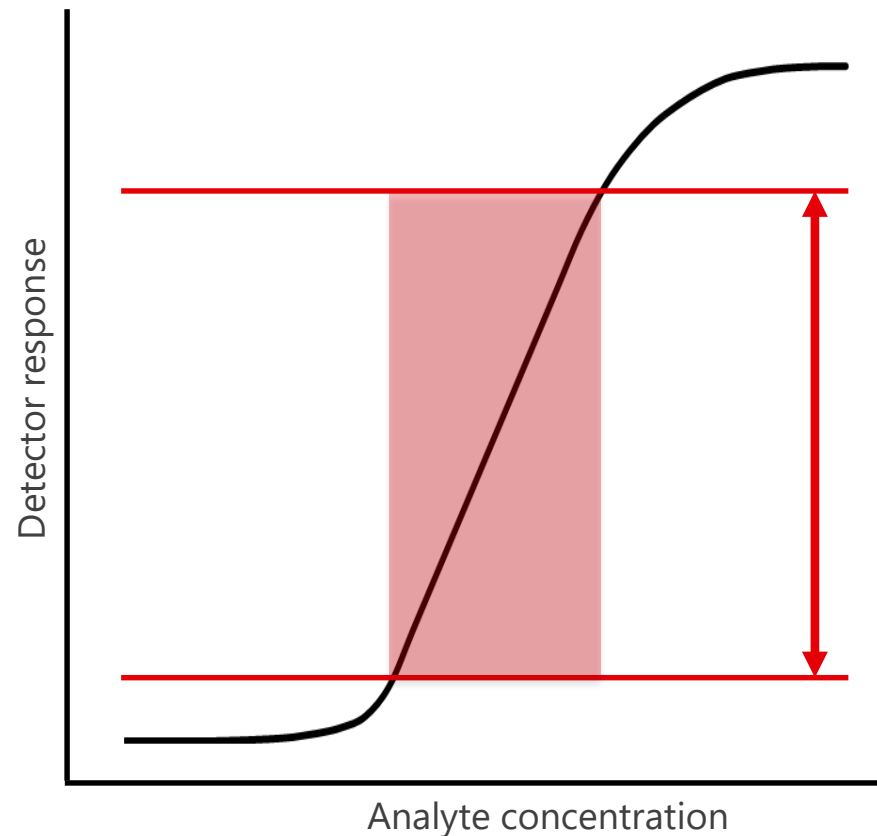

Universal vs. selective

Not all detectors can detect everything!

<u>Universal</u>	<u>Selective</u>
Detects everything, or almost everything	Detects specific elements or chemical properties
General purpose – can be used for a wide range of different applications	Specialised – might only be useful for a single application
Matrix effects might hide compounds of interest	Matrix can become invisible to the detector
e.g. Impurity testing	e.g. Sulfur content in fuel & feedstocks
Tend to be very robust	Less robust

Other properties

Destructive vs. non-destructive

Non-destructive detectors can be coupled to a second detector!

Concentration detector vs. mass detector

Concentration detectors measure the concentration of analytes in the gas flow.

Signal is affected by column flow and make-up gases.

Mass detectors measure the total mass, or mass flow.

Signal is independent of make-up flows.

Flame Ionisation Detector (FID)

Flame Ionisation Detector (FID)

Most common detector in gas chromatography!

Can be used for almost all compounds with C-H or C-N bonds.

Used mostly for the analysis of organic compounds in a wide range of applications.

Specificity	Universal (mostly)
Sensitivity	0.1 ppm [0.1 ng]
Dynamic range	10^7
Detector type	Mass detector
Properties	Destructive

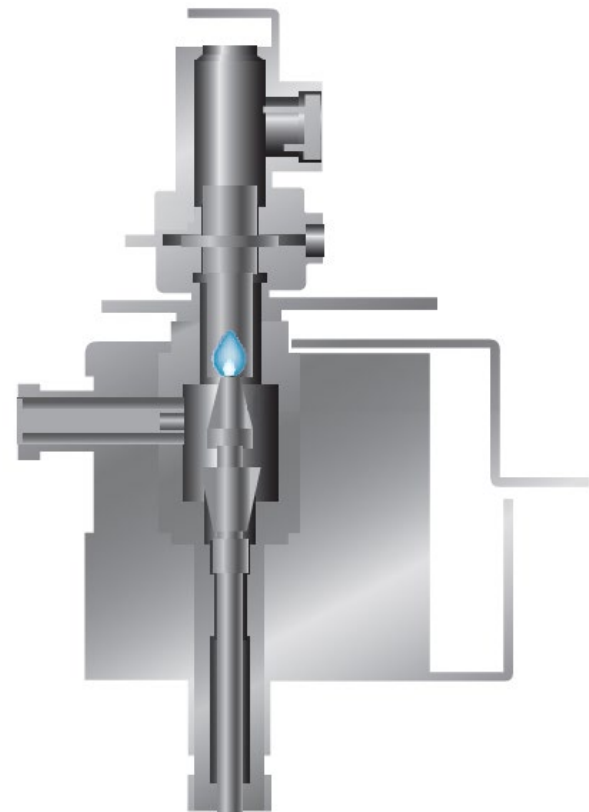

Fundamentals

FID uses an air-hydrogen flame to burn analytes.

Oxidative process results in electrons being formed, which are picked up on the collector.

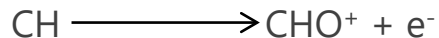

This generates a positive electrical signal response.

Most FIDs use a make-up gas to optimise sensitivity.

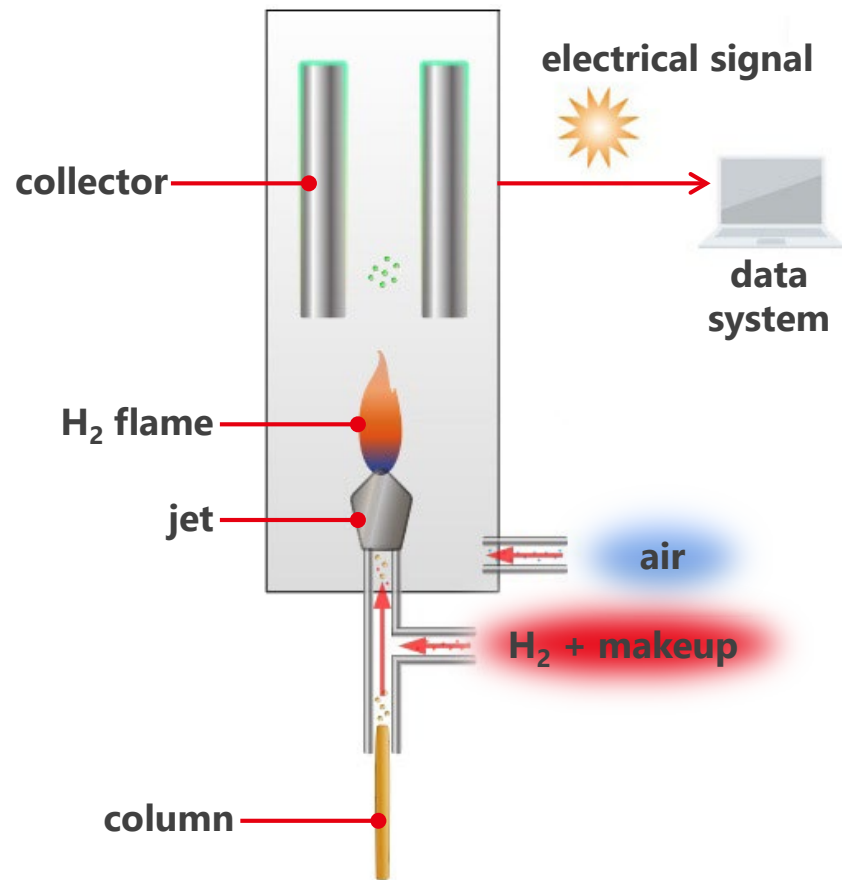

Application

Analysis of water, sediment and soil for hydrocarbon contamination.

Results are usually expressed as a total amount.

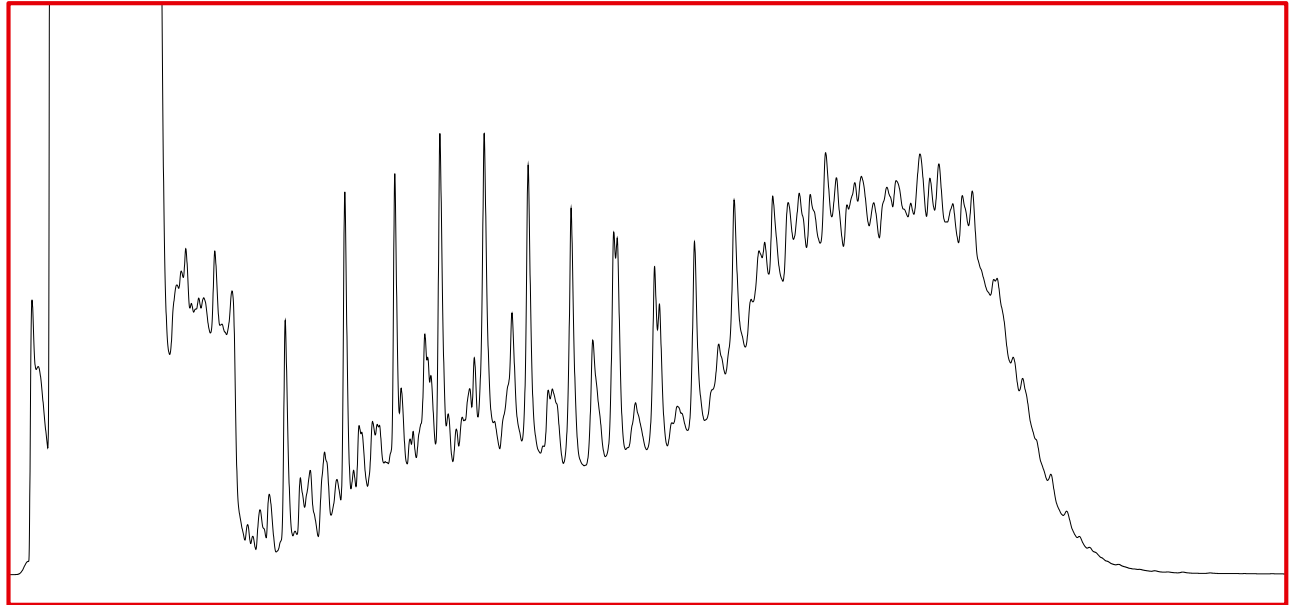

Considerations

Requires hydrogen.

Carbonyl groups (C=O) are not detectable.

Does not respond to He, Ar, N₂, O₂, CO, CO₂, H₂O, etc.

Can be used with a methaniser for CO & CO₂.

Response is proportional to number of C-H or C-N bonds.

10 ppm of C₁₀H₂₂ will have a higher response than 10 ppm of C₂H₆

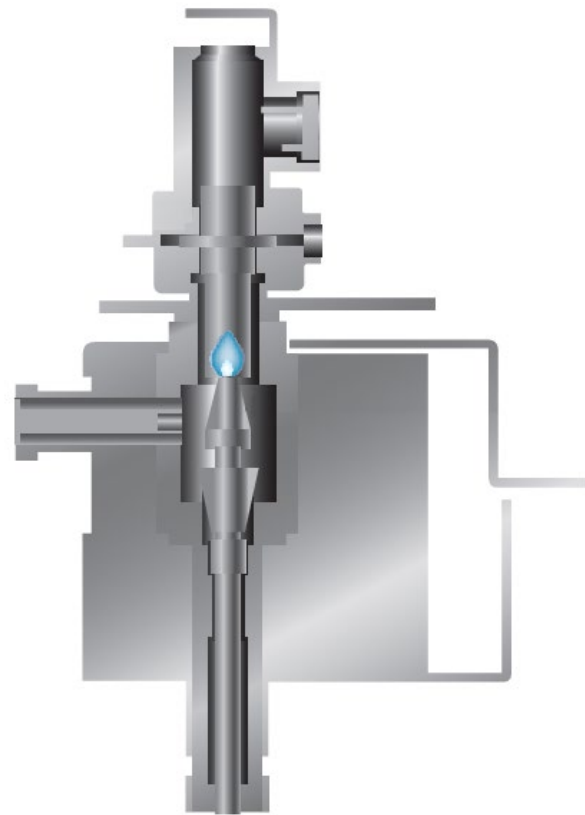

Thermal Conductivity Detector (TCD)



Thermal Conductivity Detector (TCD)

Very common detector in gas chromatography!

Completely universal detector.

Used for gas analysis and where sensitivity is not a priority.

Specificity	Universal
Sensitivity	10 ppm [10 ng]
Dynamic range	10^7
Detector type	Concentration detector
Properties	Non-destructive

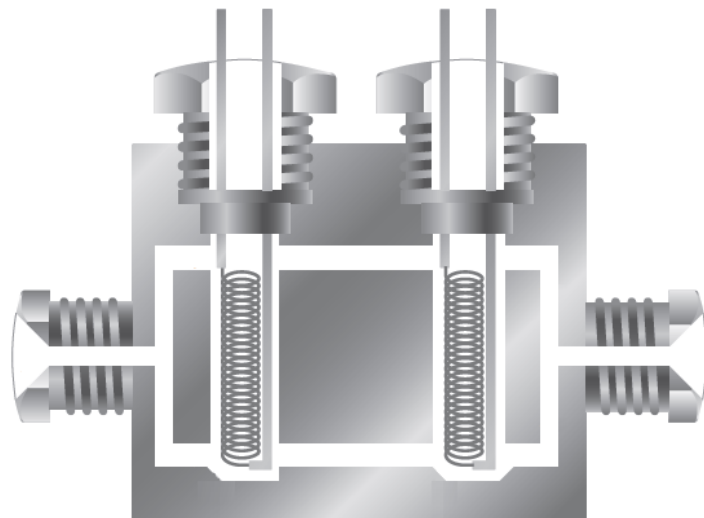

Fundamentals

Different compounds have different thermal conductivity constants.

Compound	Thermal conductivity constant (10^{-6} cal/s·cm·°C)
<i>Helium</i>	408
<i>Hydrogen</i>	547
<i>Nitrogen</i>	73
<i>Argon</i>	52
Oxygen	76
Water	60
Ethane	77
Methane	98
Carbon monoxide	69
Carbon dioxide	49

Fundamentals

Voltage or direct current applied between A & B.

Filaments are held at a constant temperature.

As analyte passes through cell, filament temp increases/decreases.

Detects difference in thermal conductivity between analyte and carrier gas.

Signal registers on data system.

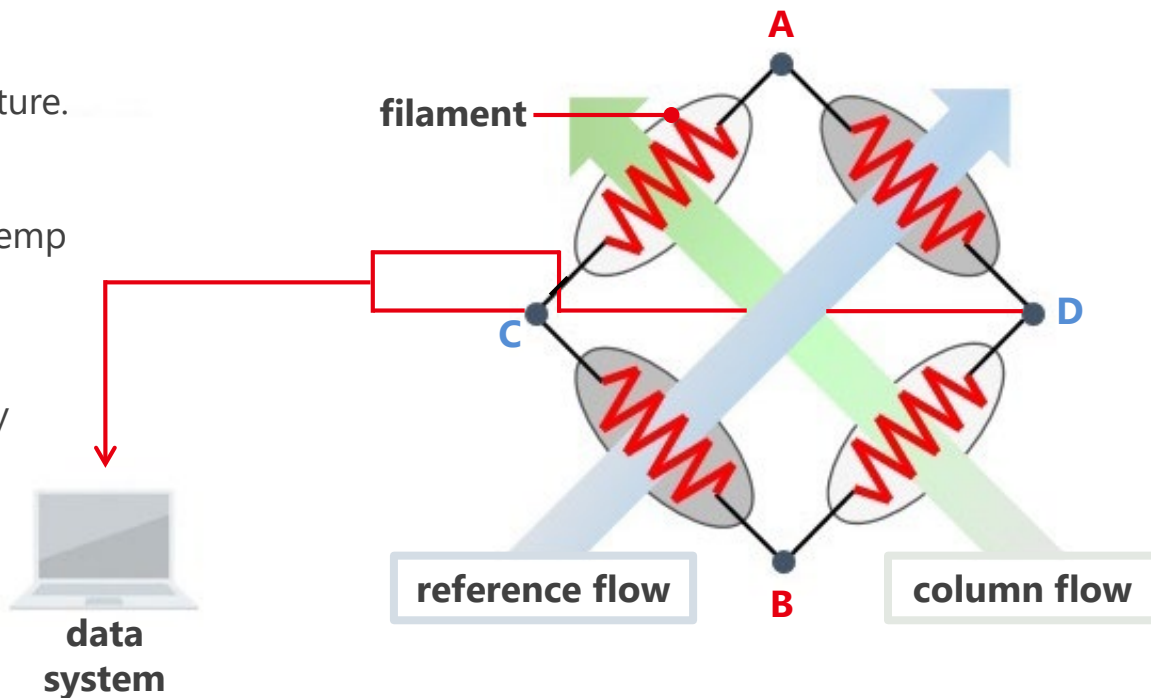

Fundamentals

When the Thermal Conductivity of the Analytical Target Component is Lower than the Carrier Gas

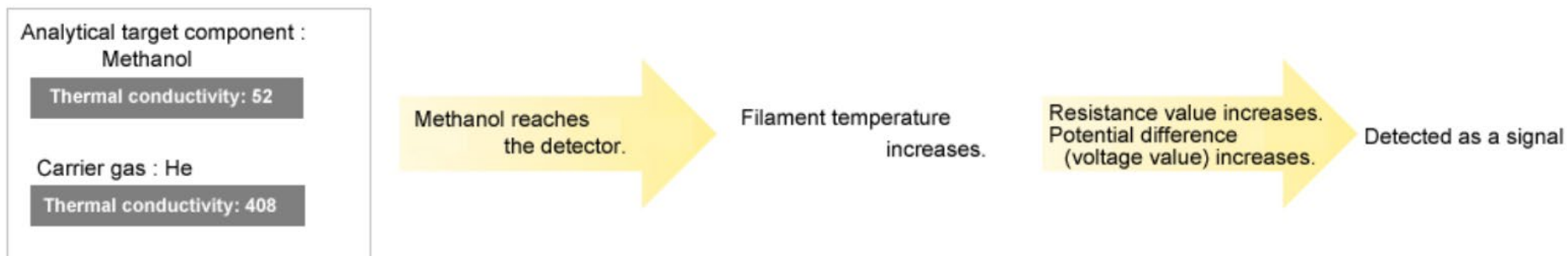

Selection by Analytical Objective

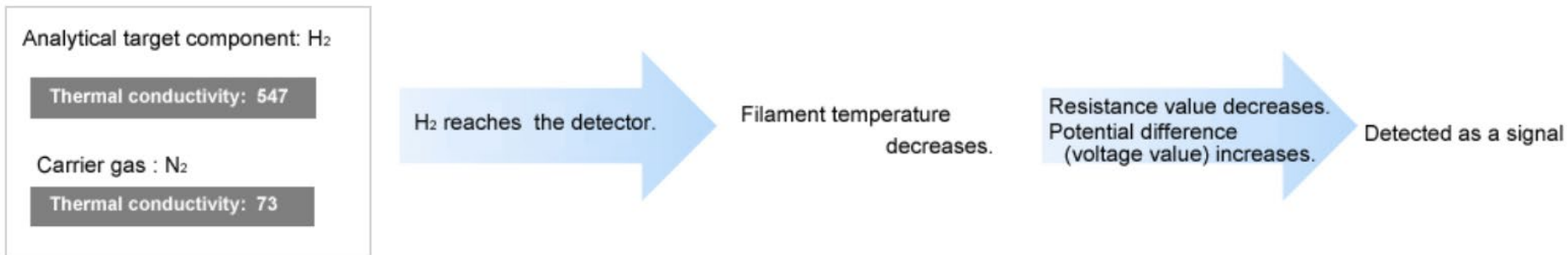

Application

Analysis of permanent gases and gas content within natural gas and refinery gas.

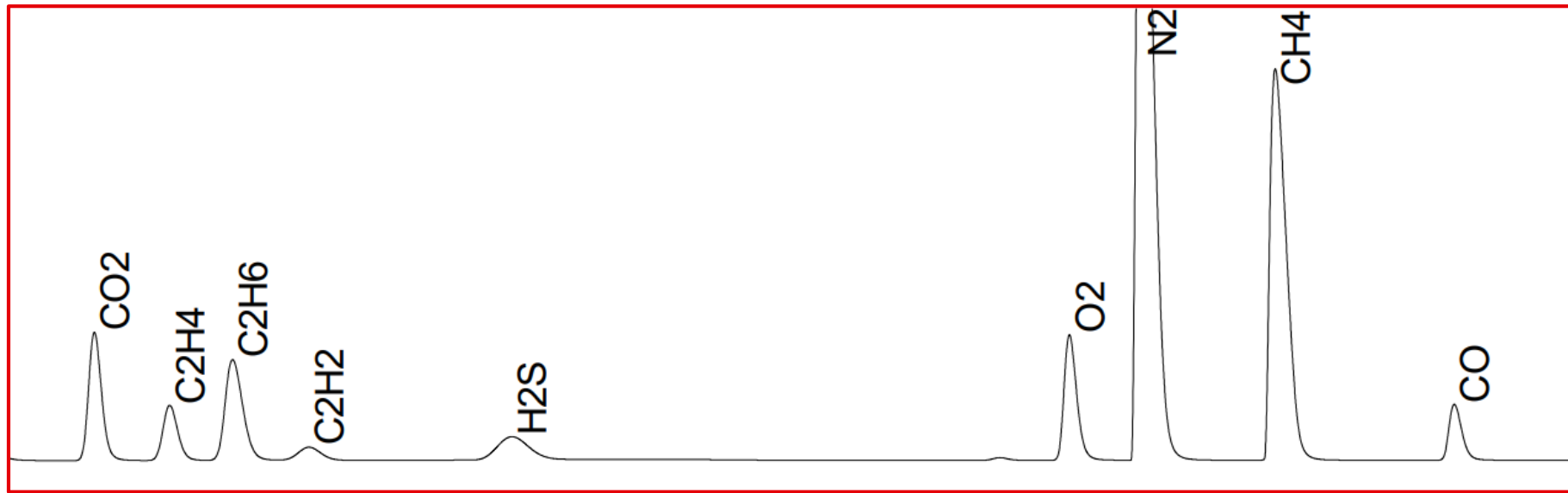

Considerations

Sensitivity is poor.

Thermal Conductivity Constant must be significantly different for a good response.

Cannot detect carrier gas.

Cannot detect H₂ with He carrier.

N₂ is a poor carrier option for low-level permanent gas analysis.

Response impacted by flow rate.

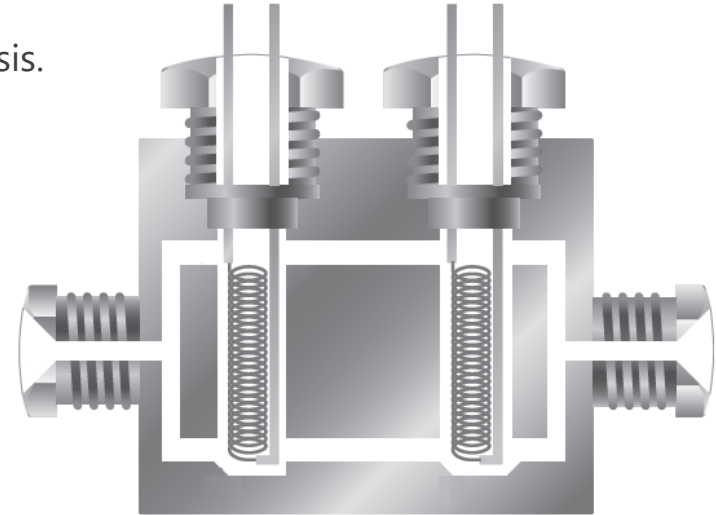

Barrier Discharge Ionisation Detector (BID)

Barrier Discharge Ionisation Detector (BID)

Unique detector for high-sensitivity, universal analysis.

Combines sensitivity of FID* with universal detection of TCD.

* *sensitivity is actually around 2x FID.*

Specificity	Universal (except He & Ne)
Sensitivity	0.05 ppm [0.05 ng]
Dynamic range	10^5
Detector type	Mass detector
Properties	Destructive

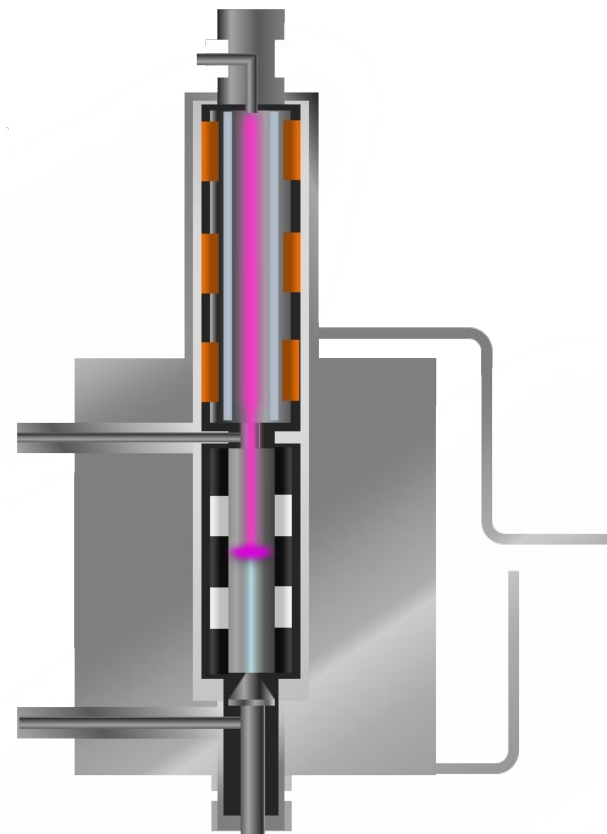

Fundamentals

Helium is used to form a plasma inside a quartz tube.

Plasma transfers energy to analytes, ionising them.



Signal generated by collector electrodes.

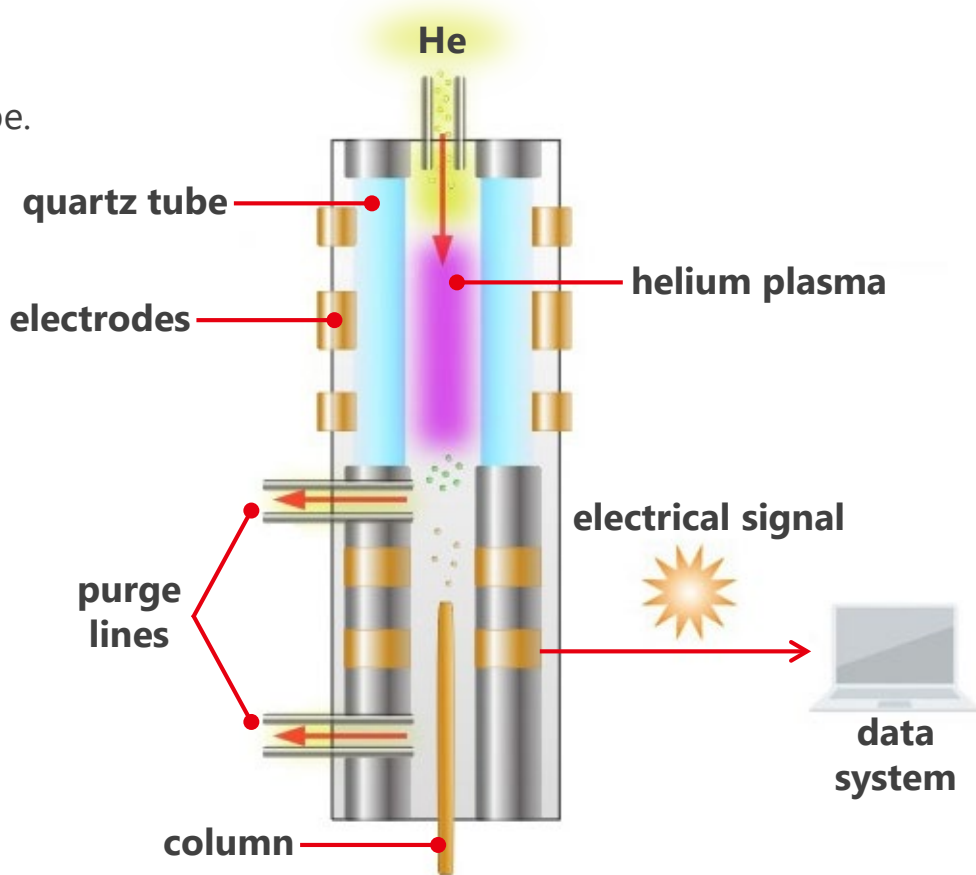

Application

Low-level analysis of analytes incompatible with FID, such as formic acid, acetaldehyde, & water.

Low-level permanent gas analysis.

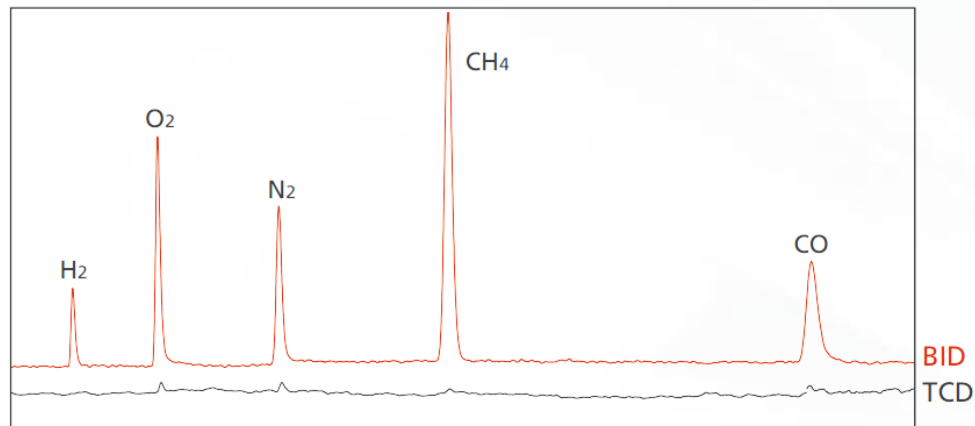
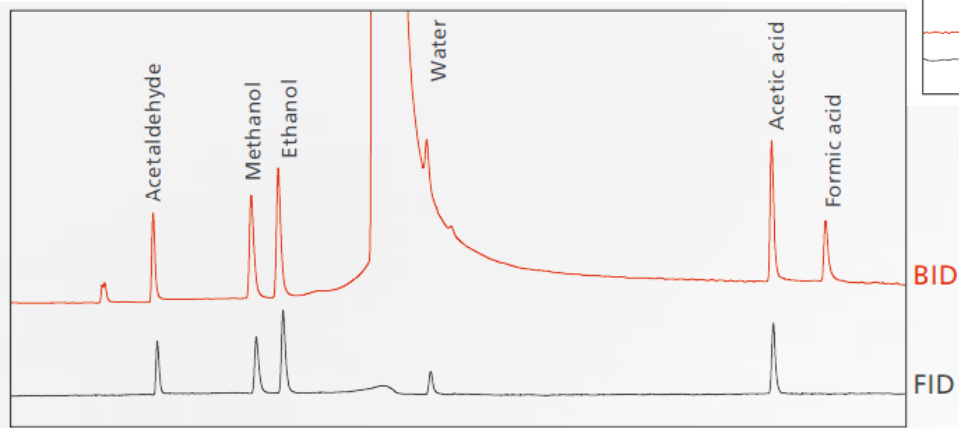

Considerations

Requires high-purity helium for detector gas and carrier gas supply.

Takes time to stabilise on power-up.

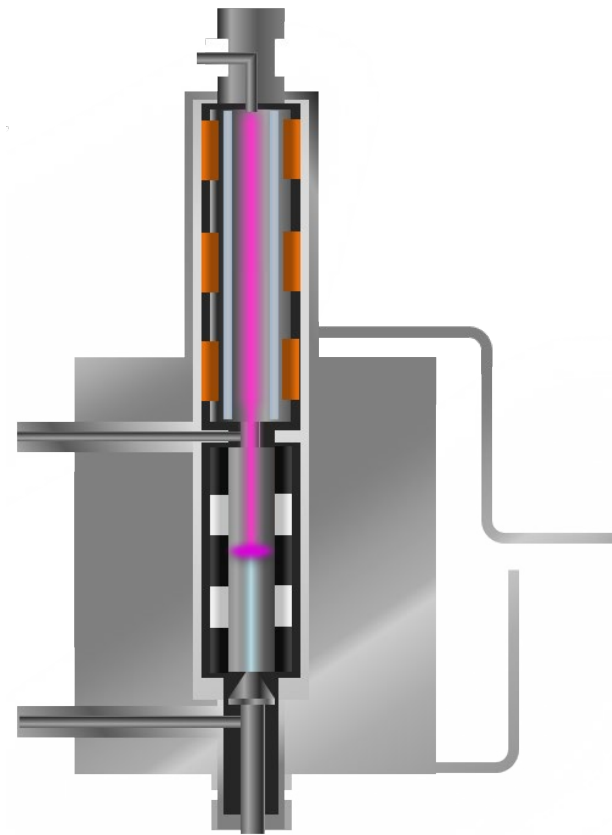

Selective, high-sensitivity detectors



Flame Photometric Detector (FPD)

Fundamentals

Analytes are burned in same way as FID.

Those containing S, P & Sb emit light after excitation from burning.

Emitted light is at specific wavelengths for each element.

Emitted light is filtered to enable transmission to photomultiplier, which generates signal.

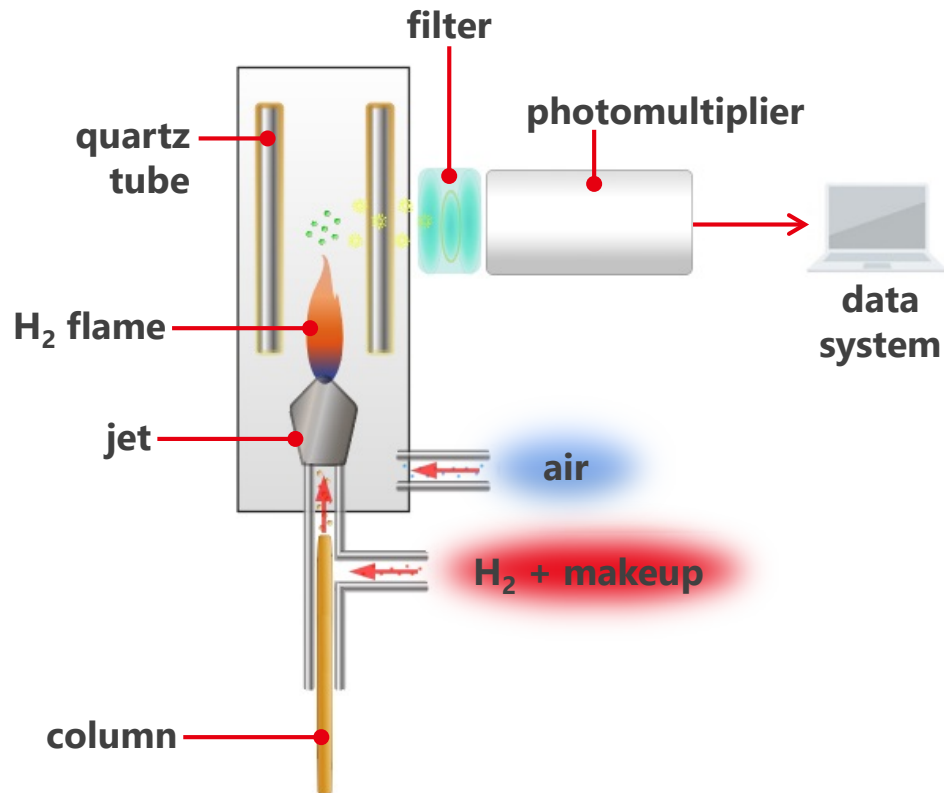

Considerations

Sulfur is in its diatomic state, so the FPD gives a square law response.
If concentration doubles, signal response quadruples.

Carbon quenching can reduce response.

Same gas requirements as FID (hydrogen, air & make-up gas).

Can only detect one element at a time!

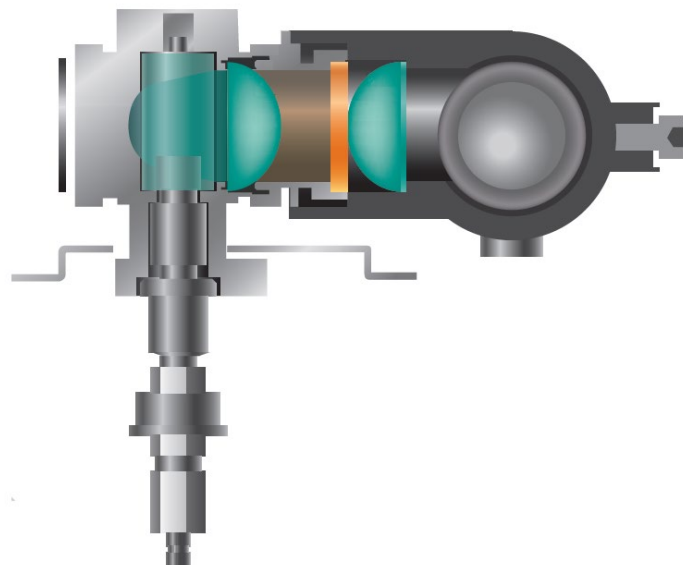

Sulfur Chemiluminescence Detector (SCD)

Sulfur Chemiluminescence Detector (SCD)

Similar to FPD – it detects sulfur.

Different from FPD:

- Higher sulfur selectivity
- Higher sensitivity
- Higher linearity
- Equimolarity

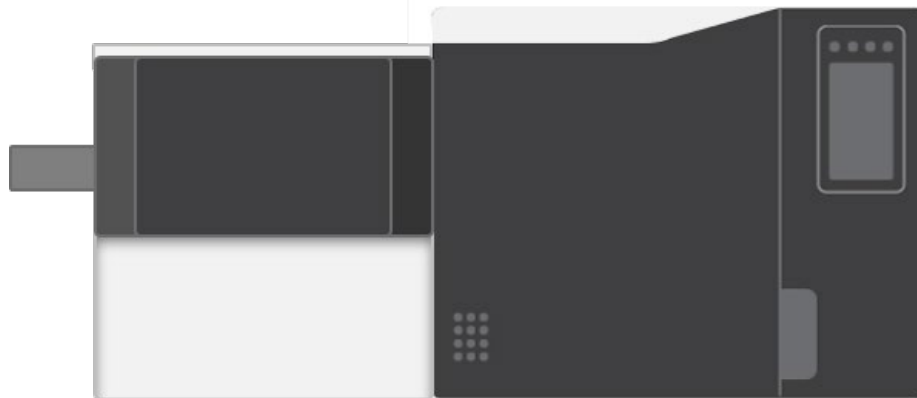

Specificity	Selective (sulfur)
Sensitivity	1 ppb [1 pg]
Dynamic range	10^6
Detector type	Mass detector
Properties	Destructive

Fundamentals

Furnace

Oxidation to SO_2 (using O_2)
 Reduction to SO (using H_2)

Reaction chamber

Oxidation to SO_2^* (using O_3)
 Decays to SO_2
 Light emitted (300-400 nm)

Vacuum system

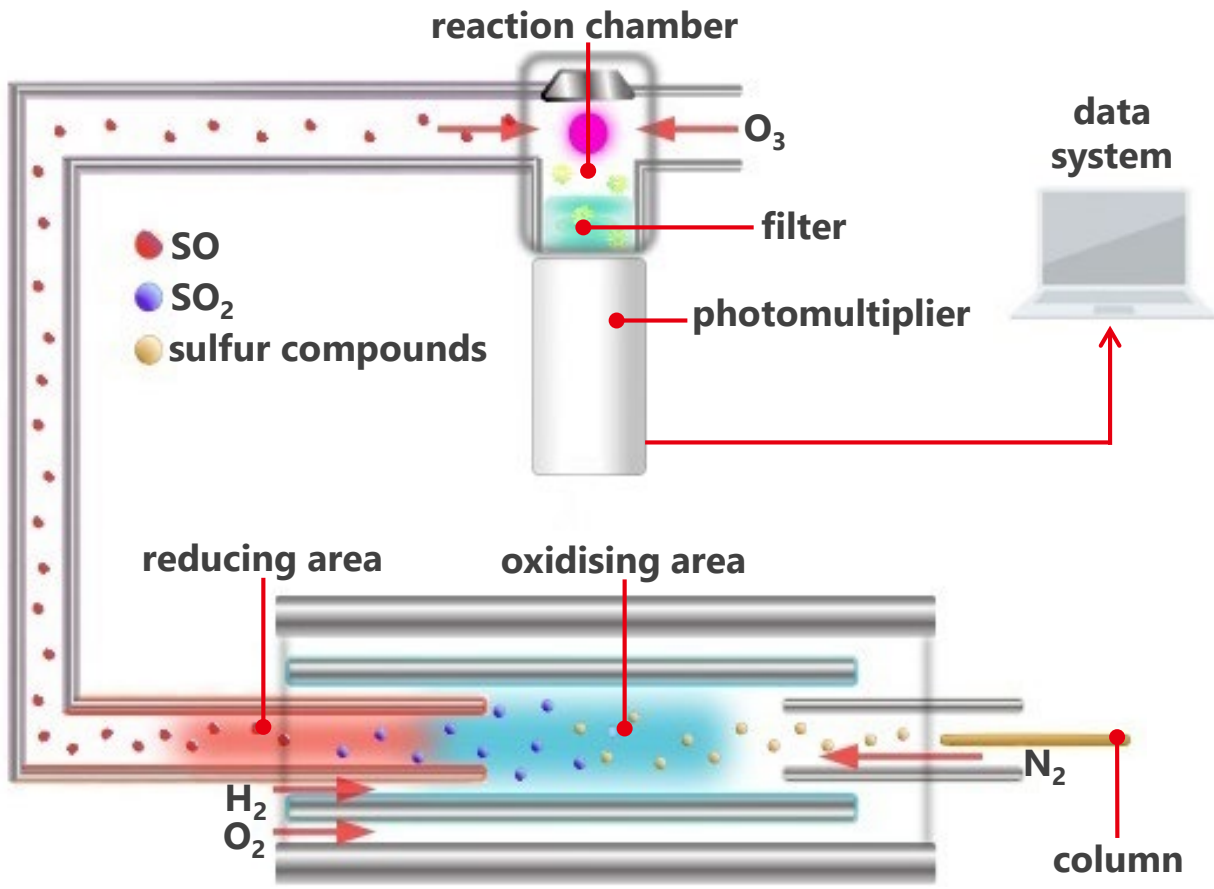

Applications

Trace sulfur affecting taste and flavour profiles of food & beverage.

Sulfur impurities in feedstocks.

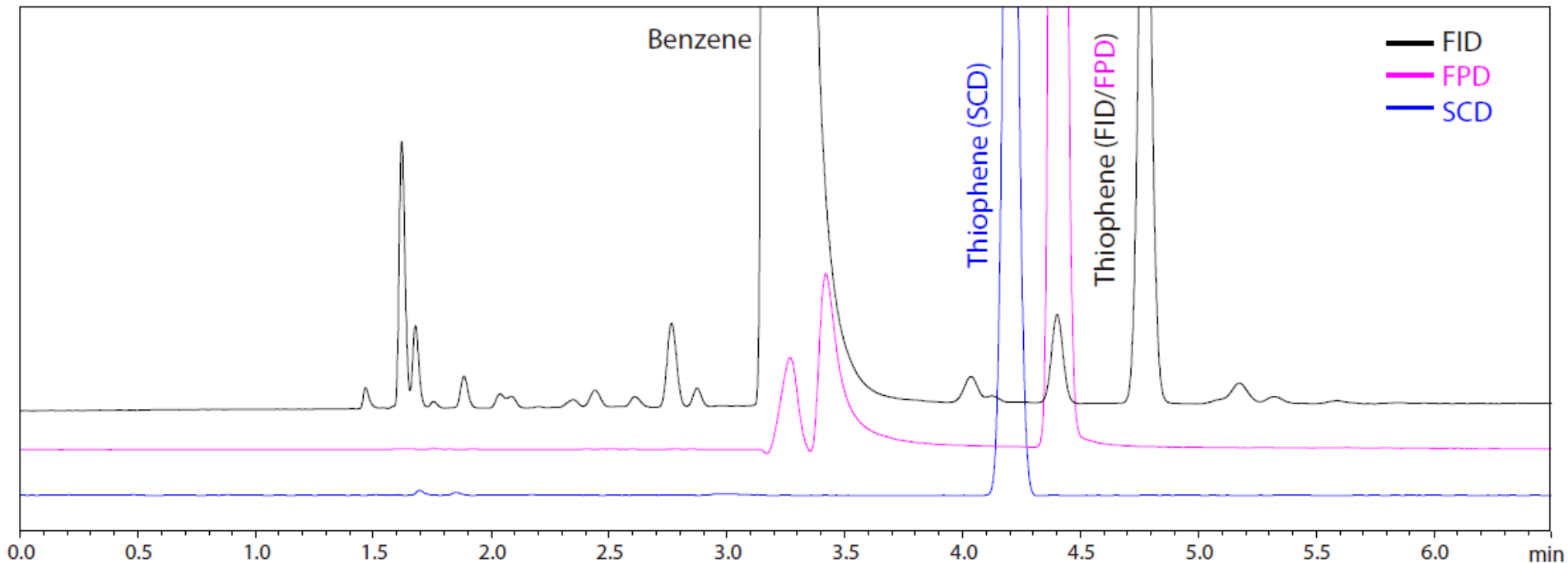

Considerations

Larger instrument footprint than standard GC system.

Higher maintenance requirements.

Long stabilisation times.

Requires hydrogen and oxygen gases.

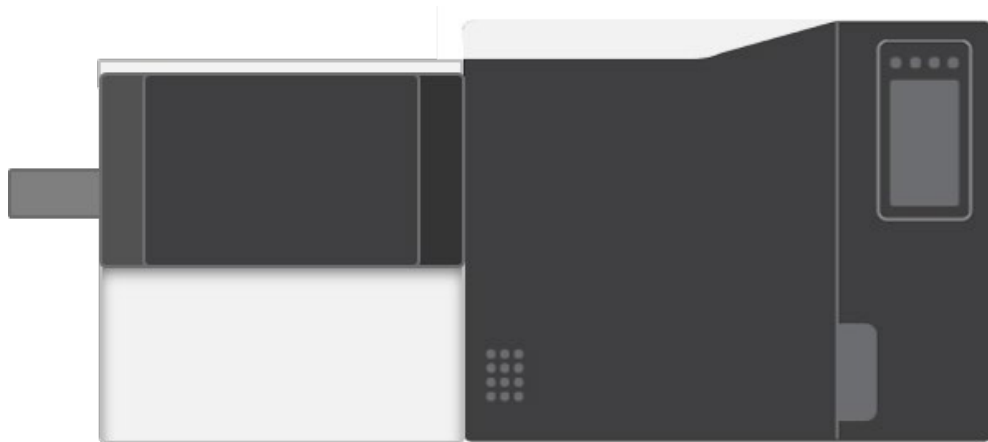

Electron Capture Detector (ECD)

Electron Capture Detector (ECD)

The ECD is used primarily for the analysis of halogenated species.

Specificity	Selective (electrophilic compounds)
Sensitivity	0.01 ppb [0.01 pg]
Dynamic range	10^5
Detector type	Concentration detector
Properties	Non-destructive

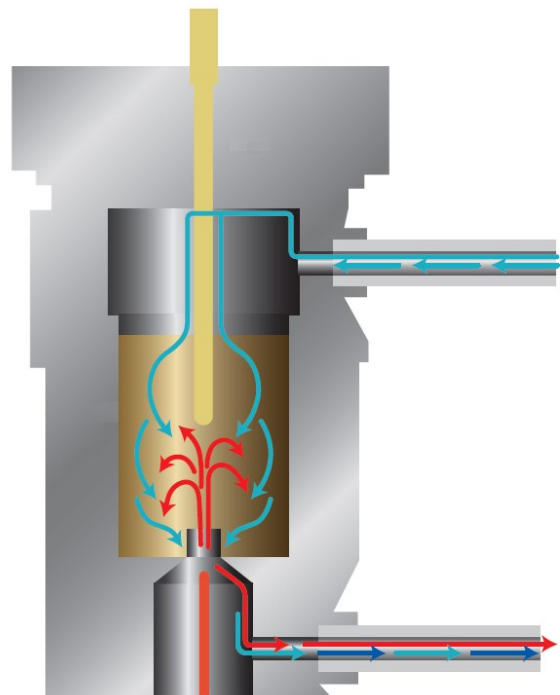

Fundamentals

Radioactive detector, emitting beta rays.

Nitrogen make-up gas is ionised.



Electrophilic compounds, like PCBs, pick up e^- .

Standing current drops, generating signal.

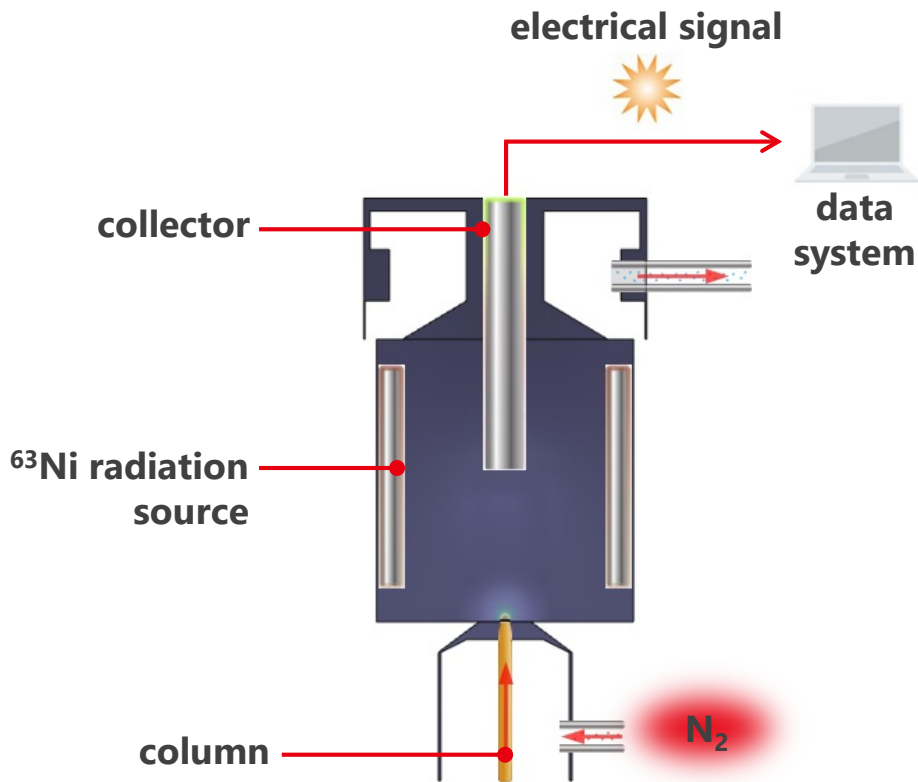

Applications

PCBs in transformer oil.

Low-level analysis of halogenated VOCs in water.

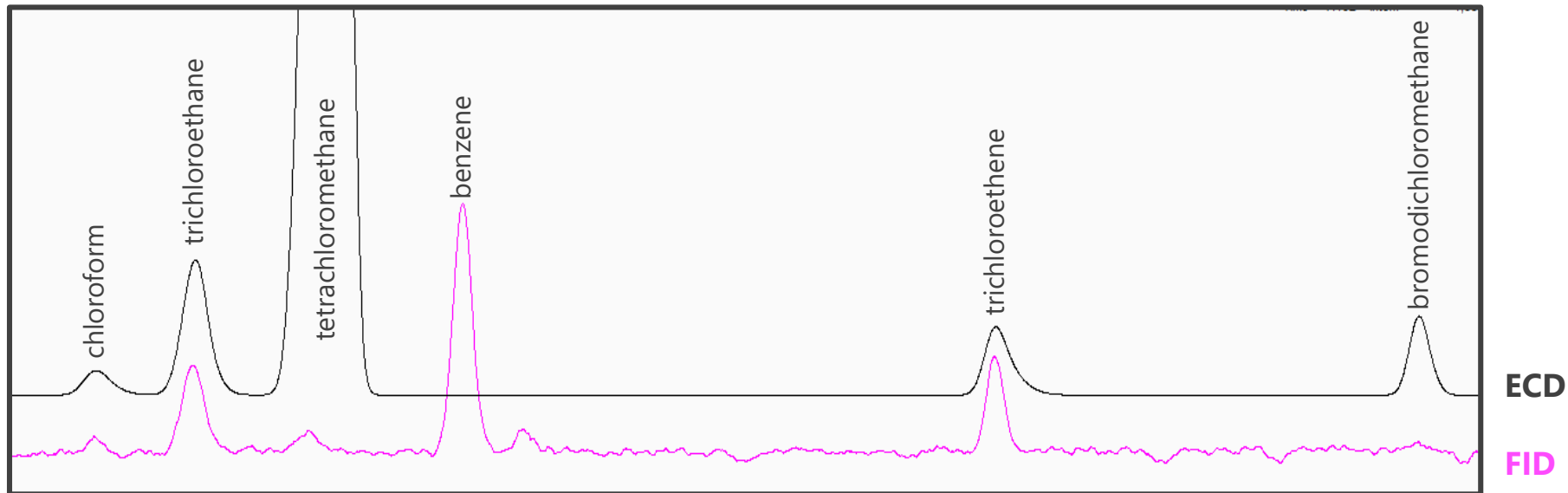

Considerations

Radioactive!!

Saturation can damage detector.

Requires high-purity gases (99.9999%).

Leaks can damage the cell due to oxidation.

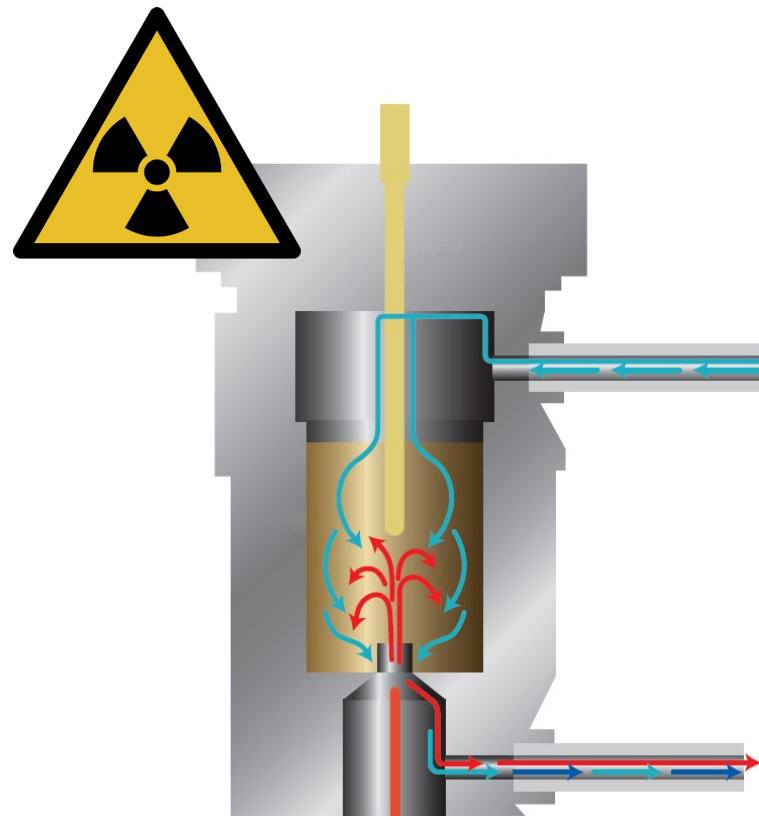

Flame Thermionic Detector (FTD) Nitrogen Phosphorous Detector (NPD)

Flame Thermionic Detector (FTD)

Used for the analysis of nitrogen- and phosphorous-containing compounds.

Common applications include drug and pesticide analysis.

Specificity	Selective (nitrogen & phosphorous)
Sensitivity	0.1 ppb [0.1 pg] (P) 1 ppb [1 pg] (N)
Dynamic range	10^7
Detector type	Mass detector
Properties	Destructive

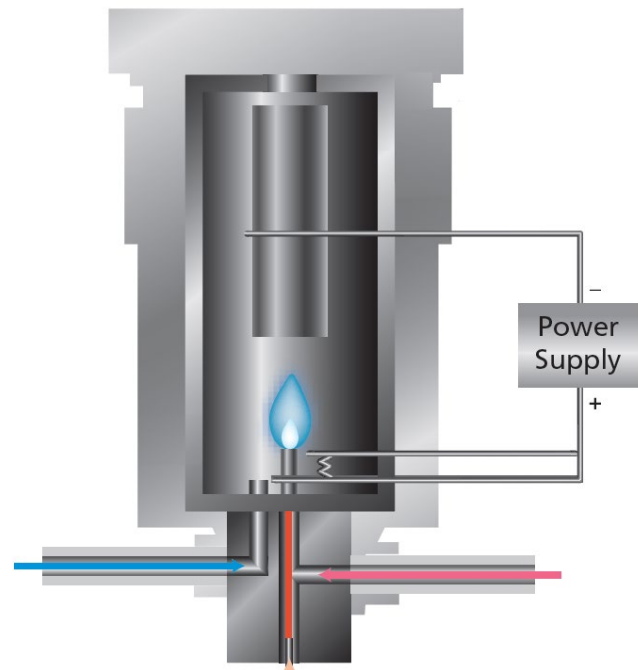

Fundamentals

Analytes burnt in hydrogen flame, like FID & FPD.

Electrically-heated alkaline bead generates plasma.



Ions are collected to generate electric current.

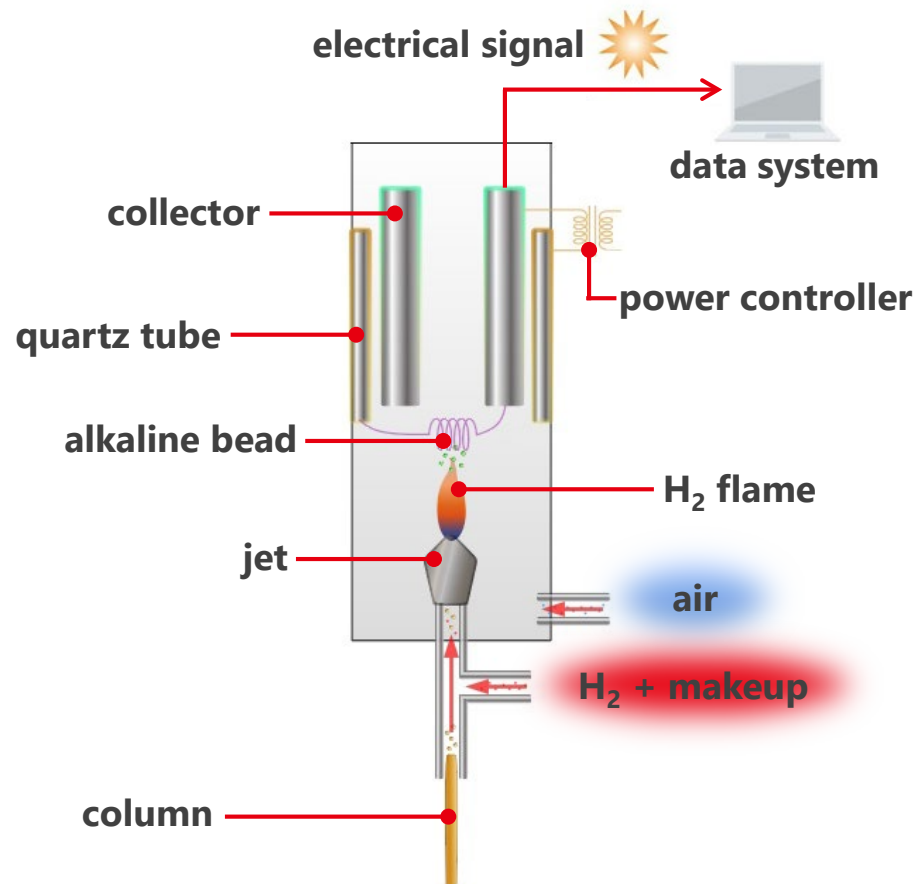

Considerations

Requires hydrogen, air & make-up gases.

Can't analyse inorganic nitrogen species (incl. ammonia).

Bead requires periodic replacement.

Detector stability is lower than other detectors.
Requires frequent re-calibration.

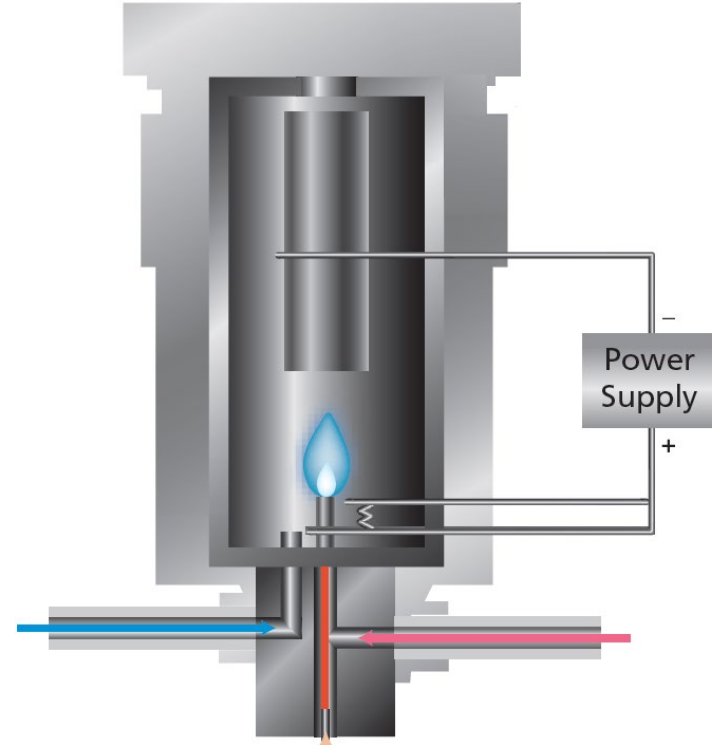

Mass Spectrometry (MS)



Mass Spectrometer (MS)

Widely used for high-sensitivity analysis and analysis of unknown compounds.

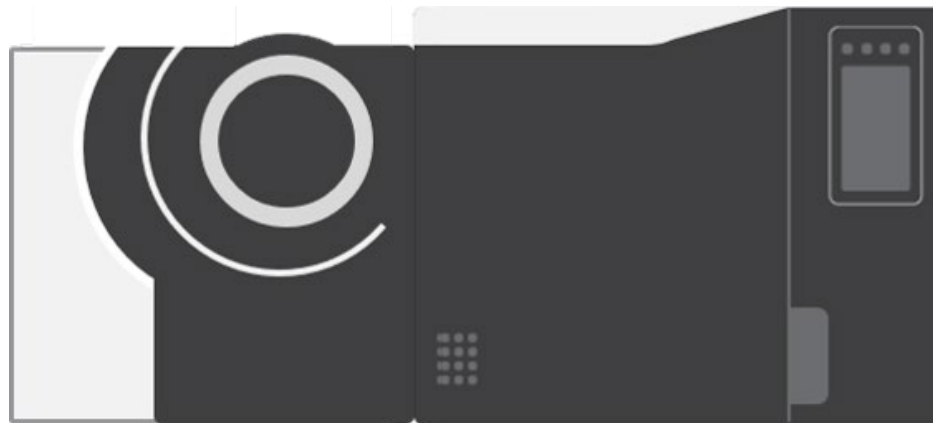

Specificity	Universal, mostly
Sensitivity	<ppt – ppm (<fg – ng), depending on type
Dynamic range	10^{2-6} , depending on type

Summary



Comparison

	<u>Selectivity</u>	<u>Sensitivity</u>	<u>Dynamic Range</u>	
FID	Universal (C-H or C-N)	0.1 ppm	10^7	} Universal
TCD	Universal (except carrier gas)	10 ppm	10^7	
BID	Universal (except He & Ne)	0.05 ppm	10^6	
MS	<i>Universal</i>	<i>< ppt - ppm</i>	10^{2-6}	
FPD	S, P & Sb	10 ppb	10^2	} Selective
SCD	S	1 ppb	10^6	
ECD	Electrophilic	0.01 ppb	10^5	
FTD	N & P	1 ppb [N] 0.1 ppb [P]	10^6	

Summary

- **Detector properties (sensitivity, dynamic range & selectivity) vary considerably.**
- **Detector sensitivity is often defined by minimum detectable quantities (MDQ).**
 - Sensitivity can also be expressed as:
 - Method detection limit (MDL)
 - Limit of detection (LOD)
 - Limit of quantitation (LOQ)
 - Signal-to-noise (S/N or SNR)
- **Detectors have a dynamic range, where a change in sample amount/concentration alters signal response.**
 - Beyond the dynamic range, changes in amount/concentration are not seen by the detector.
 - Linear dynamic range (LDR) is the range where a linear increase in amount/concentration, has linear increase in response.
- **Detectors can be universal or selective.**
 - Selective detectors can improve sensitivity by removing matrix interference.
 - Universal detectors are ideal when information about the full content of sample is required (purity analysis).
- **Choosing the right detector is one of the most important aspects when specifying instrument hardware.**
- **Common GC detectors include: FID, TCD, BID, FPD, SCD, ECD, FTD & MS**

Next time

The next session will be on...

Data Processing

This will cover:

- *Qualitative analysis*
- *Quantitative analysis*
- *Sample types (standards, unknowns, etc.)*
- *Compound types (surrogates, internal standards, etc.)*

Shimadzu UK e-News

Join our e-News mailing list today!

Benefits of joining:

- Be entered into our prize draws & competitions
- Find out about our latest webinars, workshops & events
- Receive exciting information about the latest analytical technology & application notes

Look for the link in our follow-up email or go to www.shimadzu.co.uk and click on e-News



Shimadzu UK Limited
Analytical and Measuring Instruments

 E-NEWS  CONTACT  GLOBAL

[HOME](#)[ABOUT US](#)[PRODUCTS](#)[INDUSTRIES](#)[LITERATURE](#)[SUPPORT](#)[NEWS / EVENTS](#)

Shimadzu UK webinars

Please visit our website to check out our other webinar sessions that are open for registration or are available on demand:

www.shimadzu.co.uk/webinars



SHIMADZU

Excellence in Science

UK Contact Details

www.shimadzu.co.uk

info@shimadzu.co.uk

01908 552209



@ShimadzuUK



Shimadzu UK Limited

Thank you for your attention!



SHIMADZU

Excellence in Science

Global Contact Details

www.shimadzu.com/an/



Global
Analytical and Measuring Instruments

 [ABOUT SHIMADZU](#)

 [CONTACT US](#)

 [CONTACT SEARCH](#)

