

GC/MS solutions that help analytical labs
see more, further, and faster

Staying Ahead in a Rapidly Changing World

Application Compendium



Table of Contents

Introduction	3
Analysis of Semivolatile Organic Compounds Using Hydrogen Carrier Gas and HydroInert Ion Source by Gas Chromatography/Mass Spectrometry	4
Analysis of Semivolatile Organic Compounds with Hydrogen Carrier Gas and HydroInert source by Gas Chromatography–Triple Quadrupole Mass Spectrometry (GC-MS/MS)	20
Volatile Organic Compounds Analysis in Drinking Water with Headspace GC/MSD using Hydrogen Carrier Gas and HydroInert Source	36
Analysis of Semivolatile Organic Compounds with US EPA 8270E Using the Agilent 7000E Triple Quadrupole GC/MS	49
Five Keys to Unlock Maximum Performance in the Analysis of Over 200 Pesticides in Challenging Food Matrices by GC/MS/MS	64
Dynamic MRM/Scan Mode: Adding More Confidence to Sensitive Quantitation in Complex Foods by GC/TQ	80
A Fast and Robust GC/MS/MS Analysis of 203 Pesticides in 10 Minutes in Spinach	94
Analysis of Pesticides in Kale Using the Agilent 7010C Triple Quadrupole GC/MS with Agilent Bond Elut QuEChERS High Pigment dSPE with Carbon S Cleanup	109

Maximize your laboratory's revenue with new Agilent GC/MS solutions

Increased pressure on the world's food, water, and soil resources has led to heightened scrutiny and tighter regulation of potential contaminants as a means of ensuring safety and sustainability. This in turn places new demands on the analytical tools and methods used to reliably identify and quantify those contaminants.

Agilent continues to innovate its industry-leading gas chromatography/mass spectrometry (GC/MS) solutions and methodology to ensure that analytical labs remain equipped to meet these challenges. This compendium gathers key application notes that detail new approaches for carrying out essential analyses of contaminants of interest in soil, water, and a range of complex food samples.



5977C GC/MSD



7000E Triple Quadrupole GC/MS



7010C Triple Quadrupole GC/MS

Analysis of Semivolatile Organic Compounds Using Hydrogen Carrier Gas and the Agilent HydroInert Source by Gas Chromatography/Mass Spectrometry

Author

Angela Smith Henry, PhD
Agilent Technologies, Inc.

Abstract

Gas chromatography/mass spectrometry (GC/MS) is integral to the analysis of semivolatile organic compounds (SVOCs) in environmental matrices. Recent pressure on the helium (He) supply has required organizations to actively investigate hydrogen (H₂) carrier gas, but most GC/MS analyses have reduced sensitivity and hydrogenation or dechlorination in the sources. The Agilent HydroInert source retains the ability to analyze a wide calibration range (0.1 to 100 µg/mL) and meet the U.S. Environmental Protection Agency (EPA) method 8270 calibration criteria when using H₂ carrier gas.

Introduction

GC/MS is regarded as the select analytical technique for the analysis of SVOCs. Governmental regulatory authorities have established methods and performance criteria for the measurement of SVOCs identified as pollutants in environmental and industrial matrices. For example, the U.S. EPA method 8270 (versions 8270D and 8270E) contains a list of over 200 compounds suitable for analysis by GC/MS in solid waste, soil, air, and water extracts.^{1,2} Method 8270 contains SVOCs across several analyte class types from acids, bases, neutral compounds, and polyaromatic hydrocarbons (PAHs); this method also has detailed specifications and requirements for the Quantitative Analysis of SVOCs.

The availability of helium (He) has been a concern for several years, but interest in transitioning to alternative carrier gases, such as hydrogen (H₂) has significantly increased in recent years. However, existing MS systems have issues with hydrogenation of some functional groups, such as nitro compounds, or dechlorination of heavily chlorinated compounds; these issues would alter the mass spectra of a peak in the total ion chromatogram (TIC) and lead to potential misidentification of compounds. A newly designed extractor source for the Agilent 5977B Inert Plus GC/MSD addresses these H₂-related issues and helps improve performance with H₂ carrier gas in GC/MS. The Hydrolnert source with H₂ carrier gas retains mass spectral fidelity and can allow users to continue to use existing He-based mass spectral libraries and quantitative methods.

This application note demonstrates the ability of the Hydrolnert source to allow the use of H₂ carrier gas, while retaining critical functional groups, such as nitro groups and halogens. Retention of mass spectral fidelity is a breakthrough for the use of H₂ carrier gas with GC/MS systems, especially for environmental analyses such as EPA method 8270. Also, a method for EPA 8270 has been developed that retains similar sensitivity to a He carrier gas analysis, which allows for most compounds to be calibrated between 0.1 to 100 µg/mL with fewer than 20% of compounds requiring linear curve fits.

Experimental

A set of stock standards containing 119 target compounds and surrogates was selected to provide a representative mixture of acids, bases, and neutral compounds, as well as comprising various compound classes, from nitrophenols to PAHs. The nine stock standards of target analytes were at concentrations of 2,000 µg/mL; part numbers for these stock standards are as follows: SVM-160, SVM-121, SVM-122, SVM-123, SVM-124, SVM-125, SVM-126-1, SVM-127, and US-211. Pyridine was diluted from a pure standard to 1,000 µg/mL as a working standard. The surrogate standard (part number ISM-332) contained six compounds at 2,000 µg/mL, indicated in Table 1. An internal standard mixture of six deuterated PAHs (part number ISM-560) was used for recovery and calibration. The stock standards were combined and diluted in dichloromethane to make a working standard at 200 µg/mL. The working standard was then diluted to form the following nominal concentrations for the targets and surrogates for calibration standards: 0.1, 0.2, 0.5, 0.8, 1, 2, 5, 10, 20, 35, 50, 75, and 100 µg/mL. Internal standards were added to each calibration standard at a concentration level of 40 µg/mL. Table 1 lists the compounds that were used in the study. The compound numbers in Table 1 were assigned based on the retention order of the targets and surrogates, with the internal standards listed at the end of the table out of the retention order.

The tuning standard (part number GCM-150), containing a mixture of benzidine, pentachlorophenol, 4,4'-dichlorodiphenyltrichloroethane (4,4'-DDT), and decafluorotriphenylphosphine (DFTPP), was diluted to 25 µg/mL and used to obtain the MS calibration and tuning settings.

A composite mixture of soils extracted with dichloromethane was prepared for EPA method 8270 analysis. The mixture was a representative matrix residue that is typically encountered in the lab and was procured from Pace Analytical (Mt. Juliet, TN).

Table 1. Target, surrogates, and internal standards.

No.	Compound	No.	Compound	No.	Compound
1	N-Nitrosodimethylamine	43	4-Chloro-3-methylphenol	85	Pentachlorophenol
2	Pyridine	44	2-Methylnaphthalene	86	Pentachloronitrobenzene
3	2-picoline	45	Hexachlorocyclopentadiene	87	Propyzamide
4	N-Nitroso-N-methylethylamine	46	1,2,4,5-Tetrachlorobenzene	88	Dinoseb
5	Methyl methanesulfonate	47	2,4,6-Trichlorophenol	89	Disulfoton
6	2-Fluorophenol	48	2,4,5-Trichlorophenol	90	Phenanthrene
7	N-Nitrosodiethylamine	49	2-Fluorobiphenyl (surrogate)	91	Anthracene
8	Ethyl methanesulfonate	50	2-Chloronaphthalene	92	Methyl parathion
9	Phenol-d ₆ (surrogate)	51	1-Chloronaphthalene	93	Dibutyl phthalate
10	Phenol	52	2-Nitroaniline	94	Parathion
11	Aniline	53	Dimethyl phthalate	95	4-Nitroquinoline-1-oxide
12	Bis(2-chloroethyl) ether	54	2,6-Dinitrotoluene	96	Fluoranthene
13	2-Chlorophenol	55	Acenaphthylene	97	Benzidine
14	1,3-Dichlorobenzene	56	<i>m</i> -Nitroaniline	98	Pyrene
15	1,4-Dichlorobenzene	57	Acenaphthene	99	Aramite
16	Benzyl alcohol	58	2,4-Dinitrophenol	100	<i>p</i> -Terphenyl-d ₁₄ (surrogate)
17	1,2-Dichlorobenzene	59	4-Nitrophenol	101	Aramite II
18	2-Methylphenol (<i>o</i> -cresol)	60	Pentachlorobenzene	102	<i>p</i> -(Dimethylamino)azobenzene
19	Bis(2-chloro-1-methylethyl) ether	61	2,4-Dinitrotoluene	103	Chlorobenzilate
20	1-Nitrosopyrrolidine	62	Dibenzofuran	104	3,3'-Dimethylbenzidine
21	<i>p</i> -Cresol	63	1-Naphthalenamine	105	Benzyl butyl phthalate
22	N-Nitrosodi- <i>n</i> -propylamine	64	2,3,4,6-Tetrachlorophenol	106	3,3'-Dichlorobenzidine
23	Acetophenone	65	2-Naphthalenamine	107	Benz[a]anthracene
24	4-Nitrosomorpholine	66	Diethyl phthalate	108	Chrysene
25	<i>o</i> -Toluidine	67	Thionazin	109	Bis(2-ethylhexyl) phthalate
26	Hexachloroethane	68	Fluorene	110	Di- <i>n</i> -octyl phthalate
27	Nitrobenzene-d ₅ (surrogate)	69	4-Chlorophenyl phenyl ether	111	7,12-Dimethylbenz[a]anthracene
28	Nitrobenzene	70	5-Nitro- <i>o</i> -toluidine	112	Benzo[b]fluoranthene
29	N-Nitrosopiperidine	71	4-Nitroaniline	113	Benzo[k]fluoranthene
30	Isophorone	72	2-Methyl, 4,6-dinitrophenol	114	Benzo[a]pyrene
31	2-Nitrophenol	73	Diphenylamine	115	3-Methylcholanthrene
32	2,4-Dimethylphenol	74	Azobenzene	116	Dibenz[a,j]acridine
33	Benzoic acid	75	2,4,6-Tribromophenol	117	Indeno(1,2,3- <i>cd</i>)pyrene
34	Bis(2-chloroethoxy)methane	76	Sulfotep	118	Dibenz[a,h]anthracene
35	2,4-Dichlorophenol	77	Diallate I	119	Benzo[ghi]perylene
36	1,2,4-Trichlorobenzene	78	Diallate II	120	1,4-Dichlorobenzene-d ₄ (internal standard)
37	Naphthalene	79	Phorate	121	Naphthalene-d ₈ (internal standard)
38	<i>a,a</i> -Dimethylphenethylamine	80	Phenacetin	122	Acenaphthalene-d ₁₀ (internal standard)
39	<i>p</i> -Chloroaniline	81	4-Bromophenyl phenyl ether	123	Phenanthrene-d ₁₀ (internal standard)
40	2,6-Dichlorophenol	82	Hexachlorobenzene	124	Chrysene-d ₁₂ (internal standard)
41	Hexachlorobutadiene	83	Dimethoate	125	Perylene-d ₁₂ (internal standard)
42	N-nitrosodibutylamine	84	4-Aminobiphenyl		

Instrumental methods

The Agilent 8890 GC system was configured with an Agilent J&W DB-5ms Ultra Inert column (part number 121-5523UI) interfaced with an Agilent 5977B Inert Plus MS system with an Agilent HydroInert source. Table 2 summarizes the GC/MS instrumentation and consumables used in this study. The GC and MSD method parameters (Table 3) have been optimized to provide a 12-minute method, while retaining the required resolution for isomer pairs and following the EPA method 8270 guidelines for method parameters, such as scan range and scan rate.

Instrumentation

Table 2. GC and MSD instrumentation and consumables.

Parameter	Value
GC	Agilent 8890 GC system
MS	Agilent 5977B Inert Plus GC/MSD
Source	Agilent HydroInert source with 9 mm HydroInert extraction lens
Syringe	Agilent Blue Line autosampler syringe, 10 μ L, PTFE-tip plunger (part number G4513-80203)
Column	Agilent DB-5ms Ultra Inert, 20 m \times 0.18 mm, 0.36 μ m (part number 121-5523UI)
Inlet Liner	Agilent Ultra Inert inlet liner, split, low pressure drop, glass wool (part number 5190-2295)

Instrument conditions

Table 3. GC and MSD instrument conditions.

Parameter	Value
Injection Volume	1 μ L
Inlet	230 °C Split 10:1
Column Temperature Program	40 °C (0 min hold) 30 °C/min to 320 °C (hold 2 min)
Carrier Gas and Flow Rate	H ₂ , 1.2 mL/min constant flow
Transfer Line Temperature	320 °C
Ion Source Temperature	300 °C
Quadrupole Temperature	150 °C
Scan	35 to 500 <i>m/z</i>
Tune	etune.u
Gain Factor	0.5
Threshold	0
A/D Samples	4

Method development

Switching carrier gas from He to H₂ introduced several challenges for EPA method 8270 analyses with a GC/MS single quadrupole instrument. Balance between sensitivity changes, inlet pressure and flow rates, and column capacity and dimensions must be managed to attain the required calibration range of 0.1 to 100 μ g/mL for most compounds. For example, if the typical EPA method 8270 analysis with He carrier gas used a 30 m \times 0.25 mm, 0.25 μ m DB-5ms Ultra Inert column was changed to use a 20 m \times 0.18 mm, 0.18 μ m DB-5ms Ultra Inert column for H₂ carrier gas, this 20 m column would have ~33% of the 30 m column capacity, requiring changes to the injection parameters to avoid column overload. However, when a 20:1 split injection was used, limitations in sensitivity were observed with issues of reaching below 0.5 μ g/mL injected concentration (25 ng/mL on column); using etune.u did not solve the issue. Another investigated method used the 30 m \times 0.25 mm, 0.25 μ m DB-5ms Ultra Inert column with a pulsed splitless injection and 1.5 mL/min flow rate. This method could reach the 0.1 μ g/mL lower-end concentration for most compounds but had issue with severely fronting peaks above ~75 μ g/mL, indicating overload, which also caused an increase in linear fits. A pulsed split injection with 10:1 split was tested for the 30 m column method with an atune.u tune, but most compounds were not detected at 0.1 μ g/mL. For the column referenced in this work (20 m \times 0.18 mm, 0.36 μ m DB-5ms Ultra Inert), various injection parameters and both atune and etune algorithms were tested. The final method parameters listed in Table 3 provided the best balance between column capacity, sensitivity, and ability to produce calibration results in the 0.1 to 100 μ g/mL range. While atune would be preferred, the lowest concentration tended to end at 0.2 μ g/mL for most of the compounds.

Results and discussion

Mass spectral fidelity

A major concern with H₂ carrier gas is changes in the mass spectra of nitro compounds and heavily halogenated compounds. In the presence of H₂, high temperature, and metal surfaces, nitro functional groups are hydrogenated to amines, while heavily chlorinated compounds are dechlorinated; all these factors are present in the mass spectrometer. The following is an example of the benefits of the Hydrolnert source with nitrobenzene. In an experiment with an extractor source with a 3 mm extraction lens, H₂ was used as the carrier gas, where nitrobenzene was one of the compounds in the mixture (part number SVM-122-1). Hydrogenation of nitrobenzene (molecular weight (MW) 123 *m/z*) will form aniline (MW 93 *m/z*). When reviewing the mass spectrum under the TIC peak for the extractor source and H₂ carrier gas, the mass spectrum in Figure 1A was observed. There is a large abundance of 93 *m/z* and low 123 *m/z*, indicating conversion of nitrobenzene to aniline in the source; this is confirmed to occur in the source because the mass spectrum is observed at the retention time of nitrobenzene, which is well separated from aniline. Comparatively, the same mixture containing nitrobenzene was tested on a Hydrolnert source (with a 9 mm extraction lens), where we observe the expected distribution of 123 and 93 *m/z* in the mass spectrum (Figure 1B), indicating that the nitrobenzene is retained in the source and not converted to aniline. This comparison can also be reviewed in the extracted ion chromatograms (EICs) shown in Figure 2A (for the extractor source conversion) and 2B (for Hydrolnert source retention of nitrobenzene), where there is an improved 123/93 ratio using the Hydrolnert source, while the extractor source EIC overlay shows significant conversion to 93 *m/z* and significant tailing.

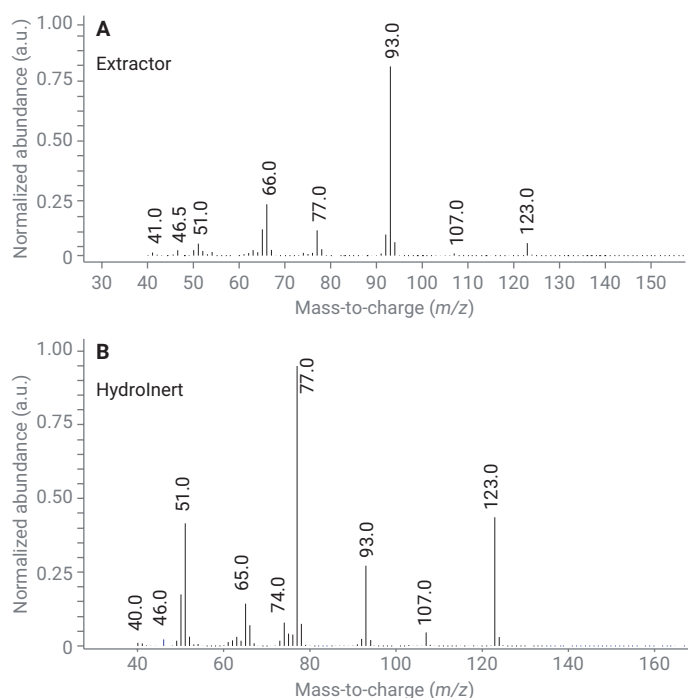

Figure 1. Mass spectra for peak eluting at nitrobenzene retention time with H₂ carrier gas in (A) extractor source with 3 mm extraction lens showing hydrogenation to aniline with the abundant 93 *m/z* ion and (B) Agilent Hydrolnert source, showing an improved mass spectrum that correlates to nitrobenzene.

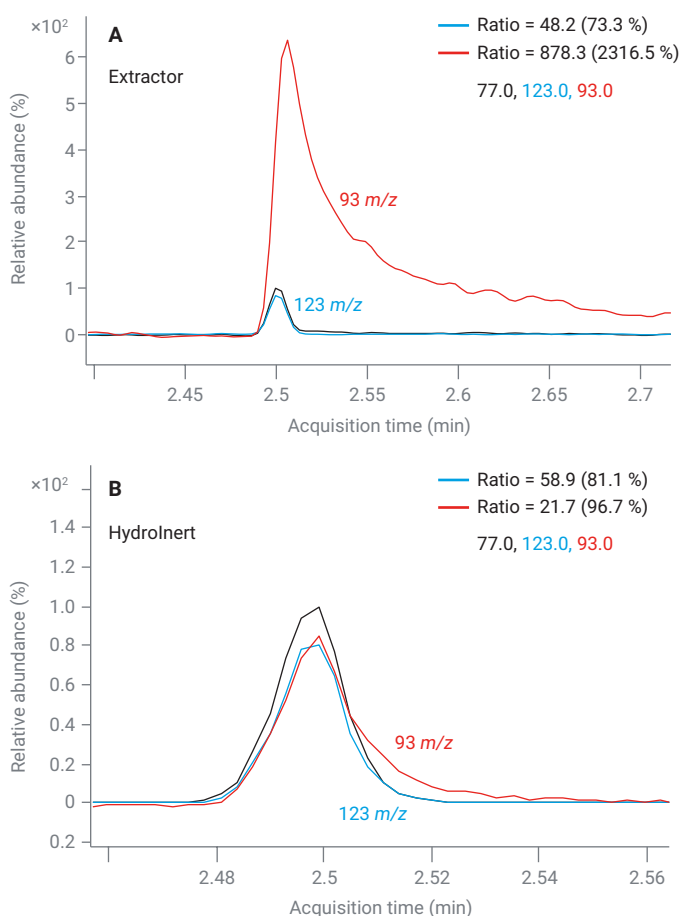

Figure 2. EICs of nitrobenzene with H₂ carrier gas in (A) extractor source with 3 mm extraction lens showing hydrogenation to aniline with the abundant 93 m/z ion and (B) Agilent HydroInert source, showing an improved 123 versus 93 m/z ratio.

GC/MS tuning mix

A critical component of EPA method 8270 is the tune criteria associated with the ion ratios of DFTPP. This method used the etune algorithm for the factor of 10 increase in signal to balance the split injection. For the GC/MS single quadrupole system, the DFTPP ion ratio criteria from Table 3 of EPA methods 8270E and 8270D were used to test the HydroInert source with H₂ carrier gas.^{1,2} The EPA method 8270D includes more ion ratio criteria than EPA 8270E, which reflects the EPA 525 criteria table. Table 4 summarizes the relative abundances of the DFTPP ion ratios at 25 µg/mL, the method criteria, and if the measured relative abundances matched the criteria, where all measured relative abundances pass both the EPA method 8270E and 8270D ion ratio criteria.

Table 4. DFTPP ions, abundance criteria from EPA method 8270D and 8270E^{1,2}, measured relative abundance, and pass/fail of the relative abundance.

Target Mass (m/z)	Ion Abundance Criteria	Measured Relative Abundance	Pass/Fail
51	*10 to 80% of 198 m/z	38.5%	Pass
68	<2% of 69 m/z	1.0%	Pass
69	Present	36.5%	Pass
70	<2% of 69 m/z	0.4%	Pass
127	*10 to 80% of 198 m/z	54.4%	Pass
197	<2% of 198 m/z	0.0%	Pass
198	Base peak or present *or >50% of 442 m/z	51.6%	Pass
199	5 to 9% of 198 m/z	5.0%	Pass
275	10 to 60% of base peak	30.4%	Pass
365	>1% of base peak	4.9%	Pass
441	<150% of 443 m/z present, *but <24% of 442	83.1%, *15.7%	Pass
442	Base peak or present *or >50% of 198 m/z	100% (base peak)	Pass
443	15 to 24% of 442 m/z	18.9%	Pass

* Denotes 8270D requirement difference from EPA method 8270E requirement.

There is always concern for inlet and column cleanliness for EPA method 8270 to work, no matter the carrier gas; DDT, pentachlorophenol, and benzidine are used to track inlet breakdown and column health. Increased DDT breakdown indicates a need for inlet maintenance, while increasing tailing factors of benzidine and pentachlorophenol inform the user to trim or change the column. With the introduction of H₂ carrier gas, users may be worried about increased reactions of active compounds, such as DDT, in the inlet; the recommendation is to lower the inlet temperature to 230 to 250 °C or use a temperature-programmable inlet, such as the multimode inlet to protect the active compounds, while still being able to increase the temperature to 320 °C and drive out the PAHs. This study used the most common inlet existing in laboratories, the split/splitless inlet, and ran the inlet at 230 °C.

Reviewing the results of the GC/MS tuning mixture for DDT breakdown and compound tailing factors, the DDT (%) breakdown was 0.2%, the pentachlorophenol tailing factor was 1.2, and the benzidine tailing factor was 1.3. All values are within the EPA method 8270 criteria of <20% DDT breakdown and tailing factors <2.0.

Calibration criteria

The initial calibration consisted of 13 levels across the concentration range of 0.1 to 100 µg/mL for this 12-minute method. Figure 3 is a TIC of the target analytes, surrogates, and internal standards.

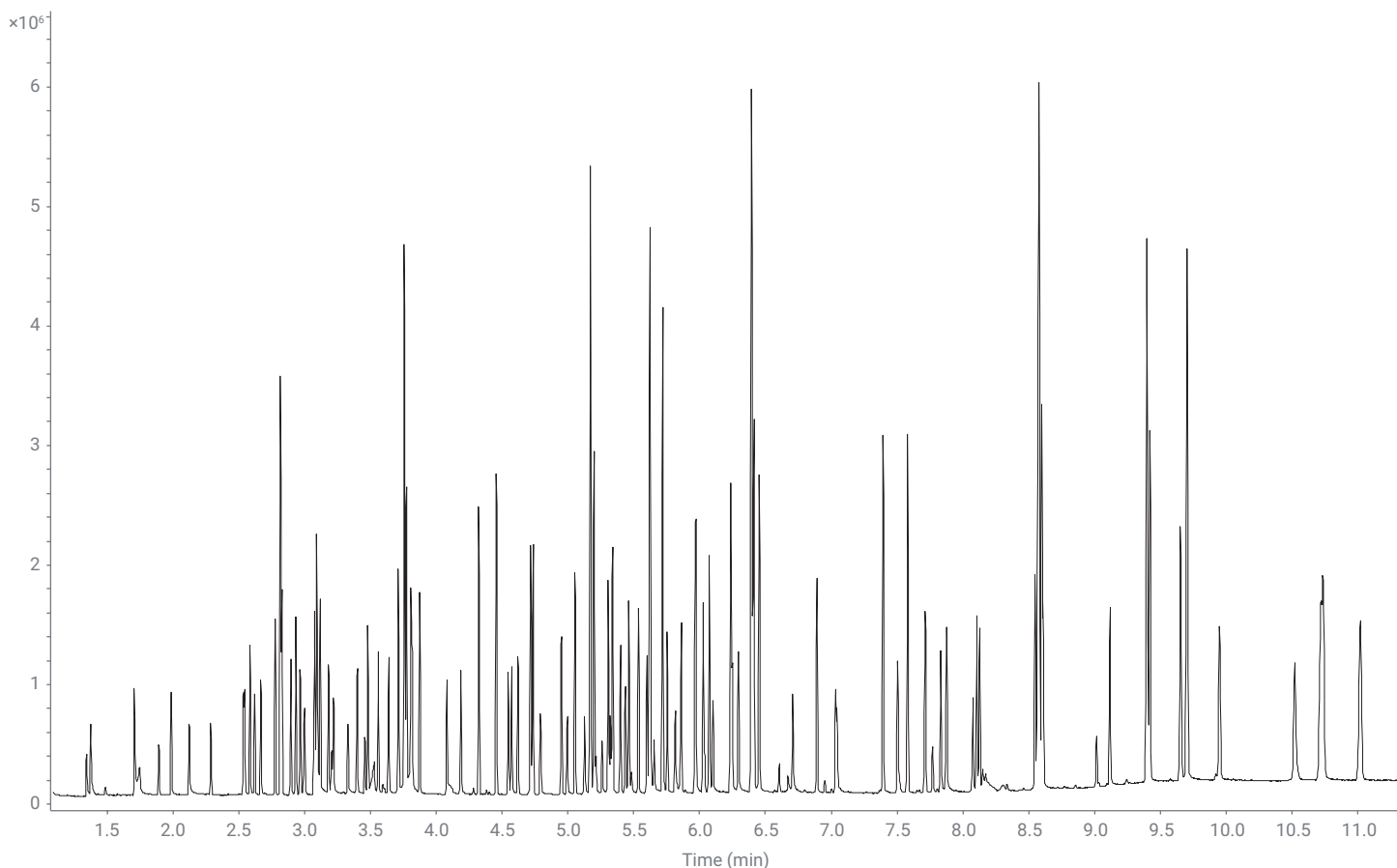

Figure 3. TIC of the 20 µg/mL calibration standard containing 119 target analytes and surrogates and six internal standards using H₂ carrier gas and the Agilent HydroInert source.

Critical pair resolution

With the shorter method time and a different column, critical pair resolution above 50% was verified for phenanthrene and anthracene (EIC 178 *m/z*), benz[a]anthracene and chrysene (EIC 228 *m/z*), and benzo(b)fluoranthene and benzo(k)fluoranthene (EIC 252 *m/z*). All three isomer pairs are

shown in Figure 4 at a midlevel concentration of 5 µg/mL; phenanthrene and anthracene (Figure 4A) have baseline resolution, benz[a]anthracene and chrysene (Figure 4B) are nearly baseline-resolved, and benzo(b)fluoranthene and benzo(k)fluoranthene (Figure 4C) are over 50% resolved, satisfying the EPA method 8270 criteria.

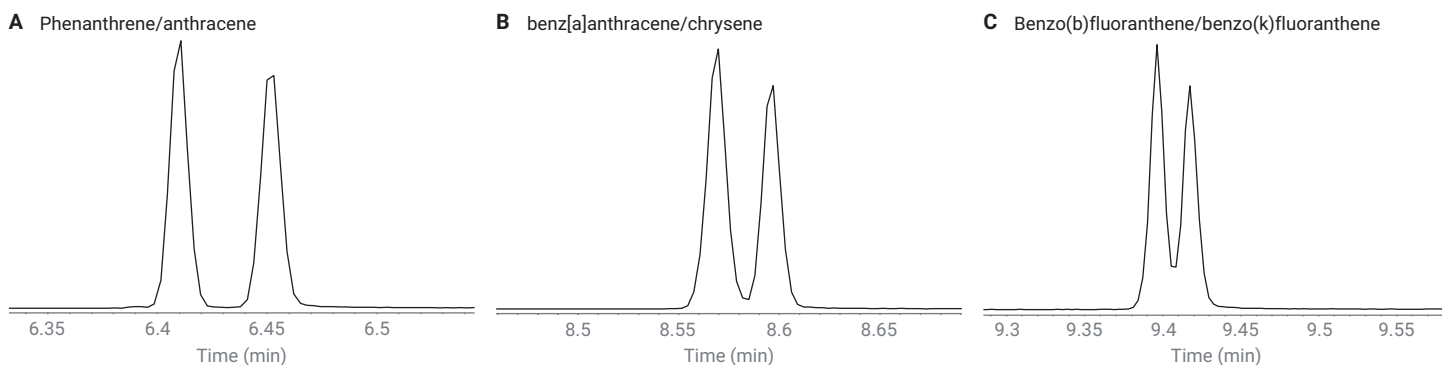

Figure 4. Midlevel standard (5 µg/mL) EICs for critical isomer pairs: (A) phenanthrene and anthracene (EIC 178 *m/z*); (B) benz[a]anthracene and chrysene (EIC 228 *m/z*); (C) benzo(b)fluoranthene and benzo(k)fluoranthene (EIC 252 *m/z*).

Response factor comparison between hydrogen and helium carrier gases

When moving an analysis from He to H₂ carrier gas, there is always concern about maintenance of response factors (RFs) and sensitivity for single quadrupole systems. Table 5 lists the RFs from EPA method 8270E guidance criteria (Table 4); RFs from a GC/MS analysis with He carrier gas when using a splitless injection, then a pulsed split injection, and RFs for GC/MS analysis with the HydroInert source and H₂ carrier gas. Since the H₂ method uses a split injection, the pulsed split injection with He provides a good comparison, while the splitless He data is the traditional analysis. The RFs from EPA method 8270E (Table 4) are guidance criteria and not requirements to pass the method, but ideally the RFs should be like these guidance values. For the He (splitless injection) GC/MS analysis, two compounds have RFs below the guidance criteria: hexachloroethane and N-nitroso-di-*n*-propylamine; these compounds' RFs are also low for the H₂ HydroInert results. For the H₂ HydroInert GC/MS analysis, five additional compounds have RFs below the guidance criteria, where four are within 0.1 points. For example, the guidance RF criteria for bis(2-chloroethyl)ether is 0.7 and the H₂ HydroInert GC/MS RF was 0.6. For the pulsed split He GC/MS results, all reported RFs match or are higher than the guidance from the EPA, but this data set did not report RFs for the seven indicated compounds in Table 5. In total, only seven compounds of the 72 listed in Table 5 had RFs lower than the EPA guidance for the H₂ HydroInert GC/MS results; five of these were within 0.1 points of the guidance RF value, and the other two RF values were within 0.3 or fewer points of the guidance.

Table 5. RFs for select compounds from EPA method 8270E (Table 4 in the EPA method)², GC/MS single quadrupole analysis with He carrier gas³, GC/MS single quadrupole analysis with He and pulsed split injection⁴, and GC/MS single quadrupole analysis with the Agilent HydroInert source and H₂ carrier gas.

Compound	Response Factors			
	From EPA 8270E	He GC/MS ³	He GC/MS, Pulsed Split ⁴	H ₂ HydroInert GC/MS
Acenaphthene	0.9	1.3	1.1	1.1
Acenaphthylene	0.9	1.9	2.0	1.4
Acetophenone	0.01	1.2	--	0.4
Anthracene	0.7	1.1	1.1	1.0
Benzo(a)anthracene	0.8	1.4	1.3	1.5
Benzo(a)pyrene	0.7	1.2	1.0	0.9
Benzo(b)fluoranthene	0.7	1.4	1.0	1.2
Benzo(g,h,i)perylene	0.5	1.1	1.1	1.0
Benzo(k)fluoranthene	0.7	1.2	1.1	1.2
Bis(2-chloroethoxy)methane	0.3	0.4	0.4	0.3
Bis(2-chloroethyl)ether	0.7	0.8	1.1	0.6
Bis-(2-ethylhexyl)phthalate	0.01	0.8	0.5	0.5
4-Bromophenyl-phenyl ether	0.1	0.3	0.2	0.2
Butyl benzyl phthalate	0.01	0.6	0.5	0.3
4-Chloroaniline	0.01	0.4	0.4	0.4
4-Chloro-3-methylphenol	0.2	0.3	0.2	0.2
2-Chloronaphthalene	0.8	2.4	1.2	1.0
2-Chlorophenol	0.8	0.8	1.2	0.7
4-Chlorophenyl-phenyl ether	0.4	0.7	0.6	0.5
Chrysene	0.7	1.2	1.2	1.1
Dibenz(a,h)anthracene	0.4	1.1	1.0	1.0
Dibenzofuran	0.8	1.7	1.7	1.5
Di- <i>n</i> -butyl phthalate	0.01	1.3	1.2	0.8
3,3'-Dichlorobenzidine	0.01	0.5	--	0.4
2,4-Dichlorophenol	0.2	0.3	0.3	0.2
Diethyl phthalate	0.01	1.4	1.3	1.0
Dimethyl phthalate	0.01	1.4	1.3	1.0
2,4-Dimethylphenol	0.2	0.3	0.3	0.3
4,6-Dinitro-2-methylphenol	0.01	0.2	--	0.1
2,4-Dinitrophenol	0.01	0.2	--	0.1
2,4-Dinitrotoluene	0.2	0.4	0.3	0.2
2,6-Dinitrotoluene	0.2	0.3	0.3	0.2
Di- <i>n</i> -octyl phthalate	0.01	1.3	1.4	0.8
Fluoranthene	0.6	1.2	1.2	1.2
Fluorene	0.9	1.3	1.3	1.2
Hexachlorobenzene	0.1	0.3	0.3	0.3
Hexachlorobutadiene	0.01	0.2	0.2	0.2
Hexachlorocyclopentadiene	0.05	0.3	0.4	0.1
Hexachloroethane	0.3	0.2	0.5	0.1
Indeno(1,2,3-cd)pyrene	0.5	1.2	1.0	1.2
Isophorone	0.4	0.6	0.5	0.4

Compound	Response Factors			
	From EPA 8270E	He GC/MS ³	He GC/MS, Pulsed Split ⁴	H ₂ Hydrolnert GC/MS
2-Methylnaphthalene	0.4	0.7	0.7	0.7
2-Methylphenol	0.7	0.7	1.0	0.6
4-Methylphenol	0.6	1.0	1.1	0.3
Naphthalene	0.7	1.1	1.0	1.0
2-Nitroaniline	0.01	0.4	0.3	0.2
3-Nitroaniline	0.01	0.3	0.3	0.2
4-Nitroaniline	0.01	0.3	0.3	0.2
Nitrobenzene	0.2	0.3	0.3	0.2
2-Nitrophenol	0.1	0.2	0.2	0.1
4-Nitrophenol	0.01	0.2	--	0.1
N-Nitroso-di-n-propylamine	0.5	0.4	0.7	0.4
N-Nitrosodiphenylamine	0.01	2.1	0.6	0.9
2,2'-Oxybis-(1-chloropropane)	0.01	0.5	1.1	0.5
Pentachlorophenol	0.05	0.2	--	0.1
Phenanthrene	0.7	1.2	1.1	1.1
Phenol	0.8	0.9	1.4	0.7
Pyrene	0.6	1.3	1.3	1.2
1,2,4,5-Tetrachlorobenzene	0.01	0.4	--	0.3
2,3,4,6-Tetrachlorophenol	0.01	0.4	0.3	0.2
2,4,5-Trichlorophenol	0.2	0.3	0.4	0.3
2,4,6-Trichlorophenol	0.2	0.3	0.4	0.2

Calibration results

A multipoint calibration was performed with the maximum of 13 concentration levels and the relative RF was determined for each compound and calibration level. The mean RF was calculated to build the calibration curve of each compound along with the relative standard deviation (RSD). The average RF %RSD must be <20%, which is the preferred passing criteria; if not achievable with at least six calibration levels, an R² value >0.990 is required for a linear curve fit, or a quadratic fit may be used. Accuracy for the lowest data point must be within 30% of estimated concentration with a minimum of six points for the curve fit. Results for the initial calibration using H₂ carrier gas and the Hydrolnert source can be found in Table 6.

Of 119 compounds, 14 compounds required linear fits and one quadratic fit was required. Table 6 summarizes the calibration results for the 119 target compounds and surrogates with average RF %RSD values, and the lowest and highest concentration level if the values are different from the full calibration range (0.1 to 100 µg/mL). Over 87% of the compounds pass the calibration criteria with an average RF %RSD below 20%. An increase in the number of compounds requiring linear fits is predictable since H₂ is more reactive than He and the inlet is set to a lower temperature to avoid formation of hydrochloric acid in the presence of higher temperatures and water in the inlet. Use of a multimode inlet may result in improved heavy phthalate and PAH results.

Sensitivity loss with H₂ carrier gas and existing mass spectrometer systems has been well reported. Due to this concern, particular attention was paid to the calibration range and verifying that most compounds were able to achieve the same calibration range as previous He analyses. On the topic of sensitivity, 96 compounds were analyzed in a previous application for EPA method 8270 with He carrier gas on GC/MS.³ Comparing these compounds with the same set using the Hydrolnert source and H₂ carrier gas (also GC/MS), 15 compounds have a narrower calibration range, where six compounds are only narrower by one concentration level starting at 200 ng/mL instead of 100 ng/mL, and four compounds start at 500 ng/mL. For benzoic acid, the Hydrolnert source with H₂ carrier as has the same calibration range of 0.8 to 100 µg/mL, as observed with He carrier gas on a GC/MS; 2,4-dinitrophenol passed calibration criteria with average RF for the range of 0.5 to 100 µg/mL with H₂ and the Hydrolnert source, while helium-collected data required a linear fit for the same calibration range. Pentachlorophenol also had matched calibration ranges between the He and H₂ results of 0.5 to 100 µg/mL, but the H₂ data required a linear fit. On the positive side, some compounds had wider calibration ranges with H₂ and the Hydrolnert source, such as 4-nitrophenol and 2-methyl-4,6-dinitrophenol, which each included an extra calibration level of 100 and 200 ng/mL, respectively. Also, these two compounds did not require linear curve fits, but passed calibration criteria with average RF %RSD values of 18.7% for 4-nitrophenol and 19.7% for 2-methyl-4,6 dinitrophenol. In total, 24 compounds out of 119 had narrower calibration ranges than the default of 0.1 to 100 µg/mL. The use of H₂ carrier gas with the Hydrolnert source retains the sensitivity range for over 84% of the previously tested 96 SVOCs.

Table 6. Initial calibration results for 119 target compounds and surrogates for H₂ carrier gas and the Agilent HydroInert source for EPA method 8270.

Name	Retention Time (min)	Average RF	Average RF %RSD	Curve Fit R ²	Curve Fit	Low Standard (µg/mL)	High Standard (µg/mL)
						Default is 0.1 to 100 µg/mL	
N-Nitrosodimethylamine	1.339	0.273	7.41				
Pyridine	1.372	0.459	15.39			0.5	
2-Picoline	1.705	0.561	5.89				
N-Nitroso-N-methylethylamine	1.741	0.232	7.23				
Methyl methanesulfonate	1.890	0.256	15.04				
2-Fluorophenol	1.983	0.568	5.20				
N-Nitroso-N-diethylamine	2.120	0.258	7.13				
Ethyl methanesulfonate	2.286	0.374	13.02				
Phenol-d ₆	2.532	0.667	4.93				
Phenol	2.541	0.664	6.32				
Aniline	2.583	0.968	7.50				
Bis(2-chloroethyl) ether	2.617	0.616	10.72				
2-Chlorophenol	2.665	0.661	8.50				
1,3-Dichlorobenzene	2.774	0.773	6.96				
1,4-Dichlorobenzene	2.825	0.804	7.53				
Benzyl alcohol	2.892	0.442	12.90				
1,2-Dichlorobenzene	2.931	0.756	7.53				
2-Methylphenol (o-cresol)	2.965	0.559	9.73				
Bis(2-chloro-1-methylethyl) ether	2.998	0.545	11.21				
1-Nitrosopyrrolidine	3.068	0.260	6.02				
p-Cresol	3.074	0.333	7.00				
N-Nitrosodi-n-propylamine	3.089	0.370	12.94				
Acetophenone	3.092	0.445	6.48				
4-Nitrosomorpholine	3.095	0.107	8.43				
o-Toluidine	3.116	0.487	8.39				
Hexachloroethane	3.180	0.112	8.62				
Nitrobenzene-d ₅	3.201	0.097	10.05				
Nitrobenzene	3.216	0.197	6.59				
Nitrosopiperidine	3.325	0.132	8.87				
Isophorone	3.395	0.433	7.86				
2-Nitrophenol	3.455	0.112	11.43				
2,4-Dimethylphenol	3.480	0.295	6.34				
Benzoic acid	3.519	0.117		0.9946	Linear	0.8	
Bis(2-chloroethoxy)methane	3.558	0.345	8.69				
2,4-Dichlorophenol	3.637	0.243	13.22				
1,2,4-Trichlorobenzene	3.710	0.356	10.34				
Naphthalene	3.773	0.978	8.27				
a,a-Dimethylphenethylamine	3.782	0.360		0.9976	Linear	0.2	
4-Chloroaniline	3.807	0.401	8.01				
2,6-Dichlorophenol	3.816	0.232	16.62				
Hexachlorobutadiene	3.873	0.177	19.36				

Name	Retention Time (min)	Average RF	Average RF %RSD	Curve Fit R ²	Curve Fit	Low Standard (µg/mL)	High Standard (µg/mL)
						Default is 0.1 to 100 µg/mL	
N-Nitrosobutylamine	4.079	0.172	9.34			0.2	
4-Chloro-3-methylphenol	4.185	0.204	10.56				
2-Methylnaphthalene	4.321	0.656	6.20				
Hexachlorocyclopentadiene	4.455	0.136		0.9928	Linear		
1,2,4,5-Tetrachlorobenzene	4.458	0.308	19.22				
2,4,6-Trichlorophenol	4.545	0.241	13.05				
2,4,5-Trichlorophenol	4.570	0.288	13.13				
2-Fluorobiphenyl	4.618	0.613	9.30				
1-Chloronaphthalene	4.715	1.018	9.32				
2-Chloronaphthalene	4.733	1.003	9.15				
2-Nitroaniline	4.791	0.226	14.72				
Dimethyl phthalate	4.948	1.005	10.34				
2,6-Dinitrotoluene	4.994	0.153	17.84			0.2	
Acenaphthylene	5.051	1.362	9.04				
m-Nitroaniline	5.124	0.178	10.30				
Acenaphthene	5.196	1.083	9.75				
2,4-Dinitrophenol	5.212	0.074	15.34			0.5	
4-Nitrophenol	5.260	0.143	18.74				
Pentachlorobenzene	5.305	0.428	14.62				
2,4-Dinitrotoluene	5.321	0.200	16.37				75
Dibenzofuran	5.339	1.486	9.57				
1-Naphthylamine	5.396	0.655	19.57				
2,3,4,6-Tetrachlorophenol	5.436	0.177		0.9912	Linear	0.5	
2-Naphthylamine	5.463	0.908	8.77				
Diethyl Phthalate	5.536	0.978	12.37			0.2	
Thionazin	5.599	0.142	16.65				
Fluorene	5.620	1.242	9.88				
5-Nitro-o-toluidine	5.623	0.209	19.75				
4-Chlorophenyl phenyl ether	5.623	0.530	15.50				
4-Nitroaniline	5.626	0.206		0.9943	Linear	0.2	
2-Methyl, 4,6-dinitrophenol	5.654	0.098	19.68			0.2	
Diphenylamine	5.717	0.943	9.95				
Azobenzene	5.754	0.397	5.84				
2,4,6-Tribromophenol	5.814	0.083	19.91				
Sulfotep	5.863	0.082		0.9976	Quadratic	0.2	
Diallate I	5.963	0.144	7.38				
Phorate	5.969	0.210	11.43				
Phenacetin	5.972	0.224	12.11				
4-Bromophenyl phenyl ether	6.026	0.197	8.23				
Diallate II	6.038	0.050	10.31				
Hexachlorobenzene	6.072	0.245	16.95				
Dimethoate	6.099	0.141	16.58				
4-Aminobiphenyl	6.235	0.611	10.94				

Name	Retention Time (min)	Average RF	Average RF %RSD	Curve Fit R ²	Curve Fit	Low Standard (µg/mL)	High Standard (µg/mL)
						Default is 0.1 to 100 µg/mL	
Pentachlorophenol	6.235	0.101		0.9911	Linear	0.5	
Pentachloronitrobenzene	6.247	0.054	19.27			0.5	
Propylamide	6.293	0.204	14.45				
Dinoseb	6.390	0.089	19.44				
Disulfoton	6.402	0.317		0.9966	Linear	0.5	
Phenanthrene	6.411	1.091	14.31				
Anthracene	6.453	1.009	11.90				
Methyl parathion	6.708	0.124	10.22				
Dibutyl phthalate	6.889	0.840	16.44				
Parathion	7.032	0.089	12.62				
4-Nitroquinoline-1-oxide	7.044	0.064	19.82				
Fluoranthene	7.395	1.188	8.54				
Benzidine	7.504	0.544	9.47				
Pyrene	7.580	1.207	8.59				
Aramite	7.710	0.044	18.03			0.2	
<i>p</i> -Terphenyl-d ₁₄	7.716	0.422	14.16				
Aramite II	7.770	0.044	12.41			0.2	
<i>p</i> -(Dimethylamino)azobenzene	7.834	0.195		0.9919	Linear	0.5	
Chlorobenzilate	7.876	0.294	10.53				
3,3'-Dimethylbenzidine	8.107	0.466	17.39				
Benzyl butyl phthalate	8.128	0.343		0.9926	Linear	0.5	
3,3'-Dichlorobenzidine	8.549	0.364		0.9939	Linear	0.5	
Benz[a]anthracene	8.570	1.443		0.9985	Linear	0.2	
Chrysene	8.600	1.047	11.58				
Bis(2-ethylhexyl) phthalate	8.612	0.502	17.43				
Di- <i>n</i> -octyl phthalate	9.118	0.832	16.61				
7,12-Dimethylbenz[a]anthracene	9.397	0.376		0.9947	Linear	0.8	
Benzo[b]fluoranthene	9.400	1.198	17.62				
Benzo[k]fluoranthene	9.421	1.170	16.60				
Benzo[a]pyrene	9.657	0.874	17.50				
3-Methylcholanthrene	9.954	0.328		0.9905	Linear	0.8	
Dibenz[a,j]acridine	10.523	0.594		0.9908	Linear	0.8	
Indeno(1,2,3-cd)pyrene	10.720	1.210	19.76				
Dibenz[a,h]anthracene	10.738	1.016	19.11				
Benzo[ghi]perylene	11.020	1.024	17.29				

As an example of full calibration range retention, Figure 5 compares the linear range for nitrobenzene in He carrier gas (Figure 5A), and in H₂ carrier gas with the HydroInert source (Figure 5B). The average RF %RSDs are remarkably similar between the results for He carrier gas and H₂ carrier gas with the HydroInert source, at 6.33% RSD for He carrier gas, and 6.59% RSD for H₂ carrier gas and the HydroInert source. The qualifiers and raw spectrum for nitrobenzene in this data set can be reviewed to verify consistent mass spectra and ion fragment ratios for the HydroInert source with H₂ carrier gas. Figure 6 shows (A) the nitrobenzene base peak EIC, (B) an overlay of the base peak and qualifier EICs, and (C) the raw

mass spectrum, at calibration level 8 (10 µg/mL). In Figure 6B, the qualifier EICs are scaled to match height, but the ratios between the qualifier ion and base peak are indicated in the upper left of the figure and the accuracy of the ratio to the quantitative method reference ratios. The reference ratio of 93 to 77 *m/z* for this quantitative method is 31; Figure 6B ratio of 93/77 was 35.1, which is within 20% of the expected ratio, and significant conversion of nitrobenzene to aniline was not observed. The retention of nitrobenzene and avoidance of hydrogenation is also shown in the raw spectrum of Figure 6C, where 93 *m/z* is not taller than 123 nor 77 *m/z*.

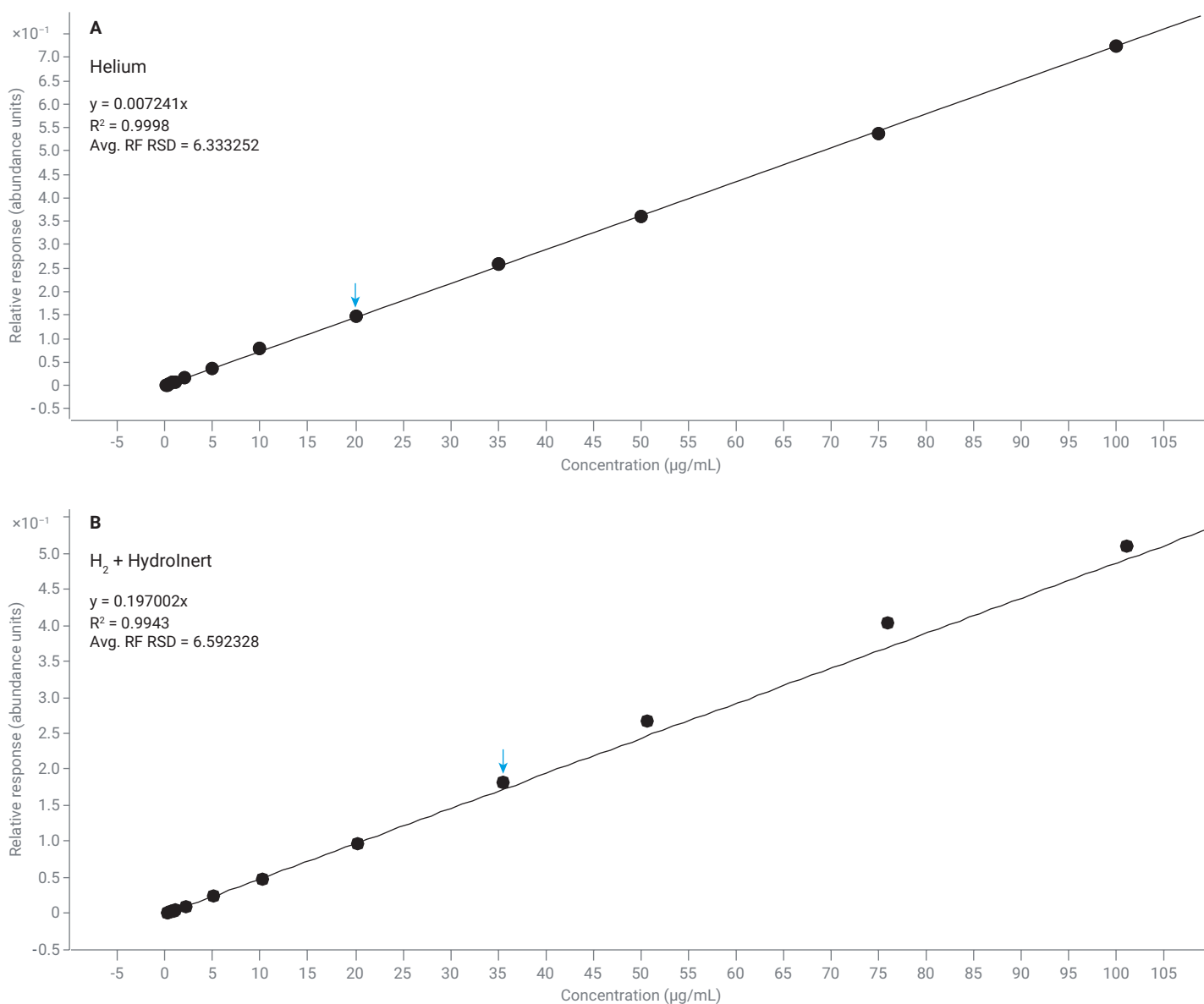

Figure 5. Nitrobenzene linear range (0.1 to 100 µg/mL) collected on a GC/MS system in (A) He and in (B) H₂ carrier gas with the Agilent HydroInert source.

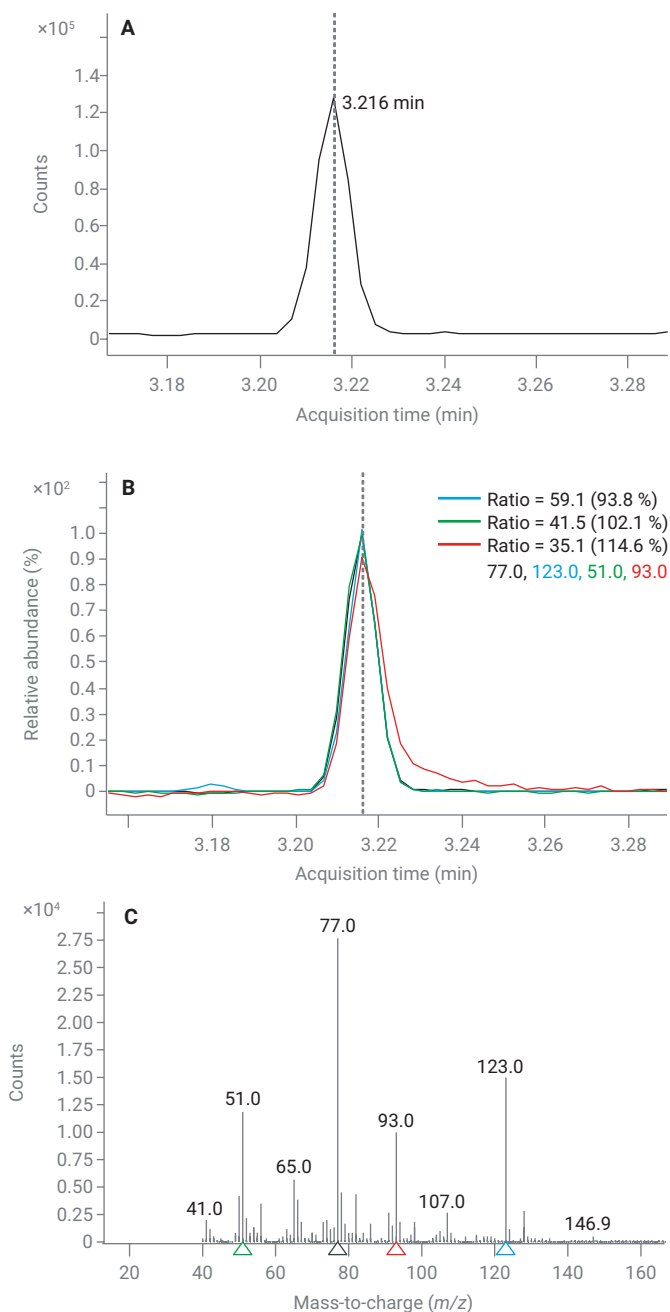

Figure 6. Nitrobenzene compound information for the 10 µg/mL standard; (A) extracted ion chromatogram (EIC 77 m/z) of the base peak; (B) overlay of base peak (77 m/z) and top three qualifier EICs (123, 51, 93 m/z); (C) raw mass spectrum for nitrobenzene peak at 3.216 minutes.

Repeatability in soil matrix

The large EPA method 8270 mixture of compounds was also diluted to a concentration of 15 µg/mL to act as a calibration verification standard, since 15 µg/mL was not a calibration point. To test the repeatability of the Hydrolnert source in GC/MS with H₂ carrier gas, the standard was sandwich injected with 1 µL of a composite soil matrix to simulate a spiked matrix sample. This injection was repeated nine times. Table 7 contains the following data for each compound: average calculated concentration of the nine replicates of 15 µg/mL calibration verification in soil matrix and the %RSD for the nine replicate injections in soil matrix. Looking at the average calculated concentration of the 15 µg/mL sample in matrix, only two compounds are identified outside of the ±20% range for a calibration verification, which are both reported as lower concentrations: 5-nitro-*o*-toluidine and dibutyl phthalate. The two compounds are within 25% of the 15 µg/mL spike value, and the matrix may be causing a small amount of signal suppression. The %RSD for the replicate injections in soil matrix are all below 7% RSD, indicating that the method is robust and consistent.

Table 7. Average concentration (nine replicate injections) of the 15 µg/mL calibration verification standard in soil matrix and the %RSD of the nine replicate injections.

Name	Average Calculated Concentration in Matrix of 15 µg/mL Spike	%RSD of Nine Replicates
N-Nitrosodimethylamine	15.6	2.21%
Pyridine	17.6	3.16%
2-Picoline	14.9	1.35%
N-Nitroso-N-methylethylamine	15.8	1.26%
Methyl methanesulfonate	15.0	2.05%
2-Fluorophenol	15.9	1.82%
N-Nitroso-N-diethylamine	15.6	2.53%
Ethyl methanesulfonate	15.0	2.14%
Phenol-d ₆	15.6	1.91%
Phenol	15.1	1.00%
Aniline	15.7	1.62%
Bis(2-chloroethyl) ether	15.0	1.49%
2-Chlorophenol	15.1	1.54%
1,3-Dichlorobenzene	15.0	1.11%
1,4-Dichlorobenzene	14.4	1.31%
Benzyl alcohol	15.2	2.39%
1,2-Dichlorobenzene	15.3	1.86%
2-Methylphenol (<i>o</i> -cresol)	15.6	1.43%
Bis(2-chloro-1-methylethyl) ether	14.4	1.91%
1-Nitrosopyrrolidine	14.9	2.73%
<i>p</i> -Cresol	14.2	1.08%
N-Nitrosodi- <i>n</i> -propylamine	14.6	2.71%
Acetophenone	14.7	2.35%

Name	Average Calculated Concentration in Matrix of 15 µg/mL Spike	%RSD of Nine Replicates
4-Nitrosomorpholine	14.4	2.40%
o-Toluidine	14.4	1.26%
Hexachloroethane	15.0	4.80%
Nitrobenzene-d ₅	15.0	1.53%
Nitrobenzene	14.8	1.87%
Nitrosopiperidine	14.5	2.32%
Isophorone	14.7	2.52%
2-Nitrophenol	15.4	3.43%
2,4-Dimethylphenol	14.3	1.79%
Benzoic acid	14.3	6.81%
Bis(2-chloroethoxy)methane	14.8	1.73%
2,4-Dichlorophenol	14.9	1.64%
1,2,4-Trichlorobenzene	15.0	1.31%
Naphthalene	14.4	1.50%
α,α-Dimethylphenethylamine	14.0	2.25%
4-Chloroaniline	15.5	1.80%
2,6-Dichlorophenol	17.9	1.34%
Hexachlorobutadiene	13.5	3.66%
N-Nitrosobutylamine	14.2	2.45%
4-Chloro-3-methylphenol	15.1	2.29%
2-Methylnaphthalene	14.7	1.59%
Hexachlorocyclopentadiene	12.6	3.44%
1,2,4,5-Tetrachlorobenzene	14.9	2.77%
2,4,6-Trichlorophenol	15.3	1.92%
2,4,5-Trichlorophenol	15.3	1.91%
2-Fluorobiphenyl	15.5	1.47%
1-Chloronaphthalene	14.9	1.65%
2-Chloronaphthalene	15.3	1.64%
2-Nitroaniline	15.4	1.75%
Dimethyl phthalate	15.8	1.42%
2,6-Dinitrotoluene	13.1	3.81%
Acenaphthylene	15.0	1.03%
m-Nitroaniline	12.4	2.93%
Acenaphthene	14.5	1.52%
2,4-Dinitrophenol	12.3	5.97%
4-Nitrophenol	12.8	2.57%
Pentachlorobenzene	16.2	1.84%
2,4-Dinitrotoluene	15.6	2.45%
Dibenzofuran	14.9	1.23%
1-Naphthylamine	14.1	1.28%
2,3,4,6-Tetrachlorophenol	12.7	3.86%
2-Naphthylamine	14.7	1.26%
Diethyl phthalate	14.4	2.21%
Thionazin	14.0	2.99%
Fluorene	14.2	1.72%
4-Chlorophenyl phenyl ether	14.4	2.41%
5-Nitro-o-toluidine	11.4	4.16%
4-Nitroaniline	14.9	3.37%

Name	Average Calculated Concentration in Matrix of 15 µg/mL Spike	%RSD of Nine Replicates
2-Methyl, 4,6-dinitrophenol	13.6	2.93%
Diphenylamine	15.2	0.66%
Azobenzene	14.8	2.76%
2,4,6-Tribromophenol	15.5	3.74%
Sulfotep	13.1	4.28%
Diallate I	15.6	3.38%
Phorate	14.9	2.14%
Phenacetin	16.1	2.66%
4-Bromophenyl phenyl ether	14.8	2.08%
Diallate II	14.9	3.70%
Hexachlorobenzene	16.9	2.73%
Dimethoate	12.7	2.42%
Pentachlorophenol	13.4	4.84%
4-Aminobiphenyl	16.0	2.40%
Pentachloronitrobenzene	16.7	6.40%
Propyzamide	15.2	2.86%
Dinoseb	13.0	3.24%
Disulfoton	14.2	4.39%
Phenanthrene	14.5	0.88%
Anthracene	15.0	2.01%
Methyl parathion	15.5	3.70%
Dibutyl phthalate	11.5	3.70%
Parathion	15.7	2.21%
4-Nitroquinoline-1-oxide	16.9	2.04%
Fluoranthene	15.0	0.95%
Benzidine	14.0	2.76%
Aramite	13.9	3.71%
Aramite II	13.3	3.59%
Pyrene	14.8	1.62%
p-Terphenyl-d ₁₄	15.3	1.98%
p-(Dimethylamino)azobenzene	14.0	2.05%
Chlorobenzilate	14.9	1.92%
3,3'-Dimethylbenzidine	14.6	2.11%
Benzyl butyl phthalate	13.8	2.51%
3,3'-Dichlorobenzidine	15.8	1.90%
Benz[a]anthracene	13.7	0.98%
Chrysene	14.5	1.31%
Bis(2-ethylhexyl) phthalate	15.2	1.89%
Di-n-octyl phthalate	14.3	1.30%
7,12-Dimethylbenz[a]anthracene	12.2	1.40%
Benzo[b]fluoranthene	14.7	1.50%
Benzo[k]fluoranthene	15.4	2.94%
Benzo[a]pyrene	15.4	2.07%
3-Methylcholanthrene	14.6	2.77%
Dibenz[a,j]acridine	13.0	1.58%
Indeno(1,2,3-cd)pyrene	15.8	1.44%
Dibenz[a,h]anthracene	15.5	2.18%
Benzo[ghi]perylene	15.5	1.56%

Conclusion

A method for testing SVOCs using H₂ carrier gas and the Agilent HydroInert source, which prevents hydrogenation and dechlorination of target analytes, has been developed for the Agilent 5977B Inert Plus GC/MSD. Method criteria for EPA method 8270D/E are met for the GC/MS tuning mixture, DFTPP tuning criteria, and initial calibration over the normal working range of 0.1 to 100 µg/mL in a single 12-minute run, with 15 compounds of the 119 tested compounds requiring curve fits. Retention of mass spectral fidelity is a breakthrough for the use of H₂ carrier gas with GC/MS systems, especially for environmental analyses, such as EPA method 8270.

References

1. Semivolatile Organic Compounds by Gas Chromatography/Mass Spectrometry (GC/MS); Method 8270D, *United States Environmental Protection Agency*, Revision 4, February **2007**.
2. Semivolatile Organic Compounds by Gas Chromatography/Mass Spectrometry (GC/MS); Method 8270E, *United States Environmental Protection Agency*, Revision 4, June **2018**.
3. Smith Henry, A. Analysis of Semivolatile Organic Compounds with Agilent Sintered Frit Liner by Gas Chromatography/Mass Spectrometry, *Agilent Technologies application note*, publication number 5994-0953EN, **2019**.
4. Ciotti, R. EPA 8270E with Pulsed Split Injection and Retention Time Locking on an 8890GC with a 5977 Series MSD, *Agilent Technologies application note*, publication number 5994-1500EN, **2020**.

www.agilent.com

DE83360322

This information is subject to change without notice.

© Agilent Technologies, Inc. 2022
Printed in the USA, June 23, 2022
5994-4890EN

Analysis of Semivolatile Organic Compounds with Hydrogen Carrier Gas and HydroInert Source by Gas Chromatography/Triple Quadrupole Mass Spectrometry (GC/MS/MS)

Author

Angela Smith Henry, PhD
Agilent Technologies, Inc.

Abstract

Gas chromatography/mass spectrometry (GC/MS) is integral to the analysis of semivolatile organic compounds (SVOCs) in environmental matrices. Some methods have extended instrumentation to include gas chromatography/triple quadrupole mass spectrometry (GC/MS/MS) as users push towards lower detection limits. Recent pressure on the helium (He) supply has required organizations to actively investigate hydrogen (H₂) carrier gas, but most GC/MS and GC/MS/MS analyses have reduced sensitivity and hydrogenation or dechlorination in the existing mass spectrometry products. New advances in mass spectrometer design have reduced hydrogenation and dechlorination reactions in the source. The Agilent HydroInert source retains the ability to analyze a wide calibration range, for some compounds from 0.02 to 100 µg/mL, and meet the U.S. Environmental Protection Agency (EPA) method 8270 calibration criteria when using H₂ carrier gas.

Introduction

GC/MS/MS has been determined to be suitable for use with the U.S. EPA method 8270 (version 8270E) in solid waste, soil, air, and water extracts.^{1,2} Previous application notes have discussed using He carrier gas with GC/MS/MS to extend the calibration range of EPA method 8270 down to 0.02 µg/mL, while retaining the top range of the method at 160 µg/mL.³

The availability of He has been a concern for several years, but interest in transitioning to alternative carrier gases has significantly increased in recent years. However, existing mass spectrometry systems have issues with hydrogenation of some functional groups, such as nitro groups, or dechlorination of heavily chlorinated compounds. These issues would alter the mass spectrum of a peak and lead to potential misidentification of compounds, or no identification of compounds if the precursor or product ions are affected by reactions with H₂ in a source. One example is with nitrobenzene, where H₂ carrier gas and nitrobenzene exposed to metal and heat, such as in a mass spectrometer source, will hydrogenate nitrobenzene (molecular weight (MW) 123 *m/z*) to aniline (MW 93 *m/z*). This is observed by the identification of aniline at the retention time of nitrobenzene and increase in 93 *m/z* fragment intensity compared to 123 *m/z*. A newly designed extractor source called the HydroInert source, for Agilent 7000C/D/E Inert Plus triple quadrupole GC/MS systems, addresses these H₂-related issues and helps improve performance with H₂ carrier gas in GC/MS and GC/MS/MS applications, including SVOC analyses. The HydroInert source with H₂ carrier gas retains mass spectral fidelity and can allow users to continue to use existing He-based mass spectral libraries, quantitative methods, and multiple reaction monitoring transitions (MRMs).

This application note demonstrates the ability of the HydroInert source to allow the use of H₂ carrier gas, while retaining critical functional groups, such as nitro groups and halogens. Retention of mass spectral fidelity is a breakthrough for the use of H₂ carrier gas with GC/MS systems, especially for environmental analyses such as EPA method 8270. Additionally, a method for EPA 8270 has been developed that retains similar sensitivity of a He carrier gas analysis, which allows for most compounds to be calibrated between 0.02 to 100 µg/mL with less than 20% of compounds requiring linear or quadratic curve fits.

Experimental

A set of stock standards containing 120 target compounds and surrogates was selected to provide a representative mixture of acids, bases, and neutral compounds, as well as comprising various compound classes, from nitrophenols to PAHs. The nine stock standards of target analytes were at concentrations of 2,000 µg/mL; part numbers for these stock standards are as follows: SVM-160, SVM-121, SVM-122, SVM-123, SVM-124, SVM-125, SVM-126-1, SVM-127, and US-211. Pyridine was diluted from a pure standard to 1,000 µg/mL as a working standard. The surrogate standard (part number ISM-332) contained six compounds at 2,000 µg/mL, indicated in Table 1. An internal standard mixture of six deuterated PAHs was used for recovery and calibration. The stock standards were combined and diluted in dichloromethane to make a working standard at 200 µg/mL. The working standard was then diluted to form the following nominal concentrations for the targets and surrogates for calibration standards: 0.02, 0.05, 0.1, 0.2, 0.5, 0.8, 1, 2, 5, 10, 20, 35, 50, 75, and 100 µg/mL. Internal standards were added to each calibration standard at a concentration level of 40 µg/mL. Table 1 lists the compounds that were used in the study. The compound numbers in Table 1 were assigned based on retention order of the targets and surrogates, with the internal standards listed at the end of the table out of retention order.

The tuning standard (part number GCM-150), containing a mixture of benzidine, pentachlorophenol, 4,4'-dichlorodiphenyltrichloroethane (4,4'-DDT), and decafluorotriphenylphosphine (DFTPP) was diluted to a concentration of 25 µg/mL and used to verify GC flow path inertness.

A composite mixture of soils extracted with dichloromethane was prepared for EPA method 8270 analysis. The mixture is a representative matrix residue that is typically encountered in the lab and was procured from Pace Analytical (Mt. Juliet, TN).

Table 1. Target, surrogates, and internal standards.

No.	Compound	No.	Compound	No.	Compound
1	N-Nitrosodimethylamine (NDMA)	43	4-Chloro-3-methyl phenol	85	Pentachloronitrobenzene
2	Pyridine	44	2-Methylnaphthalene	86	4-Aminobiphenyl
3	2-Picoline	45	1,2,4,5-Tetrachlorobenzene	87	Propyzamide
4	N-Nitroso-N-methylethylamine	46	Hexachlorocyclopentadiene	88	Phenanthrene
5	Methyl methanesulfonate	47	2,4,6-Trichlorophenol	89	Dinoseb
6	2-Fluorophenol (surrogate)	48	2,4,5-Trichlorophenol	90	Disulfoton
7	N-Nitrosodiethylamine	49	2-Fluorobiphenyl (surrogate)	91	Anthracene
8	Ethyl methanesulfonate	50	1-Chloronaphthalene	92	Parathion-methyl
9	Phenol-d ₆ (surrogate)	51	2-Chloronaphthalene	93	Di- <i>n</i> -butyl phthalate
10	Phenol	52	2-Nitroaniline	94	4-Nitroquinoline-1-oxide
11	Aniline	53	Dimethyl phthalate	95	Parathion
12	Bis(2-chloroethyl)ether	54	Acenaphthylene	96	Fluoranthene
13	2-Chlorophenol	55	2,6-Dinitrotoluene	97	Benzidine
14	1,3-Dichlorobenzene	56	3-Nitroaniline	98	Pyrene
15	1,4-Dichlorobenzene	57	Acenaphthene	99	<i>p</i> -Terphenyl-d ₁₄ (surrogate)
16	Benzyl alcohol	58	2,4-Dinitrophenol	100	Aramite I
17	1,2-Dichlorobenzene	59	Pentachlorobenzene	101	Aramite II
18	2-Methylphenol (<i>o</i> -cresol)	60	4-Nitrophenol	102	4-Dimethylaminoazobenzene
19	Bis(2-Chloro-1-methylethyl)ether	61	Dibenzofuran	103	Chlorobenzilate
20	4-Methylphenol (<i>p</i> -cresol)	62	2,4-Dinitrotoluene	104	3,3'-Dimethyl benzidine
21	N-Nitrosopyrrolidine	63	1-Naphthylamine	105	Famphur
22	Acetophenone	64	2,3,4,6-Tetrachlorophenol	106	Butyl benzyl phthalate
23	4-Nitrosomorpholine	65	2-Naphthylamine	107	Benzo[a]anthracene
24	N-Nitrosodi- <i>n</i> -propylamine	66	Diethyl phthalate	108	3,3'-Dichlorobenzidine
25	<i>o</i> -Toluidine	67	Fluorene	109	Chrysene
26	Hexachloroethane	68	Thionazin	110	Bis(2-ethylhexyl) phthalate
27	Nitrobenzene-d ₅ (surrogate)	69	5-Nitro- <i>o</i> -toluidine	111	Di- <i>n</i> -octyl phthalate
28	Nitrobenzene	70	4-Chlorophenyl phenyl ether	112	Benzo[b]fluoranthene
29	N-Nitrosopiperidine	71	4-Nitroaniline	113	7,12-Dimethylbenz[a]anthracene
30	Isophorone	72	2-methyl-4,6-dinitrophenol (DNOC)	114	Benzo[k]fluoranthene
31	2-Nitrophenol	73	N-Nitrosodiphenylamine	115	Benzo[a]pyrene
32	2,4-Dimethylphenol (2,4-xlenol)	74	Diphenylamine	116	3-Methylcholanthrene
33	Benzoic acid	75	Azobenzene	117	Dibenz[a,j]acridine
34	Bis(2-Chloroethoxy)methane	76	2,4,6-Tribromophenol (surrogate)	118	Indeno[1,2,3-cd]pyrene
35	2,4-Dichlorophenol	77	Sulfotep	119	Dibenz[a,h]anthracene
36	1,2,4-Trichlorobenzene	78	Dimethoate	120	Benzo[g,h,i]perylene
37	Naphthalene	79	Diallate I	121	1,4-Dichlorobenzene-d ₄ (internal standard)
38	4-Chloroaniline	80	Phorate	122	Naphthalene-d ₈ (internal standard)
39	2,6-Dichlorophenol	81	Phenacetin	123	Acenaphthalene-d ₁₀ (internal standard)
40	Hexachlorobutadiene	82	4-Bromophenyl phenyl ether	124	Phenanthrene-d ₁₀ (internal standard)
41	<i>p</i> -Phenylenediamine	83	Hexachlorobenzene	125	Chrysene-d ₁₂ (internal standard)
42	N-Nitrosodi- <i>n</i> -butylamine	84	Pentachlorophenol	126	Perylene-d ₁₂ (internal standard)

Instrumental methods

The Agilent 8890B GC was configured with a multimode inlet (MMI) and an Agilent J&W DB-5ms Ultra Inert GC column (part number 121-5522UI) interfaced with an Agilent 7000E Inert Plus triple quadrupole GC/MS system and an Agilent HydroInert source. Table 2 summarizes the GC/MS instrumentation and consumables used in this study. The GC and MS/MS method parameters (Table 3) have been optimized to provide a 12-minute method, while retaining the required resolution for isomer pairs and following the EPA 8270 guidelines for method parameters. The mass spectrometer was operated in electron ionization mode and was autotuned with the etune algorithm. Check tunes were run periodically to verify that the ion ratios and mass positions of the tune calibrant, perfluorotributylamine (PFTBA), were within tolerances. The analytical method used an Agilent Ultra Inert low pressure drop inlet liner with the 20:1 split injection and an Agilent J&W DB-5ms Ultra Inert GC column, 20 m × 0.18 mm, 0.18 μm; this column choice is preferred with H₂ carrier gas to maintain reasonable inlet pressures, as well as requiring a split injection to avoid overloading the column. Additionally, the split injection is better for the GC/MS/MS, which is commonly used for trace analyses with target analyte concentrations below 1 μg/mL. The 20:1 split drops the 100 μg/mL highest standard down to 5 μg/mL on column. With the ramped temperature of the inlet, H₂ carrier gas, and dichloromethane solvent, it is critical to verify extracted samples do not contain water; extraction steps must include a step to remove residual water to reduce the risk of generating hydrochloric acid in the inlet and causing damage to the instrument and consumables. The acquisition method was retention time locked to the internal standard, acenaphthene-d₁₀, to maintain consistent retention times across column changes and different instruments, which is critical. The final oven temperature hold time was tested at 2 minutes and 2.7 minutes; benzo[g,h,i]perylene eluted at 10.13 minutes and the 2-minute final hold would result in a method run time of 11.3 minutes, if cycle time is a concern. No quench gas is used with H₂ carrier gas; disconnect the He tubing from the back of the electronic pressure control module. Data was collected using dynamic MRM (dMRM) for more efficient use of the GC/MS/MS analytical time.

MRM transitions from previous application notes and methods were leveraged for this work to reduce the development of MRM transitions, but collision energies were reoptimized using Agilent MassHunter Optimizer. Additionally, some compounds were not listed in previous work and MassHunter Optimizer was used to identify the best MRM transitions and collision energies for the following compounds: 2,6-dichlorophenol, N-nitrosomethylethylamine, and N-nitrosomorpholine. For the GC/MS tuning mixture runs, a scan mode acquisition method was used, as DFTPP, DDT, and the breakdown products of DDT were not in the MRM acquisition method.

Instrumentation

Table 2. GC and MSD instrumentation and consumables.

Parameter	Value
GC	Agilent 8890 GC system
MS	Agilent 7000E Inert Plus triple quadrupole GC/MS with the Agilent HydroInert source
Extraction Lens	9 mm HydroInert
Syringe	Agilent Blue Line autosampler syringe, 10 μL, PTFE-tip plunger (p/n G4513-80203)
Column	Agilent J&W DB-5ms Ultra Inert GC column, 20 m × 0.18 mm, 0.18 μm (p/n 121-5522UI)
Inlet Liner	Agilent Ultra Inert inlet liner, low pressure drop, glass wool (p/n 5190-2295)

Instrument conditions

Table 3. GC and MSD instrument conditions.

Parameter	Value
Injection Volume	1 μL
Multimode Inlet	Split 20:1 250 °C (hold 0.3 min) ramp 200 °C/min to 350 °C (hold for run length) Postrun: 350 °C/min with 100 mL/min split flow
Column Temperature Program	40 °C (hold 0 min), 30 °C/min to 320 °C (hold 2 to 2.7 min*) Post run: 320 °C hold for 2 min
Carrier Gas and Flow Rate	H ₂ at 1.2 mL/min**, constant flow
Transfer Line Temperature	320 °C
Ion Source Temperature	300 °C
Quadrupole Temperature	150 °C
Collision Gas and Flow Rate	Nitrogen, 1.5 mL/min
Quench Gas	No quench gas is used with H ₂ carrier gas
EMV Mode	Gain factor
Gain Factor	1 (optimized for each system)
Scan Type	dMRM

* Oven hold time set to 2 minutes would generate a run time of 11.3 minutes; benzo[g,h,i]perylene eluted at 10.13 minutes.

** RT locking may result in a different flow rate on different instruments.

Results and discussion

GC/MS tuning mix

Even though the GC/MS/MS system can be and was tuned with the manufacturer's recommended tune, which is the etune default for Agilent 7000 series triple quadrupole GC/MS systems, the DFTPP ion ratio criteria from Table 3 of EPA method 8270E were used to test the HydroInert source with H₂ carrier gas.^{1,2} Table 4 summarizes the relative abundances of the DFTPP ion ratios at 25 µg/mL, the method criteria, and if the measured relative abundances matched the criteria, where all measured relative abundances pass the 8270E ion ratio criteria.

There is always concern of inlet and column cleanliness for EPA method 8270 to work, no matter the carrier gas; DDT, pentachlorophenol, and benzidine are used to track inlet breakdown and column health. Increased DDT breakdown indicates a need for inlet maintenance, while increasing tailing factors of benzidine and pentachlorophenol inform the user to trim or change the column. With the introduction of H₂ carrier gas, users may be worried about increased reactions of active compounds such as DDT in the inlet; the recommendation is to lower the inlet temperature to 230 to 250 °C and use a temperature-programmable inlet, such as the MMI, to protect the active compounds, while still being able to increase the temperature to 320 or 350 °C and drive out the PAHs. In this note, we have used the MMI.

Reviewing the results of the GC/MS tuning mixture for DDT breakdown and compound tailing factors from a scan mode run, the DDT (%) breakdown was 1.4%, the pentachlorophenol tailing factor was 1.0, and the benzidine tailing factor was 1.4. All values are within the EPA method 8270 criteria of <20% DDT breakdown and tailing factors <2.0.

Initial calibration

Figure 1 displays a total ion chromatogram (TIC) for the separation of 120 target analytes and six internal standards. A multipoint calibration was performed with 15 concentration levels from 0.02 to 100 µg/mL, and the relative response factor (RF) was determined for each compound at each calibration level. The average RF was calculated for the calibration curve of each compound along with the relative standard deviation (%RSD). The preferred passing criteria for EPA method 8270 is an average RF %RSD less than 20%; if not attainable with six or more calibration levels, a linear curve fit requires an R² value of 0.990 or greater, as does a quadratic curve fit. Accuracy of the lowest data point must be within 30% of the estimated concentration.

Table 4. DFTPP ions, abundance criteria from EPA method 8270E², measured relative abundance and pass/fail of the relative abundance for the Agilent HydroInert source in a GC/MS/MS system with H₂ carrier gas.

Target Mass (m/z)	Ion Abundance Criteria	Measured Relative Abundance	Pass/Fail
68	<2% of 69 m/z	0 %	Pass
69	Present	36.4 %	Pass
70	<2% of 69 m/z	1.1 %	Pass
197	<2% of 198 m/z	0 %	Pass
198	Base peak or present	100 % (base peak)	Pass
199	5 to 9% of 198 m/z	7.0 %	Pass
365	>1% of Base peak	1.8 %	Pass
441	<150% of 443 m/z	51.8 %	Pass
442	Base peak or present	46.7% (base peak)	Pass
443	15 to 24% of 442 m/z	21.9 %	Pass

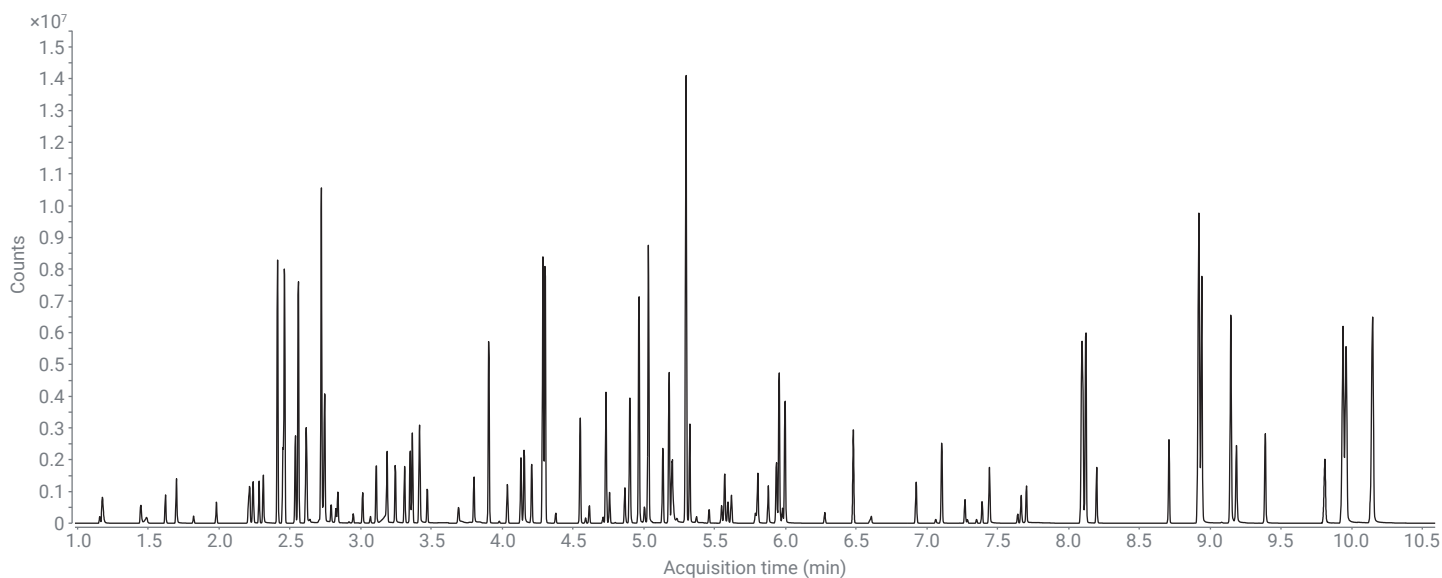

Figure 1. TIC of the 50 µg/mL calibration standard showing separation in under 10 minutes.

Critical pair resolution

With the shorter method time and different column, critical pair resolution above 50% was verified for phenanthrene and anthracene (MRM transition of 178.1 → 152.1 *m/z*), benz[a]anthracene and chrysene (228.1 → 226.1 *m/z*), and benzo(b)fluoranthene and benzo(k)fluoranthene (252.1 → 250.1 *m/z*). All three isomer pairs are shown in Figure 2 at a midlevel concentration of 5 µg/mL; phenanthrene and anthracene (Figure 2A) have baseline resolution, benz[a]anthracene and chrysene (Figure 2B) are nearly baseline resolved, and benzo(b)fluoranthene and benzo(k)fluoranthene (Figure 2C) are ~70% resolved, satisfying the EPA method 8270 criteria.

Mass spectral fidelity

A common concern of using H₂ carrier gas is the reactivity of H₂ at active sites, such as the hot metal inside of a source, which can cause hydrogenation and dechlorination reactions. Compound transformations, such as hydrogenation of nitro functional groups to amine groups could cause low or no response for MRM transitions that have been identified with He carrier gas and result in no identification or misidentification of a compound in a sample. Retention of existing method MRM transitions is preferred to reduce method development work. With the HydroInert source, users can retain the same MRM transitions with H₂ carrier

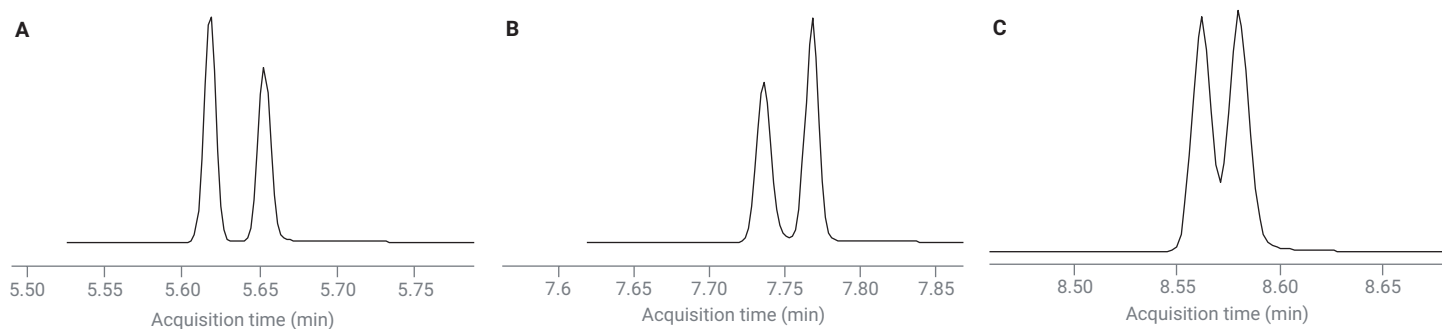

Figure 2. Midlevel standard (5 µg/mL) MRM transition extracted ion chromatograms (EICs) for critical isomer pairs: (A) phenanthrene and anthracene (MRM transition of 178.1 → 152.1 *m/z*); (B) benz[a]anthracene and chrysene (228.1 → 226.1 *m/z*); (C) benzo(b)fluoranthene and benzo(k)fluoranthene (252.1 → 250.1 *m/z*).

gas that they developed with He systems. Retention times and collision energies must be re-evaluated, especially for retention times if column dimensions and oven temperature ramps are altered. The compound list above has several nitro compounds and heavily chlorinated compounds that would be susceptible to reactions with H₂ in the normal extractor source, including nitrobenzene, pentachlorophenol, hexachlorobenzene, and pentachloronitrobenzene. We can observe retention of functional groups by verifying the MRM transition EICs exist and the expected ratios between the quantifier and qualifier MRM transitions. If the ratios for the qualifier transitions (compared to the quantifier transition) are close to 100%, reactions with H₂ are not occurring. Missing, very low, or very high MRM transition ratios would indicate reaction with H₂. Figure 3 shows a set of overlays of the MRM transitions for parathion (Figure 3A), a compound with a nitro group, and hexachlorobenzene (Figure 3B), a heavily chlorinated compound. Figures 3A and 3B each have the transition ratio percentages listed in the top-left corner. For parathion, if the nitro functional group was hydrogenated to an amine group, the 291 → 109 transition would be lower in abundance and ratio to the quantifier transition, as the MW would be 259 *m/z*, instead of 291 *m/z*. As shown in Figure 3A, the transition ratios were at 100%, indicating retention of the nitro functional group. For hexachlorobenzene, dechlorination would result in higher abundance of the 249 → 214 transition and lower abundance at 284 → 214 transition; however, Figure 3B displays retention of the expected ratio between these two transitions at 100%, and no significant dechlorination occurred.

Calibration data

Of 120 compounds, six compounds required linear fits and 10 quadratic fits were required. Table 5 summarizes the calibration results for the 120 target compounds and surrogates with average response factor (RF) %RSD values, the curve fit and R² value, if required, and the lowest and highest concentration level, if the values are different than the extended calibration range, 0.02 to 100 µg/mL. Over 86% of the 120 compounds pass the calibration criteria with an average RF %RSD below 20%. Of the 120 compounds, 13 compounds (<11%) had a calibration range narrower than the normal EPA method 8270 range of 0.1 to 100 µg/mL, but all still passed EPA method 8270E criteria by at least seven calibration levels or more. Looking at the previous work using EPA method 8270E and GC/MS/MS with He carrier gas, eight compounds required curve fits to pass the calibration criteria.³ An increase in linear and quadratic fits is predictable since H₂ is more reactive than He. Also, the inlet is initially set to a lower temperature to avoid formation of hydrochloric

acid in the presence of higher temperatures and water in the inlet, whether from carrier gas or the sample extraction procedure. In both He and the H₂ carrier gas results, bis(2-ethylhexyl)phthalate and di-*n*-octyl phthalate required quadratic fits to pass the calibration criteria. However, some of the compounds requiring curve fits were different between the two data sets. For example, N-nitrosodipropylamine passed with average RF %RSD of 12.3% for the He data, but required a linear fit for the H₂ carrier gas with the HydroInert source. N-nitrosodimethylamine (NDMA) required a linear fit from 0.2 to 100 µg/mL for the He-generated data, but passed

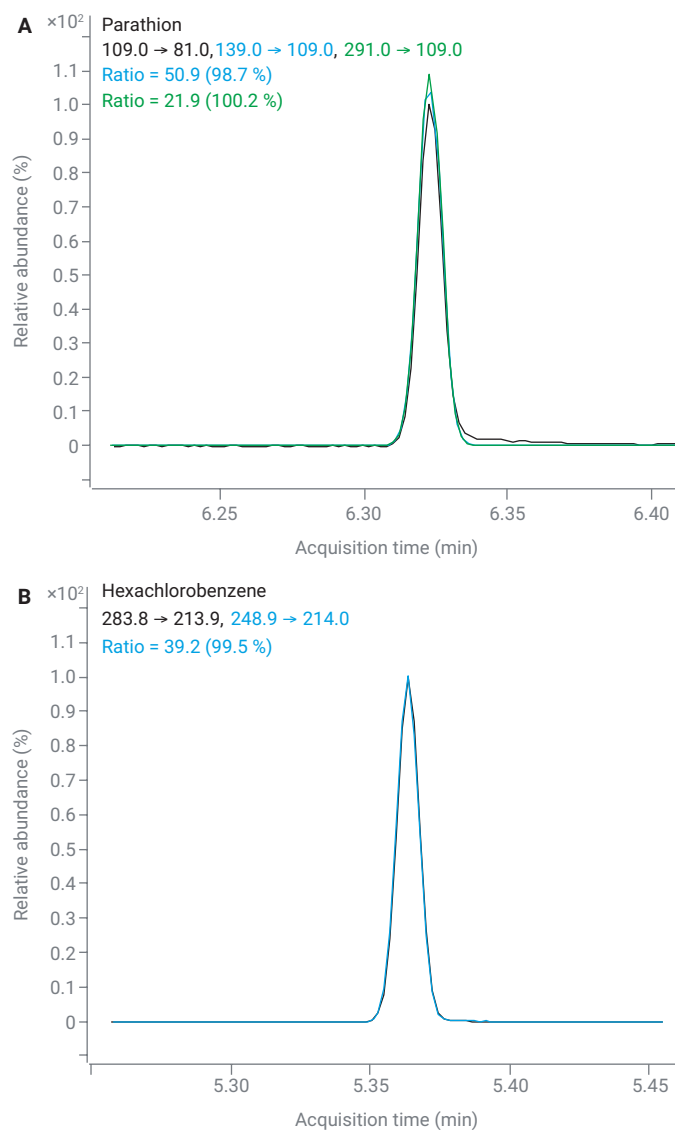

Figure 3. Overlays of MRM transition EICs for (A) parathion and (B) hexachlorobenzene, when using H₂ carrier gas and the Agilent HydroInert source on a GC/MS/MS system, showing retention of key functional groups in the presence of H₂.

Table 5. Initial calibration results for 120 target compounds and surrogates for H₂ carrier gas and the Agilent HydroInert source in GC/MS/MS for EPA method 8270.

Name	RT (min)	Avg. RF	Average RF %RSD	Curve Fit R ²	Curve Fit	Low Standard (µg/mL)	High Standard (µg/mL)
						Default is 0.02 to 100 µg/mL	
NDMA	1.1613	0.074	17.28			0.02	100
Pyridine	1.1832	0.487	16.17			0.05	100
2-Picoline	1.4508	0.154	11.23			0.05	100
N-Nitroso-N-methylethylamine	1.4893	0.101	13.58			0.02	100
Methyl methanesulfonate	1.6215	0.385	6.18			0.02	100
2-Fluorophenol (surrogate)	1.6962	0.515	12.02			0.02	100
N-Nitrosodiethylamine	1.8184	0.069	15.15			0.02	100
Ethyl methanesulfonate	1.9794	0.307	7.28			0.02	100
Phenol-d ₆ (surrogate)	2.2064	0.287	9.81			0.02	100
Phenol	2.2135	0.278	12.45			0.05	100
Aniline	2.2394	0.638	11.65			0.02	100
Bis(2-chloroethyl)ether	2.2817	0.538	4.95			0.02	100
2-Chlorophenol	2.3106	0.536	11.28			0.02	100
1,3-Dichlorobenzene	2.413	0.922	2.68			0.02	100
1,4-dichlorobenzidine-d ₄ (ISTD)	2.450		3.46			0.02	100
1,4-Dichlorobenzene	2.461	0.917	3.36			0.02	100
Benzyl alcohol	2.5379	0.388	14.57			0.02	100
1,2-Dichlorobenzene	2.5582	0.879	2.65			0.02	100
2-Methylphenol (o-cresol)	2.6123	0.524	7.24			0.02	100
Bis(2-chloro-1-methylethyl)ether	2.639	0.031	7.60			0.02	100
N-Nitrosopyrrolidine	2.7006	0.029	14.89			0.05	100
4-Methylphenol (p-cresol)	2.7173	0.738	8.05			0.02	100
Acetophenone	2.7202	0.971	7.46			0.05	100
N-Nitrosodi-n-propylamine	2.722	0.027		0.9951	Linear	0.1	100
4-Nitrosomorpholine	2.7331	0.097	16.61			0.02	100
o-Toluidine	2.741	0.735	9.62			0.02	100
Hexachloroethane	2.7897	0.150	6.42			0.02	100
Nitrobenzene-d ₅ (surrogate)	2.8228	0.074	11.46			0.02	100
Nitrobenzene	2.837	0.259	12.83			0.05	100
N-Nitrosopiperidine	2.9445	0.049	15.16			0.1	100
Isophorone	3.0114	0.251	9.29			0.02	100
2-Nitrophenol	3.0661	0.067	16.02			0.02	100
2,4-Dimethylphenol (2,4-xylenol)	3.107	0.441	7.45			0.02	100
Benzoic acid	3.1093	0.202		0.9965	Linear	2	100
bis(2-Chloroethoxy)methane	3.186	0.741	6.02			0.02	100
2,4-Dichlorophenol	3.2418	0.420	17.51			0.02	100
1,2,4-Trichlorobenzene	3.3073	0.577	7.97			0.02	100
Naphthalene-d ₈ (ISTD)	3.348		3.25			0.02	100
Naphthalene	3.3634	0.902	3.21			0.02	100
4-Chloroaniline	3.4127	0.558	5.69			0.02	100
2,6-Dichlorophenol	3.4162	0.353	15.57			0.02	100
Hexachlorobutadiene	3.4689	0.410	4.92			0.02	100

Name	RT (min)	Avg. RF	Average RF %RSD	Curve Fit R ²	Curve Fit	Low Standard (µg/mL)	High Standard (µg/mL)
						Default is 0.02 to 100 µg/mL	
<i>p</i> -Phenylenediamine	3.6874	0.232	11.54			0.1	100
N-Nitrosodi- <i>n</i> -butylamine	3.6903	0.069	8.48			0.02	100
4-Chloro-3-methylphenol	3.7999	0.372	11.05			0.02	100
2-Methylnaphthalene	3.9022	1.689	4.44			0.02	100
Hexachlorocyclopentadiene	4.0322	0.034	18.12			0.02	100
1,2,4,5-Tetrachlorobenzene	4.0348	0.230	6.13			0.02	100
2,4,6-Trichlorophenol	4.1305	0.171	19.08			0.02	100
2,4,5-Trichlorophenol	4.1537	0.255	15.58			0.02	100
2-Fluorobiphenyl (surrogate)	4.2061	0.364	3.16			0.02	100
1-Chloronaphthalene	4.2848	0.810	4.80			0.02	100
2-Chloronaphthalene	4.2998	0.784	4.74			0.02	100
2-Nitroaniline	4.3763	0.060	15.70			0.02	100
Dimethyl phthalate	4.5458	0.799	10.18			0.02	100
2,6-Dinitrotoluene	4.5829	0.034	9.97			0.02	100
Acenaphthylene	4.6136	0.146	7.06			0.02	100
3-Nitroaniline	4.7069	0.034	16.75			0.1	100
Acenaphthene-d ₁₀ (ISTD)	4.731		3.03			0.02	100
Acenaphthene	4.7548	0.184	2.87			0.02	100
2,4-Dinitrophenol	4.801	0.006		0.9988	Linear	1	100
Pentachlorobenzene	4.8623	0.149	4.46			0.02	100
4-Nitrophenol	4.8639	0.055	15.34			0.1	100
Dibenzofuran	4.8969	1.389	4.27			0.02	100
2,4-Dinitrotoluene	4.9036	0.030	17.05			0.1	100
1-Naphthylamine	4.9616	0.746	10.88			0.02	100
2,3,4,6-Tetrachlorophenol	5.0024	0.066	18.19			0.1	75
2-Naphthylamine	5.0276	0.906	7.70			0.02	100
Diethyl phthalate	5.1254	0.583	12.91			0.1	100
Fluorene	5.1741	1.433	4.42			0.02	100
Thionazin	5.1855	0.037		0.9992	Quadratic	0.05	100
5-Nitro- <i>o</i> -toluidine	5.1925	0.052	17.22			0.2	100
4-Chlorophenyl phenyl ether	5.1941	0.363	8.62			0.02	100
4-Nitroaniline	5.1986	0.111	15.16			0.1	100
2-Methyl-4,6-dinitrophenol (DNOC)	5.2271	0.009		0.9992	Linear	0.2	75
N-Nitrosodiphenylamine	5.2922	2.207	5.19			0.02	100
Diphenylamine	5.2923	2.697	5.23			0.02	100
Azobenzene	5.3216	0.966	19.48			0.1	100
2,4,6-Tribromophenol (surrogate)	5.3661	0.048	18.64			0.05	100
Sulfotep	5.4547	0.046		1.0000	Quadratic	0.1	100
Dimethoate	5.4556	0.004		0.9996	Quadratic	0.1	100
Diallate I	5.5446	0.056		0.9995	Quadratic	0.2	100
Phorate	5.5454	0.112	19.23			0.05	50
Phenacetin	5.5584	0.395		0.9926	Linear	0.2	100
4-Bromophenyl phenyl ether	5.591	0.214	4.60			0.02	100
Hexachlorobenzene	5.6139	0.411	3.63			0.02	100

Name	RT (min)	Avg. RF	Average RF %RSD	Curve Fit R ²	Curve Fit	Low Standard (µg/mL)	High Standard (µg/mL)
						Default is 0.02 to 100 µg/mL	
Pentachlorophenol	5.785	0.106		0.9996	Quadratic	0.5	100
Pentachloronitrobenzene	5.7933	0.053	17.34			0.02	100
4-Aminobiphenyl	5.8011	0.415	7.12			0.02	100
Propyzamide	5.8731	0.228	18.96			0.1	75
Phenanthrene-d ₁₀ (ISTD)	5.936		2.96			0.02	100
Phenanthrene	5.9516	1.117	6.24			0.02	100
Dinoseb	5.9596	0.046	16.84			0.2	100
Disulfoton	5.9761	0.189		0.9999	Quadratic	0.05	100
Anthracene	5.9921	0.857	3.53			0.02	100
Parathion-methyl	6.2746	0.068	18.32			0.02	100
Di- <i>n</i> -butyl phthalate	6.4745	0.567	19.97			0.05	100
4-Nitroquinoline-1-oxide	6.5908	0.011	19.12			0.2	75
Parathion	6.6037	0.032	16.40			0.05	100
Fluoranthene	6.9204	0.344	4.85			0.02	100
Benzidine	7.0591	0.029	17.04			0.1	100
Pyrene	7.1006	0.361	4.52			0.02	100
<i>p</i> -Terphenyl-d ₁₄ (surrogate)	7.2656	0.141	3.33			0.02	100
Aramite I	7.2822	0.014	12.68			0.02	100
Aramite II	7.3467	0.013	11.52			0.02	100
4-Dimethylaminoazobenzene	7.3855	0.053		0.9989	Quadratic	0.05	100
Chlorobenzilate	7.4376	0.171	19.35			0.02	75
Famphur	7.6348	0.061	11.33			0.02	50
3,3'-Dimethyl benzidine	7.6608	0.097	11.45			0.05	100
Butyl benzyl phthalate	7.6991	0.155		0.9986	Quadratic	0.05	100
Benz[a]anthracene	8.0875	1.018	9.47			0.05	100
3,3'-Dichlorobenzidine	8.0933	0.075	16.78			0.1	100
Chrysene-d ₁₂ (ISTD)	8.100		3.61			0.02	100
Chrysene	8.1151	0.437	6.10			0.02	100
bis(2-Ethylhexyl) phthalate	8.1936	0.250		0.9992	Quadratic	0.05	100
Di- <i>n</i> -octyl phthalate	8.7044	0.470		0.9991	Quadratic	0.05	100
Benzo[b]fluoranthene	8.9096	1.258	3.89			0.02	100
7,12-Dimethylbenz[a]anthracene	8.9135	0.603	14.52			0.02	100
Benzo[k]fluoranthene	8.9307	1.258	4.48			0.02	100
Benzo[a]pyrene	9.1396	0.922	11.99			0.02	100
Perylene-d ₁₂ (ISTD)	9.183		5.97			0.02	100
3-Methylcholanthrene	9.3835	0.455	19.13			0.02	100
Dibenz[a,j]acridine	9.7986	0.375		0.9923	Linear	0.2	100
Indeno[1,2,3-cd]pyrene	9.9277	0.961	12.31			0.02	100
Dibenz[a,h]anthracene	9.9494	0.140	10.41			0.02	100
Benzo[g,h,i]perylene	10.133	1.265	4.92			0.02	100

calibration criteria across the full default range of 0.02 to 100 µg/mL, with an average RF %RSD of 17.3% using the H₂ carrier gas with the Hydrolnert source.³ Individual differences in specific compounds are expected since the method was moved from an inert gas to a more reactive gas, and changes were made to the inlet and oven parameters.

During method development, the starting MMI temperature was varied to test for the best results across the entire run time. The best results were generated when the MMI was ramped up from 250 to 350 °C in this method. The inlet was also tested starting at a lower inlet temperature of 230 °C, which had better results for some of the earlier-eluting sensitive compounds, such as benzoic acid, but the later-eluting PAHs did not perform as well with respect to the linear ranges, and there was some risk of carryover. The specific inlet parameters should be optimized by the user for their analysis needs.

Sensitivity loss with H₂ carrier gas and existing mass spectrometer systems has been well reported. Due to this concern, particular attention was paid to the calibration range and verifying that most compounds were able to achieve the same calibration range as previous He analyses. On the topic of sensitivity, 77 compounds were analyzed in a previous application for EPA method 8270 with He carrier gas on GC/MS/MS.³ Comparing these compounds with the same set using the Hydrolnert source and H₂ carrier gas (also GC/MS/MS), only 8 more compounds required linear or quadratic fits than the He data. As is normal, benzoic acid required a linear fit with a calibration range of 2 to 100 µg/mL, where the curve fit and calibration range was the same between He and H₂ data. For 2,4-dinitrophenol, both analyses required linear fits but the H₂ data had a narrower range, starting at 1 µg/mL instead of 0.5 µg/mL

for He. When starting at 230 °C for the inlet temperature, the 2,4-dinitrophenol calibration range started at 0.5 µg/mL; if 2,4-dinitrophenol detection is most critical, then the method should be built for this sensitive compound. Pentachlorophenol had the same curve fit, quadratic, and a calibration range of 0.5 to 100 µg/mL for both H₂ with Hydrolnert source and He results. On the other hand, 4-nitrophenol passed calibration criteria with an average RF %RSD of 17.4% with a 0.1 to 100 µg/mL range for the H₂ analysis, while the He results required a linear fit from 5 to 160 µg/mL. Also, benzidine was routinely identifiable in all analyses with H₂ and Hydrolnert source in the GC/MS/MS; in this specific method, the average RF %RSD was 17.5% for the full extended calibration range from 0.02 to 100 µg/mL, while the benzidine data was not included in the He results. Another pair of examples of extended calibration range with the H₂ and Hydrolnert data can be shown with bis(2-ethylhexyl) phthalate and di-*n*-octylphthalate. Both phthalate compounds had a wider calibration range of 0.05 to 100 µg/mL with a quadratic fit for the H₂ data, compared to the He quadratic fit from 0.5 to 100 µg/mL. Reviewing the internal standards, the average RF %RSDs are all below 6%, indicating consistent performance for the H₂ carrier gas, Hydrolnert source, and GC/MS/MS, and no issues with hydrogenation of deuterated compounds. The deuterated surrogate compounds, nitrobenzene-d₅, phenol-d₆, and *p*-terphenyl-d₁₄, further support the retention of deuterium bonds with average RF %RSDs below 12% for the extended calibration curves. Of the 77 comparable compounds between the H₂ and He data, 80% (60 compounds) had similar or wider calibration ranges for H₂ and Hydrolnert results. H₂ carrier gas with the Hydrolnert source retains the sensitivity for most compounds when compared to the He data.

Response factor (RF) comparison

There is always concern about sensitivity and maintenance of response factors (RFs) for both single quadrupole and triple quadrupole systems when moving an analysis from He to H₂ carrier gas. Table 6 lists the RFs from EPA method 8270E guidance criteria (Table 4), RFs from a GC/MS analysis with He carrier gas, and RFs for GC/MS/MS analysis with the Hydrolnert source and H₂ carrier gas. All of these test systems used 9 mm extraction lenses, respective of the source type (e.g. the Hydrolnert source had a Hydrolnert 9 mm extraction lens). The RFs from EPA method 8270E Table 4 are guidance criteria and not requirements to pass the method, but ideally the RFs should be similar to these

guidance values. For the He GC/MS analysis, two compounds have RFs below the guidance criteria: hexachloroethane and N-nitroso-di-*n*-propylamine. For the H₂ Hydrolnert GC/MS/MS analysis, there were 14 more compounds with RF values lower than the guidance criteria than the He GC/MS system, but the GC/MS/MS also opens the potential to analyze lower concentration levels, down to 20 ng/mL, when the normal calibration range is 100 ng/mL to 100 µg/mL. Seven of these low RF compounds are within 0.2 counts of the suggested RF value. It is difficult to determine the significance of the difference, since the reference RF values are data generated on single quadrupole GC/MS systems using He carrier gas.

Repeatability in matrix

Table 6. RFs for select compounds (in alphabetical order) from EPA method 8270E (Table 4)⁴, GC/MS single quadrupole analysis with He carrier gas and GC/MS/MS triple quadrupole analysis with the Agilent Hydrolnert source and H₂ carrier gas.

Compound	RF from EPA 8270E ⁴	RF He GC/MS	RF H ₂ and Hydrolnert GC/MS/MS
Acenaphthene	0.9	1.3	0.2
Acenaphthylene	0.9	1.9	0.1
Acetophenone	0.01	1.2	1.0
Anthracene	0.7	1.1	0.9
Benzo(a)anthracene	0.8	1.4	1.0
Benzo(a)pyrene	0.7	1.2	1.0
Benzo(b)fluoranthene	0.7	1.4	1.2
Benzo(g,h,i)perylene	0.5	1.1	1.3
Benzo(k)fluoranthene	0.7	1.2	1.3
Bis(2-chloroethoxy)methane	0.3	0.4	0.7
Bis(2-chloroethyl)ether	0.7	0.8	0.5
Bis-(2-ethylhexyl)phthalate	0.01	0.8	0.2
4-Bromophenyl-phenyl ether	0.1	0.3	0.2
Butyl benzyl phthalate	0.01	0.6	0.1
4-Chloroaniline	0.01	0.4	0.6
4-Chloro-3-methylphenol	0.2	0.3	0.4
2-Chloronaphthalene	0.8	2.4	0.7
2-Chlorophenol	0.8	0.8	0.5
4-Chlorophenyl-phenyl ether	0.4	0.7	0.3
Chrysene	0.7	1.2	0.4
Dibenz(a,h)anthracene	0.4	1.1	0.2
Dibenzofuran	0.8	1.7	1.4
Di- <i>n</i> -butyl phthalate	0.01	1.3	0.5
3,3'-Dichlorobenzidine	0.01	0.5	0.1
2,4-Dichlorophenol	0.2	0.3	0.4
Diethyl phthalate	0.01	1.4	0.6
Dimethyl phthalate	0.01	1.4	0.8
2,4-Dimethylphenol	0.2	0.3	0.4
4,6-Dinitro-2-methylphenol	0.01	0.2	0.01
2,4-Dinitrophenol	0.01	0.2	0.01
2,4-Dinitrotoluene	0.2	0.4	0.02

Compound	RF from EPA 8270E ⁴	RF He GC/MS	RF H ₂ and Hydrolnert GC/MS/MS
2,6-Dinitrotoluene	0.2	0.3	0.03
Di- <i>n</i> -octyl phthalate	0.01	1.3	0.4
Fluoranthene	0.6	1.2	0.4
Fluorene	0.9	1.3	1.4
Hexachlorobenzene	0.1	0.3	0.4
Hexachlorobutadiene	0.01	0.2	0.4
Hexachlorocyclopentadiene	0.05	0.3	0.03
Hexachloroethane	0.3	0.2	0.1
Indeno(1,2,3-cd)pyrene	0.5	1.2	1.1
Isophorone	0.4	0.6	0.3
2-Methylnaphthalene	0.4	0.7	1.7
2-Methylphenol	0.7	0.7	0.6
4-Methylphenol	0.6	1.0	0.7
Naphthalene	0.7	1.1	0.9
2-Nitroaniline	0.01	0.4	0.05
3-Nitroaniline	0.01	0.3	0.02
4-Nitroaniline	0.01	0.3	0.1
Nitrobenzene	0.2	0.3	0.3
2-Nitrophenol	0.1	0.2	0.1
4-Nitrophenol	0.01	0.2	0.05
N-Nitroso-di- <i>n</i> -propylamine	0.5	0.4	0.03
N-Nitrosodiphenylamine	0.01	2.1	2.9
2,2'-Oxybis-(1-chloropropane)	0.01	0.5	0.03
Pentachlorophenol	0.05	0.2	0.1
Phenanthrene	0.7	1.2	1.1
Phenol	0.8	0.9	0.3
Pyrene	0.6	1.3	0.3
1,2,4,5-Tetrachlorobenzene	0.01	0.4	0.2
2,3,4,6-Tetrachlorophenol	0.01	0.4	0.07
2,4,5-Trichlorophenol	0.2	0.3	0.2
2,4,6-Trichlorophenol	0.2	0.3	0.2

The large EPA method 8270 mixture of compounds was also diluted to a concentration of 0.4 µg/mL to act as a calibration verification standard, since 0.4 µg/mL was not a specific calibration point. To test the repeatability of the HydroInert source in GC/MS/MS with H₂ carrier gas, the standard was sandwich-injected with 1 µL of a composite soil matrix to simulate a spiked matrix sample. This injection was repeated 10 times to understand the robustness of the method and to look for matrix enhancement, suppression, or potential contamination from the soil matrix. Table 7 contains the following data for each compound: calculated concentration of 0.4 µg/mL calibration verification in solvent, average concentration of the 10 replicates of 0.4 µg/mL calibration verification in soil matrix, the %RSD for the 10 replicate injections in soil matrix, and the recovery percentage comparing the soil matrix and solvent concentrations.

Compounds with calibration ranges that did not include 0.2 µg/mL or lower were not included in the table. For the 0.4 µg/mL solvent standard, only five compounds fell outside of the ±20% calibration verification window: sulfotep, dimethoate, diallate I, aramite I, and 7,12-dimethylbenz[a]anthracene. The first three compounds all were calibrated with quadratic fits and this verification concentration is low, which may be the reason for the high values. Normally, the calibration verification standard is closer to the midpoint of the calibration curve, but this study was pushing towards to lower limits with an on-column concentration of 0.02 µg/mL. Aramite I is just above the 20% limit at 0.481 µg/mL, while 7,12-dimethylbenz[a]anthracene is approximately half the

expected concentration at 0.22 µg/mL. All other compounds near 7,12-benz[a]anthracene are within the 20% limit, and it is unclear why this result is very low. For the replicate injections in soil, all but two compounds have a %RSD for the replicate injections below 10%, indicating the method is robust, even when running samples in matrix.

For the average concentrations in matrix, 17 compounds are outside the ±20% limit; 5 of these compounds are just above 0.48 µg/mL (less than 0.49 µg/mL), which may be minor signal enhancements from the matrix. Ten of these compounds are within 140% of the expected concentration of 0.4 µg/mL; furthermore, when the recovery percentage is calculated comparing the soil concentration to the solvent concentration, only six compounds fall outside of a ±20% recovery range, which again suggests signal enhancement. Bis(2-ethylhexyl) phthalate has a reported average concentration of 0.89 µg/mL, suggesting that there was bis(2-ethylhexyl) phthalate in the soil matrix. On the other hand, famphur appears to be suppressed by the matrix, as the average concentration in matrix was 0.272 µg/mL, but 0.402 µg/mL in solvent. In summary, for the soil matrix testing, we can easily detect the 0.4 µg/mL calibration verification standard consistently in matrix with over 85% of the compounds reporting inside the ±20% calibration range requirement. Typically, calibration verification is completed in solvent, where more than 95% of the compounds are inside the ±20% calibration range requirement.

Table 7. Comparison of the solvent-calculated concentration of the 0.4 µg/mL calibration verification standard, the average concentration (10 replicate injections) of the 0.4 µg/mL standard in soil matrix, the %RSD of the 10 replicate injections, and recovery percentage of the 0.4 µg/mL standard in matrix compared to solvent.

No.	Name	Calculated Concentration (0.4 µg/mL in Solvent)	Average Concentration in Matrix of 0.4 µg/mL Spike	%RSD of 10 Replicates	Recovery in matrix
1	NDMA	0.45	0.47	1.95%	104%
2	Pyridine	0.46	0.45	2.68%	97%
3	2-Picoline	0.45	0.45	2.54%	100%
4	N-Nitroso-N-methylethylamine	0.44	0.46	1.75%	106%
5	Methyl methanesulfonate	0.47	0.46	0.31%	99%
6	2-Fluorophenol	0.46	0.45	0.94%	99%
7	N-Nitroso-N-diethylamine	0.46	0.46	1.37%	100%
8	Ethyl methanesulfonate	0.45	0.45	0.68%	99%
9	Phenol-d ₆	0.46	0.45	0.67%	99%
10	Phenol	0.46	0.44	1.73%	96%
11	Aniline	0.46	0.46	1.51%	100%
12	bis(2-Chloroethyl)ether	0.46	0.45	0.87%	99%
13	2-Chlorophenol	0.44	0.45	1.28%	101%

No.	Name	Calculated Concentration (0.4 µg/mL in Solvent)	Average Concentration in Matrix of 0.4 µg/mL Spike	%RSD of 10 Replicates	Recovery in matrix
14	1,3-Dichlorobenzene	0.46	0.46	0.56%	100%
15	1,4-Dichlorobenzene	0.47	0.46	0.57%	98%
16	Benzyl alcohol	0.42	0.45	2.08%	108%
17	1,2-Dichlorobenzene	0.47	0.46	0.87%	99%
18	2-Methylphenol (o-cresol)	0.44	0.44	1.50%	99%
19	bis(2-Chloro-1-methylethyl)ether	0.47	0.46	4.86%	97%
20	N-Nitrosopyrrolidine	0.45	0.47	3.45%	103%
21	4-Methylphenol (p-Cresol)	0.40	0.42	1.65%	104%
22	Acetophenone	0.45	0.45	1.71%	100%
23	N-Nitrosodi-n-propylamine	0.42	0.43	5.84%	103%
24	4-Nitrosomorpholine	0.42	0.45	3.11%	107%
25	o-Toluidine	0.47	0.47	1.44%	99%
26	Hexachloroethane	0.44	0.48	2.32%	109%
27	Nitrobenzene-d ₅	0.43	0.49	2.66%	112%
28	Nitrobenzene	0.43	0.48	3.02%	110%
29	N-Nitrosopiperidine,	0.42	0.43	2.72%	104%
30	Isophorone	0.43	0.44	1.53%	103%
31	2-Nitrophenol	0.46	0.49	2.06%	106%
32	2,4-Dimethylphenol	0.43	0.43	1.30%	100%
33	bis(2-Chloroethoxy)methane	0.44	0.44	0.54%	101%
34	2,4-Dichlorophenol	0.40	0.43	0.92%	106%
35	1,2,4-Trichlorobenzene	0.46	0.46	0.56%	100%
37	Naphthalene	0.47	0.46	0.66%	98%
38	4-Chloroaniline	0.45	0.46	1.13%	102%
39	2,6-Dichlorophenol	0.41	0.44	1.32%	106%
40	Hexachlorobutadiene	0.46	0.46	0.52%	100%
41	p-Phenylenediamine	0.45	0.44	3.75%	97%
42	N-Nitrosodi-n-butylamine	0.42	0.44	1.67%	104%
43	4-Chloro-3-methylphenol	0.43	0.43	1.45%	101%
44	2-Methylnaphthalene	0.47	0.47	0.60%	99%
45	Hexachlorocyclopentadiene	0.41	0.40	3.72%	96%
46	1,2,4,5-Tetrachlorobenzene	0.47	0.47	1.39%	99%
47	2,4,6-Trichlorophenol	0.42	0.43	1.47%	103%
48	2,4,5-Trichlorophenol	0.41	0.39	4.58%	97%
49	2-Fluorobiphenyl	0.47	0.46	0.74%	99%
50	1-Chloronaphthalene	0.47	0.46	0.78%	98%
51	2-Chloronaphthalene	0.47	0.46	1.55%	98%
52	2-Nitroaniline	0.44	0.53	0.90%	120%
53	Dimethyl phthalate	0.42	0.44	0.92%	106%
54	2,6-Dinitrotoluene	0.44	0.47	2.90%	106%
55	Acenaphthylene	0.44	0.43	2.28%	99%
56	m-Nitroaniline	0.39	0.43	4.35%	112%
57	Acenaphthene	0.48	0.46	1.14%	95%
59	Pentachlorobenzene	0.46	0.45	1.85%	98%
60	4-Nitrophenol	0.37	0.44	3.35%	120%

No.	Name	Calculated Concentration (0.4 µg/mL in Solvent)	Average Concentration in Matrix of 0.4 µg/mL Spike	%RSD of 10 Replicates	Recovery in matrix
61	Dibenzofuran	0.47	0.46	0.58%	99%
62	2,4-Dinitrotoluene	0.42	0.44	3.98%	105%
63	1-Naphthylamine	0.37	0.47	1.19%	126%
64	2,3,4,6-Tetrachlorophenol	0.40	0.42	1.79%	106%
65	2-Naphthylamine	0.40	0.44	1.66%	110%
66	Diethyl phthalate	0.41	0.45	1.02%	111%
67	Fluorene	0.47	0.47	0.82%	101%
68	Thionazin	0.42	0.46	2.38%	109%
69	5-Nitro- <i>o</i> -toluidine	0.40	0.45	8.22%	114%
70	4-Chlorophenyl phenyl ether	0.48	0.46	1.00%	96%
71	4-Nitroaniline	0.43	0.38	7.92%	88%
72	2-Methyl-4,6-dinitrophenol (DNOC)	0.46	0.52	5.22%	112%
73	N-Nitrosodiphenylamine	0.46	0.46	0.97%	101%
74	Diphenylamine	0.45	0.47	0.94%	104%
75	Azobenzene	0.47	0.50	2.62%	107%
76	2,4,6-Tribromophenol	0.42	0.43	3.11%	104%
77	Sulfotep	0.53	0.52	4.03%	97%
78	Dimethoate	0.64	0.52	12.70%	81%
79	Diallate I	2.70	0.53	2.91%	102%
80	Phorate	0.47	0.53	2.47%	111%
81	Phenacetin	0.42	0.44	1.40%	105%
82	4-Bromophenyl phenyl ether	0.45	0.44	2.94%	98%
83	Hexachlorobenzene	0.46	0.46	1.43%	100%
85	Pentachloronitrobenzene	0.41	0.46	3.62%	111%
86	4-Aminobiphenyl	0.44	0.45	1.56%	103%
87	Propyzamide	0.40	0.43	1.92%	107%
88	Phenanthrene	0.48	0.48	0.67%	101%
89	Dinoseb	0.42	0.43	3.59%	103%
90	Disulfoton	0.43	0.48	2.15%	111%
91	Anthracene	0.44	0.46	1.26%	104%
92	Parathion-methyl	0.42	0.40	1.25%	94%
93	Di- <i>n</i> -butyl phthalate	0.38	0.41	1.25%	106%
94	4-Nitroquinoline-1-oxide	0.42	0.41	11.49%	97%
95	Parathion	0.41	0.45	2.50%	112%
96	Fluoranthene	0.47	0.47	0.79%	100%
97	Benzidine	0.42	0.45	7.96%	105%
98	Pyrene	0.47	0.48	0.38%	101%
99	<i>p</i> -Terphenyl- <i>d</i> ₁₄	0.46	0.46	0.82%	101%
100	Aramite I	0.48	0.51	2.28%	106%
101	Aramite II	0.48	0.50	2.85%	105%
102	<i>p</i> -(Dimethylamino)azobenzene	0.47	0.51	2.10%	108%
103	Chlorobenzilate	0.41	0.45	1.07%	108%
104	Famphur	0.40	0.27	3.75%	68%
105	3,3'-Dimethylbenzidine	0.46	0.47	2.96%	101%
106	Butyl benzyl phthalate	0.40	0.43	1.32%	109%

No.	Name	Calculated Concentration (0.4 µg/mL in Solvent)	Average Concentration in Matrix of 0.4 µg/mL Spike	%RSD of 10 Replicates	Recovery in matrix
107	Benz[a]anthracene	0.44	0.45	0.31%	101%
108	3,3'-Dichlorobenzidine	0.41	0.43	2.23%	105%
109	Chrysene	0.47	0.47	0.62%	99%
110	bis(2-Ethylhexyl) phthalate	0.44	0.89	1.80%	205%
111	Di- <i>n</i> -octyl phthalate	0.43	0.45	1.37%	104%
112	Benzo[b]fluoranthene	0.44	0.46	1.25%	105%
113	7,12-Dimethylbenz[a]anthracene	0.22	0.40	1.83%	182%
114	Benzo[k]fluoranthene	0.46	0.43	2.74%	94%
115	Benzo[a]pyrene	0.41	0.42	2.09%	103%
116	3-Methylcholanthrene	0.40	0.41	1.34%	104%
117	Dibenz[a,j]acridine	0.44	0.46	1.56%	104%
118	Indeno[1,2,3-cd]pyrene	0.41	0.42	1.01%	104%
119	Dibenz[a,h]anthracene	0.43	0.44	3.11%	103%
120	Benzo[g,h,i]perylene	0.43	0.44	1.87%	104%

Conclusion

Due to the high sensitivity achieved with MRM mode and the inertness of the Agilent HydroInert source with H₂ carrier gas, 92.5% of the 120 tested compounds were detected and calibrated in the normal calibration range for EPA method 8270E from 0.1 to 100 µg/mL, and 77 compounds reached the extended calibration range of 0.02 to 100 µg/mL. Additionally, only 16 compounds required curve fits to pass EPA Method 8270E calibration criteria. Method criteria for EPA method 8270E were met for initial calibration over a working range of 0.02 to 100 µg/mL in a single 12-minute run using H₂ carrier gas and the HydroInert source, while retaining mass spectral fidelity and existing MRM transitions for compounds susceptible to H₂ reactivity.

References

1. Semivolatile Organic Compounds by Gas Chromatography/Mass Spectrometry (GC/MS); Method 8270D. *United States Environmental Protection Agency*, Revision 4, February **2007**.
2. Semivolatile Organic Compounds by Gas Chromatography/Mass Spectrometry (GC/MS); Method 8270E. *United States Environmental Protection Agency*, Revision 4, June **2018**.
3. Churley, M.; Quimby, B.; Andrianova, A. A Fast Method for EPA 8270 in MRM Mode Using the 7000 Series Triple Quadrupole GC/MS, *Agilent Technologies application note*, publication number 5994-0691EN, **2019**.

www.agilent.com

DE73549906

This information is subject to change without notice.

© Agilent Technologies, Inc. 2022
 Printed in the USA, May 27, 2022
 5994-4891EN

Volatile Organic Compounds Analysis in Drinking Water with Headspace GC/MSD Using Hydrogen Carrier Gas and HydroInert Source



Author

Bruce D. Quimby, PhD, and
Anastasia A. Andrianova, PhD
Agilent Technologies, Inc.

Abstract

An Agilent 8890/5977C GC/MSD system coupled with an Agilent 8697 headspace sampler was successfully used with hydrogen carrier gas for the analysis of volatile organic compounds (VOCs) in drinking water. Recent concerns with the price and availability of helium have led laboratories to look for alternative carrier gases for their GC/MS methods. For GC/MS, hydrogen is the best alternative to helium, and offers potential advantages in terms of chromatographic speed and resolution. However, hydrogen is not an inert gas, and may cause chemical reactions in the mass spectrometer electron ionization (EI) source. This can lead to disturbed ion ratios in the mass spectrum, spectral infidelity, peak tailing, and nonlinear calibration for some analytes. Therefore, a new EI source for GC/MS and GC/MS/MS was developed, and optimized for use with hydrogen carrier gas. The new source, named HydroInert, was used in the system evaluated here. In addition to the new source, the chromatographic conditions were optimized to provide separation of 80 volatile compounds in 7 minutes. Standards and samples were analyzed in both scan and SIM data acquisition modes. For the scan data, spectra were deconvoluted with MassHunter Unknowns Analysis software and searched against NIST 20 to assess the spectral fidelity. In both modes, quantitative calibration was performed for the 80 compounds over the range of 0.05 to 25 $\mu\text{g/L}$. As demonstrated in this note, the system gives excellent results for the analysis of VOCs in drinking water.

Introduction

One of the analyses commonly used to ensure that the quality of drinking water is the measurement of volatile organic compounds (VOCs). These compounds can appear in drinking water by contamination from numerous sources, including industrial and commercial operations. Another common source is when VOCs are formed by the addition of chlorine (used to disinfect the water), and react with natural organic matter in the source water. Regulations governing the allowable concentration of VOCs in drinking water vary by country and region, but are typically in the low $\mu\text{g/L}$ (ppb) range. Due to the large number of potential contaminants, and the need to measure them at such low levels, GC/MS systems are commonly used. GC/MS offers both the sensitivity and selectivity required to identify and quantify VOCs. Purge and trap¹ and static headspace^{2,3} are two commonly used automated sampling techniques that extract the VOC analytes from water samples and inject them into the GC/MS. This application note describes a system configured to perform static headspace/GC/MS analysis of VOCs in drinking water, optimized for using hydrogen as the carrier gas.

The system configured here was optimized for hydrogen carrier use, employing the following key components and techniques:

- Agilent J&W DB-624 Ultra Inert column: The DB-624 UI column, 20 m \times 0.18 mm, 1 μm (part number 121-1324UI) is designed to provide high chromatographic resolution of VOCs when using hydrogen carrier gas. This allowed the separation of 80 VOCs in under 7 minutes.
- The Agilent Inlet Liner, Ultra Inert, splitless, straight 1 mm id (part number 5190-4047) is necessary to connect the transfer line from the headspace unit to the GC column in the inlet. Use of wider inner diameter liners can cause broadening of analyte peaks with low split ratios like that used here.
- Pulsed split injection: Pulsed split injection is helpful in getting the injection bandwidth narrow enough to be compatible with the small diameter column used here. The technique allows a low split ratio, such as 21:1 used in this study, to maintain sensitivity while providing a high split flow during the injection, to rapidly sweep the headspace sample loop. Rapid sweeping of the loop is key to reducing peak broadening, especially for the earliest-eluting compounds.
- Agilent HydroInert source with 9 mm extractor lens: Because hydrogen is used as the carrier gas, the HydroInert source⁴ is used. This new EI extractor source was developed and optimized for use with hydrogen carrier gas, and greatly reduces in-source reactions that can cause problems with spectral infidelity, peak tailing, and nonlinear calibration for some analytes like nitrobenzene.
- Spectral deconvolution with Agilent MassHunter Unknowns Analysis software: The Agilent Unknowns Analysis software uses spectral deconvolution to extract clean analyte spectra from those of overlapping peaks. This results in higher library match scores, and greater confidence in peak identifications. NIST20 was used as the reference library.
- Addition of salt: The addition of salts like sodium chloride or sodium sulfate to aqueous headspace samples is commonly used to increase sensitivity of the analysis. The presence of the salt increases the amount of a compound that partitions into the gas phase. Sodium sulfate was chosen for this work.

Both scan and SIM modes of data acquisition were evaluated. Scan is useful for confirming the identity of found targets, and for identifying nontarget compounds. It can also be used retrospectively to search for compounds that may become of interest in the future. SIM has a substantial advantage in the signal-to-noise ratio, and is preferred where quantitation to low levels is required.

Experimental

The Agilent 5977C Inert Plus MSD was coupled to the Agilent 8890 GC equipped with a multimode inlet (MMI) and an Agilent 8697 headspace sampler. A HydroInert source (G7078-60930 for the fully assembled source with 9 mm lens) was used in the MSD, and autotuned using the etune tuning algorithm. The analytical method used an Agilent Ultra Inert straight-through 1.0 mm GC inlet liner (part number 5190-4047) and a DB-624 UI column, 20 m \times 0.18 mm, 1 μm (part number 121-1324UI). The 8697 Headspace Sampler was connected to the GC carrier gas inlet line between the GC control pneumatics and the GC injection port. A pulsed split injection was used with the split ratio set to 21:1.

Eight calibration levels ranging from 0.05 to 25 $\mu\text{g/L}$ were prepared in water by spiking 5 μL of a corresponding stock solution (which also included the ISTD) into 10.0 mL of water in a 20 mL headspace vial. Five grams of anhydrous sodium sulfate were weighed into each vial before the addition of water

and spiking solution. After capping, each vial was vortexed vigorously for 20 seconds, before placement in the headspace sampler. The spiking stock solutions were prepared in methanol using an Agilent 73-compound standard (DWM-525-1), an Agilent six-compound gas standard (DWM-544-1), and an Agilent three-compound ISTD mix (STM-320N-1), containing fluorobenzene (internal standard), 1,2-dichlorobenzene-d4 (surrogate), and BFB (surrogate). The ISTD/surrogate mix was added to each calibration stock solution at a level to give 5 µg/mL of each compound in the water. Agilent MassHunter Workstation software was used for data acquisition and processing. Figure 1 shows the system configuration used here. The operating parameters are listed in Table 1.

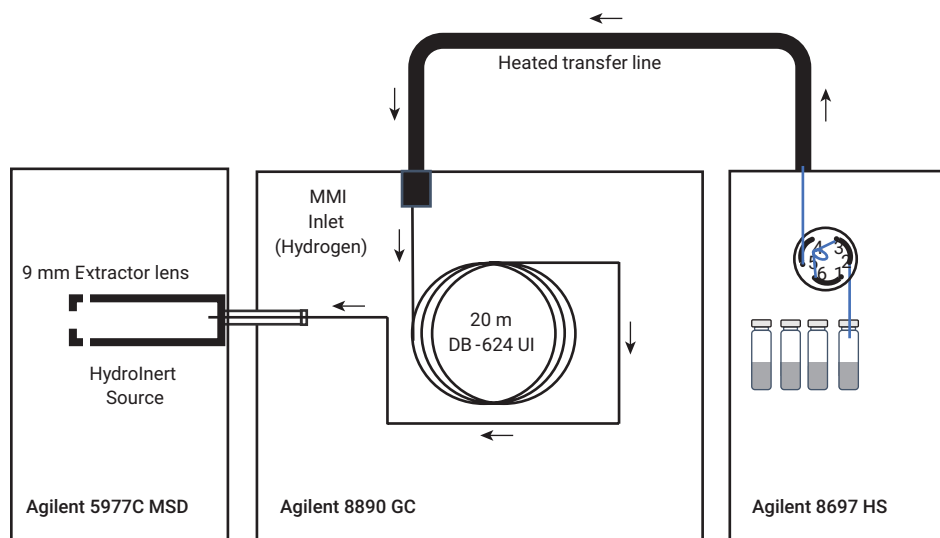

Figure 1. Instrument configuration.

Table 1. Gas chromatograph, mass spectrometer, and headspace sampler parameters for VOCs analysis.

Agilent 8890 GC Parameters		Agilent 8697 Headspace Sampler	
Parameters	Setpoints	8697 Loop Size	1 mL
Inlet Temperature	200 °C	Vial Pressurization Gas	Nitrogen
Liner	Agilent Ultra Inert inlet liner, splitless, straight, 1 mm id (p/n 5190-4047)	HS Loop Temperature	75 °C
Carrier Gas	Hydrogen	HS Oven Temperature	75 °C
Column Flow	0.95 mL/min constant flow	HS Transfer Line Temperature	115 °C
Injection Mode	Pulsed split	Vial Equilibration	12.00 min
Split Ratio	21:1	Injection Duration	0.30 min
Pulse Pressure	26 psig until 0.3 min	GC Cycle Time	15.00 min
Septum Purge Flow	3 mL/min	Vial Size	20 mL
Column	Agilent DB-624 Ultra Inert, 20 m × 0.18 mm, 1 µm (p/n 121-1324-UI)	Vial Shaking	Level 9, 250 shakes/min with acceleration of 980 cm/s ²
Oven Program	35 °C (0.25 min), ramp 25 °C/min to 240 °C (0.2 min) Run time 8.65 min	Fill Mode	Default
Agilent 5977C MSD		Fill Flow	50
MS Source	HydroInert Extractor with 9 mm Extractor Lens	Fill Pressure	10 psi
MS Tune	Etune	Pressure Equilibration Time	0.1 min
MSD Transfer Line Temperature	250 °C	Postinjection Purge	100 mL/min for 2 min
MS Source Temperature	250 °C		
MS Quad Temperature	200 °C		
Scan Range	35 to 260 Da		
Scan Speed	A/D samples 4, TID on		
EM Gain Factor (Scan mode)	5		
SIM Method Dwell Time	10 to 60 ms, varied by time segment to maintain minimum cycle time of 6.7 Hz		
EM Gain Factor (SIM Mode)	2		

Results and discussion

Scan results

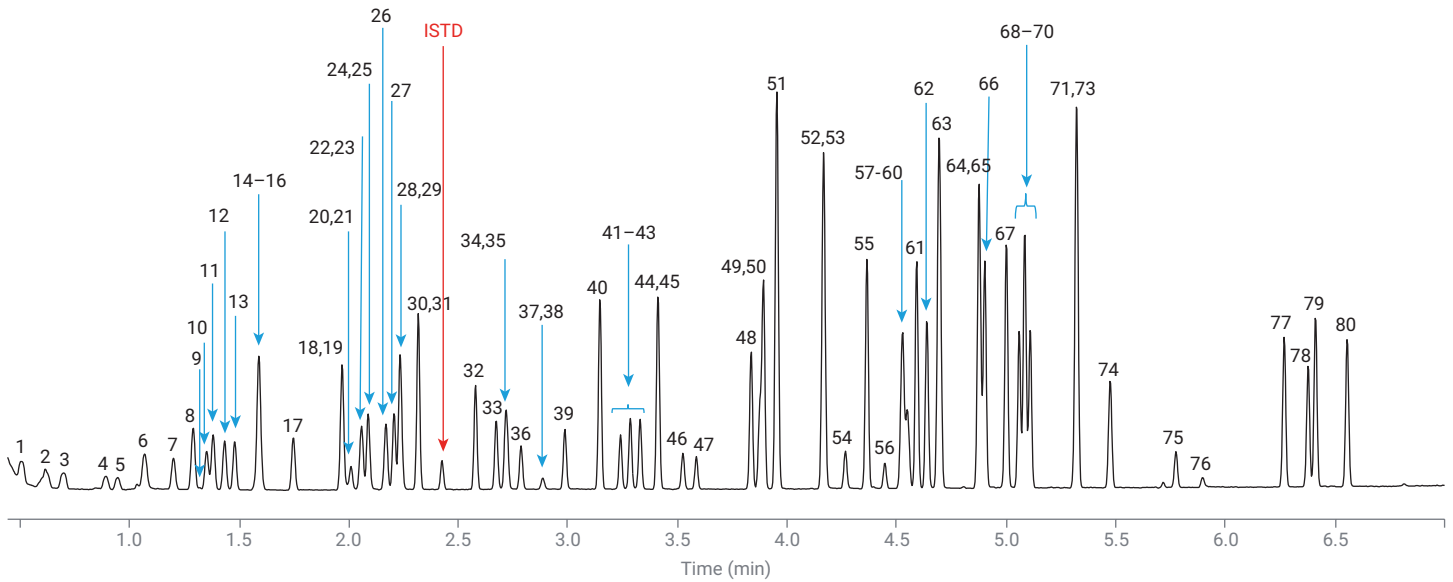

Figure 2. Total ion chromatogram (TIC) from the scan analysis of the 25 µg/L standard. The numbers identifying the peaks correspond to the first column in Table 2.

Table 2. Peak identifications, calibration results, and deconvoluted library match scores against NIST20 for the scan analysis.

Peak No.	Compound	RT (min)	Tgt m/z	Q1	Avg. RF RSD	CF Limit Low (µg/L)	CF Limit High (µg/L)	CF R ²	CF	CF Weight	Rel. Std. Error	LMS NIST20	
	Fluorobenzene [ISTD]	2.425	96	77								97	
1	Dichlorodifluoromethane	0.508	85	87	12.5	0.1	25	0.9989	Linear	1/x	17.3	92	
2	Chloromethane	0.615	50	52	14.4	0.25	25	0.9977	Linear	1/x	16.2	97	
3	Chloroethene	0.698	62	64	18.4	0.05	25	0.9995	Linear	1/x	9	91	
4	Bromomethane	0.891	94	96	21.7	1	25	0.9995	Linear	1/x	4.2	96	
5	Ethyl Chloride	0.945	64	66	13.6	0.25	25	0.9995	Linear	1/x	6.5	92	
6	Trichloromonofluoromethane	1.067	101	103	9.6	0.05	25	0.9994	Linear	1/x	9.6	96	
7	Ethyl ether	1.198	74	59	12.8	0.25	25	0.9992	Linear	1/x	11.4	97	
8	1,1-Dichloroethene	1.288	61	96	6.7	0.05	25	0.9993	Linear	1/x	7.3	98	
9	Acetone	1.317	58	43	112.5	1	25	0.9770	Linear	1/x	22.9	87	*
10	Iodomethane	1.350	142	127	14.6	0.05	25	0.9997	Linear	1/x	7.4	99	
11	Carbon disulfide	1.379	76		16.4	0.05	25	0.9997	Linear	1/x	5.7	95	
12	Allyl chloride	1.432	76	41	13.9	0.1	25	0.9982	Linear	1/x	17.2	97	
13	Methylene chloride	1.478	84	49	5.0	0.1	25	0.9996	Linear	1/x	5.1	97	
14	Acrylonitrile	1.572	52	53	16.1	0.5	25	0.9940	Linear	1/x	16.3	90	
15	<i>trans</i> -1,2-Dichloroethylene	1.586	61	96	15.9	0.05	25	0.9991	Linear	1/x	17.5	99	
16	Methyl tert-butyl ether	1.592	73	57	8.3	0.05	25	0.9991	Linear	1/x	9.6	98	
17	1,1-Dichloroethane	1.745	63	65	9.4	0.05	25	0.9998	Linear	1/x	5.2	97	
18	<i>cis</i> -1,2-Dichloroethylene	1.966	61	96	7.9	0.05	25	0.9998	Linear	1/x	6.1	95	
19	2,2-Dichloropropane	1.969	77	79	3.1	0.5	25	0.9994	Linear	1/x	3.7	80	**
20	Propanenitrile	1.993	54	52	14.5	0.5	25	0.9943	Linear	1/x	16.4	67	*
21	2-Propenoic acid, methyl ester	2.008	55	85	12.2	0.1	25	0.9991	Linear	1/x	8.5	97	

Peak No.	Compound	RT (min)	Tgt m/z	Q1	Avg. RF RSD	CF Limit Low (µg/L)	CF Limit High (µg/L)	CF R ²	CF	CF Weight	Rel. Std. Error	LMS NIST20	
22	Methylacrylonitrile	2.052	67	52	4.6	0.5	25	0.9994	Linear	1/x	4.4	95	
23	Bromochloromethane	2.059	130	128	15.4	0.1	25	0.9946	Linear	1/x	14.2	97	
24	Trichloromethane	2.086	83	85	7.0	0.1	25	0.9989	Linear	1/x	11.5	98	
25	Tetrahydrofuran	2.090	72	71	19.1	0.25	25	0.9959	Linear	1/x	10.3	96	
26	1,1,1-Trichloroethane	2.168	97	99	14.9	0.05	25	0.9995	Linear	1/x	9.6	98	
27	1-Chlorobutane	2.205	56	41	5.1	0.1	25	0.9997	Linear	1/x	6.6	97	
28	1,1-Dichloropropene	2.231	75	110	18.5	0.05	25	0.9980	Linear	1/x	13.8	96	
29	Carbon Tetrachloride	2.235	117	119	8.7	0.1	25	0.9983	Linear	1/x	9.4	96	
30	Benzene	2.315	78	77	10.4	0.05	25	0.9991	Linear	1/x	11.4	94	
31	1,2-Dichloroethane	2.316	62	64	15.5	0.05	25	0.9989	Linear	1/x	9.8	98	
32	Trichloroethylene	2.577	130	132	18.7	0.1	25	0.9981	Linear	1/x	12.4	99	
33	1,2-Dichloropropane	2.671	63	62	10.8	0.1	25	0.9997	Linear	1/x	9	98	
34	Methyl methacrylate	2.713	100	69	8.4	0.1	25	0.9991	Linear	1/x	10.5	98	
35	Dibromomethane	2.722	174	172	13.6	0.1	25	0.9989	Linear	1/x	18	98	
36	Bromodichloromethane	2.785	83	85	14.5	0.1	25	0.9997	Linear	1/x	4.1	98	
37	2-Nitropropane	2.883	43	41	19.4	0.5	25	0.9973	Linear	1/x	16.2	93	
38	Chloromethyl cyanide	2.887	75	77	51.4	1	25	0.9947	Linear	1/x	9.7	63	*
39	cis-1,3-Dichloropropene	2.985	75	110	12.9	0.1	25	0.9956	Linear	1/x	12.4	98	
40	Toluene	3.145	91	92	2.9	0.05	25	0.9995	Linear	1/x	4.3	99	
41	trans-1,3-Dichloropropene	3.239	75	110	7.1	0.05	25	0.9963	Linear	1/x	9.3	98	
42	Ethyl methacrylate	3.283	69	41	9.6	0.05	25	0.9989	Linear	1/x	10.5	98	
43	1,1,2-Trichloroethane	3.328	97	99	11.0	0.1	25	0.9994	Linear	1/x	7.8	98	
44	Tetrachloroethylene	3.410	164	166	10.0	0.1	25	0.9991	Linear	1/x	11.3	91	
45	1,3-Dichloropropane	3.412	76	78	17.9	0.05	25	0.9978	Linear	1/x	10.7	90	
46	Dibromochloromethane	3.524	129	127	6.0	0.1	25	0.9998	Linear	1/x	5.2	98	
47	1,2-Dibromoethane	3.585	109	107	6.9	0.25	25	0.9989	Linear	1/x	9.1	99	
48	Chlorobenzene	3.835	112	114	8.7	0.05	25	0.9951	Linear	1/x	12.8	99	
49	1,1,1,2-Tetrachloroethane	3.875	133	131	10.4	0.1	25	0.9968	Linear	1/x	14.4	96	
50	Ethylbenzene	3.892	91	106	5.6	0.05	25	0.9992	Linear	1/x	4.3	98	
51	m-Xylene	3.953	91	106	7.7	0.05	25	0.9991	Linear	1/x	4.6	99	
52	o-Xylene	4.164	91	106	6.7	0.05	25	0.9995	Linear	1/x	10.8	89	
53	Styrene	4.169	104	103	13.0	0.05	25	0.9972	Linear	1/x	8.8	96	
54	Tribromomethane	4.266	173	171	14.1	0.1	25	0.9993	Linear	1/x	11.2	99	
55	Isopropylbenzene	4.364	105	120	15.9	0.05	25	0.9978	Linear	1/x	6.9	98	
56	p-Bromofluorobenzene [SURR]	4.446	174	176								97	
57	1,1,2,2-Tetrachloroethane	4.521	83	85	9.4	0.1	25	0.9981	Linear	1/x	12.4	97	
58	Bromobenzene	4.530	158	156	11.4	0.1	25	0.9963	Linear	1/x	15.9	97	
59	1,2,3-Trichloropropane	4.548	110	112	8.5	0.25	25	0.9960	Linear	1/x	14.7	84	
60	trans-1,4-Dichloro-2-butene	4.555	89	88	9.9	0.25	25	0.9985	Linear	1/x	10.7	65	**
61	Propylbenzene	4.592	91	120	8.6	0.05	25	0.9989	Linear	1/x	8.1	98	
62	2-Chlorotoluene	4.638	91	126	7.9	0.05	25	0.9993	Linear	1/x	7.3	98	
63	Mesitylene	4.692	105	120	11.6	0.05	25	0.9972	Linear	1/x	8	91	
64	tert-Butylbenzene	4.876	134	91	17.4	0.25	25	0.9954	Linear	1/x	15.5	97	
65	Pentachloroethane	4.881	167	165	13.3	0.1	25	0.9967	Linear	1/x	17.2	86	
66	1,2,4-Trimethylbenzene	4.903	105	120	11.8	0.05	25	0.9975	Linear	1/x	8.4	98	
67	1-Methylpropyl benzene	5.001	105	134	19.0	0.05	25	0.9955	Linear	1/x	11.9	98	

Peak No.	Compound	RT (min)	Tgt m/z	Q1	Avg. RF RSD	CF Limit Low (µg/L)	CF Limit High (µg/L)	CF R ²	CF	CF Weight	Rel. Std. Error	LMS NIST20	
68	1,3-Dichlorobenzene	5.060	146	148	10.8	0.05	25	0.9979	Linear	1/x	13.3	99	
69	<i>p</i> -Cymene (4-Isopropyltoluene)	5.086	119	134	9.9	0.05	25	0.9994	Linear	1/x	6.9	97	
70	1,4-Dichlorobenzene	5.110	146	148	9.7	0.05	25	0.9979	Linear	1/x	17.2	99	
71	1,2-Dichlorobenzene-D4 [SURR]	5.313	152	150								78	**
72	<i>n</i> -Butylbenzene	5.322	91	92	9.5	0.1	25	0.9956	Linear	1/x	12.9	96	
73	1,2-Dichlorobenzene	5.325	146	148	12.0	0.05	25	0.9993	Quadratic	1/x	12.6	92	
74	Hexachloroethane	5.476	166	164	13.7	0.1	25	0.9979	Linear	1/x	14.4	97	
75	1,2-Dibromo-3-chloropropane	5.775	155	75	5.1	0.25	25	0.9982	Linear	1/x	8.2	98	
76	Nitrobenzene	5.896	77	51	15.6	1	25	0.9981	Linear	1/x	5.5	94	
77	1,2,4-Trichlorobenzene	6.270	180	182	13.5	0.05	10	0.9990	Linear	1/x	15.1	99	
78	1,1,2,3,4,4-Hexachlorobuta-1,3-diene	6.380	225	223	8.6	0.05	25	0.9997	Linear	1/x	9.6	91	
79	Naphthalene	6.413	128	127	7.1	0.05	25	0.9986	Linear	1/x	11.4	99	
80	1,2,3-Trichlorobenzene	6.558	180	182	13.4	0.05	25	0.9942	Linear	1/x	12.5	99	

* Library match score lower due to low response of compound.

** Library match score lower due to overlapping spectra not completely removed by deconvolution.

Initial calibration (ICAL) with scan data

The chromatographic parameters used in the method resulted in good separation of the 80 VOC compounds in less than 7 minutes, as shown in Figure 2. While there are overlapping peaks, their response was measured selectively with the quantifier ions chosen. Most compounds had sufficient response to be measured at or below 0.1 µg/L, and exhibit very good linearity. The average calibration range was 0.16 to 25 µg/L with an average R² of 0.9978. If necessary, the relative standard error (RSE) value was used to guide removal of the lowest, and in one case highest, calibration points, to achieve an RSE value of <20% (except for acetone). The average Response Factor RSD was <20 for 76 analytes. As expected, polar compounds with higher solubility in water were the worst performers. Acetone is an example, where it also had a contamination issue as observed in the blank, resulting in poor calibration results. A typical example is shown in Figure 3, with the lowest calibrator and calibration curve for iodomethane.

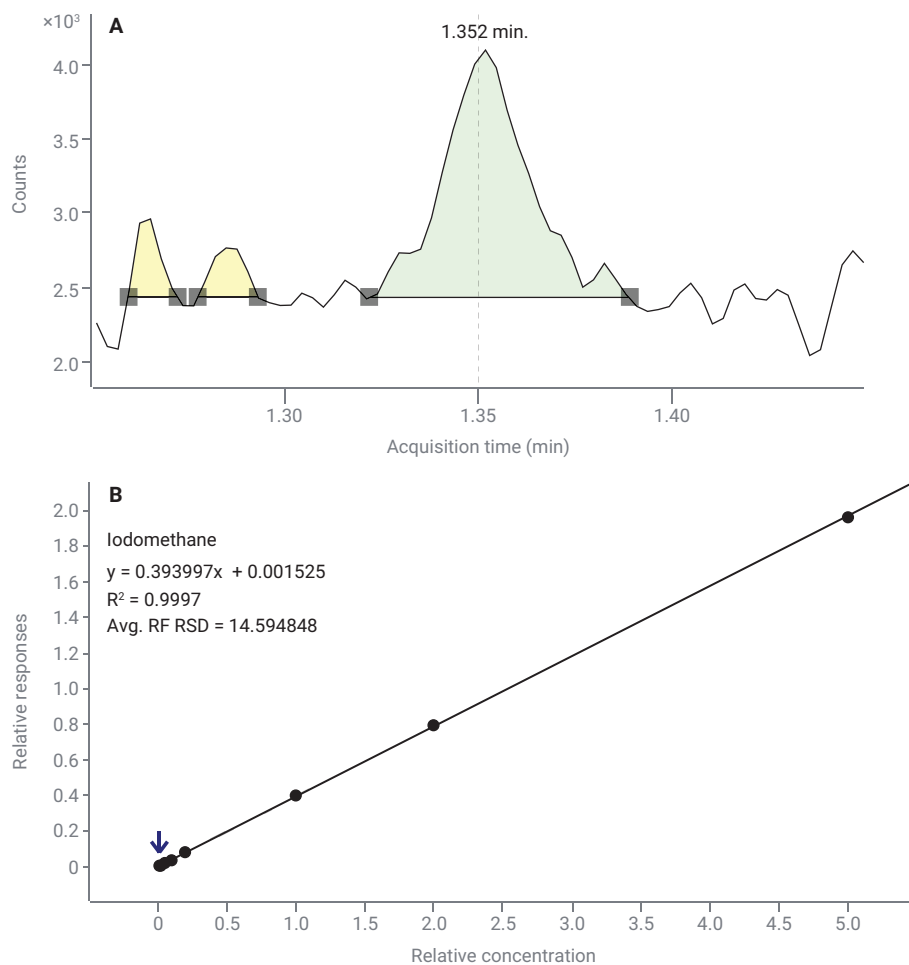

Figure 3. (A) quantifier EIC for iodomethane 0.05 µg/L calibration standard. (B) calibration curve for iodomethane from 0.05 µg/L to 25 µg/L.

Spectral fidelity

The 25 µg/L VOC standard was analyzed with the MassHunter Unknowns Analysis software, where spectra of the compounds were deconvoluted and searched against the NIST20 library. As seen in Table 2, the library match scores (LMS) are excellent, with an average of 94. There were only six compounds with LMS scores below 90, and these were due to low response and/or interference from overlapping peaks not completely removed by deconvolution. Nitrobenzene (compound 76 in Table 2) gave a very good LMS value of 94. Nitrobenzene reacts readily with hydrogen in a conventional MS source to produce

aniline⁴, resulting in low LMS values typically in the 60s. The HydroInert source greatly reduces in-source reactions with hydrogen, resulting in the high LMS value for nitrobenzene.

Initial calibration with SIM data

The results of the SIM mode calibration are listed in Table 3. As expected, for most compounds, SIM provided excellent calibration linearity and measurement at or below 0.05 µg/L. The average calibration range was 0.07 to 24 µg/L, with an average R² of 0.9990. If necessary, the relative standard error (RSE) value was used to guide removal of the lowest and highest calibration

points, to achieve an RSE value of <20%, and for choosing between a linear or quadratic fit. For some compounds, a linear fit would meet the <20% RSE criteria, but come close to the limit. However, use of a quadratic fit would significantly improve the RSE. For example, *tert*-butylbenzene had an RSE of 18.3 with a linear fit, but changing to quadratic lowered the RSE to 8.1. Similar improvements were seen with some of the other substituted benzenes as well. As observed with the scan data calibration, the average response factor RSD was <20 for 76 analytes.

SIM results

Table 3. Calibration results, and method detection limits (MDL) using SIM acquisition.

Peak No.	Compound Name	RT (min)	Tgt m/z	Q1	Avg. RF RSD	CF Limit Low (µg/L)	CF Limit High (µg/L)	CF R ²	CF	CF Weight	Rel. Std. Error	Conc. for MDL	MDL (µg/L)
	Fluorobenzene [ISTD]	2.425	96	77									
1	Dichlorodifluoromethane	0.508	85	87	15.3	0.05	25	0.9994	Linear	1/x	11.6	0.10	0.011
2	Chloromethane	0.615	50	52	7.3	0.1	25	0.9997	Linear	1/x	8.4	0.10	0.022
3	Chloroethene	0.698	62	64	4.1	0.05	25	0.9998	Linear	1/x	4.7	0.05	0.008
4	Bromomethane	0.891	94	96	4.1	0.05	25	0.9999	Linear	1/x	4.4	0.10	0.029
5	Ethyl Chloride	0.945	64	66	4.5	0.05	25	0.9998	Linear	1/x	4.7	0.05	0.010
6	Trichloromonofluoromethane	1.067	101	103	4.1	0.05	25	0.9997	Linear	1/x	4.3	0.05	0.008
7	Ethyl ether	1.198	74	59	6.4	0.05	25	0.9994	Linear	1/x	11	0.05	0.017
8	1,1-Dichloroethene	1.288	61	96	5.9	0.05	25	0.9996	Linear	1/x	5.3	0.05	0.006
9	Acetone	1.317	58	43	102.2	1	10	0.9994	Linear	1/x	3.5	[cont]	
10	Iodomethane	1.350	142	127	3.3	0.05	25	0.9992	Linear	1/x	4.8	0.05	0.006
11	Carbon disulfide	1.379	76		12.6	0.1	25	0.9994	Linear	1/x	4.6	0.05	0.003
12	Allyl chloride	1.432	76	41	4.9	0.05	25	0.9997	Linear	1/x	6.4	0.05	0.014
13	Methylene chloride	1.478	84	49	12.2	0.1	25	0.9999	Linear	1/x	5.2	0.05	0.007
14	Acrylonitrile	1.572	52	53	8.3	0.1	25	0.9999	Linear	1/x	5.4	[0.25]	
15	<i>trans</i> -1,2-Dichloroethylene	1.586	61	96	7.1	0.05	25	0.9997	Linear	1/x	5	0.05	0.007
16	Methyl <i>tert</i> -butyl ether	1.592	73	57	4.2	0.05	25	0.9995	Linear	1/x	7.5	0.05	0.003
17	1,1-Dichloroethane	1.745	63	65	3.7	0.05	25	0.9998	Linear	1/x	4.6	0.05	0.003
18	<i>cis</i> -1,2-Dichloroethylene	1.966	61	96	10.1	0.05	25	0.9996	Linear	1/x	7.3	0.05	0.007
19	2,2-Dichloropropane	1.969	77	79	3.6	0.05	25	0.9999	Linear	1/x	4.2	0.10	0.017
20	Propanenitrile	1.993	54	52	5.0	0.25	25	0.9996	Linear	1/x	4.3	[0.25]	
21	2-Propenoic acid, methyl ester	2.008	55	85	11.0	0.05	25	0.9996	Linear	1/x	14.8	0.10	0.029
22	Methylacrylonitrile	2.052	67	52	7.0	0.05	25	0.9988	Linear	1/x	11.4	0.10	0.032
23	Bromochloromethane	2.059	130	128	4.2	0.25	25	0.9991	Linear	1/x	3.5	0.10	0.019
24	Trichloromethane	2.086	83	85	12.2	0.25	10	0.9997	Linear	1/x	1.8	0.05	0.011
25	Tetrahydrofuran	2.090	72	71	3.3	0.05	25	0.9999	Linear	1/x	4.2	0.05	0.030

Peak No.	Compound Name	RT (min)	Tgt MZ	Q1	Avg. RF RSD	CF Limit Low (µg/L)	CF Limit High (µg/L)	CF R ²	CF	CF Weight	Rel. Std. Error	Conc. for MDL	MDL (µg/L)
26	1,1,1-Trichloroethane	2.168	97	99	4.9	0.05	25	0.9995	Linear	1/x	5.5	0.05	0.007
27	1-Chlorobutane	2.205	56	41	11.7	0.05	25	0.9997	Linear	1/x	7.3	0.05	0.007
28	1,1-Dichloropropene	2.231	75	110	7.3	0.05	25	0.9960	Linear	1/x	16.7	0.05	0.007
29	Carbon Tetrachloride	2.235	117	119	7.5	0.05	25	0.9974	Linear	1/x	13.1	0.05	0.015
30	Benzene	2.315	78	77	4.0	0.05	25	0.9998	Linear	1/x	3.5	0.05	0.004
31	1,2-Dichloroethane	2.316	62	64	3.0	0.05	25	0.9993	Linear	1/x	3.3	0.05	0.005
32	Trichloroethylene	2.577	130	132	5.6	0.05	25	0.9993	Linear	1/x	6.9	0.05	0.006
33	1,2-Dichloropropane	2.671	63	62	4.9	0.05	25	0.9998	Linear	1/x	4.6	0.05	0.011
34	Methyl methacrylate	2.713	100	69	9.4	0.05	25	0.9994	Linear	1/x	10.6	0.05	0.033
35	Dibromomethane	2.722	174	172	5.7	0.05	25	0.9996	Linear	1/x	6.3	0.05	0.009
36	Bromodichloromethane	2.785	83	85	3.0	0.05	25	0.9999	Linear	1/x	3.8	0.05	0.011
37	2-Nitropropane	2.883	43	41	8.9	0.1	25	0.9998	Linear	1/x	8.6	0.10	0.041
38	Chloromethyl cyanide	2.887	75	77	81.1	0.25	25	0.9997	Quadratic	1/x	7.6	[0.25]	
39	cis-1,3-Dichloropropene	2.985	75	110	3.8	0.05	10	0.9994	Linear	1/x	3.6	0.05	0.003
40	Toluene	3.145	91	92	5.2	0.05	25	0.9997	Linear	1/x	4	0.05	0.003
41	trans-1,3-Dichloropropene	3.239	75	110	6.3	0.05	25	0.9956	Linear	1/x	12	0.05	0.005
42	Ethyl methacrylate	3.283	69	41	4.6	0.05	25	0.9990	Linear	1/x	4.7	0.05	0.008
43	1,1,2-Trichloroethane	3.328	97	99	5.4	0.05	25	0.9998	Linear	1/x	2.5	0.05	0.034
44	Tetrachloroethylene	3.410	164	166	5.9	0.05	25	0.9994	Linear	1/x	9.9	0.05	0.005
45	1,3-Dichloropropane	3.412	76	78	5.8	0.05	25	0.9988	Linear	1/x	5.7	0.05	0.007
46	Dibromochloromethane	3.524	129	127	4.2	0.05	25	0.9999	Linear	1/x	4.6	0.05	0.008
47	1,2-Dibromoethane	3.585	109	107	8.1	0.05	25	0.9993	Linear	1/x	3.6	0.05	0.005
48	Chlorobenzene	3.835	112	114	6.6	0.05	25	0.9948	Linear	1/x	12.9	0.05	0.002
49	1,1,1,2-Tetrachloroethane	3.875	133	131	5.0	0.05	25	0.9991	Linear	1/x	9.1	0.05	0.007
50	Ethylbenzene	3.892	91	106	5.0	0.05	25	0.9994	Linear	1/x	4.7	0.05	0.005
51	m-Xylene	3.953	91	106	4.6	0.05	25	0.9996	Linear	1/x	4.2	0.05	0.001
52	o-Xylene	4.164	91	106	6.5	0.05	25	0.9999	Linear	1/x	4.9	0.05	0.004
53	Styrene	4.169	104	103	7.1	0.05	25	0.9988	Linear	1/x	6	0.05	0.005
54	Tribromomethane	4.266	173	171	5.4	0.05	25	0.9999	Linear	1/x	4.7	0.05	0.003
55	Isopropylbenzene	4.364	105	120	6.0	0.05	25	0.9981	Linear	1/x	6.2	0.05	0.004
56	p-Bromofluorobenzene [SURR]	4.446	174	176									
57	1,1,2,2-Tetrachloroethane	4.521	83	85	8.0	0.05	25	0.9999	Quadratic	1/x	4.8	0.05	0.006
58	Bromobenzene	4.530	158	156	7.1	0.05	25	0.9998	Linear	1/x	5.4	0.05	0.003
59	1,2,3-Trichloropropane	4.548	110	112	8.2	0.05	25	0.9970	Linear	1/x	12.2	0.05	0.024
60	trans-1,4-Dichloro-2-butene	4.555	89	88	13.0	0.25	25	0.9999	Linear	1/x	2.2	[0.25]	
61	Propylbenzene	4.592	91	120	5.4	0.05	25	0.9988	Linear	1/x	5.8	0.05	0.008
62	2-Chlorotoluene	4.638	91	126	4.1	0.05	25	0.9996	Linear	1/x	4.7	0.05	0.006
63	Mesitylene	4.692	105	120	5.9	0.05	25	0.9969	Linear	1/x	8.6	0.05	0.008
64	tert-Butylbenzene	4.876	134	91	10.5	0.05	25	0.9997	Quadratic	1/x	8.1	0.05	0.004
65	pentachloroethane	4.881	167	165	6.6	0.05	25	0.9953	Linear	1/x	6.6	0.05	0.009
66	1,2,4-Trimethylbenzene	4.903	105	120	6.8	0.05	25	0.9985	Linear	1/x	5.3	0.05	0.007
67	1-Methylpropyl benzene	5.001	105	134	5.3	0.05	10	0.9995	Linear	1/x	5.1	0.05	0.004
68	1,3-Dichlorobenzene	5.060	146	148	5.0	0.05	25	0.9990	Linear	1/x	7.6	0.05	0.003
69	p-Cymene (4-Isopropyltoluene)	5.086	119	134	5.1	0.05	25	0.9994	Linear	1/x	8.2	0.05	0.009
70	1,4-Dichlorobenzene	5.110	146	148	5.4	0.05	25	0.9985	Linear	1/x	8.5	0.05	0.004
71	1,2-Dichlorobenzene-D4 [SURR]	5.313	152	150									
72	n-Butylbenzene	5.322	91	92	9.8	0.05	25	0.9997	Quadratic	1/x	6.3	0.05	0.012

Peak No.	Compound Name	RT (min)	Tgt MZ	Q1	Avg. RF RSD	CF Limit Low (µg/L)	CF Limit High (µg/L)	CF R ²	CF	CF Weight	Rel. Std. Error	Conc. for MDL	MDL (µg/L)
73	1,2-Dichlorobenzene	5.325	146	148	5.4	0.05	10	0.9995	Linear	1/x	6.3	0.05	0.003
74	Hexachloroethane	5.476	166	164	5.0	0.05	25	0.9996	Linear	1/x	8.2	0.05	0.008
75	1,2-Dibromo-3-chloropropane	5.775	155	75	15.2	0.05	25	0.9991	Linear	1/x	7.9	0.05	0.017
76	Nitrobenzene	5.896	77	51	8.5	0.25	25	0.9992	Linear	1/x	9.3	[0.25]	
77	1,2,4-Trichlorobenzene	6.270	180	182	6.1	0.05	10	0.9996	Linear	1/x	5.5	0.05	0.007
78	1,1,2,3,4,4-Hexachlorobuta-1,3-diene	6.380	225	223	13.3	0.05	25	0.9996	Linear	1/x	5.9	0.05	0.006
79	Naphthalene	6.413	128	127	7.9	0.05	25	0.9989	Linear	1/x	8.9	0.05	0.003
80	1,2,3-Trichlorobenzene	6.558	180	182	4.0	0.05	10	0.9996	Linear	1/x	4.9	0.05	0.006

Figure 4 shows a typical example with the lowest calibrator and calibration curve for iodomethane. The improved signal-to-noise ratio provided by SIM, relative to that shown in Figure 3, is clear.

Method detection limits

An MDL study was performed after completion of the initial calibration. Eight trials were performed at the lowest level of calibration, 0.05 µg/L. The calculated MDLs were obtained by applying the formula shown in Equation 1. For compounds with higher reporting limits, eight trials were performed at the concentration of 0.1 µg/L. Table 3 lists the calculated MDLs for 80 VOCs. Six compounds had insufficient response, even at the 0.1 µg/L level, so the lowest calibration level used is listed instead in bold and square brackets. As noted in the scan results, acetone also had a contamination issue as observed in the blank, resulting in poor calibration results. The average MDL for the 80 compounds was 0.026 µg/L.

Equation 1. Formula for MDL calculations.

$$\text{MDL} = s \cdot t(n - 1, 1 - \alpha = 99) \\ = s \cdot 2.998$$

Where:

$t(n - 1, 1 - \alpha)$ = t value for the 99% confidence level with $n - 1$ degrees of freedom

n = number of trials (8)

s = standard deviation of the eight trials

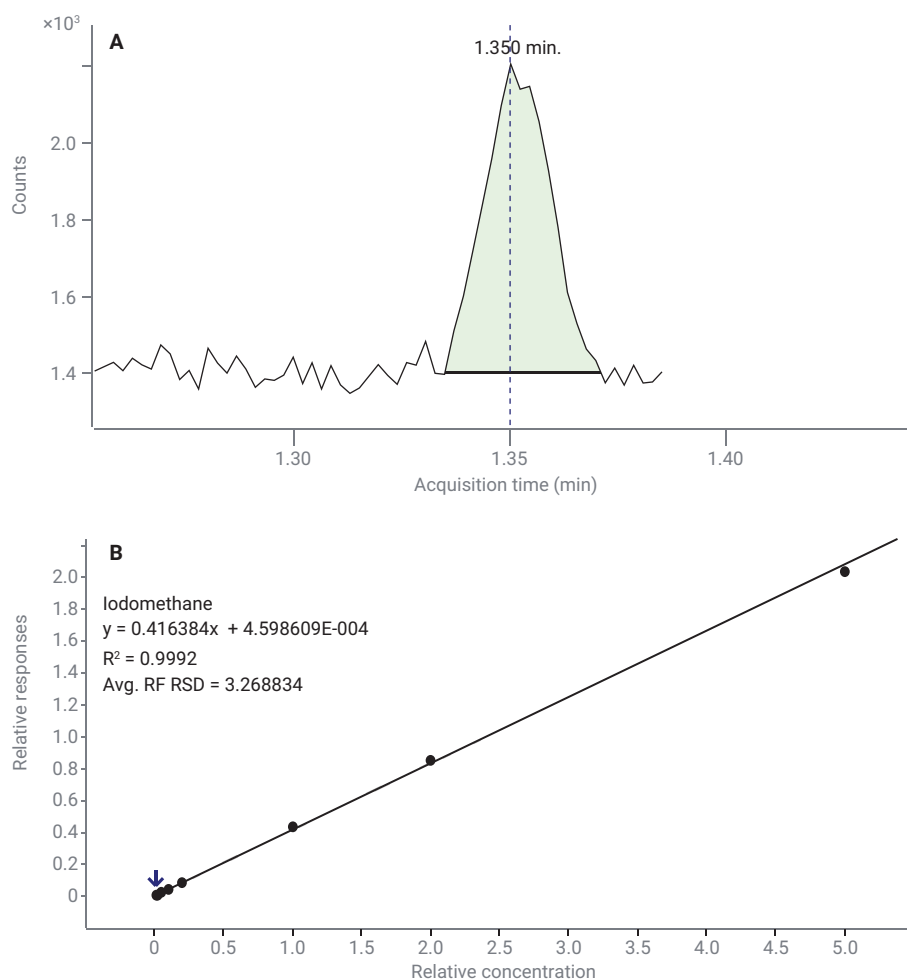

Figure 4. SIM results for iodomethane. (A) quantifier EIC for iodomethane 0.05 µg/L calibration standard. (B) calibration curve for iodomethane from 0.05 µg/L to 25 µg/L.

VOCs found in drinking water

Samples of municipal tap water from sources in the state of Pennsylvania were analyzed using both the scan and SIM methods. Several VOCs were identified with MassHunter Unknowns Analysis and by searching the deconvoluted spectra against the NIST20 library. The chromatograms from two of the samples are shown in Figure 5. The concentration of VOCs was determined using MassHunter Quantitative Analysis, with both the scan and SIM calibrations. The results are presented in Table 4.

Trichloromethane, bromodichloromethane, dibromochloromethane, and tribromomethane (collectively known as the trihalomethanes) are very common in municipal water treated with chlorine for disinfection purposes. They are the products of reaction between chlorine and naturally occurring humic and fulvic acids, often present in source water. All trihalomethanes were confirmed in both samples with precisely matching retention times, qualifier ion ratios, and, except for tribromomethane, with good LMS search results. As expected, LMS values decrease with decreasing concentration of the analyte. The *cis*-1,2-dichloroethylene and tetrachloroethylene are commonly found at trace levels in ground water from areas with a history of industrial activity. Methyl *tert*-butyl ether (MTBE) was an additive to gasoline several years ago, used in response to federal mandates requiring specified levels of organic oxygen in gasoline. Its use was later banned when it began showing up in ground water as the result of leaking underground storage tanks at gasoline stations.

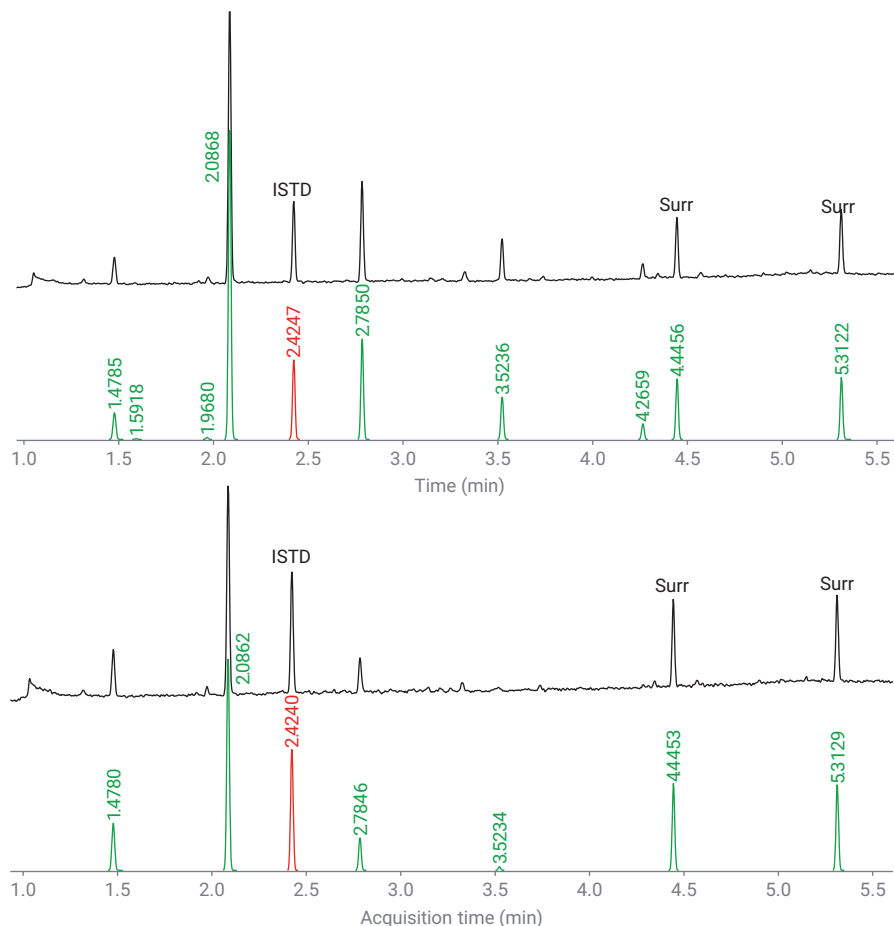

Figure 5. TIC (black) and deconvolution component (green) chromatograms of tap water samples. ISTD is shown in red. Top: Sample from Eastern Pennsylvania. Bottom: Sample from Southeastern Pennsylvania.

Table 4. Results from analysis of tap water samples.

Name	RT (min)	Eastern PA			Southeastern PA		
		Scan	Scan	SIM	Scan	Scan	SIM
		LMS NIST20	Conc. (µg/L)	Conc. (µg/L)	LMS NIST20	Conc. (µg/L)	Conc. (µg/L)
Methyl <i>tert</i> -butyl ether	1.592	56	0.08	0.08			
<i>cis</i> -1,2-Dichloroethylene	1.968	71	0.19	0.20			
Trichloromethane	2.087	98	43.47	44.08	97	21.03	20.90
Bromodichloromethane	2.785	98	21.81	22.07	92	4.82	4.85
Tetrachloroethylene	3.410			0.05			
Dibromochloromethane	3.524	98	11.34	10.80	68	0.69	0.69
Tribromomethane	4.266	97	3.97	3.71			0.02

Figure 6 shows the benefits of using both the scan and SIM methods on tap water samples. Spectral matching provides added confidence in the identification of compounds in the water samples. The scan data were processed in Agilent MassHunter Quantitative Unknowns Analysis software, which provides streamlined automated deconvolution and library searching. Previous approaches to processing scan data for library searching rely on comparing a baseline-subtracted apex spectrum of a peak to reference spectra. That approach can work well with a limited number of peaks, to identify

when there are no chromatographic interferences with the peak. However, samples containing significant levels of overlapping chromatographic peaks can interfere with the process, making analyte identification challenging. The automated deconvolution and library searching in MassHunter Unknowns Analysis greatly simplifies the processing of spectral data.

Figure 6 shows the extracted SIM quantifier ions and deconvoluted spectra for four of the seven VOCs found in the Eastern PA water sample. Dibromochloromethane [A] is confidently

identified with an RT that precisely matches that in the calibration table, an acceptable ratio of the qualifier to quantifier responses (not shown), and a very high library match score.

As the concentration of an analyte decreases, the signal-to-noise ratio in the both the spectra and quantifier chromatograms also decrease. In Figure 6, the spectral information is useful down to about 0.1 µg/L. The SIM data, which identifies using precise RT matching and the ratio of the qualifier to quantifier response can be used to lower levels.

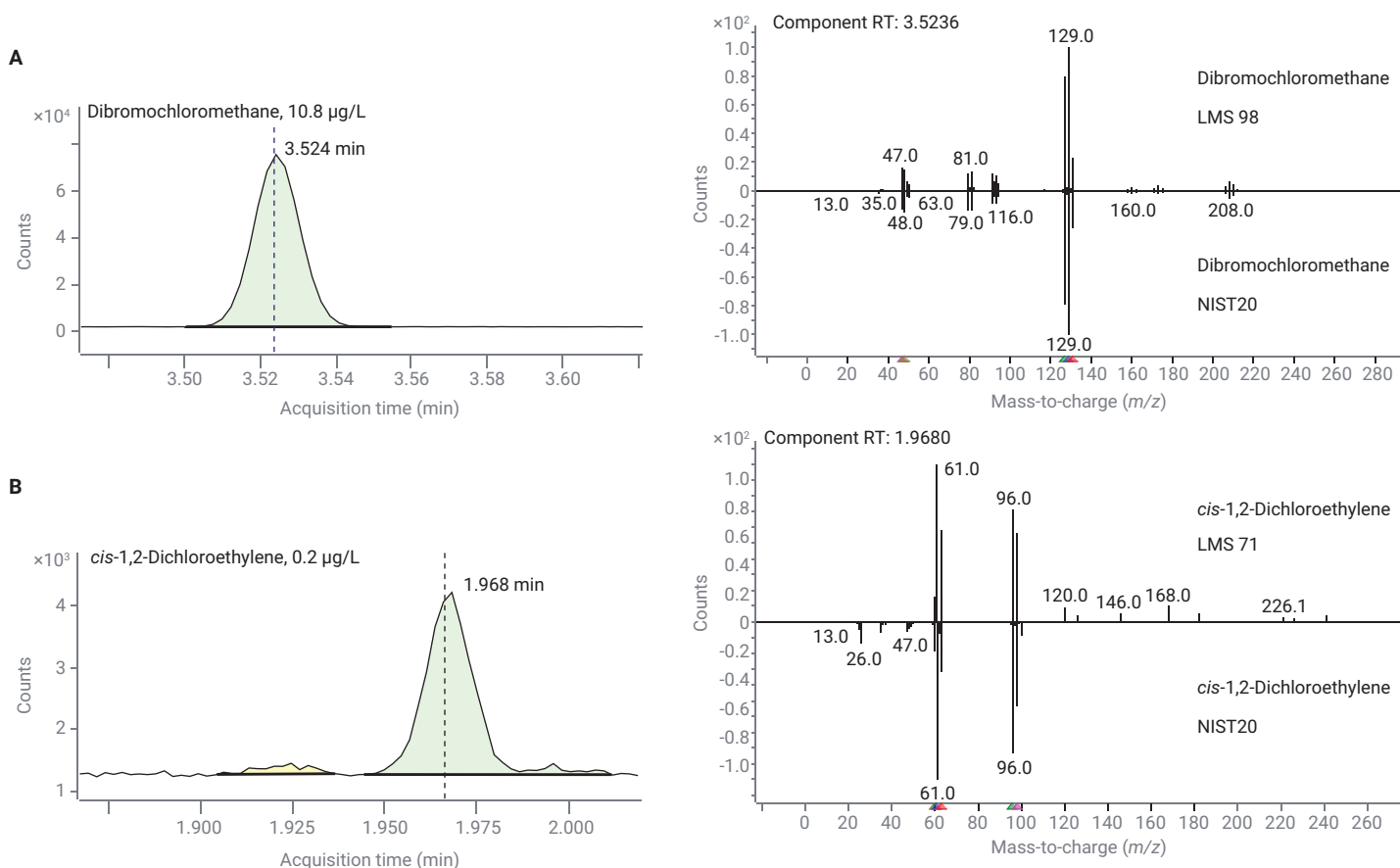
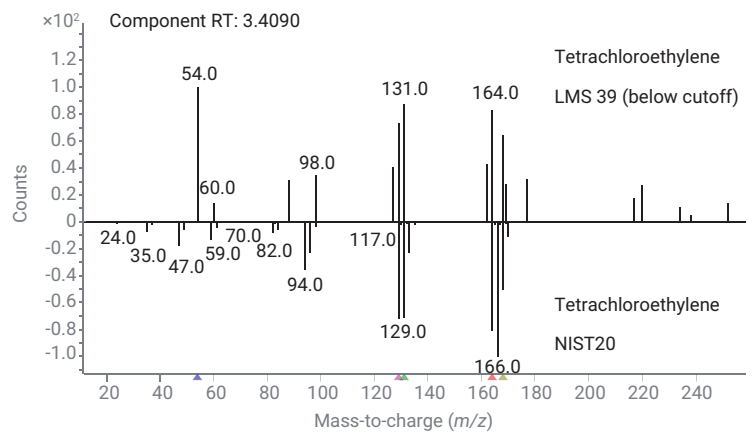
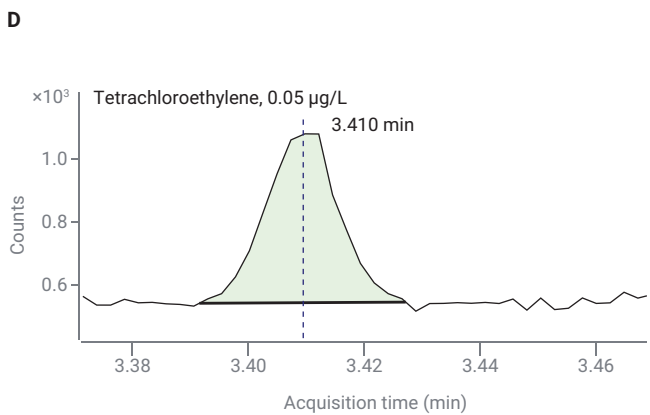
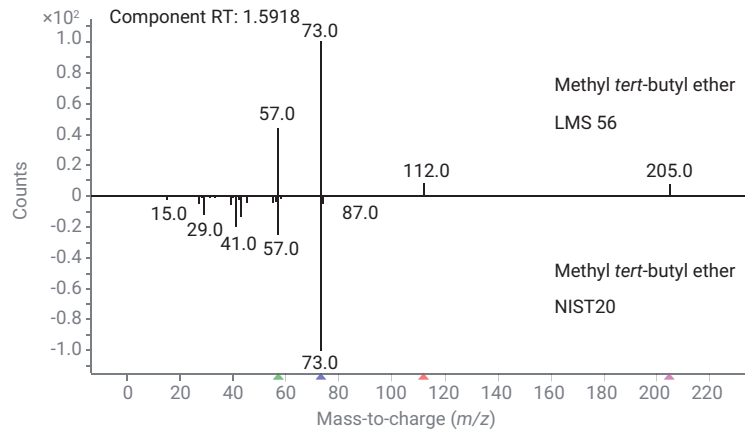
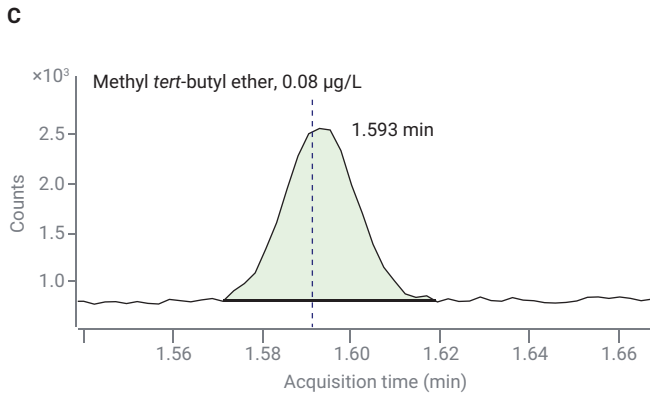

Figure 6. Quantifier ion extracted chromatograms from the SIM run and corresponding deconvoluted spectra from scan runs of the Eastern PA tap water sample (continued on next page).



Conclusion

The Agilent 8890/5977C GC/MSD system coupled with an Agilent 8697 headspace sampler was successfully used with hydrogen carrier gas for the analysis of volatile organic compounds (VOCs) in drinking water. While helium remains the preferred carrier gas for GC/MS, hydrogen has been shown here as a viable alternative if problems with the price and/or availability of helium arise. One of the key components

contributing to system performance is the new HydroInert source, which was designed specifically for hydrogen use. In addition to the new source, chromatographic conditions were optimized to provide separation of 80 volatile compounds in 7 minutes.

The results of the scan mode evaluation demonstrated excellent spectral matching against the NIST20 library, and excellent calibration linearity with an average range of 0.16 to 25 µg/L.

The results of the SIM mode evaluation demonstrated excellent calibration linearity with an average range of 0.07 to 25 µg/L, and an average MDL for the 80 compounds of 0.026 µg/L. The method described here gives results comparable to those observed with helium-based headspace methods in references 2 and 3.

The utility of the system was then demonstrated analyzing municipal tap water samples.

References

1. US EPA Method 524.2: Successful Measurement of Purgeable Organic Compounds in Drinking Water by Agilent 8860/5977B GC/MSD. *Agilent Technologies application note*, publication number 5994-0833EN, **2019**.
2. Improved Volatiles Analysis Using Static Headspace, the Agilent 5977B GC/MSD, and a High-Efficiency Source. *Agilent Technologies application note*, publication number 5991-6539EN, **2016**.
3. Fast Volatile Organic Compound Analysis of Drinking Water Using the Agilent 8697 Headspace Sampler in Tandem with Intuvo 9000 GC and 5977B GC/MSD. *Agilent Technologies application note*, publication number 5994-4449EN, **2021**.
4. Agilent Inert Plus HydroInert GC-MS System: Applying H₂ Carrier Gas to Real World GC-MS Analyses. *Agilent Technologies technical overview*, publication number 5994-4889EN, **2022**.

www.agilent.com

DE45493565

This information is subject to change without notice.

© Agilent Technologies, Inc. 2022
Printed in the USA, June 28, 2022
5994-4963EN

Analysis of Semivolatile Organic Compounds with US EPA 8270E Using the Agilent 7000E Triple Quadrupole GC/MS



Authors

Eric Fausett, Rachael Ciotti,
and Dale Walker
Agilent Technologies, Inc.

Abstract

This application note illustrates a sensitive method used to analyze semivolatile organic compounds (SVOCs) on an Agilent 7000E triple quadrupole GC/MS system (GC/TQ). The use of GC/TQ instrumentation for analysis of SVOCs offers significant advantages. High selectivity afforded by multiple reaction monitoring (MRM) mode results in faster batch review and increased confidence due to the elimination of matrix interferences. These interferences are often present when using selective ion monitoring (SIM) or scan acquisition modes. Increased sensitivity can facilitate smaller extraction volumes that improve sustainability, reduce waste, and decrease costs associated with sample preparation, solvent usage, and waste disposal. A primary objective of this work was to demonstrate the ability of a GC/TQ to detect SVOCs at low levels to meet these laboratory needs while maintaining an excellent dynamic range.

Introduction

The analysis of SVOCs can be challenging as there is a wide variety of target analytes that include bases, neutrals, and acids. These analytes span a wide range of molecular weights and boiling points. The United States Environmental Protection Agency (US EPA) has issued regulations and guidelines in Method 8270E for the analysis of these analytes by GC/TQ. Typical samples that are analyzed for SVOCs include surface or ground water as well as solid samples. These samples are then extracted before analysis. If method sensitivity can be improved, there is an opportunity to reduce sample and extract volumes that can result in decreased costs and increased lab sustainability. A preferable analytical method can also demonstrate a wide dynamic range to reduce the need for sample dilution and reanalysis.

Experimental

Sample preparation

A 2,000 µg/mL stock standard of SVOCs was sourced from Agilent (part number US201-1). Initial calibration curve standards were prepared by dilution of the stock and working standards into dichloromethane. Eleven calibration levels were prepared at the following concentrations: 0.005, 0.01, 0.025, 0.05, 0.1, 0.25, 0.5, 1, 2.5, 5, and 10 µg/mL. A 2,000 µg/mL internal standard (ISTD) solution was also sourced from Agilent (part number ISM-560-1). This solution contained six internal standards: 1,4-dichlorobenzene-d4, acenaphthene-d10, chrysene-d12, naphthalene-d8, phenanthrene-d10, and perylene-d12. This ISTD solution was diluted and added to the calibration vials at a concentration of 4 µg/mL.

Instrumental method

An Agilent 8890 GC system and 7693A automatic liquid sampler (ALS) were used for sample introduction. The 8890 GC was configured with a split/splitless (SSL) inlet. An **Agilent 7000E triple quadrupole mass spectrometer (TQ/MS)** was used as the detector.

Initial method parameters were obtained from two Agilent application notes.^{1,2} GC and MS method settings are shown in in the following tables.

The key techniques below were employed which increased method success:

- Using a GC/TQ provided greater sensitivity for low level analysis and simplified data reduction due to increased selectivity.

- A pulsed split injection with a 5:1 split ratio offered excellent sensitivity while preserving the advantages of a split injection.
- The 9 mm extractor lens enhanced linearity and improved overall performance for challenging analytes.
- Retention time locking protected against losing peaks, which may have otherwise drifted out of an MRM analysis window after column trimming.
- Dynamic MRM (dMRM) analysis mode reduced the number of simultaneous transitions that were monitored and simplified the process of adding and removing analytes.

GC Settings	
Analytical Column	Agilent J&W DB-8270D UI, 30 m x 0.25 mm, 0.25 µm (p/n 122-9732)
Injection Volume	1 µL
Inlet Temperature	Isothermal 280 °C
Injection Mode	Pulsed split
Split Ratio	5:1
Injection Pulse Pressure	30 psi until 0.6 min
Liner	Ultra Inert split, low pressure drop glass wool (p/n 5190-2295)
Oven Temperature Program	40 °C, hold for 0.5 min Ramp at 25 °C /min to 260 °C, hold 0 min Ramp at 5 °C /min to 280 °C, hold 0 min Ramp at 25 °C /min to 320 °C, hold 2 min
Run Time	16.9 min
Equilibration Time	1 min
Carrier Gas	Helium, constant flow at 1.55 mL/min (adjusted by RT locking)
Transfer Line Temperature	320 °C

MS Settings	
Ion Source	Extractor with 9 mm lens
Ion Source Temperature	300 °C
Quadrupole Temperature	150 °C
Collision Gas	Nitrogen at 1.5 mL/min
Quench Gas	Helium at 2.25 mL/min
Ionization Mode	EI
Solvent Delay	1.7 min
EMV mode	Gain factor
Gain Factor	3
Scan Type	Dynamic MRM

Several injection techniques were evaluated including split and splitless modes, with and without pulsed injections. A pulsed split injection with a 5:1 split ratio was selected as it offered excellent sensitivity while preserving the advantages of a split injection. Split injections allow for faster sample transfer from the inlet to the column. This faster transfer can improve performance for thermally sensitive analytes as they spend less time at high temperature in the GC inlet. Split injections also diminish the deposition of nonvolatile matter at the head of the GC column.

This method also used a 9 mm diameter extractor lens (part number G3870-20449) in the MS source. The 9 mm lens has been shown to significantly enhance method performance for polycyclic aromatic hydrocarbons and for many other challenging analytes such as 2,4-dinitrophenol by Anderson *et al.*³

The implementation of retention time locking (RTL) was critical to ensure exact retention time fidelity even after repeated inlet maintenance and column trimming. After trimming the column during maintenance, a single injection was made that allowed the Agilent MassHunter acquisition software for GC/MS systems to make a slight adjustment to the GC flow. This adjustment realigned all the analyte retention times. The method was retention time locked to acenaphthene-d10 at 7.08 minutes. This technique protects against losing peaks that may otherwise drift out of a dMRM analysis window after column maintenance.

The method also used dMRM acquisition mode. This approach addresses the limitations of time segment methods for a large batch of compounds by replacing the group segmentation with individual time windows for every analyte transition. It also dramatically reduces the number of individual MRM transitions that are monitored during each MS scan.⁴ Dynamic MRM mode simplifies the addition and removal of analytes of interest. The dMRM mode overcomes many challenges associated with time segmented methods targeting an abundance of analytes in a short elution window.

Early method experiments used a 25 °C oven ramp from 40 to 320 °C. The oven ramp was modified such that the oven ramp rate from 260 to 280 °C was decreased to 5 °C per minute. By optimizing the oven ramp, improved chromatographic resolution was achieved for benzo[b]fluoranthene and benzo[k]fluoranthene. Isomers are considered resolved if the height of the valley between two isomer peaks is less than 50% of the average of the two peak heights.⁵ As shown in Figure 1, 88.6% resolution was achieved at a concentration of 2.0 µg/mL. Indeno[1,2,3-cd]pyrene and dibenz[a,h]anthracene were also acceptably separated at 62.6% resolution, as shown in Figure 2.

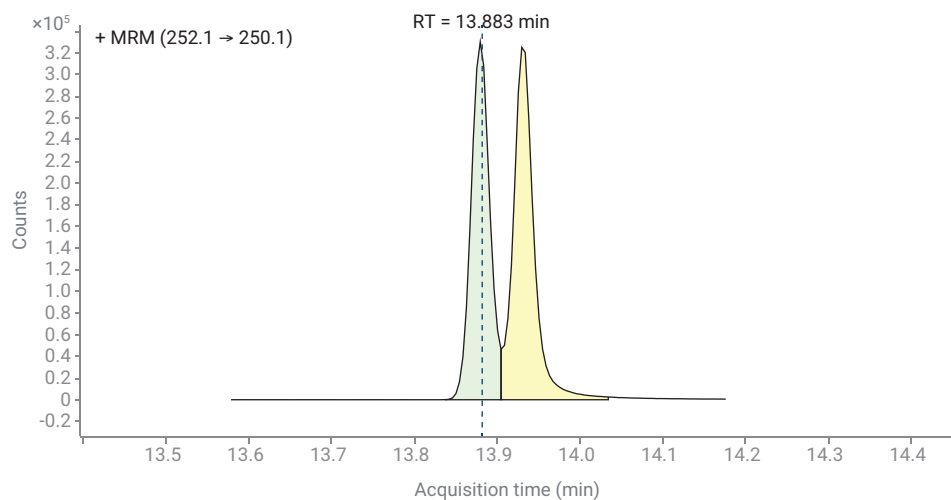

Figure 1. Benzo(b)fluoranthene and benzo(k)fluoranthene at 2.0 µg/mL (88.6% resolution).

Results and discussion

Manufacturer recommended tune

On a single quadrupole MS, the instrument would be challenged with a DFTPP (decafluorotriphenylphosphine) solution to verify mass accuracy and resolution. DFTPP tune checks are not appropriate for tandem MS analysis using MRM. However, the laboratory must demonstrate, prior to the initial calibration, that the MS system achieves mass accuracy and mass resolution criteria specified by the instrument manufacturer for the perfluorotributylamine (PFTBA) internal calibrant or another appropriate chemical.⁵ The MS tune was verified using the Agilent manufacturer recommended tune protocol for the GC/TQ. Figure 4 shows an example check tune report from the Agilent manufacturer recommended tune. This procedure assists the analyst in using the GC/TQ by generating tune evaluation tests and reports to quickly evaluate and document the operability of the MS system.

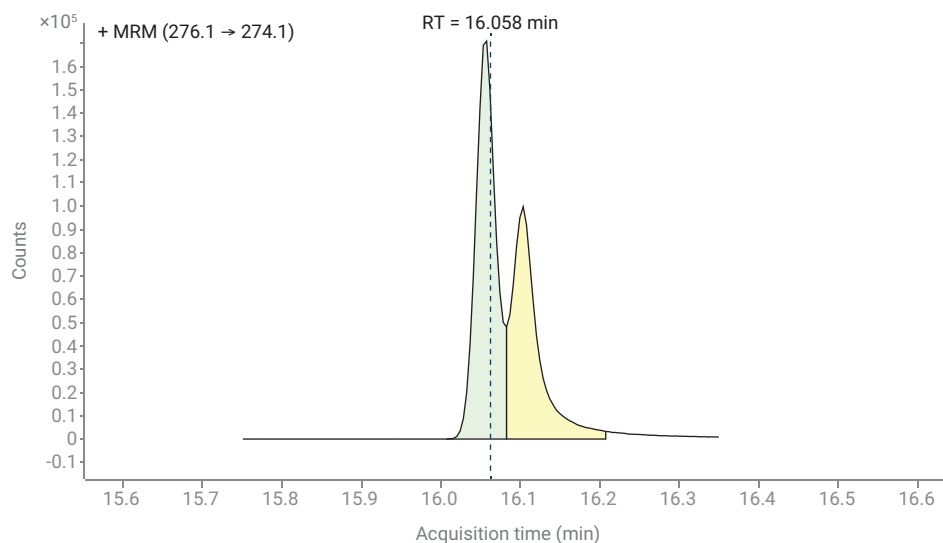

Figure 2. Indeno[1,2,3-cd]pyrene and dibenz[a,h]anthracene at 2.0 $\mu\text{g}/\text{mL}$ (62.6% resolution).

Calibration

The initial calibration included 74 analytes. The 3- and 4-methyl phenol isomers were not separated and were reported as a combined result. The initial calibration was performed by introducing 11 different calibration solutions across more than three orders of magnitude in

the range of 0.005 to 10 $\mu\text{g}/\text{mL}$. Each analyte was monitored using at least two MRM transitions, one of which was selected to quantify the results while the second was used as a qualifier. Some calibration curve ranges were trimmed at the top and/or bottom of the working range to meet method criteria.

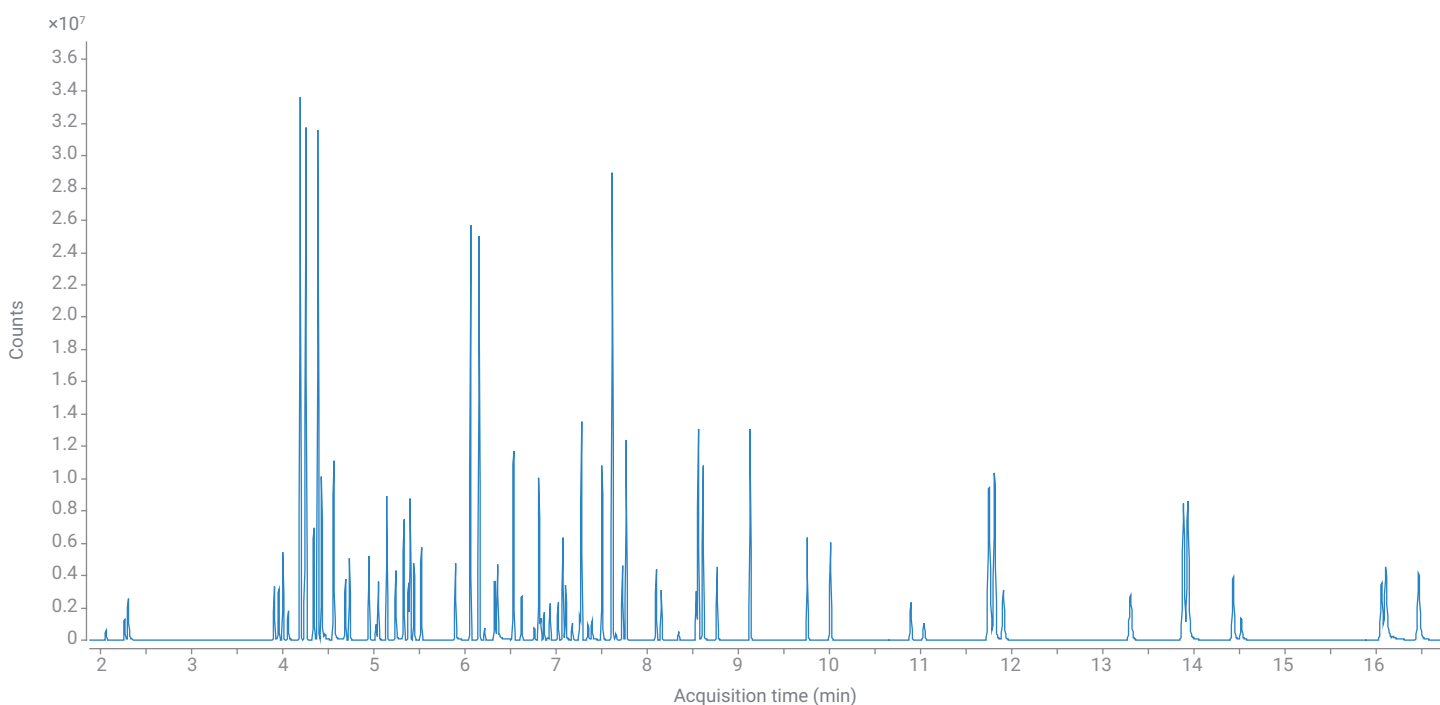

Figure 3. Total ion chromatogram from composite of all DMRM transitions showing separation in 16.9 minutes.

Triple Quadrupole GC/MS Checktune Report



Instrument Information EI with Extractor Ion Source – High Sensitivity Tune

MS Model	G7000E	Tune Timestamp	2022-03-30 11:30:51-04:00
Instrument Name		Save Timestamp	2022-03-30 11:30:56-04:00
SW/FW Version		Tune File	first.eiex
		Tune Level	Full Autotune

Instrument Actuals

Emission (µA)	35.1	Rough Vac (mTorr)	1.04E+2	Column 1 (mL/min)	1.550
Source Temp. (°C)	300	High Vac (Torr)	7.64E-5	Column 2 (mL/min)	0.000
MS1 Quad Temp. (°C)	150	Turbo 1 Speed (%)	100.0	Collision Cell (mL/min)	1.500
MS2 Quad Temp. (°C)	150	Turbo 1 Power (W)	0.0	Quench Flow (mL/min)	2.250
Transfer Line (°C)	320				

MS1/MS2 Quadrupole Checktune Results

Target Mass (m/z)	Actual Mass (m/z)		MS1 Abundance			MS2 Abundance		
	MS1	MS2	Abundance	Ratio %	Acceptable %	Abundance	Ratio %	Acceptable %
69.0	69.0	69.0	11,924,296	100.00	50.0 - 110.0	39,580,079	100.00	50.0 - 110.0
219.0	219.0	219.0	10,837,233	90.88	70.0 - 110.0	15,324,358	38.72	10.0 - 40.0
264.0	264.0	264.0	3,749,068	31.44	10.0 - 80.0	12,500,412	31.58	10.0 - 60.0
414.0	414.0	414.0	952,894	7.99	0.1 - 40.0	3,333,806	8.42	0.1 - 20.0
502.0	502.0	502.0	560,982	4.70	0.1 - 40.0	964,475	2.44	0.1 - 12.0

Isotope M+1 (m/z)	MS1 Abundance			MS2 Abundance		
	Iso M+1 Abund	Iso M+1 Ratio %	Acceptable %	Iso M+1 Abund	Iso M+1 Ratio %	Acceptable %
70.0	137,009	1.15	0.63 - 1.72	545,237	1.38	0.63 - 1.72
220.0	471,869	4.35	2.94 - 6.42	687,613	4.49	2.94 - 6.42
265.0	213,584	5.70	4.09 - 8.37	731,141	5.85	4.09 - 8.37
415.0	84,401	8.86	7.29 - 12.08	294,690	8.84	7.29 - 12.08
503.0	55,587	9.91	8.75 - 12.88	94,539	9.80	8.75 - 12.88

Detector Checktune Results

Detector Checktune Results	Value	Recommended Limit
EMV (V)	1158	≤ 2,900
Maximum Gain Factor	100	≥ 100

Air and Water Checktune Results

Air / Water	Absolute Abundance	Relative Abundance (%)	Recommended Limit
PFTBA(69)	11,357,567	100	---
Water	21,511	0.19	≤ 20
Oxygen	22,816	0.20	≤ 2.5
Nitrogen*	85,036	0.75	≤ 10

* Nitrogen values are calculated from oxygen abundance

Figure 4. Example check tune report for manufacturer recommended tune.

Some analytes in the 8270 list are prone to difficulty in calibration. These analytes may be labile or active in the GC inlet, particularly at lower concentrations. This may manifest as variation in response factor relative to analyte concentration. Section 1.4.7 of the 8270 method⁵ lists several such analytes and notes that they may be subject to erratic chromatographic behavior. 2,4-Dinitrophenol is one of the most difficult from this list and the calibration is shown in Figure 5. The response factor moderately increases with concentration, but method requirements were met as the average response factor (avg RF) relative standard deviation was 18.07%, which is less than the requirement of 20%. Method 8270 allows curve fitting for some analytes to alleviate this difficulty, provided that the coefficient of determination (R^2) is greater than 0.99. An alternate quadratic curve fit for 2-4-dinitrophenol is shown in Figure 6 with a R^2 of 0.9979. Pentachlorophenol is another of these listed potentially difficult analytes and the calibration curve is shown in Figure 8. In this case, a quadratic curve fit was selected with a R^2 value of 0.9966. These calibration curves demonstrate that calibration criteria may be met even with difficult analytes at low concentrations. An example of a more ideal calibration curve is shown for NDMA in Figure 9. NDMA itself can be a difficult analyte if chromatographic conditions are not optimized due to early elution and potential difficulty in complete resolution from the solvent. In this example, NDMA has an avg RF relative standard deviation of 5.71% and demonstrates exemplary linearity across the calibrated range.

Table 1. Calibration results.

Compound	Curve Fit	% RSE	R ²	Low Std (ppm)	High Std (ppm)
				(default is 0.005 to 10 ppm)	
1,2,4-Trichlorobenzene	Avg RF	5.7			
1,2-Dichlorobenzene	Avg RF	5.3			
1,3-Dichlorobenzene	Avg RF	4.5			
1,3-Dinitrobenzene	Avg RF	16.4		0.025	5
1,4-Dichlorobenzene	Avg RF	7.8			
1,4-Dinitrobenzene	Avg RF	11.8		0.025	
1-Methylnaphthalene	Avg RF	6.8			
2,2'-oxybis[1-chloropropane]	Avg RF	4.3		0.050	
2,3,4,6-Tetrachlorophenol	Avg RF	14.1			
2,3,5,6-Tetrachlorophenol	Avg RF	9.6		0.025	
2,4,5-Trichlorophenol	Avg RF	8.2			
2,4,6-Trichlorophenol	Avg RF	5.2			
2,4-Dichlorophenol	Avg RF	4.2			
2,4-Dimethylphenol	Avg RF	3.4		0.010	
2,4-Dinitrophenol	Avg RF	18.1		0.050	5
2,4-Dinitrotoluene	Quadratic	5.4	0.9967	0.025	
2,6-Dinitrotoluene	Quadratic	8.3	0.9937	0.010	
2-Chloronaphthalene	Avg RF	3.5			
2-Chlorophenol	Avg RF	6.5			
2-methyl-4,6-dinitrophenol	Avg RF	13.0		0.025	5
2-Methylnaphthalene	Avg RF	4.1			
2-Methylphenol	Avg RF	6.7		0.010	
2-Nitroaniline	Avg RF	10.4			
2-Nitrophenol	Avg RF	7.8			
3+4-Methylphenol	Avg RF	3.5			
3-Nitroaniline	Avg RF	14.7			5
4-bromophenyl phenyl ether	Avg RF	3.9			
4-chloro-3-methylphenol	Avg RF	4.9			
4-Chloroaniline	Avg RF	3.0			
4-Chlorophenyl phenyl ether	Avg RF	2.1			
4-Nitroaniline	Quadratic	7.0	0.9954		
4-Nitrophenol	Avg RF	11.9			5
Acenaphthene	Avg RF	9.8		0.010	
Acenaphthylene	Avg RF	4.3		0.010	
Aniline	Avg RF	7.6		0.010	
Anthracene	Avg RF	5.2			
Azobenzene	Avg RF	3.9			
Benz[a]anthracene	Avg RF	6.7			
Benzo[a]pyrene	Avg RF	7.9			
Benzo[b]fluoranthene	Avg RF	7.2			
Benzo[g,h,i]perylene	Avg RF	8.0			
Benzo[k]fluoranthene	Avg RF	8.7			
Benzyl alcohol	Avg RF	2.7		0.010	
bis(2-Chloroethoxy)methane	Avg RF	3.2			
bis(2-Chloroethyl)ether	Avg RF	7.1			

Compound	Curve Fit	% RSE	R ²	Low Std (ppm)	High Std (ppm)
				(default is 0.005 to 10 ppm)	
Bis(2-ethylhexyl) phthalate	Avg RF	14.3		0.025	
Butyl benzyl phthalate	Avg RF	10.3			
Carbazole	Avg RF	5.0			
Chrysene	Avg RF	5.7			
Dibenz[a,h]anthracene	Avg RF	14.4			5
Dibenzofuran	Avg RF	5.0			
Diethyl phthalate	Avg RF	7.6		0.100	
Dimethyl phthalate	Avg RF	4.1			
Di- <i>n</i> -butyl phthalate	Avg RF	3.2		0.025	
Di- <i>n</i> -octyl phthalate	Quadratic	6.2	0.9960		
Diphenylamine	Avg RF	4.9		0.025	
Fluoranthene	Avg RF	3.9			
Fluorene	Avg RF	3.0			
Hexachlorobenzene	Avg RF	7.1			
Hexachlorobutadiene	Avg RF	3.7			
Hexachlorocyclopentadiene	Avg RF	14.4		0.010	
Hexachloroethane	Avg RF	2.6		0.010	
Indeno[1,2,3- <i>cd</i>]pyrene	Avg RF	7.9			5
Isophorone	Avg RF	5.6			
Naphthalene	Avg RF	6.8			
NDMA	Avg RF	5.7		0.010	
Nitrobenzene	Avg RF	10.9		0.010	
N-Nitrosodi- <i>n</i> -propylamine	Avg RF	3.4		0.050	
Pentachlorophenol	Quadratic	6.7	0.9966	0.010	
Phenanthrene	Avg RF	5.7			
Phenol	Avg RF	5.7			
Pyrene	Avg RF	3.6			
Pyridine	Avg RF	5.2		0.025	
Average = 7.0					

In this data set, 69 of the 74 analytes were calibrated using an avg RF fit with a relative standard deviation of less than or equal to 20%. The remaining five analytes (2,4-dinitrotoluene, 2,6-dinitrotoluene, 4-nitroaniline, di-*n*-octyl phthalate, and pentachlorophenol) were calibrated using weighted least squares regression with quadratic fits having R² values above 0.99. The relative standard error

was calculated for each analyte and found to be less than or equal to 20% for each calibration curve. The mean relative standard error across all analytes was 6.96%. Also, the accuracy for all calibration points used was within ±30% of the theoretical value for each concentration. At least six data points were used for each calibration curve.

If a calibration working range is desired which covers higher concentrations, it is recommended to either dilute the samples or increase the ratio of the pulsed split injection. This modification would have the additional benefit of reducing matrix that reaches the column and detector and would likely reduce maintenance frequency.

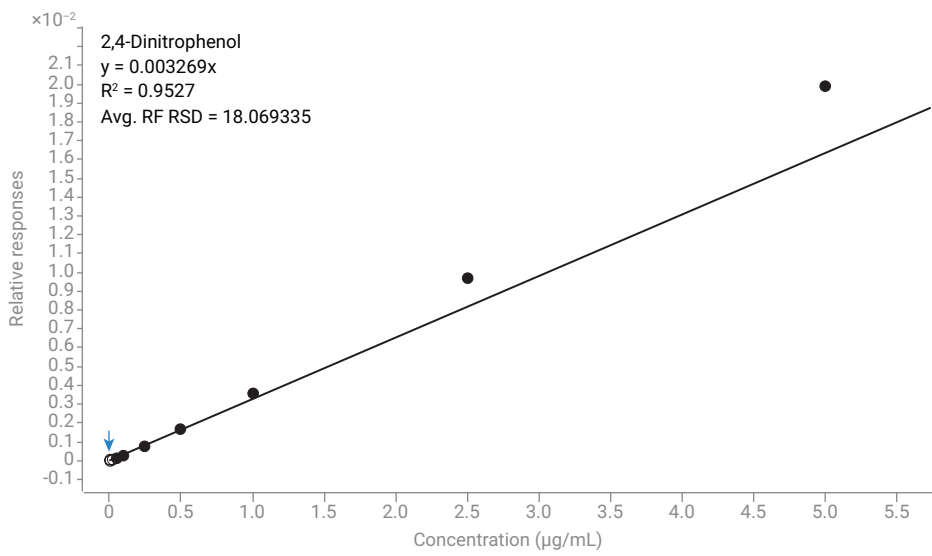

Figure 5. Avg RF calibration curve for challenging analyte 2,4-dinitrophenol 0.05 to 5 µg/mL. Avg. RF RSD = 18.07. Calibration points 1, 2, 3, and 11 are excluded.

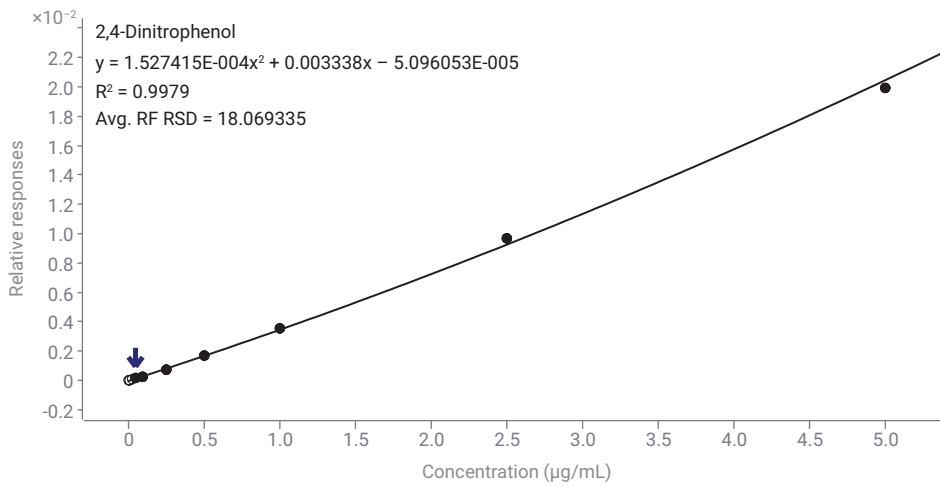

Figure 6. Alternate calibration curve for 2,4-dinitrophenol with a quadratic curve fit 0.05 to 5 µg/mL. $R^2 = 0.9979$. Calibration points 1, 2, 3, and 11 are excluded.

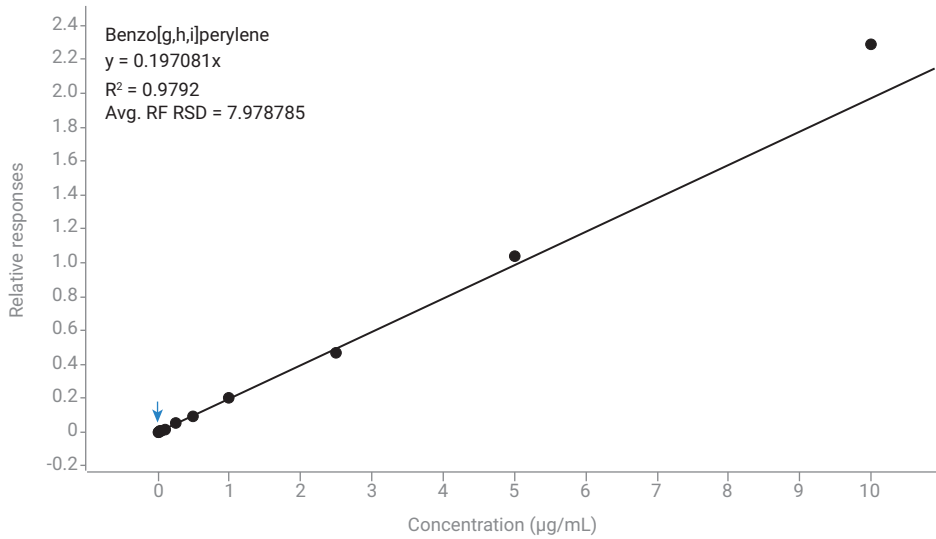

Figure 7. Avg RF calibration curve for benzo[g,h,i]perylene 0.005 to 10 $\mu\text{g/mL}$. Avg RF RSD = 7.98.

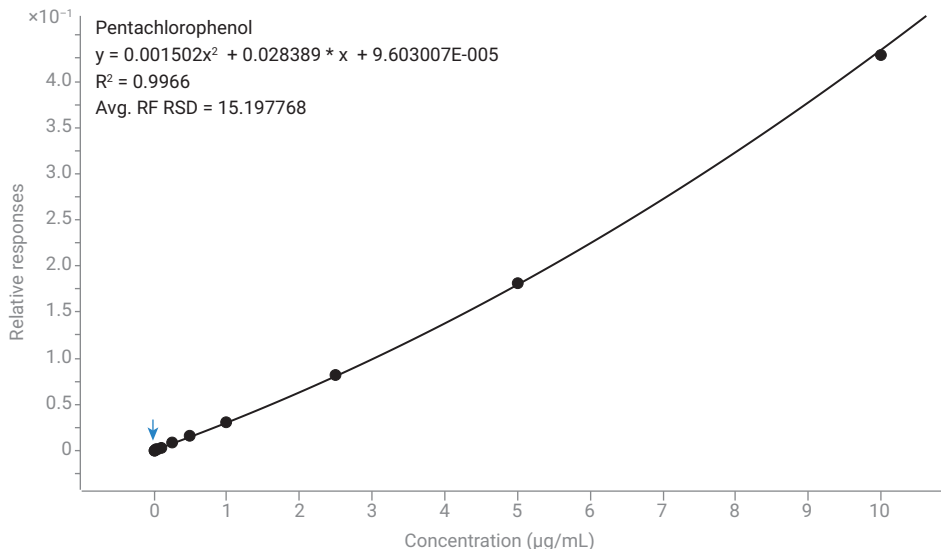

Figure 8. Calibration curve for pentachlorophenol 0.01 to 10 $\mu\text{g/mL}$. $R^2 = 0.9966$. Calibration point 1 excluded.

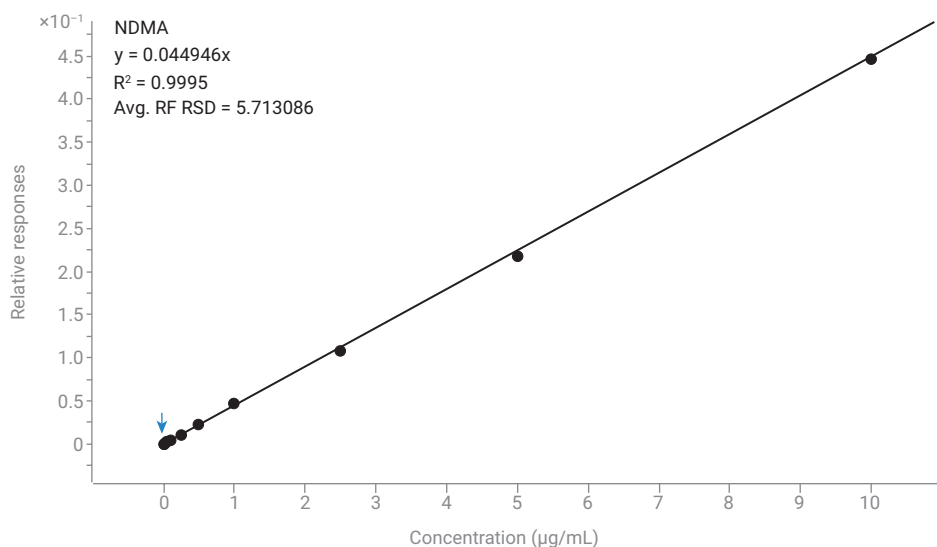

Figure 9. Calibration curve for NDMA. 0.01 to 10 µg/mL. Avg. RF RSD = 5.71. Calibration point 1 excluded.

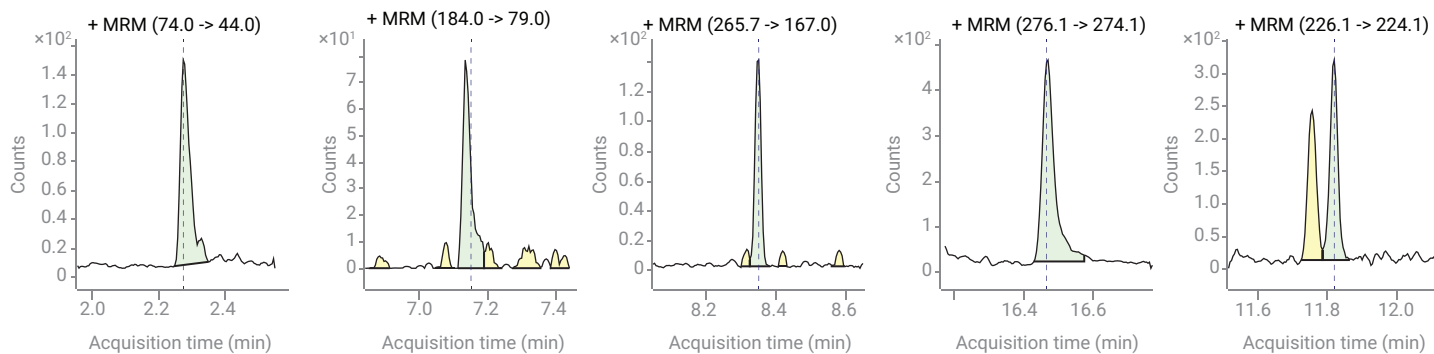

Figure 10. NDMA 0.01 µg/mL, 2,4-dinitrophenol 0.05 µg/mL, PCP 0.01 µg/mL, benzo[g,h,i]perylene 0.005 µg/mL, and chrysene 0.005 µg/mL.

Conclusion

A sensitive method for analysis of SVOCs has been developed that also demonstrates an extended dynamic range. Many analytes were shown to have a wide working calibration range over more than three orders of magnitude from 0.005 to 10 µg/mL. The collected data were evaluated with the quality criteria outlined in EPA 8270E.

GC/TQ offers significant advantages over the single quadrupole GC/MSD system in the analysis of SVOCs:

- High selectivity results in faster batch review by reducing the complexity of the data due to elimination of matrix interferences.
- Increased sensitivity opens the door for reduced sample sizes and smaller extraction volumes, which may:
 - Reduce waste while improving sustainability
 - Decrease costs associated with sample transport, solvent usage, and waste disposal
- Dynamic MRM mode generally reduces the number of individual MRM transitions during each MS scan. This improves instrument performance and makes adding and removing analytes from the method easy.
- The manufacturer recommended tune protocol simplifies tuning verification on the GC/TQ.

Key techniques for SVOC analysis by GC/MS which can improve results are

- Retention time locking ensures exact retention time fidelity even after column trimming which:
 - Eliminates the need to manually adjust retention times after maintenance
 - Makes data interchangeable across multiple instruments and multiple laboratories
- A pulsed split injection can enhance sensitivity over a standard split injection while maintaining a wide dynamic range.
- A 9 mm extractor lens gives outstanding linearity for all compounds while affording excellent sensitivity for many difficult analytes.

References

1. Churley, M. *et al.* A Fast Method for EPA 8270 in MRM Mode Using the 7000 Series Triple Quadrupole GC/MS. *Agilent Technologies application note*, publication number 5991-0694EN, **2019**.
2. M. Churley, *et al.*, EPA 8270 Re-Optimized for Widest Calibration Range on the 5977 Inert Plus GC/MSD. *Agilent Technologies application note*, publication number 5994-0349EN, **2018**.
3. Anderson, Kim A. *et al.* Modified ion source triple quadrupole mass spectrometer gas chromatograph for polycyclic aromatic hydrocarbon analyses. *J. Chromatog. A* **2015**, 1419, 89–98. doi:10.1016/j.chroma.2015.09.054
4. Stone, P. *et al.* New Dynamic MRM Mode Improves Data Quality and Triple Quad Quantification in Complex Analyses. *Agilent Technologies technical overview*, publication number 5990-3595, **2009**.
5. Semivolatile Organic Compounds by Gas Chromatography/Mass Spectrometry (GC/MS); Method 8270E Sections 1.4.7, 11.3.1.2, and 11.6.1.4; United States Environmental Protection Agency, Revision 4, June **2018**.

Disclaimer

Although reference is made to EPA documents for review of the data, the contents of this publication have not been subjected to EPA review and the opinions of the authors do not reflect EPA policy.

Appendix

A List of calibrated compounds and transitions is shown in the following table.

Compound Name	CAS No.	Retention Time (min)	Precursor Ion	Product Ion	Left RT Delta	Right RT Delta	CE
NDMA	62-75-9	2.25	74	44	0.3	0.3	6
NDMA	62-75-9	2.25	74	42	0.3	0.3	14
Pyridine	110-86-1	2.4	79	52	0.3	0.5	25
Pyridine	110-86-1	2.4	79	51	0.3	0.5	25
Phenol	108-95-2	3.92	94	66.1	0.3	0.3	15
Phenol	108-95-2	3.92	94	65.1	0.3	0.3	20
Aniline	62-53-3	3.96	93	66	0.3	0.3	10
Aniline	62-53-3	3.96	92	65	0.3	0.3	10
bis(2-Chloroethyl)ether	111-44-4	4.01	95.1	65	0.3	0.3	5
bis(2-Chloroethyl)ether	111-44-4	4.01	93.1	63	0.3	0.3	0
2-Chlorophenol	95-57-8	4.06	128	64	0.3	0.3	30
2-Chlorophenol	95-57-8	4.06	128	63	0.3	0.3	15
1,3-Dichlorobenzene	541-73-1	4.2	146	111	0.3	0.3	15
1,3-Dichlorobenzene	541-73-1	4.2	146	75	0.3	0.3	30
1,4-Dichlorobenzene-d4	3855-82-1	4.25	150	115	0.2	0.2	15
1,4-Dichlorobenzene-d4	3855-82-1	4.25	150	78	0.2	0.2	30
1,4-Dichlorobenzene	106-46-7	4.27	146	111	0.3	0.3	15
1,4-Dichlorobenzene	106-46-7	4.27	146	75	0.3	0.3	30
Benzyl alcohol	100-51-6	4.35	108	79	0.3	0.3	15
Benzyl alcohol	100-51-6	4.35	107	79	0.3	0.3	5
1,2-Dichlorobenzene	95-50-1	4.39	146	111	0.3	0.3	15
1,2-Dichlorobenzene	95-50-1	4.39	146	75	0.3	0.3	30
2-Methylphenol	95-48-7	4.44	108	107	0.3	0.3	15
2-Methylphenol	95-48-7	4.44	107	77	0.3	0.3	15
2,2'-oxybis[1-chloropropane]	108-60-1	4.47	121	77	0.3	0.3	5
2,2'-oxybis[1-chloropropane]	108-60-1	4.47	121	49	0.3	0.3	30
3+4-Methylphenol	108-39-4	4.57	108	107.1	0.3	0.3	15
3+4-Methylphenol	108-39-4	4.57	108	80	0.3	0.3	0
N-Nitrosodi- <i>n</i> -propylamine	621-64-7	4.58	113.1	71	0.3	0.3	10
N-Nitrosodi- <i>n</i> -propylamine	621-64-7	4.58	101	70	0.3	0.3	0
Hexachloroethane	67-72-1	4.69	200.9	165.9	0.3	0.3	15
Hexachloroethane	67-72-1	4.69	118.9	83.9	0.3	0.3	35
Nitrobenzene	98-95-3	4.74	123	77	0.3	0.3	10
Nitrobenzene	98-95-3	4.74	77	51	0.3	0.3	15
Isophorone	78-59-1	4.96	138	82	0.3	0.3	5
Isophorone	78-59-1	4.96	82	54	0.3	0.3	5
2-Nitrophenol	88-75-5	5.03	138.9	81	0.3	0.3	15
2-Nitrophenol	88-75-5	5.03	109	81	0.3	0.3	10
2,4-Dimethylphenol	105-67-9	5.06	121	107	0.3	0.3	10
2,4-Dimethylphenol	105-67-9	5.06	107.1	77.1	0.3	0.3	15
bis(2-Chloroethoxy)methane	111-91-1	5.15	95	65	0.3	0.3	5

Compound Name	CAS No.	Retention Time (min)	Precursor Ion	Product Ion	Left RT Delta	Right RT Delta	CE
bis(2-Chloroethoxy)methane	111-91-1	5.15	93	63	0.3	0.3	5
2,4-Dichlorophenol	120-83-2	5.25	163.9	63	0.3	0.3	30
2,4-Dichlorophenol	120-83-2	5.25	162	63	0.3	0.3	30
1,2,4-Trichlorobenzene	120-82-1	5.34	179.9	145	0.3	0.3	15
1,2,4-Trichlorobenzene	120-82-1	5.34	179.9	109	0.3	0.3	30
Naphthalene-d8	1146-65-2	5.39	136.1	108.1	0.2	0.2	20
Naphthalene-d8	1146-65-2	5.39	136.1	84.1	0.2	0.2	25
Naphthalene	91-20-3	5.41	128.1	102.1	0.3	0.3	20
Naphthalene	91-20-3	5.41	128.1	78.1	0.3	0.3	20
4-Chloroaniline	106-47-8	5.46	127	92	0.3	0.3	15
4-Chloroaniline	106-47-8	5.46	127	65	0.3	0.3	20
Hexachloro-1,3-butadiene	87-68-3	5.53	226.8	191.9	0.3	0.3	15
Hexachloro-1,3-butadiene	87-68-3	5.53	224.7	189.9	0.3	0.3	15
4-chloro-3-methylphenol	59-50-7	5.91	142	107	0.3	0.3	15
4-chloro-3-methylphenol	59-50-7	5.91	107	77	0.3	0.3	15
2-Methylnaphthalene	91-57-6	6.07	142	141	0.3	0.3	15
2-Methylnaphthalene	91-57-6	6.07	141	114.9	0.3	0.3	15
1-Methylnaphthalene	90-12-0	6.16	142	114.9	0.3	0.3	30
1-Methylnaphthalene	90-12-0	6.16	114.9	89	0.3	0.3	20
Hexachlorocyclopentadiene	77-47-4	6.22	236.7	143	0.3	0.3	20
Hexachlorocyclopentadiene	77-47-4	6.22	236.7	119	0.3	0.3	20
2,4,6-Trichlorophenol	88-06-2	6.34	197.8	97	0.3	0.3	25
2,4,6-Trichlorophenol	88-06-2	6.34	195.8	97	0.3	0.3	25
2,4,5-Trichlorophenol	95-95-4	6.37	197.8	97	0.3	0.3	30
2,4,5-Trichlorophenol	95-95-4	6.37	195.8	97	0.3	0.3	25
2-Chloronaphthalene	91-58-7	6.54	162	126.9	0.3	0.3	20
2-Chloronaphthalene	91-58-7	6.54	162	77	0.3	0.3	35
2-Nitroaniline	88-74-4	6.63	138	92	0.3	0.3	15
2-Nitroaniline	88-74-4	6.63	138	65	0.3	0.3	25
1,4-Dinitrobenzene	100-25-4	6.77	168	75	0.2	0.2	20
1,4-Dinitrobenzene	100-25-4	6.77	122	92	0.2	0.2	5
Dimethyl phthalate	131-11-3	6.82	163	92	0.3	0.3	30
Dimethyl phthalate	131-11-3	6.82	163	77	0.3	0.3	20
1,3-Dinitrobenzene	99-65-0	6.84	168	75	0.3	0.3	20
1,3-Dinitrobenzene	99-65-0	6.84	122	92	0.3	0.3	5
2,6-Dinitrotoluene	606-20-2	6.87	165	90.1	0.3	0.3	15
2,6-Dinitrotoluene	606-20-2	6.87	165	63	0.3	0.3	25
Acenaphthylene	208-96-8	6.94	151.9	102	0.3	0.3	30
Acenaphthylene	208-96-8	6.94	150.9	77	0.3	0.3	25
1,2-Dinitrobenzene	528-29-0	6.95	168	78	0.3	0.3	5
1,2-Dinitrobenzene	528-29-0	6.95	168	63	0.3	0.3	35
3-Nitroaniline	99-09-2	7.03	138	92	0.3	0.3	15
3-Nitroaniline	99-09-2	7.03	138	80	0.3	0.3	5
Acenaphthene-d10	15067-26-2	7.08	164.1	162.1	0.5	0.5	15
Acenaphthene-d10	15067-26-2	7.08	162.1	160.1	0.5	0.5	20
Acenaphthene	83-32-9	7.11	153.9	127	0.3	0.3	40
Acenaphthene	83-32-9	7.11	152.9	77	0.3	0.3	45

Compound Name	CAS No.	Retention Time (min)	Precursor Ion	Product Ion	Left RT Delta	Right RT Delta	CE
2,4-Dinitrophenol	51-28-5	7.14	184	107	0.3	0.3	25
2,4-Dinitrophenol	51-28-5	7.14	184	79	0.3	0.3	25
4-Nitrophenol	100-02-7	7.19	138.9	109	0.3	0.3	5
4-Nitrophenol	100-02-7	7.19	109	81	0.3	0.3	10
2,4-Dinitrotoluene	121-14-2	7.27	165	119	0.3	0.3	5
2,4-Dinitrotoluene	121-14-2	7.27	165	63	0.3	0.3	45
Dibenzofuran	132-64-9	7.29	167.9	139.1	0.3	0.3	25
Dibenzofuran	132-64-9	7.29	138.9	63	0.3	0.3	35
2,3,5,6-Tetrachlorophenol	935-95-5	7.36	232	167.9	0.2	0.2	15
2,3,5,6-Tetrachlorophenol	935-95-5	7.36	230	165.9	0.2	0.2	15
2,3,4,6-Tetrachlorophenol	58-90-2	7.4	231.9	167.9	0.3	0.3	15
2,3,4,6-Tetrachlorophenol	58-90-2	7.4	230	165.9	0.3	0.3	15
Diethyl phthalate	84-66-2	7.51	149	93	0.3	0.3	15
Diethyl phthalate	84-66-2	7.51	149	65	0.3	0.3	20
4-Chlorodiphenyl ether	7005-72-3	7.62	204	77	0.3	0.3	30
4-Chlorodiphenyl ether	7005-72-3	7.62	141.1	115.1	0.3	0.3	20
Fluorene	86-73-7	7.62	166	165.1	0.3	0.3	15
Fluorene	86-73-7	7.62	164.9	163.1	0.3	0.3	35
4-Nitroaniline	100-01-6	7.64	138	108.1	0.3	0.3	5
4-Nitroaniline	100-01-6	7.64	108	80	0.3	0.3	15
4,6-dinitro- <i>o</i> -cresol	534-52-1	7.66	198	167.9	0.3	0.3	5
4,6-dinitro- <i>o</i> -cresol	534-52-1	7.66	198	121	0.3	0.3	10
Diphenylamine	122-39-4	7.75	170	169.2	0.3	0.3	15
Diphenylamine	122-39-4	7.75	167	166.2	0.3	0.3	20
Azobenzene	103-33-3	7.79	105	77.1	0.3	0.3	5
Azobenzene	103-33-3	7.79	77	51	0.3	0.3	15
4-bromophenyl phenyl ether	101-55-3	8.1	250	141	0.3	0.3	20
4-bromophenyl phenyl ether	101-55-3	8.1	248	141	0.3	0.3	20
Hexachlorobenzene	118-74-1	8.16	283.7	213.8	0.3	0.3	30
Hexachlorobenzene	118-74-1	8.16	248.7	214	0.3	0.3	15
Pentachlorophenol	87-86-5	8.35	265.7	167	0.3	0.3	25
Pentachlorophenol	87-86-5	8.35	165	130	0.3	0.3	25
Phenanthrene-d10	1517-22-2	8.54	188.3	160.2	0.2	0.2	20
Phenanthrene-d10	1517-22-2	8.54	188.3	158.2	0.2	0.2	35
Phenanthrene	85-01-8	8.57	177.9	152	0.3	0.3	25
Phenanthrene	85-01-8	8.57	175.9	149.9	0.3	0.3	25
Anthracene	120-12-7	8.62	178.1	151	0.3	0.3	30
Anthracene	120-12-7	8.62	177.9	152	0.3	0.3	25
Carbazole	86-74-8	8.77	167	139	0.3	0.3	45
Carbazole	86-74-8	8.77	167	89	0.3	0.3	60
Di- <i>n</i> -butyl phthalate	84-74-2	9.13	149	121	0.3	0.3	15
Di- <i>n</i> -butyl phthalate	84-74-2	9.13	149	65	0.3	0.3	25
Fluoranthene	206-44-0	9.76	201.9	151.9	0.3	0.3	30
Fluoranthene	206-44-0	9.76	200.9	199.9	0.3	0.3	15
Pyrene	129-00-0	10.02	202.1	151	0.3	0.3	45
Pyrene	129-00-0	10.02	201.1	200	0.3	0.3	15

Compound Name	CAS No.	Retention Time (min)	Precursor Ion	Product Ion	Left RT Delta	Right RT Delta	CE
Butyl benzyl phthalate	85-68-7	10.9	149	65	0.3	0.3	25
Butyl benzyl phthalate	85-68-7	10.9	91	65	0.3	0.3	15
Benz[a]anthracene	56-55-3	11.75	228.1	226.1	0.3	0.3	30
Benz[a]anthracene	56-55-3	11.75	226.1	224.1	0.3	0.3	35
Chrysene-d12	1719-03-5	11.77	240.2	236.2	0.3	0.3	35
Chrysene-d12	1719-03-5	11.77	236.1	232.1	0.3	0.3	40
Chrysene	218-01-9	11.81	226.1	224.1	0.3	0.3	40
Chrysene	218-01-9	11.81	113.1	112.1	0.3	0.3	10
Bis(2-ethylhexyl) phthalate	117-81-7	11.9	167	149	0.3	0.3	5
Bis(2-ethylhexyl) phthalate	117-81-7	11.9	149	65	0.3	0.3	25
Di-n-octyl phthalate	117-84-0	13.29	149	93	0.3	0.3	20
Di-n-octyl phthalate	117-84-0	13.29	149	65	0.3	0.3	25
Benzo[b]fluoranthene	205-99-2	13.88	252.1	250.1	0.3	0.3	35
Benzo[b]fluoranthene	205-99-2	13.88	126	113.1	0.3	0.3	10
Benzo[k]fluoranthene	207-08-9	13.93	252.1	250.1	0.3	0.3	30
Benzo[k]fluoranthene	207-08-9	13.93	126.1	113.1	0.3	0.3	10
Benzo[a]pyrene	50-32-8	14.42	252.1	250.1	0.3	0.3	35
Benzo[a]pyrene	50-32-8	14.42	125	124.1	0.3	0.3	10
Perylene-d12	1520-96-3	14.5	264.2	260.1	0.3	0.3	35
Perylene-d12	1520-96-3	14.5	260.1	256.1	0.3	0.3	40
Indeno[1,2,3-cd]pyrene	193-39-5	16.05	276.1	274.1	0.3	0.3	40
Indeno[1,2,3-cd]pyrene	193-39-5	16.05	137	136	0.3	0.3	15
Dibenz[a,h]anthracene	53-70-3	16.1	278.1	276.1	0.3	0.3	35
Dibenz[a,h]anthracene	53-70-3	16.1	125	124	0.3	0.3	10
Benzo[g,h,i]perylene	191-24-2	16.47	276.1	274.1	0.3	0.3	45
Benzo[g,h,i]perylene	191-24-2	16.47	138	137	0.3	0.3	15

Consumables	Part Number
Sample Containment	
Vials, screw top, amber, deactivated, 2 mL, 100/pk	5183-2072
Cap, screw, PTFE/silicone septa, 100/pk	5040-4681
Vial inserts, 250 µL, deactivated, 100/pk	5181-8872
Instrument Supplies	
Syringe, Blue Line, 10 µL, fixed needle, 23-26s/42/cone, 6/pk	G4513-80200
Inlet septa, Advanced Green, nonstick, 11 mm, 50/pk	5183-4759
Inlet liner, Ultra Inert, split, low pressure drop, glass wool	5190-2295
GC inlet seal, gold plated, with washer, Ultra Inert, 10/pk	5190-6145
Lens, extraction, 9 mm	G3870-20449
Separation	
J&W DB-8270D Ultra Inert GC column, 30 m × 0.25 mm, 0.25 µm	122-9732

www.agilent.com

DE50589665

This information is subject to change without notice.

© Agilent Technologies, Inc. 2022
 Printed in the USA, September 20, 2022
 5994-4964EN



Five Keys to Unlock Maximum Performance in the Analysis of Over 200 Pesticides in Challenging Food Matrices by GC/MS/MS



Authors

Anastasia A. Andrianova and
Limian Zhao
Agilent Technologies, Inc.

Abstract

This application note describes five best practices to enhance analytical performance in the analysis of over 200 pesticides in challenging matrices including spinach, walnut, and cayenne pepper. The novel Agilent Captiva EMR passthrough cleanup procedure following the Agilent QuEChERS extraction enabled a cleaner matrix background. The cleanup and extraction reduced matrix interferences with target analytes and extended the maintenance-free operation time of the instrument. Calibration performance was demonstrated over a wide dynamic range to over four orders of magnitude. It was shown that the Agilent 8890/7000E triple quadrupole GC/MS system achieved excellent linearity over a concentration range of 0.1 to 5,000 ppb. The Agilent 8890/7010C triple quadrupole GC/MS system demonstrated superior sensitivity yielding a higher signal-to-noise ratio at lower concentrations.

Introduction

The global agriculture industry uses over a thousand different pesticides in the production of food. Producers require pesticides to meet the increasing demand for reasonably priced food. This growing demand has increased the use of pesticides and encouraged problematic agricultural practices that have elevated risks in the food supply and the environment. Concerns about trace level chemical pollutants in food are driving the demand for more rapid and reliable methods for the identification and quantitation of chemical residues. The **Agilent 8890/7000E** and **8890/7010C** triple quadrupole GC/MS systems (GC/TQ) are ideally suited to meet this need.

The US Environmental Protection Agency (EPA) sets tolerances as part of the food safety equation.¹ The tolerance corresponds to the maximum residue limit (MRL), which is the maximal level of pesticide residue allowed to remain in or on the treated food commodity. The MRLs may vary over a broad concentration range depending on different pesticides and food commodities. For example, the MRLs established for 68 pesticides regulated in spinach vary from 10 ppb for fludioxonil to 60,000 ppb for boscalid.² This range of limits presents a challenge for the analysis, requiring both high sensitivity and the ability to calibrate over a wide dynamic range.

Five key components of successful pesticide analysis discussed in this application note are:

- 1 Effective sample extraction and matrix cleanup, which allow for minimal matrix background and interferences while maintaining high pesticide recoveries. Also, a robust analytical method that achieves the required method performance while increasing maintenance-free uptime.

- 2 Evaluation of the matrix in full scan data acquisition mode to ensure the most efficient performance, especially with the high efficiency source (HES).
- 3 Midcolumn backflushing to extend maintenance-free operation of the system. This technique minimizes column trimming and source cleaning while also allowing reduced analysis time.
- 4 A leak-free GC/TQ system enables extended GC column life and facilitates maintenance-free consistent and reliable MS performance.
- 5 Use of the temperature-programmed Agilent multimode inlet (MMI) with a 2 mm dimpled liner (no glass wool) to ensure efficient volatilization of even the most thermally labile compounds.

This application note demonstrates the analysis of over 200 pesticides in three challenging matrices, including a high chlorophyll fresh matrix spinach, a complex dry matrix cayenne pepper, and an oily dry matrix walnut. The achieved wide dynamic ranges with high method sensitivity enabled accurate quantification of pesticides in these matrices, at their MRLs.

Matrix-matched calibrations with $R^2 > 0.99$ over a dynamic range as wide as 0.1 to 5,000 ppb were achieved with the 7000E GC/TQ and 0.1 to 1,000 ppb with the 7010C GC/TQ. The 7010C GC/TQ equipped with the HES enabled superior sensitivity yielding high signal-to-noise ratio even at low concentrations and allowed for accurate quantification at concentrations below 0.1 ppb. However, this was not required in this work as the MRLs for pesticides regulated in the commodities of interest did not require sub-0.1 ppb quantification.

Experimental

GC/TQ analysis

The 8890/7000E and 8890/7010C GC/TQ systems (Figure 1A) were used and configured to achieve the best performance over a wide calibration range. This calibration range encompassed the varying MRLs for pesticides regulated in the analyzed commodities. The GC was configured with the Agilent 7693A automatic liquid sampler (ALS) and 150-position tray. The system used a multimode inlet (MMI) operated in temperature-programmed splitless injection mode. Midcolumn backflush capability was provided by the Agilent Purged Ultimate Union (PUU) installed between two identical 15 m columns, and the 8890 pneumatic switching device (PSD) module (Figure 1B). The instrument operating parameters are listed in Table 1.

Data were acquired in dynamic MRM (dMRM) mode, which enables the capability for large multi-analyte assays and to accurately quantitate narrow peaks by an automated and most-efficient dwell time distribution. The dMRM capability enabled a successful analysis for a large panel of 203 pesticide with 614 total MRM transitions with up to 52 concurrent MRMs (Figure 2). Furthermore, dMRM enables the analyst to add and remove additional analytes with ease. The acquisition method was retention time-locked to match the retention times in the Agilent MassHunter Pesticide & Environmental Pollutant MRM Database (P&EP 4), which was used to seamlessly create the MS method. The use of P&EP 4 increased the ease and speed of setting up a targeted dMRM method. The acquisition method was retention time locked to the P&EP library.

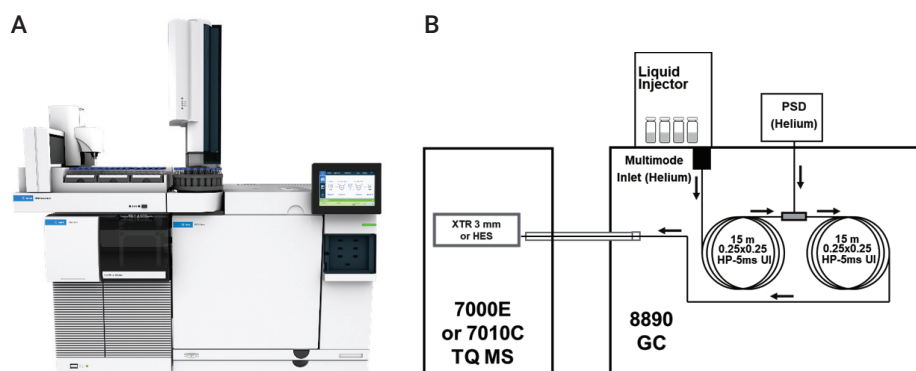

Figure 1. The Agilent 8890/7000E and 8890/7010C GC/TQ system (A) and system configuration (B).

Table 1. Agilent 8890/7000E and 8890/7010C gas chromatograph and mass spectrometer conditions for pesticide analysis.

GC		Column 1		MSD	
Agilent 8890 with fast oven, auto injector, and tray		Type	Agilent HP-5ms UI (p/n 19091S-431UI-KEY)	Model	Agilent 7000E or 7010C
Inlet	Multimode inlet (MMI)	Length	15 m	Source	Inert Extractor Source with a 3 mm lens or HES
Mode	Splitless	Diameter	0.25 mm	Vacuum Pump	Performance turbo
Purge Flow to Split Vent	60 mL/min at 0.75 min	Film Thickness	0.25 µm	Tune File	Atunes.eiex.jtune.xml or Atunes.eihs.jtune.xml
Septum Purge Flow	3 mL/min	Control Mode	Constant flow	Solvent Delay	3 min
Septum Purge Flow Mode	Switched	Flow	1.016 mL/min	Quad Temperature (MS1 and MS2)	150 °C
Injection Volume	1.0 µL	Inlet Connection	Multimode inlet (MMI)	Source Temperature	280 °C
Injection Type	Standard	Outlet Connection	PSD (PUU)	Mode	dMRM or Scan
L1 Airgap	0.2 µL	PSD Purge Flow	5 mL/min	He Quench Gas	2.25 mL/min
Gas Saver	On at 30 mL/min after 3 min	Post Run Flow (Backflushing)	-7.873	N ₂ Collision Gas	1.5 mL/min
Inlet Temperature	60 °C for 0.1 min, then to 280 °C at 600 °C/min	Column 2		MRM Statistics	
Post Run Inlet Temperature	310 °C	Type	Agilent HP-5ms UI (p/n 19091S-431UI-KEY)	Total MRMs (dMRM Mode)	614
Post Run Total Flow	25 mL/min	Length	15 m	Minimum Dwell Time	6.85 ms
Carrier Gas	Helium	Diameter	0.25 mm	Minimum Cycle Time	69.8 ms
Inlet Liner	Agilent Ultra Inert 2 mm dimpled liner (p/n 5190-2297)	Film Thickness	0.25 µm	Maximum Concurrent MRMs	52
Oven		Control Mode	Constant flow	EM Voltage Gain Mode	10
Initial Oven Temperature	60 °C	Flow	1.216 mL/min	Scan Parameters	
Initial Oven Hold	1 min	Inlet Connection	PSD (PUU)	Scan Type	MS1 Scan
Ramp Rate 1	40 °C/min	Outlet Connection	MSD	Scan Range	45 to 450 m/z
Final Temp 1	170 °C	Post Run Flow (Backflushing)	8.202	Scan Time (ms)	220
Final Hold 1	0 min			Step Size	0.1 amu
Ramp Rate 2	10 °C/min			Threshold	0
Final Temp 2	310 °C			EM Voltage Gain Mode	1
Final Hold 2	2.25 min				
Total Run Time	20 min				
Post Run Time	1.5 min				
Equilibration Time	0.25 min				

Full scan data acquisition mode was used for the preliminary screening of the matrix extract. This screening was used to evaluate the in-source loading and for monitoring the efficiency of the sample cleanup.

Agilent MassHunter Workstation revisions 10.1 and 10.2 including MassHunter Acquisition software for GC/MS systems 10.2, MassHunter Quantitative 10.1, and MassHunter Qualitative 10 packages were used in this work.

Calibration performance was evaluated using a series of matrix-matched calibration standards ranging from 0.1 to 5,000 ppb, including 0.1, 0.5, 1, 5, 10, 50, 100, 250, 500, 1,000, and 5,000 ppb. The standard α -BHC- d_6 at a final concentration of 20 ppb in vial was used as the internal standard for quantitation of the target pesticides. A linear or quadratic regression fit with a weighting factor of $1/x$ was applied to all calibration curves.

Sample preparation

A sample preparation workflow chart is shown in Figure 3. The sample preparation included two major steps: sample extraction by traditional QuEChERS extraction, followed with Captiva EMR pass-through clean up. Different Captiva EMR products were used for different matrices based on different matrix challenges. A Captiva EMR-HCF cartridge was used for high-chlorophyll fresh matrix spinach. Captiva EMR-LPD was used for the low pigmented but oily dry matrix walnut. Captiva EMR-GPD was used for a very challenging dry matrix cayenne pepper. The new sample preparation workflow demonstrates a simplified procedure with improvement on both sample matrix removal and targets quantitation data quality.

As shown in Figure 3, samples were first extracted by the traditional QuEChERS EN extraction kit (part number 5892-5650). For fresh spinach, 10 g of homogenized spinach sample was used for extraction. For walnut, 5 g of walnut powder was used, followed with the addition of 10 mL of water and 10 minutes of vortexing. For cayenne pepper, 2 g of cayenne pepper powder was used, followed with the addition of 10 mL water and 10 minutes vortexing. The 10 mL of ACN with 1% acetic acid was then added for extraction, followed with QuEChERS EN extraction. After extraction, 3 mL of crude extract or with 10% of water mixture was transferred to Captiva EMR cartridges for pass-through cleanup.

The following cartridges were used: Captiva Enhanced Matrix Removal High Chlorophyll Fresh, with NH_2 , (Captiva EMR-HCF1, part number 5610-2088) for spinach, the Captiva Enhanced Matrix Removal Low Pigment Dry (Captiva EMR-LPD, part number 5610-2092) for walnut, and the Captiva Enhanced Matrix Removal General Pigmented Dry (Captiva EMR-GPD, part number 5610-2091) for cayenne pepper. The sample eluent was collected and further dried by anhydrous $MgSO_4$, (part number 5982-0102) and samples were then ready for GC/TQ analysis. The positive pressure manifold 48 processor (PPM-48, part number 5191-4101) was used for Captiva EMR pass-through clean up processing.

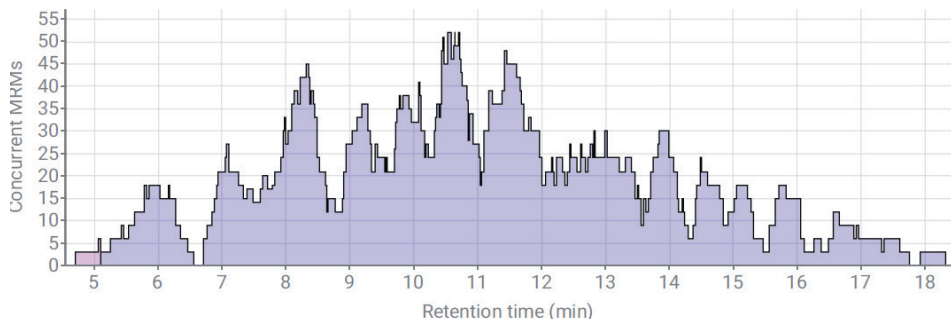

Figure 2. The distribution of 614 MRM transitions with up to 52 concurrent MRMs monitored during the analysis enabling most efficient dwell time distribution.

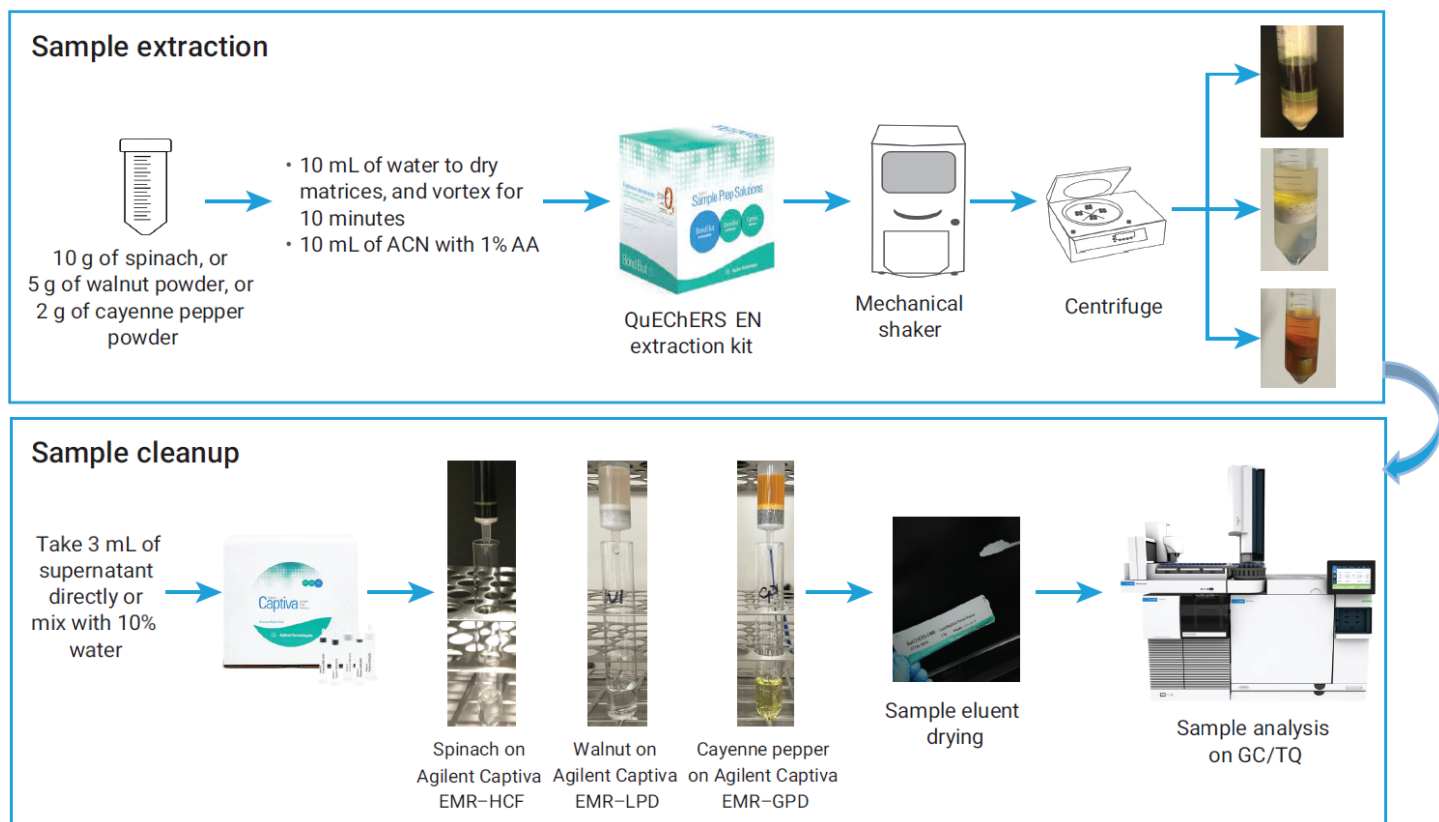

Figure 3. Sample preparation flowchart including traditional QuEChERS extraction, followed with Captiva EMR pass-through cleanup.

Results and discussion

Robust pesticide analysis that supports a high-throughput workflow must provide an extended maintenance-free operation with minimal downtime. The workflow must also meet the required sensitivity that can be at sub-ppb level. It must also enable calibration performance over a wide dynamic range that would encompass the MRLs for the compounds monitored in the commodity, which often vary over a wide dynamic range. The five key strategies outlined in this application note allowed achieving limits of quantification (LOQs) of up to 0.1 ppb while maintaining the calibration performance over a range up to 5,000 ppb for the 7000E and 1,000 ppb for the 7010C. In addition, the strategies would enable minimal instrument downtime limited to liner and septum replacement every ~100 injections.

The work presented in this application note and the system robustness study with 700 consecutive injections described elsewhere³ resulted in over 1,000 injections of complex matrix extracts including spinach, walnut, and cayenne pepper. During this time, there was no need to perform TQ MS tuning, source cleaning, or GC column trimming.

Sample preparation

Efficient sample extraction and matrix cleanup are the keys to successful pesticide analysis. Analysis of crude QuEChERS extracts, especially of complex pigmented and oily matrices, can significantly increase the need for liner replacement, inlet cleaning, GC column trimming, and MS source cleaning. Such maintenance procedures decrease throughput of the analysis.

Performing an efficient matrix cleanup following QuEChERS extraction reduces in-source matrix loading and interferences with targets, while improving signal-to-noise ratio, accuracy, and reproducibility for target pesticides. Captiva EMR passthrough clean up following the traditional QuEChERS extraction was used in this work. The new sample cleanup protocol is a simplified procedure that demonstrates an improvement on both sample matrix removal and targets overall recovery and reproducibility. As shown in Figure 4, the abundance of TIC signal in full scan data acquisition mode was noticeably reduced for spinach, walnut, and cayenne pepper extracts after clean up when comparing the crude extracts before cleanup.

Matrix screening in full scan data acquisition mode

Performing sample screening in full scan data acquisition mode facilitates the evaluation of in-source matrix loading. Every MS source has a limitation on the amount of material present in the source, at any point of time, to maintain the optimal performance. Quantitation accuracy of the analysis can be significantly compromised if the source is overloaded with matrix. Therefore, it is essential to analyze matrix in full scan mode to evaluate TIC and maintain the optimal GC/TQ performance. The abundance of TIC in full scan mode is recommended not to exceed 7×10^7 counts when analyzing with an EM gain set to 1. Out of the three analyzed matrices, cayenne pepper featured the highest matrix background, although noticeably reduced after the clean up procedure. This evaluation revealed that pesticides that elute between 11 and 12.5 minutes were expected to have sacrificed performance in the cayenne pepper matrix when evaluating sensitivity and the dynamic range. For example, Endosulfan I eluted at 11.273 minutes, and could be quantitated only starting at 5 ppb in the cayenne pepper matrix with both 7000E and 7010C, while spinach and walnut matrices had significantly lower matrix levels coeluting with Endosulfan I, with 0.1 ppb LOQ observed. Best practices on using the Agilent GC/TQ system in full scan data acquisition mode can be found in the application note 5994-3859EN.⁴

Some of the practices that can be employed to lower the matrix background include adequate sample cleanup, sample dilution, and smaller injection volume. The latter two approaches often result in better LOQs, especially with the HES-equipped 7010C GC/TQ system.

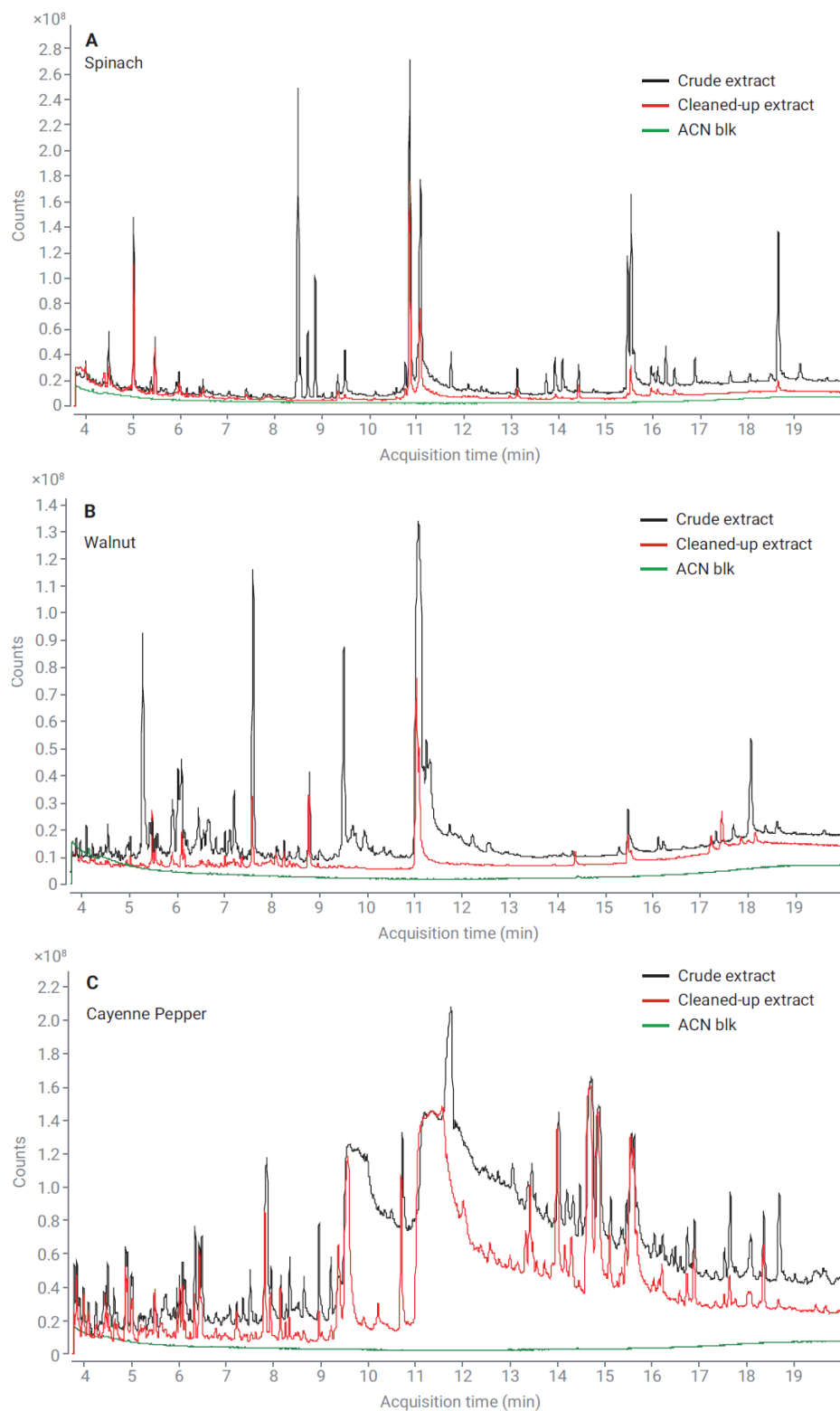

Figure 4. Scan TIC of the spinach (A), walnut (B), and cayenne pepper (C) extracts. The red trace corresponds to matrix sample with Captiva EMR cleanup, and the black trace corresponds to matrix sample without clean up. The green trace corresponds to the acetonitrile solvent blank.

Midcolumn backflushing

The use of the midcolumn backflushing configuration allows the analyst to limit the analysis time to the retention time of the last-eluting compound of interest. Challenging matrices, especially the oily ones, such as walnut, are rich in high-boiling components, with long retention times. These retention times often exceed that for the target pesticides. A common way to avoid ghost-peaks in the subsequent runs was to use an extended column bake-out after the last target analyte eluted from the column. However, this approach has several disadvantages including the deposition of high-boilers and GC column stationary phase into the EI source, contamination of the head of the GC column, a decrease of the column lifetime, and a longer cycle time due to the extended bake-out.

Midcolumn backflush allows the elution of the high boiling matrix components from the column without the sacrifices encountered with the bake-out approach. Midcolumn backflushing is a technique in which the carrier gas flow is reversed after the last analyte has exited the column. After the MS data are collected, the oven is held at the final temperature in post run mode, and the carrier gas flow through the first column is reversed. This reversed flow carries any high boilers that were in the column at the end of data collection. The high boilers are carried out of the head of the column and into the split vent trap (Figure 5A). The ability to reverse the flow is provided by the Agilent Purged Ultimate Union (PUU). The PUU is a tee that is inserted, in this case, between two identical 15 m columns.

During the analysis, a small makeup flow of carrier gas from the 8890 pneumatic switching device (PSD) module is used to sweep the connection. During backflushing, the makeup flow from the PSD is raised to a much higher value, sweeping high boilers backward out of the first column while simultaneously

providing forward flow in the second column. For the configuration in this application, the backflushing time was 1.5 minutes. More details about using PSD for backflushing in the 8890 GC system can be found in the application note 5994-0550EN.⁵

The chromatograms shown in Figure 5B illustrate the effectiveness of the backflush technique in reducing cycle time sample carryover. The cycle time was reduced by 50% and the columns did not have to be exposed to the higher bake-out temperatures for an extended time. Using backflush, excess column bleed and heavy residues are not introduced into the MSD, thereby reducing ion source contamination.

In addition, the midcolumn backflushing configuration provides a significant time saving benefit when coupled with the MMI inlet. Maintenance procedures, such as septum and liner change, and column trimming can be performed without the need to cool down MS transfer line and source. When the septum is removed, the PSD provides the carrier gas flowing backward through column 1. The PSD also prevents air from entering the GC columns and the MS. MMI fast cooling capability enables more time savings. As a result, liner and septum replacement, which are the most common maintenance procedures, can be performed in a few minutes.

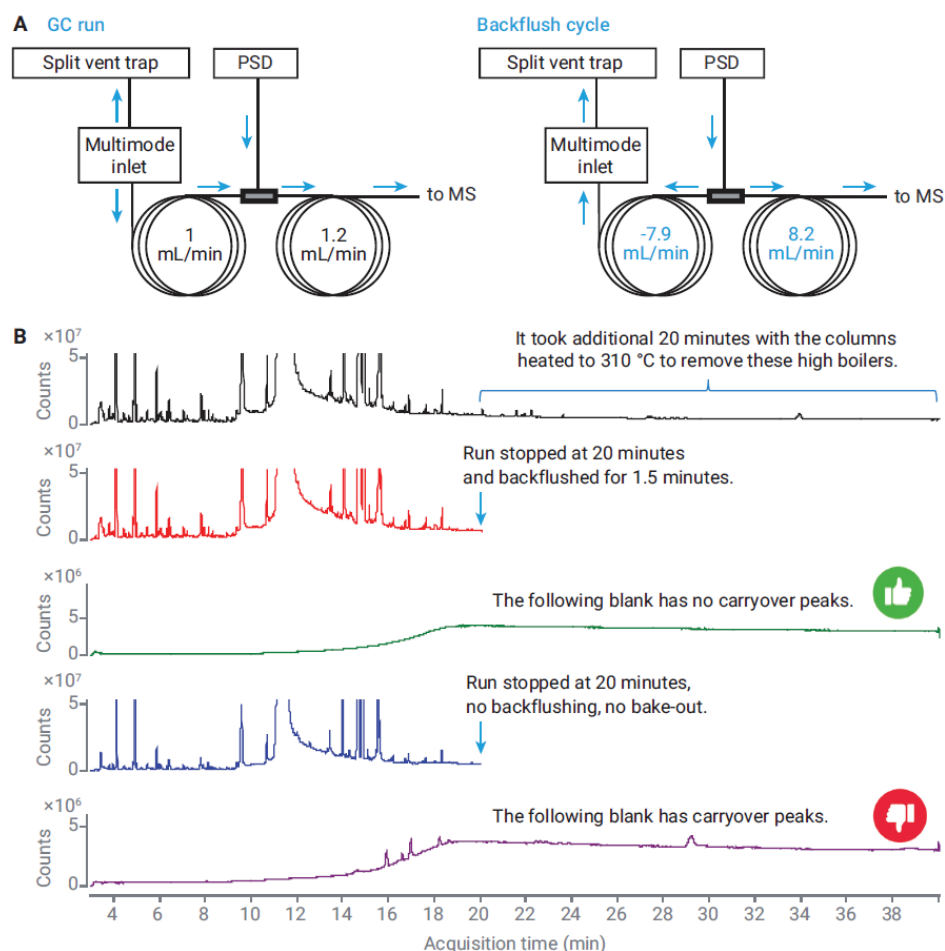

Figure 5. Midcolumn backflush configuration and gas flow during the GC run and the backflush cycle (A); TIC Scan chromatograms of a cayenne pepper extract followed by the analysis of an instrument blank with column bake-out, with backflush and without backflush or bake-out (B).

Leak-free GC/TQ system

Maintaining the GC/MS system leak-free is essential for the long-term performance of the instrument. Undesired leaks reduce the GC column lifetime and lead to oxidation of the EI source degrading its performance. The tools that enable tight connection make installation easy and reproducible and include the self-tightening collared column nuts for GC (Figures 6A and 6B part numbers G3440-81011 and G3440-81013) and CFT gold-plated flexible metal ferrules (Figure 6C, part number G2855-28501).

The self-tightening collared column nuts have an innovative spring-driven piston. The piston continuously presses against the short graphite/polyimide ferrule, maintaining a leak-free seal even after hundreds of temperature cycles of the oven. The addition of the collar makes column installation into the GC inlet and MS transfer line easy and reduces the possibility of variation. The locking collar allows locking the column in place, for accurate and repeatable installation results, time after time. The simplicity of the column installation process with the self-tightening collared column nuts is demonstrated in these videos.^{6,7} When MS source maintenance is not required, the collared nut in combination with the column installation tool (part number G1099-20030) allows installation of the column into the MS without opening the side door.

Gold-plated flexible metal ferrules are inert and provide exceptionally reliable sealing. They prevent formation of microleaks at the CFT (PUU) connection and allow for maintaining high sensitivity of the GC/TQ.



Figure 6. Self-tightening collared column nuts for the inlet (A) and MS transfer line connection (B) and gold-plated flexible metal ferrules (C).

To confirm the leak-free status of the system, the air/water check, or autotune report, are often evaluated to determine how much of a leak is detected by the MS. However, this approach does not help to identify the source of the leak. Additionally, it may miss microleaks like those that may be present at user connections.

The novel leak test functionality is available with the 7000E and 7010C GC/TQ with MassHunter Data Acquisition 10.2 and above. The leak test can identify the source, and monitor the magnitude, of the leak. The tool monitors up to 10 user-specified ions (Figure 7A), including ions from a leak testing gas such as air duster (m/z 69 and 83, Figure 7B). The tool plots the corresponding chromatograms including EICs and TIC (Figure 7C).

Optimized injection with the temperature-programmable multimode inlet (MMI)

Efficiently volatilizing the sample in the GC inlet is an essential component of a successful GC/MS analysis. Some pesticides, such as captafol, captan, dicofol, folpet, and deltamethrin, are known to be thermally labile. They are anticipated to suffer thermal degradation during injection. Starting the injection at lower temperature of 60 °C and ramping up to 280 °C allows for volatilizing all the target analytes while maintaining their chemical integrity upon introduction to the GC column. Moreover, the ability to program the inlet temperature allows heating up the inlet further to 310 °C during the post run while backflushing. This heating enables the system to bake-out any matrix residue that may remain in the inlet.

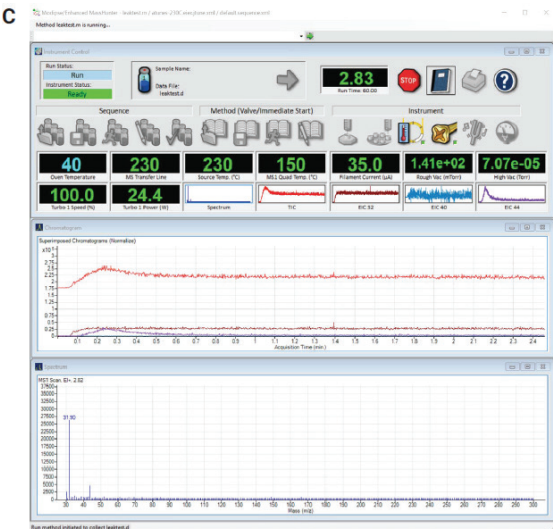
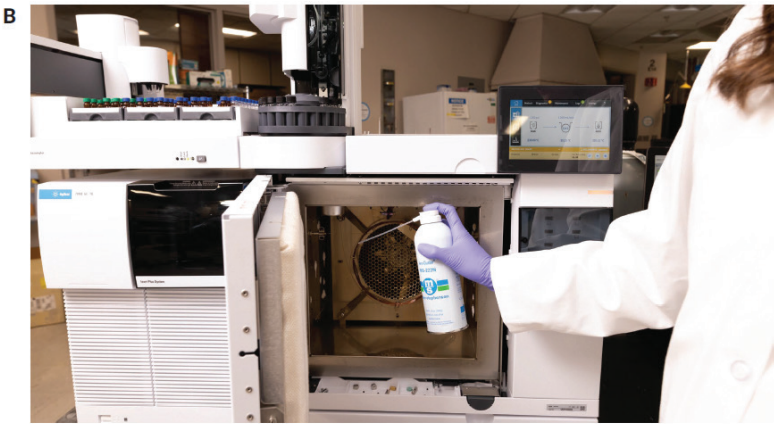
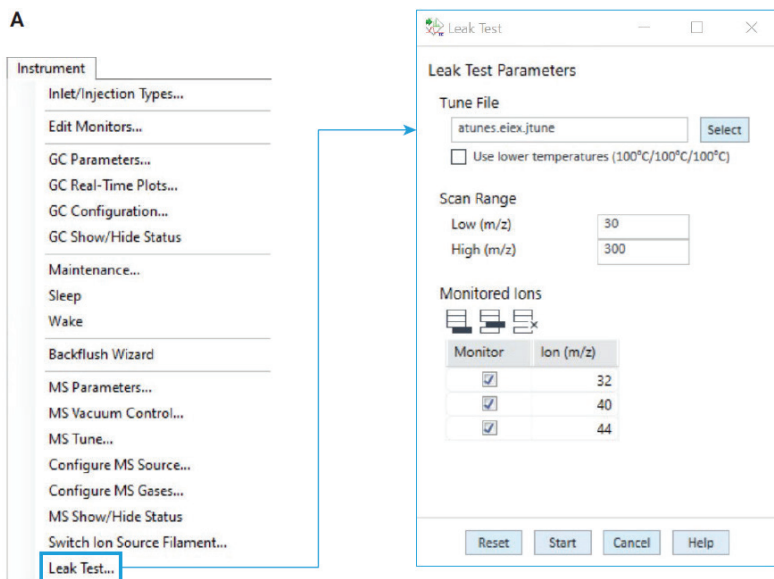

Figure 7. The novel leak testing tool that enables monitoring of the user-specified ions to identify the source and the amount of leak.

The combination of temperature-programmable injection with an Ultra Inert 2 mm dimpled liner resulted in high sensitivity even for challenging pesticides like deltamethrin in a complex walnut matrix. Figure 8A demonstrates the response of deltamethrin, a pesticide with an established MRL in walnut, at 0.5 ppb with the 7000E and the 7010C GC/TQ.

is equipped with the HES that yields a higher sensitivity resulting in higher signal-to-noise ratio (S/N).

Pentachloronitrobenzene is a pesticide that is commonly analyzed by GC/MS in various food commodities as it has established MRLs in many vegetables and fruits (Crop Group 8 Fruiting Vegetables Group), peanuts, and soybean seeds that vary from 20 ppb

to 1 ppm.⁸ Pentachloronitrobenzene presents a challenge for LC/MS analysis, so GC/MS analysis is the technique of choice. Figure 8B demonstrates the chromatograms for a selective MRM transition for pentachloronitrobenzene in a walnut extract with the 7000E and the 7010C.

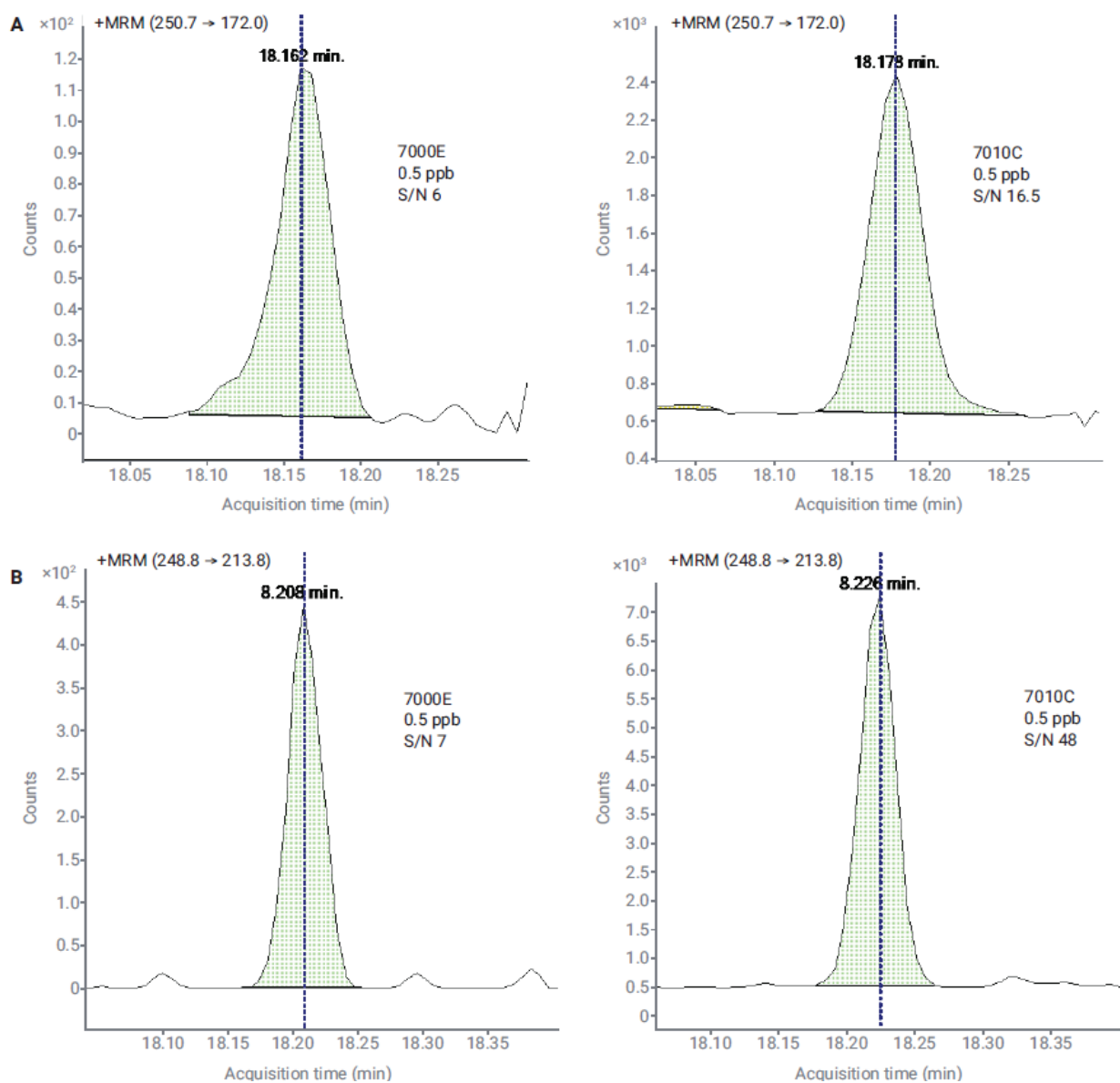

Figure 8. MRM chromatograms for deltamethrin (A) and pentachloronitrobenzene (B) at 0.5 ppb in walnut extract analyzed with the 7000E and the 7010C GC/TQ.

Calibration performance over a wide dynamic range with the 7000E and 7010C GC/TQ

The biggest challenge with the multiresidue analysis of food commodities is that the MRLs established for the pesticides vary over a wide range that may require undesirable sample reinjection. Achieving a broad dynamic calibration range can greatly reduce the need for diluting the sample and repeating the analysis.

Bifenthrin has established MRLs in spinach, walnut, and cayenne pepper that are 200, 50, and 500 ppb, respectively. Figure 9 demonstrates the linear calibration curves acquired with the 7000E over the calibration ranges of 0.1 to 1,000 ppb ($R^2 = 0.996$) in spinach, 0.1 to 5,000 ppb ($R^2 = 0.991$) in walnut, and 0.1 to 5,000 ppb ($R^2 = 0.995$) in cayenne pepper, encompassing the established MRL values.

MRLs for pesticide vary significantly not only across various commodities, but also for various pesticides regulated in one commodity. For example, pyriproxyfen and fludioxonil are monitored in spinach with the MRLs of 3,000 and 10 ppb, respectively. Figure 10A demonstrates that the 7000E GC/TQ maintained linear calibration performance for both pyriproxyfen and fludioxonil in spinach extract from 0.1 to 5,000 ppb, while demonstrating excellent accuracy even at low concentrations (see the zoomed in calibration for fludioxonil).

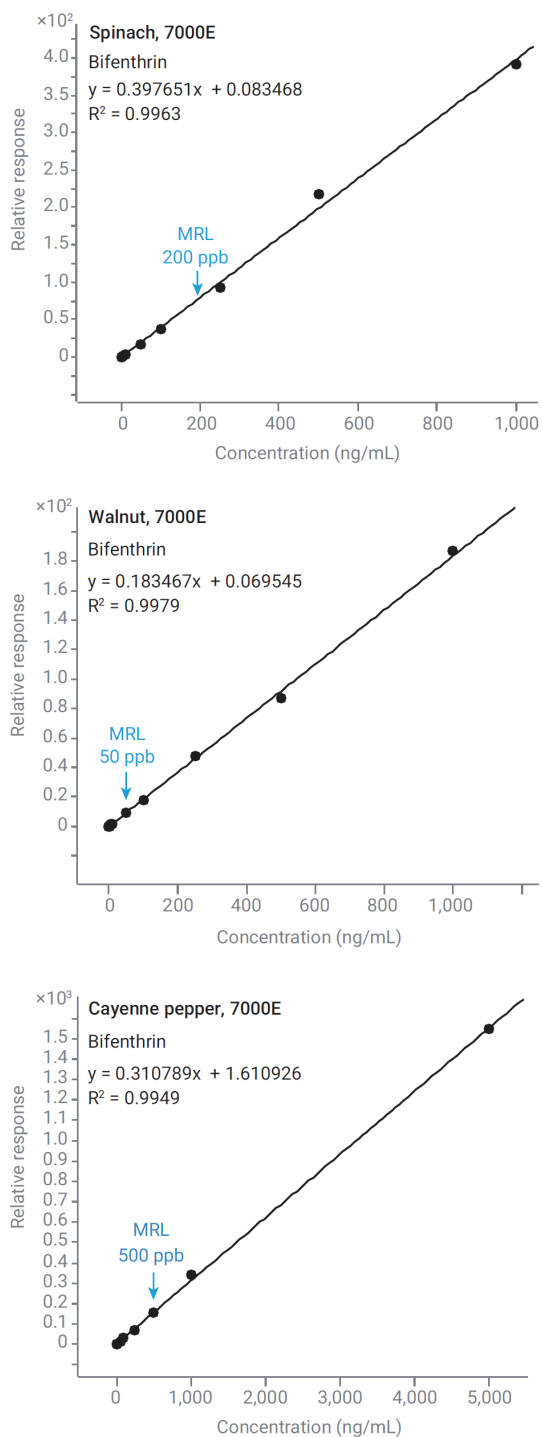

Figure 9. Matrix-matched calibration curves for bifenthrin in spinach, walnut, and cayenne pepper extracts with the 7000E GC/TQ.

As shown in Figure 10B, the 7010C GC/TQ also allowed for achieving a linear calibration curve over a broad range for both pesticides (0.1 to 1,000 ppb). However, the dynamic range of the 7010C would require an extra injection

of a diluted sample to accommodate accurate quantitation of pyriproxyfen at its MRL of 3,000 ppb. While the upper limit of the calibration range achieved with the 7010C for pyriproxyfen and fludioxonil is lower than that with the

7000E, the 7010C delivers a higher sensitivity at lower concentrations. This is shown in Figure 10C and can be critical for the analysis of these pesticides in the commodities with lower established MRLs.

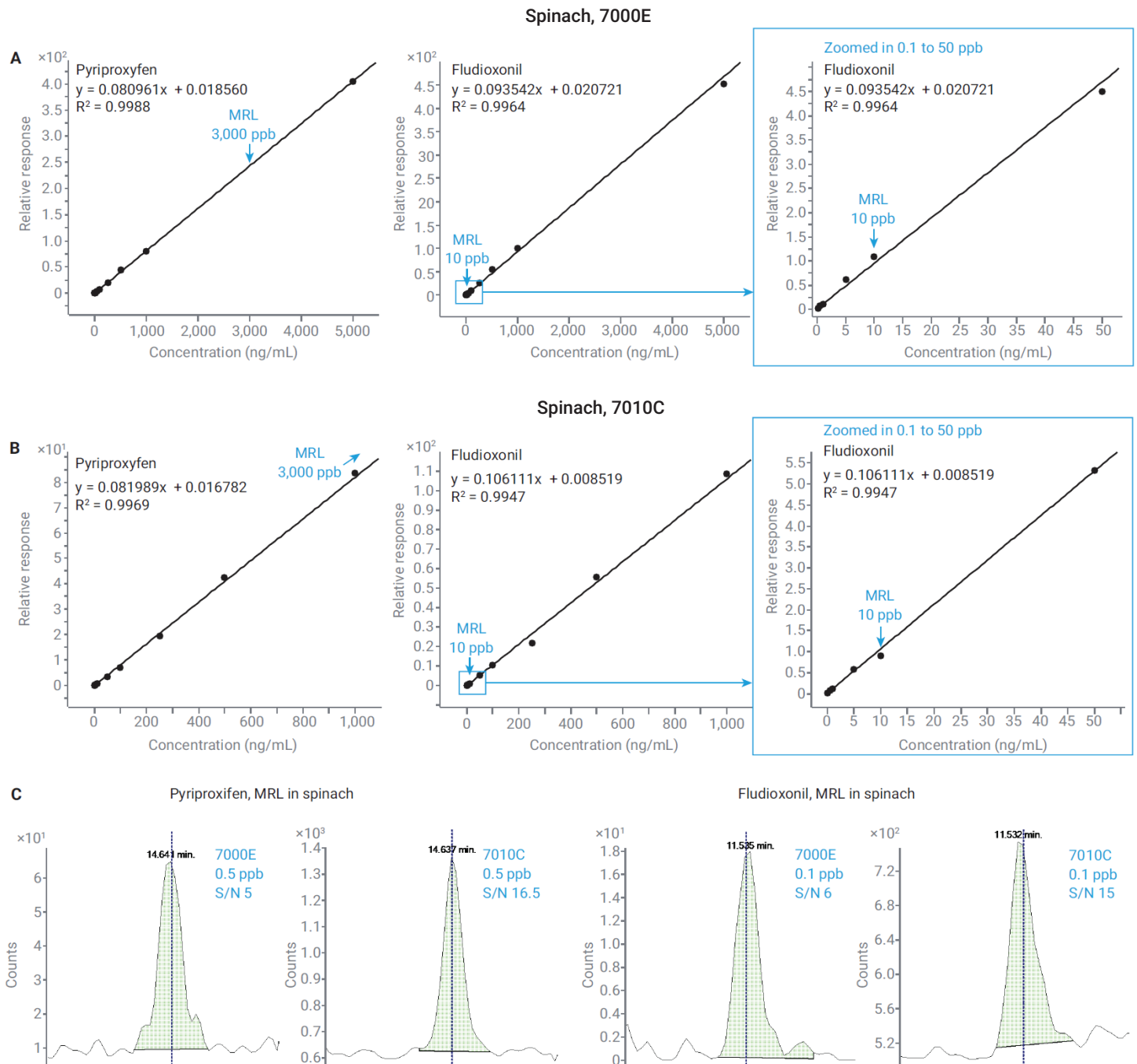

Figure 10. Matrix-matched calibration curves for pyriproxyfen and fludioxonil in spinach QuEChERS extracts with the 7000E GC/TQ (A) and with the 7010C GC/TQ (B); MRM chromatograms for pyriproxyfen and fludioxonil at 0.5 and 0.1 ppb in spinach QuEChERS extract analyzed with the 7000E and the 7010C GC/TQ (C).

Alternatively, samples with the MRLs above 1,000 ppb can be further diluted before the analysis with the 7010C GC/TQ. Superior sensitivity enabled with the HES allows for precise quantitation maintaining low LOQs even in the diluted sample. Additionally, injection of the dilutes samples increased maintenance-free operating time increased the number of injections that could be performed before the GC inlet liner needs replacement.

A summary in Figure 11 shows the calibration performance for the 203 pesticides that were analyzed in spinach, walnut, and cayenne pepper extracts with the 7000E and 7010C GC/TQ systems. The graph illustrates the number of compounds with the calibration correlation coefficient $R^2 > 0.99$, the calibration fit (linear or quadratic), and the calibration range.

As expected, considering the recommended loading for the HES not to exceed 1 ng per analyte, the upper calibration limit for the 7010C was lower when compared to the 7000E (1,000 ppb versus 5,000 ppb). However, the calibration range achieved with the 7010C was up to four orders of magnitude with a linear fit for most of the analyzed compounds. The 7010C GC/TQ equipped with the HES enables superior sensitivity yielding high S/N at low concentrations and allows for accurate quantitation at concentrations below 0.1 ppb. However, this was not required in this work as the MRLs for pesticides regulated in the commodities of interest did not require sub 0.1 ppb quantitation. Alternatively, samples with the MRLs above 1,000 ppb can be further diluted before the analysis with the 7010C GC/TQ. The HES enables maintaining high sensitivity at the LOQ level even in the dilutes sample.

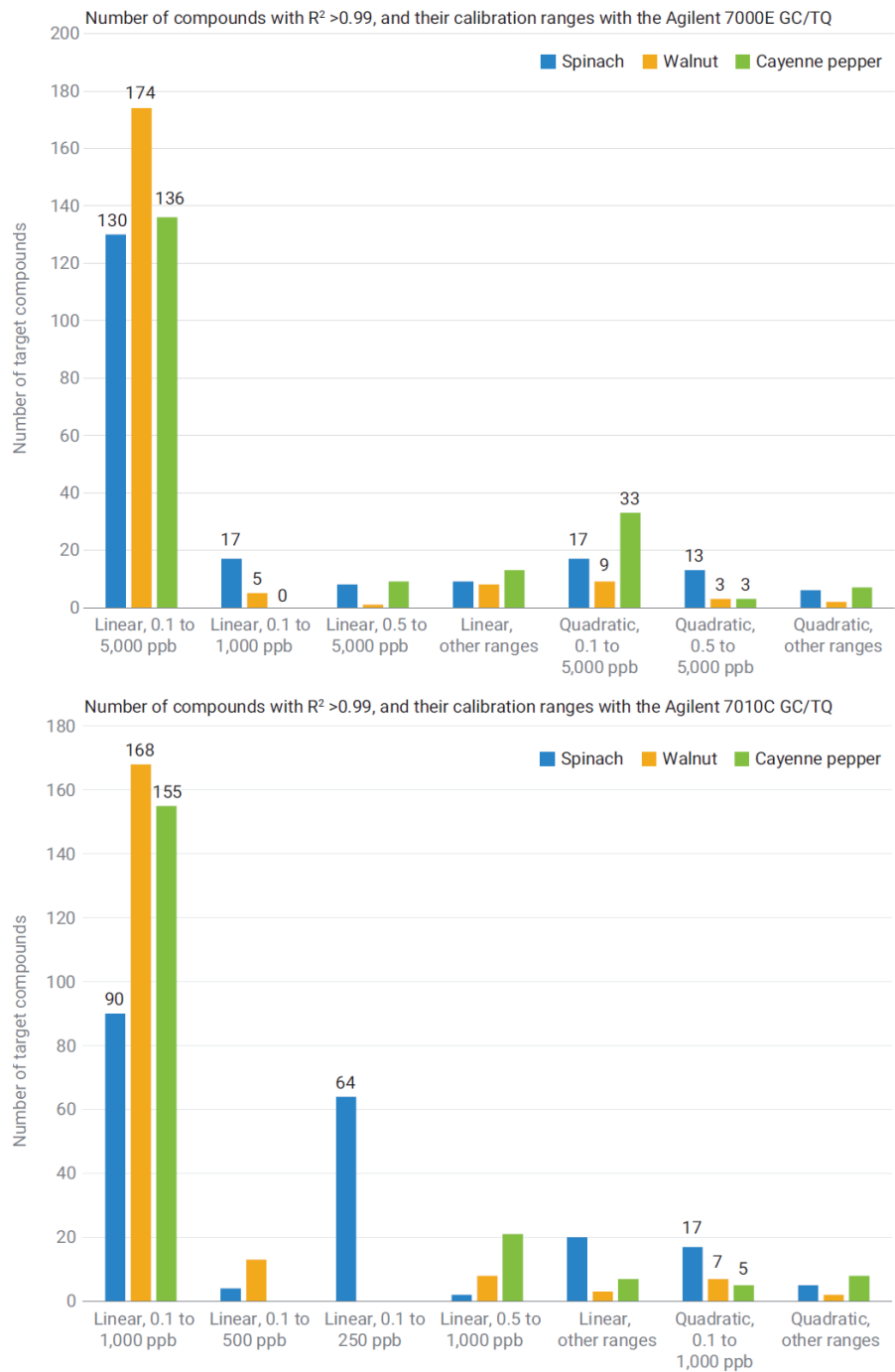

Figure 11. Calibration performance for the 203 pesticides with the 7000E and 7010C GC/TQ in spinach. The graph shows the number of compounds and their calibration ranges.

Conclusion

This application note described five best practices in sample preparation and Agilent 8890/7000E and 8890/7010C triple quadrupole GC/MS system analysis applied to 203 pesticides in challenging food matrices, including spinach, walnut, and cayenne pepper. These practices included:

- Simplified and improved sample preparation achieved with the novel and improved Agilent Captiva EMR pass-through clean up following the traditional Agilent QuEChERS extraction
- Evaluation of in-source loading of the matrix in full scan data acquisition mode
- Midcolumn backflushing
- Leak-free GC/triple quadrupole system enabled with the self-tightening collared column nuts and CFT gold-plated flexible metal ferrules
- Use of temperature-programmed multimode inlet with a 2 mm dimpled liner (no glass wool)

The resulting method allowed for excellent calibration performance over a wide dynamic range up to over four orders of magnitude. The calibration performance was as wide as 0.1 to 5,000 ppb and 0.1 to 1,000 for most of the compounds with the 7000E and the 7010C, respectively. The 7010C demonstrated superior sensitivity yielding a higher signal-to-noise ratio at lower concentrations. The wide dynamic ranges in combination with high sensitivity make the 7000E and the 7010C the ideal tools for analyzing pesticides at their MRLs in various commodities, including those with complex highly pigmented and oily matrices.

References

1. Setting Tolerances for Pesticide Residues in Foods, US EPA <https://www.epa.gov/pesticide-tolerances/setting-tolerances-pesticide-residues-foods>. Accessed on April 28th, **2022**.
2. Index to Pesticide Chemical Names, Part 180 Tolerance Information, and Food and Feed Commodities (by Commodity), US EPA. December 12, 2012. <https://www.epa.gov/sites/default/files/2015-01/documents/tolerances-commodity.pdf> Accessed on April 28th, **2022**.
3. Andrianova, A.; Quimby, B.; Zhao, L. A Fast and Robust GC/MS/MS Analysis of 203 Pesticides in 10 Minutes in Spinach. *Agilent Technologies application note*, publication number 5994-4967EN, **2022**.
4. Andrianova, A.; Quimby, B. Full Scan Quantitative Analysis of Semivolatile Organic Compounds: Evaluating the Performance of an Agilent 7000D GC/TQ in Full Scan Data Acquisition Mode for SVOCs Analysis. *Agilent Technologies application note*, publication number 5994-3859EN, **2021**.
5. Fritz, B. Using the PSD for Backflushing on the Agilent 8890 GC System. *Agilent Technologies application note*, publication number 5994-0550EN, **2018**.
6. Self Tightening Column Nut Installation – Inlet & Detectors. <https://www.agilent.com/en/video/stcn-inlet-detector> Accessed on May 2nd, **2022**.
7. Self Tightening Column Nut Installation – MS Interface. <https://www.agilent.com/en/video/stcn-mass-spec> Accessed on May 2nd, 2022.
8. 40 CFR § 180.291 - Pentachloronitrobenzene; Tolerance for Residues. <https://www.law.cornell.edu/cfr/text/40/180.291> Accessed on May 2nd, **2022**.

Appendix 1

Compounds analyzed in this work and their observed retention times.

Name	Retention Time (min)	Name	Retention Time (min)	Name	Retention Time (min)
Allidochlor	4.893	Pyrimethanil	8.282	DCPA (Dacthal, Chlorthal-dimethyl)	10.062
Dichlorobenzonitrile, 2,6-	5.244	Diazinon	8.291	Fenson	10.201
Biphenyl	5.423	Fluchloralin	8.326	Diphenamid	10.288
Mevinphos, E-	5.597	Disulfoton	8.427	Bromophos	10.297
3,4-Dichloroaniline	5.708	Tefluthrin	8.431	Pirimiphos-ethyl	10.304
Pebulate	5.803	Terbacil	8.432	Isopropalin	10.358
Etridiazole	5.833	BHC- <i>delta</i>	8.504	Cyprodinil	10.407
<i>cis</i> -1,2,3,6-Tetrahydrophthalimide	5.966	Isazofos	8.527	MGK-264	10.443
N-(2,4-dimethylphenyl)formamide	5.973	Triallate	8.569	Isodrin	10.455
Methacrifos	6.055	Chlorothalonil	8.584	Metazachlor	10.532
Chloroneb	6.136	Endosulfan ether	8.857	Pendimethalin	10.535
2-Phenylphenol	6.246	Pentachloroaniline	8.913	Penconazole	10.562
Pentachlorobenzene	6.343	Propanil	8.942	Chlozolinate	10.584
Propachlor	6.888	Dimethachlor	8.996	Heptachlor exo-epoxide	10.621
Tecnazene	6.889	Acetochlor	9.093	Tolyfluanid	10.646
Diphenylamine	6.959	Vinclozolin	9.115	Allethrin	10.648
Cycloate	7.043	Transfluthrin	9.129	Fipronil	10.662
2,3,5,6-Tetrachloroaniline	7.059	Parathion-methyl	9.145	Chlorfenvinphos	10.676
Chlorpropham	7.102	Chlorpyrifos-methyl	9.146	Bromfenvinfos-methyl	10.683
Ethalfuralin	7.139	Tolclofos-methyl	9.233	Captan	10.732
Trifluralin	7.245	Alachlor	9.263	Triadimenol	10.746
Benfluralin	7.279	Propisochlor	9.333	Quinalphos	10.747
Sulfotep	7.376	Heptachlor	9.336	Triflumizole	10.77
Diallate I	7.481	Metalaxyl	9.337	Folpet	10.847
Phorate	7.498	Ronnel	9.396	Procymidone	10.858
BHC- <i>alpha</i> (benzene hexachloride)	7.636	Prodiamine	9.556	Chlorbenside	10.918
Hexachlorobenzene	7.768	Fenitrothion	9.596	Bromophos-ethyl	11.041
Dichloran	7.798	Pirimiphos-methyl	9.598	Chlordane- <i>trans</i>	11.043
Pentachloroanisole	7.823	Linuron	9.668	DDE-o,p'	11.09
Atrazine	7.885	Malathion	9.743	Paclobutrazol	11.106
Clomazone	7.982	Pentachlorothioanisole	9.758	Tetrachlorvinphos	11.169
BHC-beta	8.025	Dichlofluanid	9.764	Endosulfan I (<i>alpha</i> isomer)	11.273
Profluralin	8.117	Metolachlor	9.902	Chlordane- <i>cis</i>	11.305
Terbutylazine	8.119	Anthraquinone	9.916	Flutriafol	11.322
BHC-gamma (Lindane, <i>gamma</i> HCH)	8.146	Fenthion	9.928	Fenamiphos	11.355
Terbufos	8.159	Aldrin	9.942	Chlorfenson	11.382
Propyzamide	8.175	Chlorpyrifos	9.964	Nonachlor, <i>trans</i> -	11.392
Pentachloronitrobenzene	8.219	Parathion	9.98	Bromfenvinfos	11.4
Fonofos	8.251	Triadimefon	10.011	Flutolanil	11.402
Pentachlorobenzonitrile	8.259	Dichlorobenzophenone, 4,4'-	10.033	Iodofenphos	11.479

Name	Retention Time (min)	Name	Retention Time (min)	Name	Retention Time (min)
Prothiofos	11.514	Carbophenothion	12.849	Phenothrin I	14.334
Fludioxonil	11.556	Carfentrazone-ethyl	12.851	Tetradifon	14.445
Profenofos	11.56	Methoxychlor olefin	12.865	Phosalone	14.61
Pretilachlor	11.592	Edifenphos	12.949	Azinphos-methyl	14.64
DDE-p,p'	11.637	Norflurazon	12.964	Pyriproxyfen	14.662
Tricyclazole	11.645	Lenacil	12.976	Leptophos	14.666
Oxadiazon	11.659	Endosulfan sulfate	13.04	Cyhalothrin (<i>Lambda</i>)	14.731
Dieldrin	11.73	DDT-p,p'	13.054	Mirex	14.898
Oxyfluorfen	11.737	Hexazinone	13.23	Acrinathrin	15.076
Myclobutanil	11.747	Methoxychlor, o,p'-	13.241	Fenarimol	15.121
DDD-o,p'	11.799	Tebuconazole	13.294	Pyrazophos	15.168
Flusilazole	11.8	Propargite	13.352	Azinphos-ethyl	15.252
Bupirimate	11.831	Piperonyl butoxide	13.404	Pyraclufos	15.303
Fluazifop-p-butyl	12.007	Resmethrin	13.44	Permethrin, (1R)- <i>cis</i> -	15.656
Nitrofen	12.023	Captafol	13.466	Permethrin, (1R)- <i>trans</i> -	15.772
Ethylan	12.063	Nitralin	13.563	Pyridaben	15.807
Chlorfenapyr	12.064	Iprodione	13.726	Fluquinconazole	15.895
Endrin	12.127	Tetramethrin I	13.836	Coumaphos	15.902
Chlorobenzilate	12.194	Pyridaphenthion	13.838	Prochloraz	15.958
Endosulfan II (beta isomer)	12.291	Endrin ketone	13.898	Cyfluthrin I	16.207
DDD-p,p'	12.383	Phosmet	13.931	Cypermethrin I	16.421
Ethion	12.453	Bromopropylate	13.952	Flucythrinate I	16.75
DDT-o,p'	12.457	EPN	13.955	Ethofenprox	16.829
Chlorthiophos	12.503	Bifenthrin	13.956	Fluridone	17.034
Nonachlor, <i>cis</i> -	12.508	Methoxychlor, p,p'-	14.062	Fenvalerate I	17.459
Endrin aldehyde	12.618	Fenpropathrin	14.077	Fluvalinate-tau I	17.646
Sulprofos	12.669	Tebufenpyrad	14.142	Deltamethrin	18.177
Triazophos	12.674				

www.agilent.com

DE10556921

This information is subject to change without notice.

© Agilent Technologies, Inc. 2022
Printed in the USA, September 13, 2022
5994-4965EN

Dynamic MRM/Scan Mode: Adding More Confidence to Sensitive Quantitation in Complex Foods by Triple Quadrupole GC/MS (GC/TQ)



Authors

Anastasia A. Andrianova,
Bruce D. Quimby, and
Limian Zhao
Agilent Technologies, Inc.

Abstract

This application note describes the use of the novel simultaneous dynamic multiple reaction monitoring (dMRM) and scan (dMRM/scan) data acquisition mode for triple quadrupole gas chromatography mass spectrometry (GC/TQ) analysis of pesticides in challenging food matrices. The simultaneous dMRM/scan capability enables identification of the unknown compounds and retrospective analysis, while maintaining sensitivity and dynamic range of the method comparable to a conventional dMRM analysis. Additionally, scan data enables more confidence in compound identification by library spectrum matching. Finally, the full scan data allow the analyst to evaluate the sample matrix to ensure the most efficient performance of the GC/TQ system.

This work demonstrates the application of dMRM/scan to the analysis of extracts, using Agilent QuEChERS sample preparation, of spinach, walnut, and cayenne pepper spiked with over 200 pesticides. The calibration results and method sensitivity for 203 evaluated compounds were comparable to results observed with conventional dMRM data acquisition mode with the Agilent 8890/7000E GC/TQ and the Agilent 8890/7010C GC/TQ.

The unknown identification workflow based on the spectral library matching using a retention time locked library was carried out with Agilent MassHunter Unknowns Analysis. Many of the compounds with the established maximum residue limits (MRLs) were identified with full scan data at concentrations below their MRLs even in the challenging cayenne pepper extract.

Introduction

Concern about trace-level food contaminants is driving the demand for robust, rapid, and reliable methods for identification and quantitation of chemical residues and contaminants in food matrices. Usually, the detection methods such as triple quadrupole GC/MS and triple quadrupole LC/MS are aimed at a specific list of targets that are commonly found in food samples. These methods can be effective but may overlook any residues that are not specifically targeted. The approach to overcome this challenge is to perform untargeted screening of the sample intending to find as many compounds of concern as possible and allowing for retrospective analysis. Untargeted screening can be accomplished by analyzing the sample in full scan data acquisition mode.^{1,2} However, targeted triple quadrupole GC/MS (GC/TQ) analysis has an advantage of higher sensitivity and selectivity for the target analytes when compared to full scan analysis. The novel simultaneous dynamic MRM and scan (dMRM/scan)

allows for acquiring both targeted dMRM GC/TQ data for target quantitation as well as full scan data for unknowns screening. Also, the simultaneous dynamic MRM and scan (dMRM/scan) deliver confident identification based on spectral library matching.

In this work, three challenging matrices, including a high-chlorophyll fresh spinach matrix, an oily dry walnut matrix, and a complex dry cayenne pepper matrix were used. The matrix blank extracts were post spiked with over 200 GC-amenable pesticides. The samples at various concentration levels were analyzed in dMRM/scan data acquisition mode enabling target quantitation with dMRM data and unknown identification with the simultaneously acquired full scan data. The performance of the targeted GC/TQ method component was evaluated based on the method sensitivity and the calibration performance over a dynamic range. The screening component of the method was evaluated based on the number of identified compounds and the concentration at which they could be reliably detected in full scan.

Experimental

GC/TQ analysis

The **8890/7000E** and **8890/7010C** triple quadrupole GC/MS systems (GC/TQ) were used and configured to achieve the best performance over a wide calibration range (Figure 1A). This calibration range encompassed the varying maximum residue limits (MRLs) for pesticides regulated in the analyzed commodities. The GC was configured with the Agilent 7693A automatic liquid sampler (ALS) and 150-position tray. The system used a multimode inlet (MMI) operated in temperature-programmed splitless injection mode. Midcolumn backflush capability was provided by the Agilent Purged Ultimate Union (PUU) installed between two identical 15 m columns, and the 8890 pneumatic switching device (PSD) module (Figure 1B).

The instrument method parameters are listed in Table 1 and Figure 2 demonstrates how dMRM/scan mode is set up in the triple quadrupole MS Method Editor of Agilent MassHunter Workstation software and the

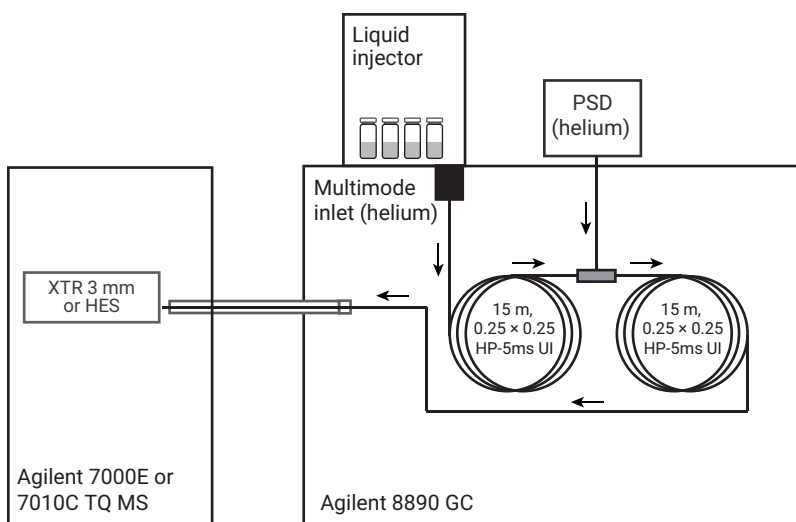

Figure 1. The Agilent 8890/7000E and 8890/7010C GC/TQ system (A) and system configuration (B).

Table 1. Agilent 8890/7000E and 8890/7010C GC/TQ conditions for simultaneous dynamic MRM and scan (dMRM/scan) pesticide analysis.

Parameter	Value
GC	Agilent 8890 with fast oven, auto injector and tray
Inlet	Multimode Inlet (MMI)
Mode	Splitless
Purge Flow to Split Vent	60 mL/min at 0.75 min
Septum Purge Flow	3 mL/min
Septum Purge Flow Mode	Switched
Injection Volume	1.0 µL
Injection Type	Standard
L1 Airgap	0.2 µL
Gas Saver	On at 30 mL/min after 3 min
Inlet Temperature	60 °C for 0.1 min, then to 280 °C at 600 °C/min
Post Run Inlet Temperature	310 °C
Post Run Total Flow	25 mL/min
Carrier Gas	Helium
Inlet Liner	Agilent Ultra Inert 2 mm dimpled liner, splitless
Inlet Liner Part Number	5190-2297
Oven	
Initial Oven Temperature	60 °C
Initial Oven Hold	1 min
Ramp Rate 1	40 °C/min
Final Temperature 1	170 °C
Final Hold 1	0 min
Ramp Rate 2	10 °C /min
Final Temperature 2	310 °C
Final Hold 2	2.25 min
Total Run Time	20 min
Post Run Time	1.5 min
Equilibration Time	0.25 min
Column 1	
Type	Agilent HP-5ms UI, 15 m × 0.25 mm, 0.25 µm (p/n 19091S-431UI-KEY)
Control Mode	Constant flow
Flow	1.016 mL/min
Inlet Connection	Multimode inlet (MMI)
Outlet Connection	PSD (PUU)
PSD Purge Flow	5 mL/min
Post Run Flow (Backflushing)	-7.873

Parameter	Value
Column 2	
Type	Agilent HP-5ms UI, 15 m × 0.25 mm, 0.25 µm (p/n 19091S-431UI-KEY)
Control Mode	Constant flow
Flow	1.216 mL/min
Inlet Connection	PSD (PUU)
Outlet Connection	MSD
Post Run Flow (Backflushing)	8.202
MSD	
Model	Agilent 7000E or 7010C
Source	Inert extractor source with a 3 mm lens or high efficiency source (HES)
Vacuum Pump	Performance turbo
Tune File	Atunes.eiex.jtune.xml or Atunes.eihs.jtune.xml
Solvent Delay	3 min
Quad Temperature (MS1 and MS2)	150 °C
Source Temperature	280 °C
Mode	Simultaneous dMRM/scan
He Quench Gas	2.25 mL/min
N ₂ Collision Gas	1.5 mL/min
MRM Statistics	
Total MRMs (dMRM Mode)	614
Minimum Dwell Time (ms)	6.85
Minimum Cycle Time (ms)	69.8
Maximum Concurrent MRMs	52
EM voltage Gain Mode	10
Full Scan Parameters	
Scan Type	MS1 scan
Scan Range	45 to 450 m/z
Scan Time (ms)	220
Step Size	0.1 amu
Profile Data	No
Threshold	0

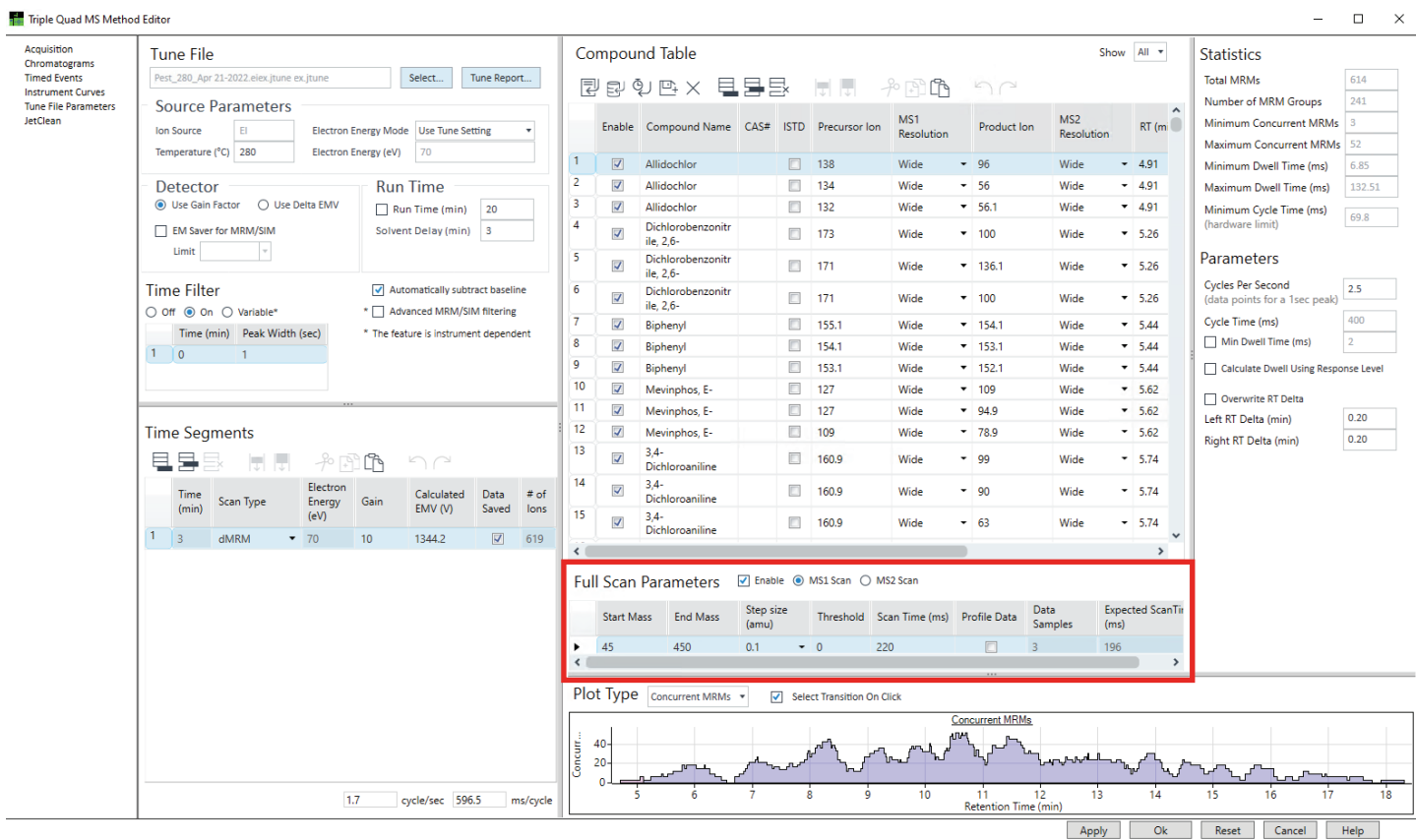

Figure 2. Triple quadrupole MS Method Editor showing the full scan acquisition parameters used for simultaneous dMRM/scan in this work.

recommended parameters used for sample screening. Additional details on the best practices for full scan data acquisition and processing using GC/TQ can be found in the application note 5994-3859EN.¹

Data were acquired in dMRM/scan mode with one analytical run, enabling simultaneous targeted large multi-analyte assays and full scan data acquisition for unknown identification and retrospective analysis. The acquisition method was retention time-locked to match the retention times in the Agilent MassHunter Pesticide & Environmental Pollutant MRM Database

(P&EP 4). The data file size difference of dMRM/scan for a 20-minute analysis compared to dMRM only was ~20 MB. For example, the file size for cayenne pepper extract analyzed in dMRM/scan mode that included 614 MRM transitions and full scan over 45 to 450 *m/z* is 30 MB. The same sample analyzed in dMRM only mode results in the file size of 11 MB.

Data acquisition and processing was performed with the Agilent MassHunter Workstation versions 10.1 and higher.

Calibration performance was evaluated using a series of matrix-matched calibration standards ranging from

0.1 to 1,000 ppb (w/v), including 0.1, 0.5, 1, 5, 10, 50, 100, 250, 500, 1,000, and 5,000 ppb. The GC multiresidue pesticide kit containing 203 compounds (Restek, Bellefonte, PA, USA), regulated by the FDA, USDA, and other global governmental agencies, was used for preparing matrix-matched calibration standards. A standard, α -BHC-d₆, at a final concentration of 20 ppb in vial, was used as the internal standard for quantitation of the target pesticides (Agilent Bond Elut QuEChERS IS standard number 6, part number PPS-610-1). A weighting factor of 1/x was applied to all calibration curves.

Sample preparation

Sample preparation workflow chart is shown in Figure 3. The sample preparation included two major steps: Sample extraction by traditional QuEChERS extraction, followed with Agilent Captiva EMR pass-through cleanup. Different Captiva EMR products were used for different matrices based on different matrix challenges. Captiva EMR-HCF1 (part number 5610-2088) cartridge was used for high-chlorophyll fresh matrix spinach. Captiva EMR-LPD (part number 5610-2092) was used for the low pigmented but oily dry matrix walnut. Captiva EMR-GPD (part number 5610-2091) was used for a very challenging dry matrix cayenne pepper. The positive pressure manifold 48 processor (PPM-48, part number 5191-4101) was used for Captiva EMR pass-through cleanup

processing. The new sample preparation workflow demonstrates a simplified procedure with improvement on both sample matrix removal and targets quantitation data quality. Figure 3 shows the sample preparation workflow. More details on the sample preparation workflow can be found in the application note 5994-4965EN.³

Results and discussion

The data acquired in simultaneous dMRM/scan mode can serve several important functions that are summarized in Figure 4.

The approach to handling and using the dMRM data remains unchanged when comparing to a conventional targeted GC/MS/MS analysis in dMRM data acquisition mode (highlighted in green in Figure 4). Simultaneous acquisition of

full scan data provides three additional functionalities highlighted in blue in Figure 4.

Evaluation of the matrix in full scan

First, performing matrix screening in full scan data acquisition mode facilitates the evaluation of in-source matrix loading. The application note 5994-4965EN⁴ describes the importance of analyzing matrix in full scan mode. This analysis allows users to evaluate the absolute abundance of the total ion chromatogram (TIC), which is recommended not to exceed 7×10^7 counts for GC/TQ. Evaluation of the TIC in full scan mode can signal that the EI source might be overloaded with matrix at any retention time. Source overloading could lead to compromised sensitivity and quantitation accuracy of coeluting analytes.

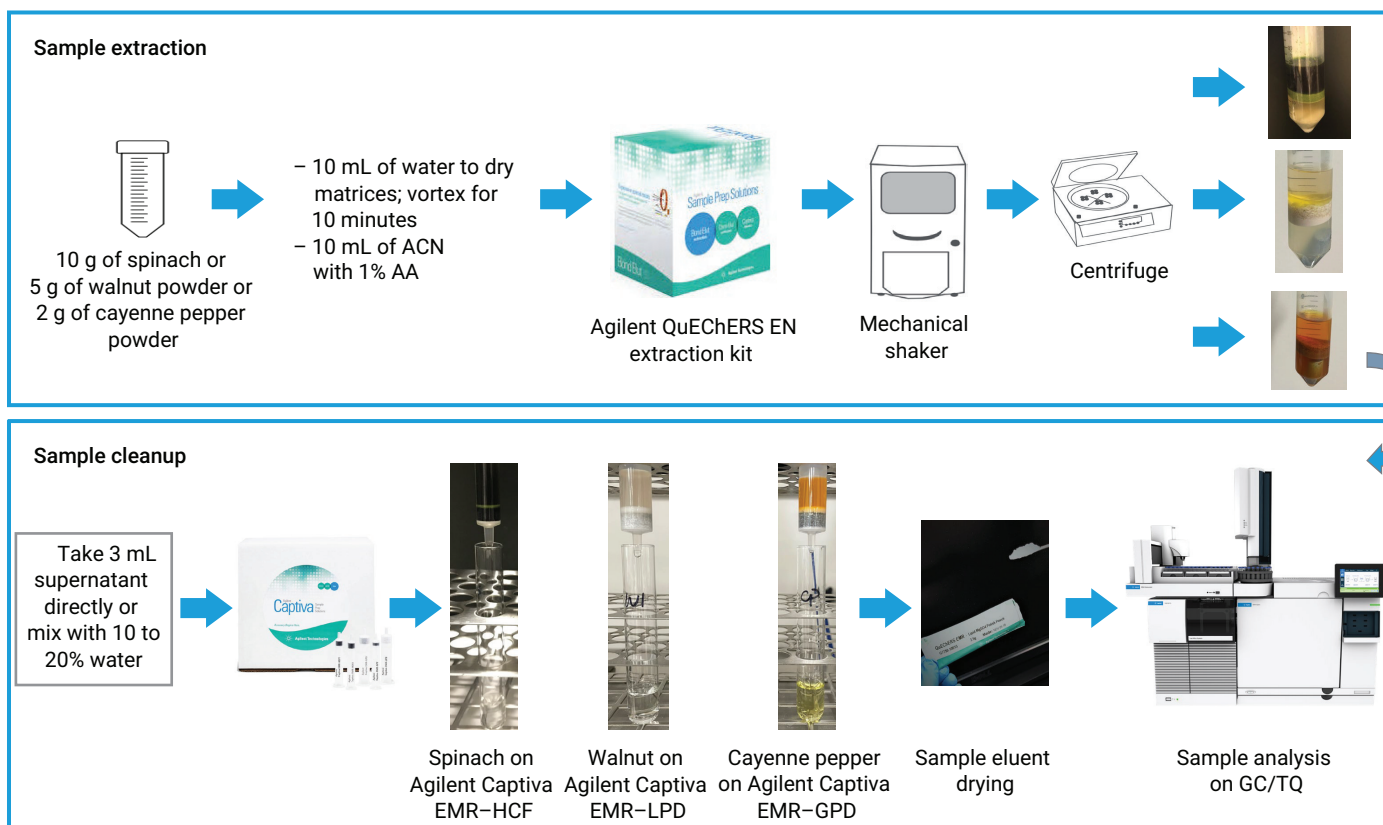

Figure 3. Sample preparation flowchart including traditional QuEChERS extraction, followed with Captiva EMR pass-through clean up.

Out of the three analyzed matrices, cayenne pepper featured the highest matrix background, with the TIC in scan exceeding 7×10^7 counts, as shown in Figure 5. Also, The MRM TIC on the bottom of Figure 5C shows that more MRM transitions were disturbed or had a higher background in cayenne pepper extract when compared to spinach and walnut extracts. This evaluation revealed that pesticides eluting between 11 and 12.5 minutes were expected to have compromised performance in the cayenne pepper matrix when evaluating sensitivity and the dynamic range.

For example, endosulfan I (α -endosulfan) eluted at 11.273 minutes and could be quantitated only starting at 5 ppb in the cayenne pepper matrix. However, endosulfan I could be quantitated down to 0.1 ppb in spinach and walnut extracts with both 7000E and 7010C GC/TQ systems. Evaluation of TIC in full scan reveals that cayenne pepper extract has more interferences originating from matrix interferences coeluting with endosulfan I than the other two matrices. However, the stereoisomer endosulfan II (β -endosulfan) eluted at 12.291 minutes, could be quantitated down to 0.1 ppb in all three matrices with fewer coeluting components arising from the cayenne pepper matrix.

One analytical run

- Evaluation of the matrix in full scan
- Identification of the unknowns and retrospective analysis
- Confirmation of targets with the library match score

Scan

- Confirmation of targets with the MRM quantifier, qualifiers, and the retention time
- Quantitation using dMRM with sensitivity and dynamic range comparable to a conventional dMRM analysis

dMRM

Figure 4. Functionality enabled with simultaneous dMRM/scan data acquisition mode within one analytical run.

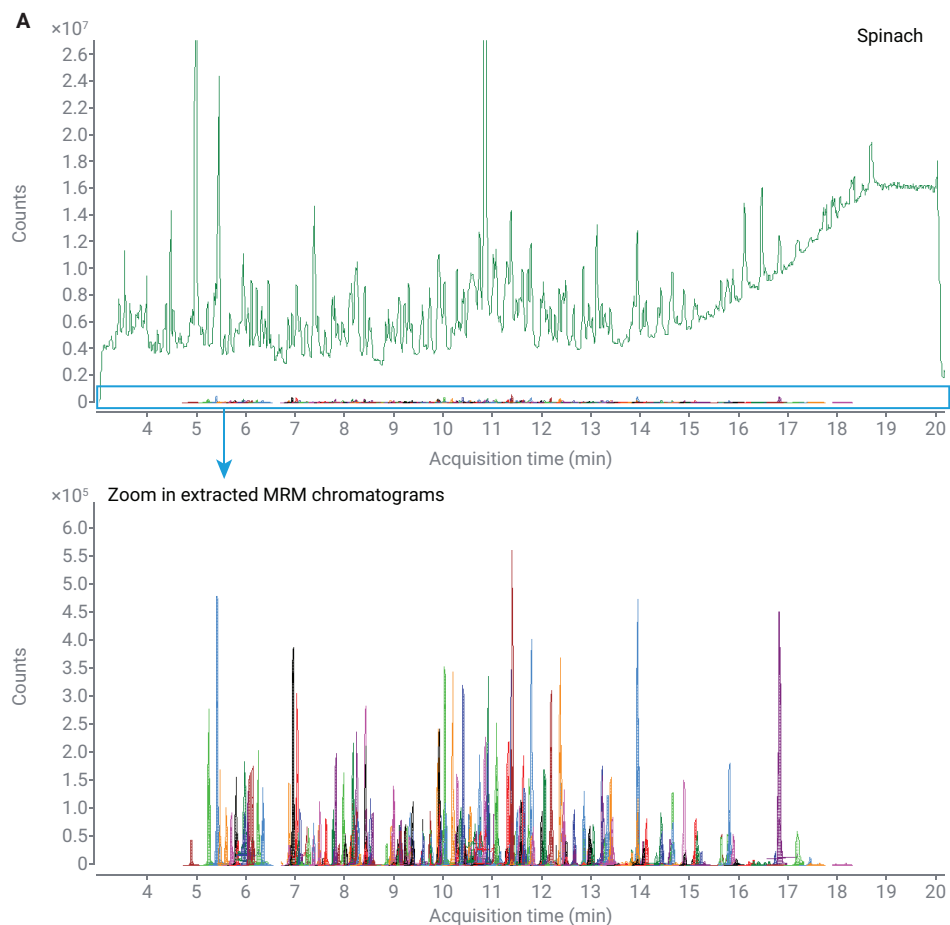

Figure 5A. Scan (on top) and dMRM (magnified on the bottom) TIC acquired in simultaneous dMRM/scan data acquisition mode for spinach extract.

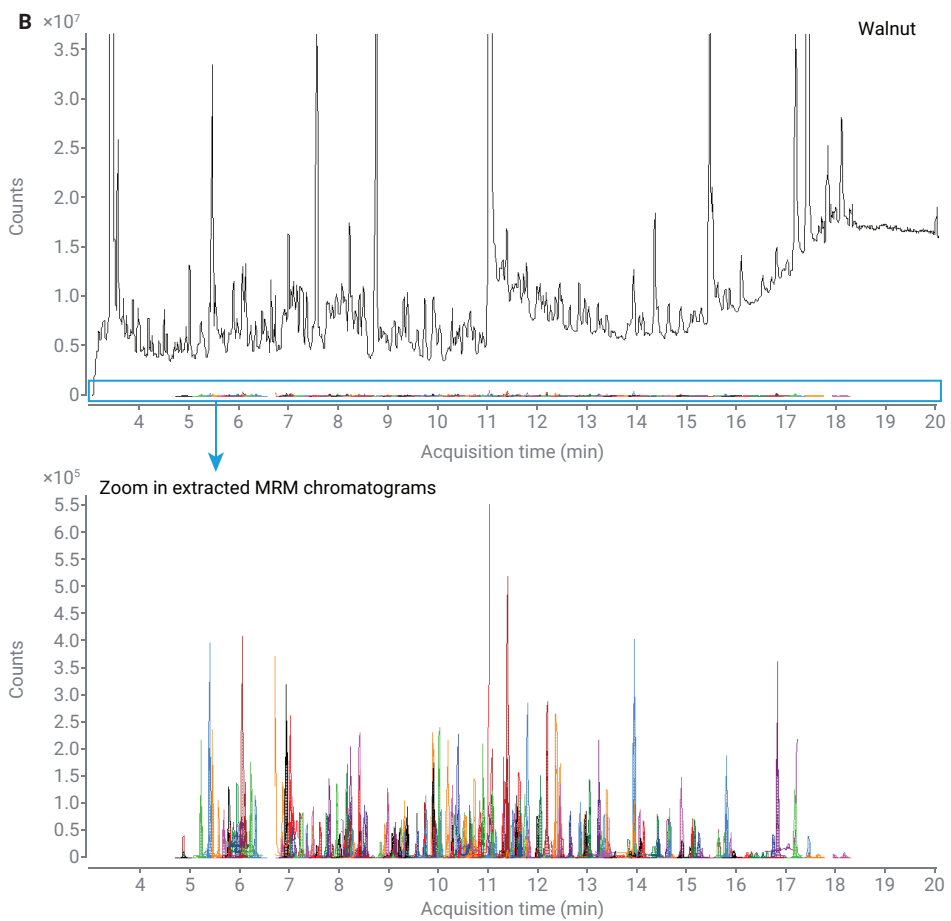

Figure 5B. Scan (on top) and dMRM (magnified on the bottom) TIC acquired in simultaneous dMRM/scan data acquisition mode for walnut extract.

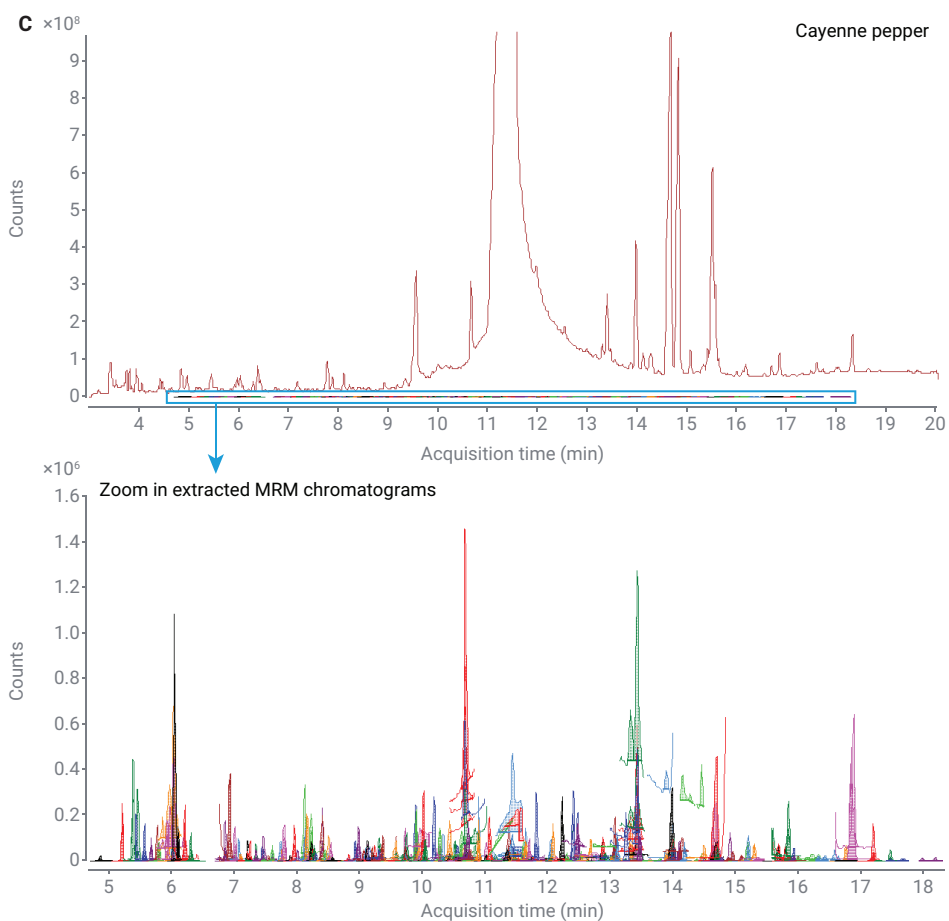

Figure 5C. Scan (on top) and dMRM (magnified on the bottom) TIC acquired in simultaneous dMRM/scan data acquisition mode for cayenne pepper extract.

Identification of the unknowns and retrospective analysis

Simultaneous dMRM/scan data acquisition mode allows for acquisition and storage of the full scan data for each analyzed sample. Full scan data unlock the opportunity to perform compound screening via spectral deconvolution and component search against GC/MS spectral libraries such as NIST. This functionality is valuable for retrospective analysis, eliminating the need to reanalyze the sample.

The 2016 Pesticide Data Program Annual Summary presented by USDA⁴ revealed that chlorpropham was detected in one of the 707 analyzed spinach samples, while this herbicide does not have a tolerance established by EPA for use on spinach.⁵ Since there is no tolerance established for chlorpropham, it is likely that this analyte is not on the target list for the GC/MS/MS method when analyzing spinach samples. Figure 6 demonstrates that chlorpropham was identified in the spinach QuEChERS extract with MassHunter Unknowns Analysis with a screening workflow against a retention time locked pesticide library. In this work, chlorpropham was spiked into spinach matrix to verify the ability to identify the compound using full scan data acquired simultaneously with the dMRM data in dMRM/scan data acquisition mode. Chlorpropham was successfully identified in spinach QuEChERS extract at a concentration of 50 ppb and above with the 7000E and the 7010C GC/TQ systems.

Figure 6 illustrates the screening results for spinach extract spiked with a pesticide mixture at 100 ppb. Chlorpropham was among the identified components and is highlighted in blue in the components table. The library match score (LMS) was 72 and the delta between the observed retention time and the retention time provided in the spectral library was 0.009 minutes. The

lower right of Figure 6 shows the spectral information displayed in MassHunter Unknowns Analysis for the hit. The raw mass spectrum appears on the lower right and a mirror plot compares the deconvoluted mass spectrum to the library spectrum. The magnified chromatogram on the upper right highlights the component corresponding to chlorpropham in red. Other identified

components are shown in green, and the TIC scan profile in black.

Note that some identified compounds such as alachlor, aldrin, and carfentrazone-ethyl had low LMS <60. However, small retention time delta and presence of the unique ions in the mass spectrum increased confidence in their identification.

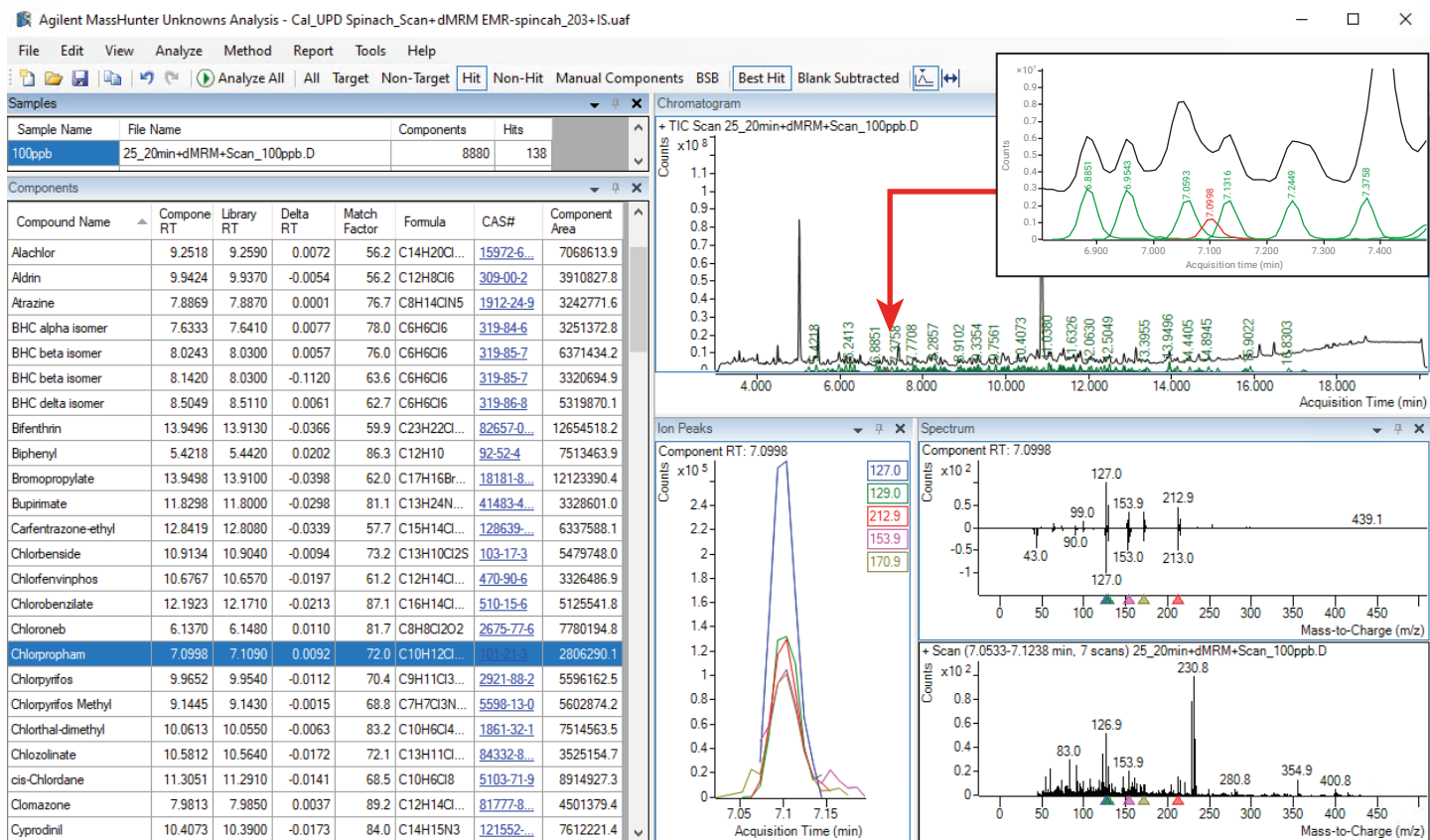

Figure 6. A partial list of search results for spinach extract spiked with a pesticide mixture at 100 ppb against a retention time-locked spectral library. Chlorpropham is selected in the components table and its extracted ion chromatograms and corresponding spectral information are shown on the lower right. The data were acquired with the 7000E GC/TQ in simultaneous dMRM/scan mode.

Confirmation of targets with library match score

The third functionality enabled with scan data acquired simultaneously with dMRM data is confirmation of targets with LMS. This functionality allows for increased confidence in compound identification that is especially important when reporting compounds quantitated above their MRLs. For example, if a compound is quantitated with dMRM at a concentration exceeding the MRL, the scan data can be evaluated to further confirm the finding.

Table 2 lists several pesticides among those spiked into the cayenne pepper extract that have established tolerances in non-bell pepper and spices applicable to cayenne pepper. Out of ten compounds, eight were identified with the 7000E GC/TQ based on spectral matching at concentrations less than or equal to the established MRL (highlighted in green in Table 2).

Figure 7 demonstrates the mirror plot of the deconvoluted mass spectrum from MassHunter Unknowns Analysis screening against the library spectrum at 100 ppb in cayenne pepper for bifenthrin (Figure 7A), chlorpyrifos (Figure 7B), and metolachlor (Figure 7C). These pesticides could be identified below their MRL level with scan data. They are highlighted in bold in Table 2. LMS at 100 ppb and at the MRL level are specified in the figure. The LMS values at 100 ppb and at the established MRL levels are noted in Figure 7. Typically, LMS values below 65 should trigger inspection of a hit. Based only on spectral match, this hits with LMS <65 might be rejected. For example, for bifenthrin and chlorpyrifos, there are three of the principal ions present in approximately the right ratios, and the RTs are within 0.074 and 0.033 minutes of those in the RTL library. The expected ion ratios and close RT matching increase confidence in correct compound identification.

Table 2. Pesticides among those spiked into the cayenne pepper extract that have established MRLs and the concentration required to identify them with the 7000E GC/TQ in simultaneous dMRM/scan.

Electronic Code of Federal Regulations (eCFR)	Commodity	Compound	Tolerance/MRL (ppb)	Scan identification limit on 7000E GC/TQ (ppb)
180.442	Pepper, non-bell	Bifenthrin	500	100
180.515	Herbs and spice, group 19	Carfentrazone-ethyl	2,000	250
180.342	Pepper	Chlorpyrifos	1,000	50
180.425	Pepper	Clomazone	50	50
180.436	Pepper	Cyfluthrin and beta-cyfluthrin	500	1,000
180.153	Pepper	Diazinon	500	250
180.182	Pepper	Endosulfan	2,000	500
180.516	Herbs and spice, group 19	Fludioxonil	20	5,000
180.111	Pepper	Malathion	8,000	250
180.368	Pepper, non-bell	Metolachlor	500	100

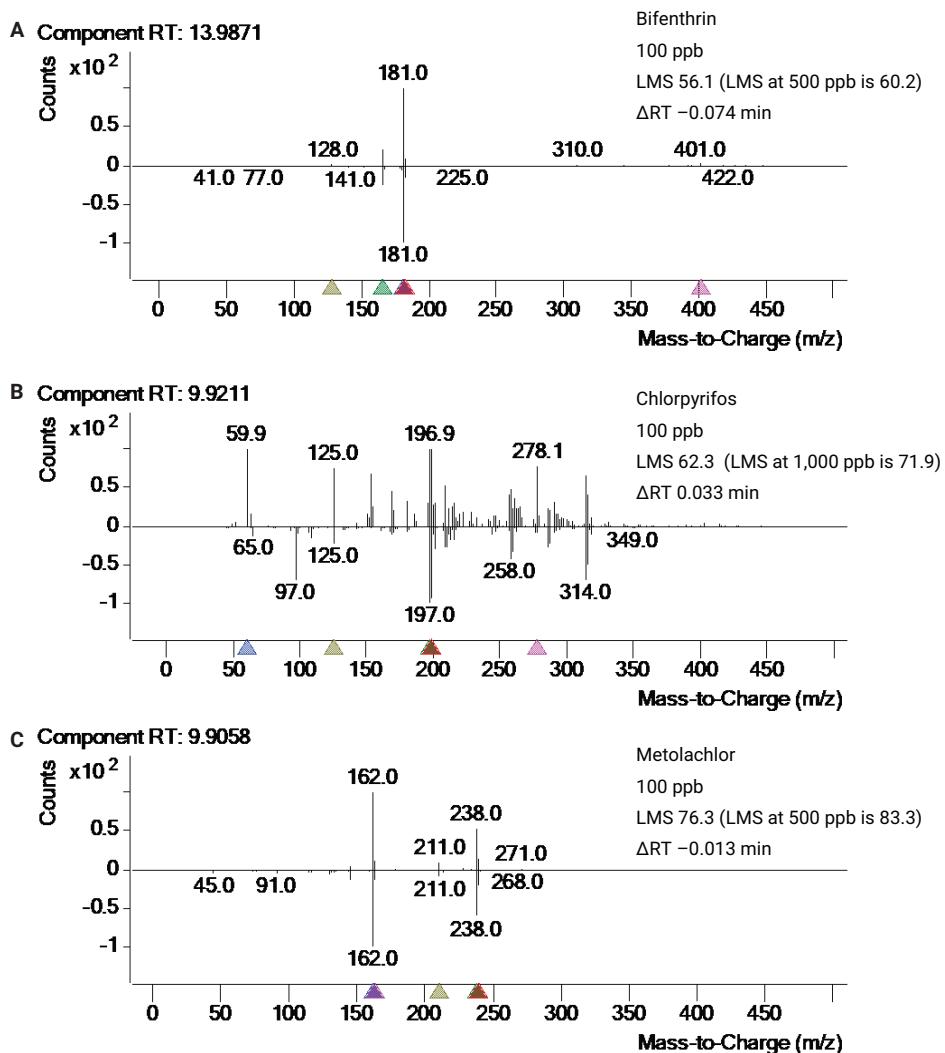

Figure 7. Spectral confirmation with library match score for bifenthrin (A), chlorpyrifos (B), and metolachlor (C) spiked at 100 ppb in cayenne pepper with the Agilent 7000E GC/TQ in simultaneous dMRM/scan data acquisition mode.

Pesticide quantitation with dMRM acquired in simultaneous dMRM/scan

Figure 8 provides the comparative quantitation results for three pesticides that have established MRLs in cayenne pepper. The samples were analyzed in simultaneous dMRM/scan and

dMRM only data acquisition modes with the 7000E GC/TQ. The quantifier and the qualifier MRM chromatograms demonstrate comparable sensitivity at 0.1 ppb with anticipated slight sensitivity loss observed in dMRM/scan resulting from decreased dwell time due to

simultaneous scanning. With both acquisition methods, excellent calibration linearity over the range 0.1 to 5,000 ppb for matrix-matched calibration standards in cayenne pepper was observed. The quantitation accuracy at the MRL level is noted in the figure.

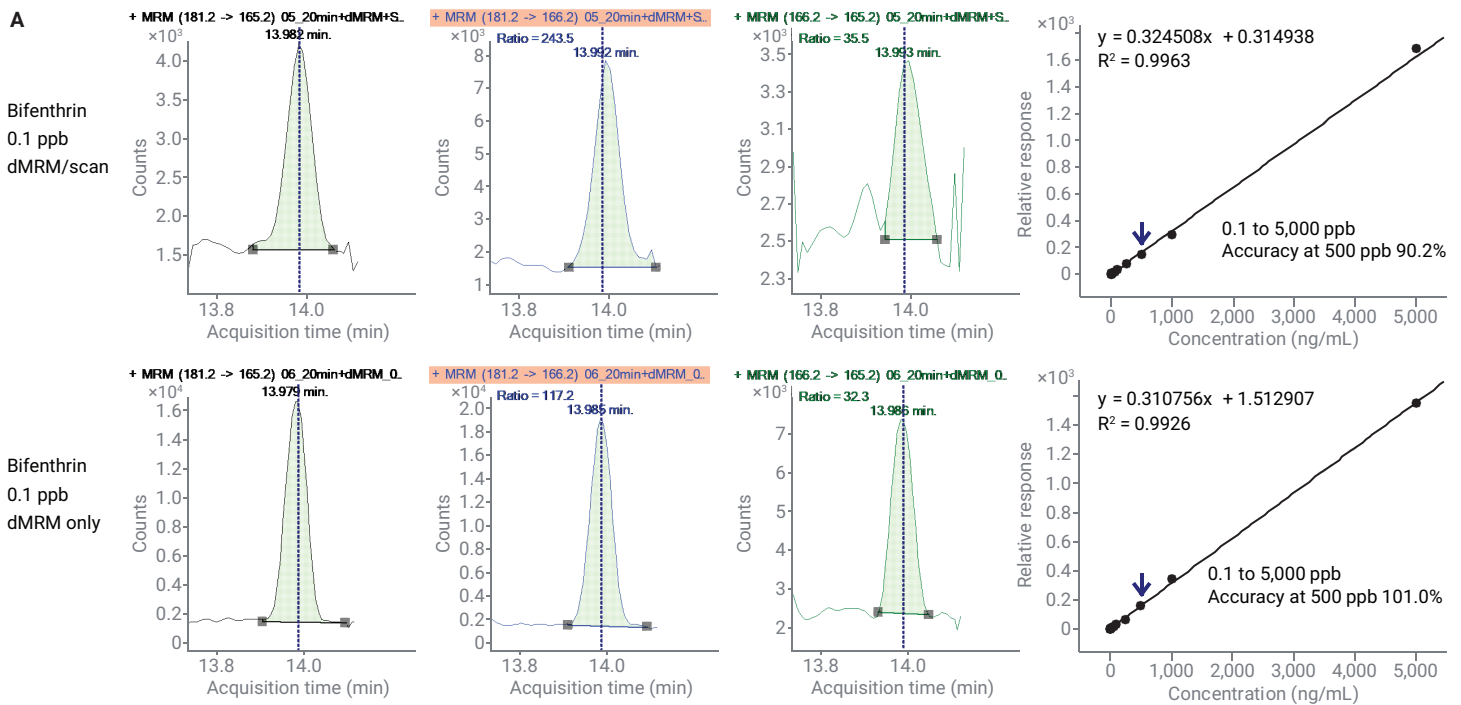

Figure 8A. Quantifier and qualifier ion profiles and matrix-matched calibration curves over 0.1 to 5,000 ppb for bifenthrin spiked at 100 ppb in cayenne pepper with the Agilent 7000E GC/TQ in simultaneous dMRM/scan and dMRM only data acquisition modes.

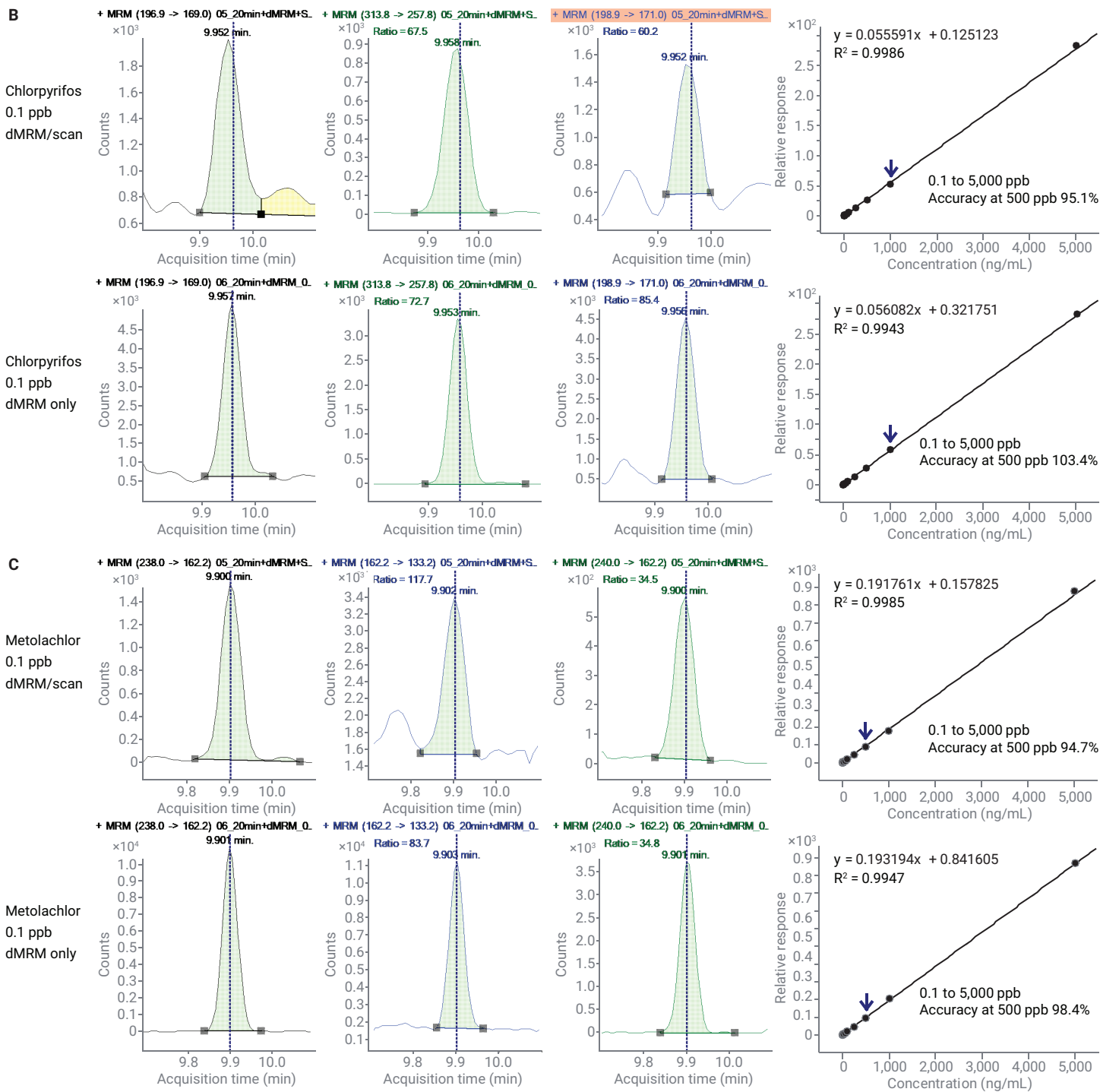

Figure 8B,C. Quantifier and qualifier ion profiles and matrix-matched calibration curves over 0.1 to 5,000 ppb for chlorpyrifos (B) and metolachlor (C) spiked at 100 ppb in cayenne pepper with the Agilent 7000E GC/TQ in simultaneous dMRM/scan and dMRM only data acquisition modes.

A summary in Figure 9 shows the calibration performance using dMRM data acquired in simultaneous dMRM/scan mode for the 203 pesticides that were analyzed in spinach, walnut, and cayenne pepper extracts with the 7000E and 7010C GC/TQ systems. The figure illustrates the number of compounds successfully meeting the correlation coefficient $R^2 > 0.99$, the calibration fit (linear or quadratic), and the calibration range. The calibration results and method sensitivity were comparable to those observed with conventional dMRM data acquisition mode as shown in the application note 5994-4965EN.³

As expected, considering the recommended loading for the high efficiency source (HES) not to exceed 1 ng per analyte, the upper calibration limit for the 7010C was lower when compared to the 7000E (1,000 ppb versus 5,000 ppb). However, the calibration range achieved with the 7010C was up to four orders of magnitude with a linear fit for most of the analyzed compounds. The 7010C GC/TQ equipped with the HES enables superior sensitivity yielding high signal-to-noise (S/N) at low concentrations and allows for accurate quantitation at concentrations below 0.1 ppb. However, this sensitivity was not required in this work as the MRLs for pesticides regulated in the commodities of interest did not require sub 0.1 ppb quantitation. Alternatively, samples with the MRLs above 1,000 ppb can be further diluted before the analysis with the 7010C GC/TQ. The HES enables maintaining high sensitivity at the LOQ level even in the diluted samples.

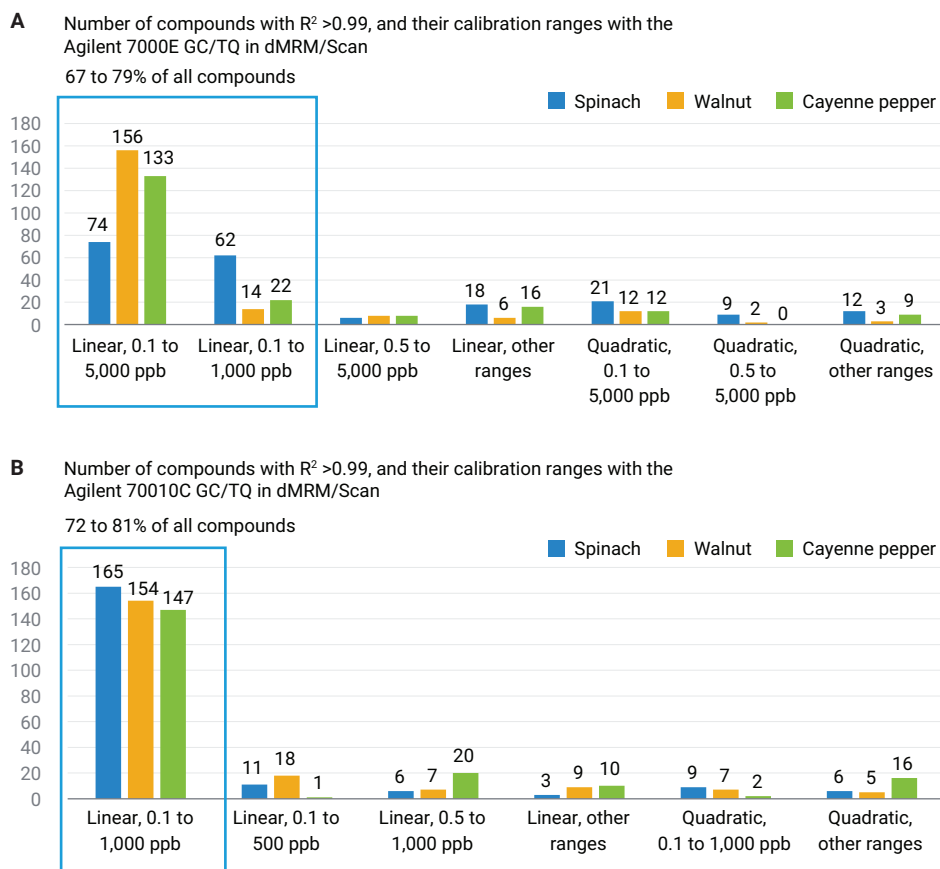

Figure 9. Calibration performance for the 203 pesticides with an Agilent 7000E (A) and Agilent 7010C (B) GC/TQ in spinach, walnut, and cayenne pepper QuEChERS extracts. The graph shows the number of compounds and their calibration ranges.

Conclusion

This application note described the use of the novel simultaneous dMRM/scan data acquisition mode for reliable identification and quantitation of pesticides in challenging food matrices with the Agilent 8890/7000E and 8890/7010C triple quadrupole GC/MS systems (GC/TQ). Simultaneous dMRM/scan mode eliminates the need to reanalyze the sample in each data acquisition mode separately. This mode enables retrospective analysis and demonstrates comparable performance for quantitation to dMRM only mode.

The data acquired in simultaneous dMRM/scan mode can serve several important functions including:

- Evaluation of the matrix in full scan
- Identification of the unknowns and retrospective analysis
- Confirmation of targets with the library match score
- Confirmation of targets with the MRM quantifier, qualifiers, and the retention time
- Quantitation using dMRM with sensitivity and dynamic range comparable to a conventional dMRM analysis.

This application note demonstrates the use of the acquired scan data for spinach, walnut, and cayenne pepper extracts for evaluating matrix blanks and performing screening based on spectral deconvolution with MassHunter Unknowns Analysis. The scan data allowed identifying compounds without established tolerances that may potentially be missed by the targeted GC/TQ dMRM method. Scan data were also used to confirm the identifications of the compounds with established tolerances included in the targeted dMRM method as was demonstrated with cayenne pepper. Finally, method sensitivity and calibration performance were comparable to those achieved with the conventional dMRM method making simultaneous dMRM/scan an attractive tool for reliable quantitation and compound identification within one analytical run.

References

1. Andrianova, A.; Quimby, B. Full Scan Quantitative Analysis of Semivolatile Organic Compounds. *Agilent Technologies application note*, publication number 5994-3859EN, **2021**.
2. Andrianova, A.; Quimby, B.; Westland, J. GC/MSD Pesticide Screening in Strawberries at Tolerance Levels Using Library Searching of Deconvoluted Spectra. *Agilent Technologies application note*, publication number 5994-0915EN, **2019**.
3. Andrianova, A.; Zhao, L. Five Keys to Unlock Maximum Performance in the Analysis of Over 200 Pesticides in Challenging Food Matrices by GC/MS/MS. *Agilent Technologies application note*, publication number 5994-4965EN, **2022**.
4. Pesticide Data Program. Annual Summary, Calendar Year **2016**. <https://www.ams.usda.gov/sites/default/files/media/2016PDPAnnualSummary.pdf>. Accessed on July 7th, 2022.
5. Index to Pesticide Chemical Names, Part 180 Tolerance Information, and Food and Feed Commodities (by Commodity), *US EPA*, December 12, **2012**. <https://www.epa.gov/sites/default/files/2015-01/documents/tolerances-commodity.pdf> Accessed on April 28th, 2022.

www.agilent.com

DE11973829

This information is subject to change without notice.

© Agilent Technologies, Inc. 2022
Printed in the USA, September 14, 2022
5994-4966EN

A Fast and Robust GC/MS/MS Analysis of 203 Pesticides in 10 Minutes in Spinach



Authors

Anastasia A. Andrianova,
Bruce D. Quimby,
and Limian Zhao
Agilent Technologies, Inc.

Abstract

This application note describes two approaches for achieving robust, multiresidue pesticide analysis in 10 minutes by GC/MS/MS, while maintaining sufficient chromatographic resolution for the analysis of over 200 pesticides in spinach; a challenging high chlorophyll, fresh matrix. First, the conventional 15 × 15 m (0.25 mm × 0.25 μm) midcolumn backflush configuration was used with an accelerated oven ramp, yielding an analysis time of 10 minutes. Second, a minibore 10 × 10 m (0.18 mm × 0.18 μm) midcolumn backflush configuration was used, enabling a fast 10-minute analysis time. The latter method was precisely scaled using the Agilent GC method translation technique. It was shown that midcolumn backflushing enabled method robustness and extended maintenance-free operation of the system by minimizing column trimming and source cleaning. Results demonstrate that the Agilent 7000E and 7010C triple quadrupole GC/MS systems delivered excellent linearity over a concentration range of 0.1 to 1,000 parts per billion (ppb). Method robustness was shown with 700 consecutive injections of a spinach extract, spiked with pesticides at 20 ppb, that spanned over 175 hours of continuous running of the GC/TQ.

Introduction

There is a growing demand for more rapid methods for the identification and quantitation of chemical residues in food analysis without sacrificing method robustness and chromatographic performance. Conventional methods for multiresidue pesticide analysis typically take at least 20 minutes, resulting in longer sample cycle times. As a result, the GC/MS analysis time for a batch of samples could easily span over several days. This causes a sample analysis bottleneck and limits lab productivity. Therefore, shortening the GC/MS analysis time will undoubtedly improve sample analysis throughput and eventually laboratory productivity. However, shortened GC methods usually involve trade-offs in method robustness or performance. This application note focuses on demonstrating two fast GC/MS/MS methods using (a) the **Agilent 8890 GC and 7000E** triple quadrupole GC/MS system and (b) the **Agilent 8890 GC and 7010C** triple quadrupole GC/MS system. The presented methods provide a shortened run time of 10 minutes, while maintaining robust system performance in the challenging spinach extract, without loss in sensitivity or method performance.

Two GC/TQ system midcolumn backflush configurations described in this application note provide analysis times of 10 minutes, while maintaining sufficient chromatographic resolution and MS selectivity for the analysis of 203 compounds. The conventional 20-minute GC/MS/MS method, retention time locked to the Agilent MassHunter pesticides and environmental pollutants MRM database (P&EP MRM database), was used as a benchmark for the optimized, fast analyses.

First, the conventional 15 × 15 m (0.25 mm × 0.25 μm) midcolumn backflush configuration was used with an accelerated oven ramp, yielding

an analysis time of 10 minutes. This configuration did not require any hardware changes. Second, a minibore 10 × 10 m (0.18 mm × 0.18 μm) midcolumn backflush configuration was used enabling a 10-minute analysis time. This configuration required a new set of columns when compared to the conventional 15 × 15 m setup and a GC oven insert (a pillow). However, the second configuration allowed for more accurate prediction of the retention times and preserved the elution order for all tested compounds.

With both fast methods, the retention times were accurately predicted using the retention times available in the P&EP MRM database.¹ Using the GC method translation technique and maintaining the same column phase ratio allowed for accurately predicting the retention times and maintaining elution order for the 203 analyzed pesticides with the 10 × 10 m configuration. To update the retention times for the 10-minute method with the conventional 15 × 15 m configuration, a combination of pesticides and n-alkanes were used.

Midcolumn backflushing with both column configurations improved method robustness by reducing the regular maintenance frequency, such as column head trimming and source cleaning. Also, when used with a temperature-programmable multimode inlet (MMI), the liner change and other inlet maintenance procedures can be conducted much more rapidly without cooling down and venting the MS source, compared to a conventional configuration with a column connecting the inlet directly to the mass spectrometer.

The developed methods were applicable for analyzing pesticides to cover the broad range of maximum residue limits (MRLs) for different pesticides in spinach and to deliver excellent calibration performance over a dynamic range of 0.1 to 1,000 ppb.

To evaluate method robustness, a test of 700 continuous injections of the spinach extract spiked with low-level pesticides was performed. Relative standard deviation (RSD) for the response of many challenging analytes was under 15% over 700 injections. There was no need to trim the column, clean the source, or tune the MS over the test. The maintenance was limited to liner and septum replacement every 100 injections.

Experimental

GC/TQ analysis

Two column configurations used with the 8890/7000E and 8890/7010C GC/TQ combinations are shown in Figure 1. The GC was configured with the Agilent 7693A automatic liquid sampler (ALS) and 150-position tray; an MMI, operated in temperature-programmed splitless injection mode (cold splitless); a midcolumn backflush capability provided by the Agilent purged Ultimate union (PUU), installed between two identical 15 or 10 m columns; and the 8890 GC pneumatic switching device (PSD) module. The instrument operating parameters are listed in Table 1. Data were acquired in dynamic MRM (dMRM) mode, which enables the capability for large multi-analyte assays and to accurately quantitate narrow peaks by an automated and most-efficient dwell time distribution.

The dMRM capability enabled a successful analysis for a large panel of 203 pesticides with 614 total MRM transitions. The maximum number of concurrent MRM transitions with the conventional 15 × 15 m configuration and a traditional 20-minute analysis was 52. For the 10-minute analysis, the maximum number of concurrent MRM transitions with the conventional 15 × 15 m and the minibore 10 × 10 m configurations were 127 and 83, respectively (Figure 2). Furthermore, dMRM enables the analyst to add and

remove additional analytes with ease. The use of the P&EP MRM database increased the ease and speed of setting up a targeted dMRM method.

Agilent MassHunter Workstation revisions 10.1 and 10.2 including MassHunter Acquisition software for GC/MS systems 10.2, MassHunter Quantitative Analysis software 10.1, and MassHunter Qualitative Analysis software 10 packages were used in this work.

Calibration performance was evaluated using a series of matrix-matched calibration standards ranging from 0.1 to 1,000 ppb, including 0.1, 0.5, 1, 5, 10, 50, 100, 250, 500, and 1,000 ppb (w/v). The GC multiresidue pesticide kit containing 203 compounds (Restek, Bellefonte, PA, USA), regulated by the FDA, USDA, and other global governmental agencies, was used for preparing matrix-matched calibration standards. α -BHC-d6, at a final concentration of 20 ppb in vial,

was used as the internal standard for quantitation of the target pesticides (Agilent Bond Elut QuEChERS IS standard number 6; part number PPS-610-1). A weighting factor of 1/x was applied to all calibration curves.

Retention time locking the 10-minute methods

Retention time locking allows a new column or instrument to have retention times that match the MRM database or an existing method exactly, allowing methods to be easily ported from one instrument to another and across instruments globally. This simplifies method maintenance and system setup. The retention times for the conventional 20-minute pesticide analysis are provided in the P&EP MRM database. The same GC column flow at which the 20-minute analysis was locked to the P&EP MRM database was used with the 10-minute method with the conventional 15 x 15 m configuration. This resulted

in the new locking retention time for chlorpyrifos-methyl at 5.520 minutes. To update the retention times for the rest of the analytes, a combination of pesticides and n-alkanes were used to predict retention times for the new method based on the retention times for a 20-minute method from the P&EP MRM database.

The 10-minute analysis using the minibore 10 x 10 m configuration was precisely scaled using the method translation tool, providing a speed gain of 2. The fine tuning of the method enabled the best match between predicted and observed retention times across the elution range of 203 pesticides, which resulted in the 0.09 minutes offset. New retention times (RT) were calculated using the following equation:

$$RT_{\text{new}} = RT_{\text{old}}/2 + 0.09 \text{ minutes.}$$

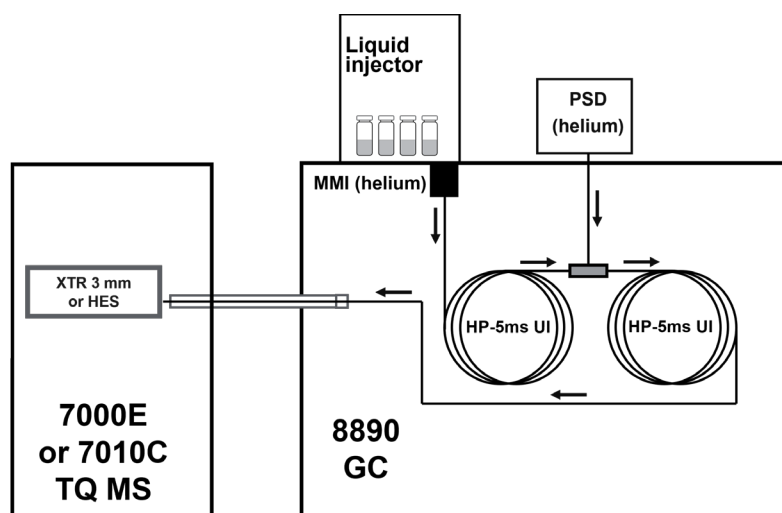

Conventional 15 x 15 m midcolumn backflush configuration:

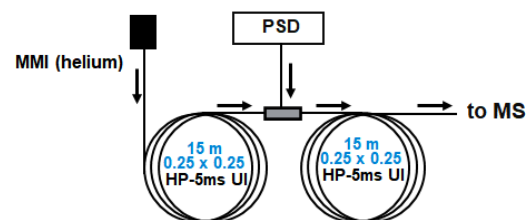

Narrow bore 10 x 10 m midcolumn backflush configuration:

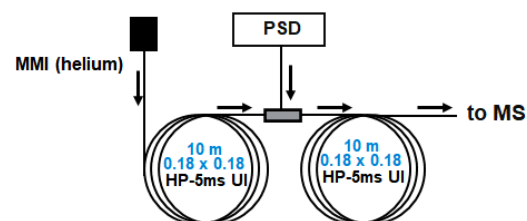

Figure 1. The Agilent GC/TQ system featuring two utilized midcolumn backflush configurations (right).

Table 1. Agilent 8890 GC and 7000 Series GC/TQ and the Agilent 8890 GC and 7010C GC/TQ system conditions enabling 10-minute pesticide analysis.

GC		Column 1			MSD		
Agilent 8890 GC (220 V oven) with fast oven, auto injector, and tray		With 15 × 15 m		With 10 × 10 m		Agilent 7000 series (7000D and 7000E) or 7010C triple quadrupole GC/MS	
Inlet	Multimode inlet (MMI)	Type	Agilent J&W HP-5ms Ultra Inert	Type	Agilent J&W HP-5ms Ultra Inert	Source	Inert Extractor Source with a 3 mm lens or HES
Mode	Cold splitless	Agilent Part Number	19091S-431UI-KEY	Agilent Part Number	19091S-571UI	Vacuum Pump	Performance turbo
Purge Flow to Split Vent	60 mL/min at 0.75 min	Length	15 m	Length	10 m	Tune File	Atunes.eiex.jtune.xml or Atunes.eihs.jtune.xml
Septum Purge Flow	3 mL/min	Diameter	0.25 mm	Diameter	0.18 mm	Solvent Delay	3 min
Septum Purge Flow Mode	Switched	Film Thickness	0.25 µm	Film Thickness	0.18 µm	Quad Temperature (MS1 and MS2)	150 °C
Injection Volume	1.0 µL	Control Mode	Constant flow	Control Mode	Constant flow	Source Temperature	280 °C
Injection Type	Standard	Flow	1.016 mL/min	Flow	1.3 mL/min	Mode	dMRM
L1 Airgap	0.2 µL	Inlet Connection	Multimode inlet (MMI)	Inlet Connection	Multimode inlet (MMI)	He Quench Gas	2.25 mL/min
Gas Saver	On at 30 mL/min after 3 min	Outlet Connection	PSD (PUU)	Outlet Connection	PSD (PUU)	N ₂ Collision Gas	1.5 mL/min
Inlet Temperature	60 °C for 0.1 min, then to 280 °C at 600 °C/min	PSD Purge Flow	5 mL/min	PSD Purge Flow	5 mL/min	MRM Statistics	
Post Run Inlet Temperature	310 °C	Post Run Flow (Backflushing)	-7.873	Post Run Flow (Backflushing)	-3.174		
Post Run Total Flow	25 mL/min	Column 2					
Carrier Gas	Helium	With 15 × 15 m		With 10 × 10 m			
Inlet Liner	Agilent Ultra Inert 2 mm dimpled liner	Type	Agilent J&W HP-5ms Ultra Inert	Type	Agilent J&W HP-5ms Ultra Inert	Total MRMs (dMRM Mode)	614 614
Inlet Liner Part Number	5190-2297	Agilent Part Number	19091S-431UI-KEY	Agilent Part Number	19091S-571UI	Minimum Dwell Time	2.33 ms 3.99 ms
Oven		Length	15 m	Length	10 m	Minimum Cycle Time	167.86 ms 110.38 ms
	With 15 × 15 m	Diameter	0.25 mm	Diameter	0.18 mm	Maximum Concurrent MRMs	127 83
Initial Oven Temperature	60 °C	Film Thickness	0.25 µm	Film Thickness	0.18 µm	EM Voltage Gain Mode	10 10
Initial Oven Hold	1 min	Control Mode	Constant flow	Control Mode	Constant flow		
Ramp Rate 1	80 °C/min	Flow	1.216 mL/min	Flow	1.5 mL/min		
Final Temp 1	170 °C	Inlet Connection	PSD (PUU)	Inlet Connection	PSD (PUU)		
Final Hold 1	0 min	Outlet Connection	MSD	Outlet Connection	MSD		
Ramp Rate 2	35 °C/min	Post Run Flow (Backflushing)	8.202	Post Run Flow (Backflushing)	3.290		
Final Temp 2	310 °C						
Final Hold 2	3.625 min						
Total Run Time	10 min						
Post Run Time	1.5 min						
Equilibration Time	0.25 min						
							High-speed oven insert (pillow)

Sample preparation

A sample preparation workflow chart is shown in Figure 3. The sample preparation included two major steps: sample extraction by traditional QuEChERS extraction, followed by Captiva enhanced matrix removal (EMR) pass-through cleanup. The Agilent Captiva EMR-High Chlorophyll Fresh with NH_2 (Captiva EMR-HCF1) cartridge was used for high chlorophyll fresh matrix (spinach). The new sample preparation workflow demonstrates as a simplified procedure with improvement on both sample matrix removal and targets quantitation data quality.

As shown in Figure 3, samples were first extracted using the traditional Agilent Bond Elut QuEChERS EN extraction kit (part number 5982-5650CH). Homogenized fresh spinach (10 g) was used for extraction. The 10 mL of ACN with 1% acetic acid was then added, followed by extraction. After extraction, 3 mL of crude extract was transferred to a Captiva EMR-HCF1 cartridge (part number 5610-2088) for pass-through cleanup. The sample eluent was collected and further dried by anhydrous MgSO_4 (part number 5982-0102). Samples were then ready for GC/TQ analysis. The Agilent positive pressure manifold 48 processor (PPM-48; part number 5191-4101) was used for Captiva EMR pass-through cleanup processing.

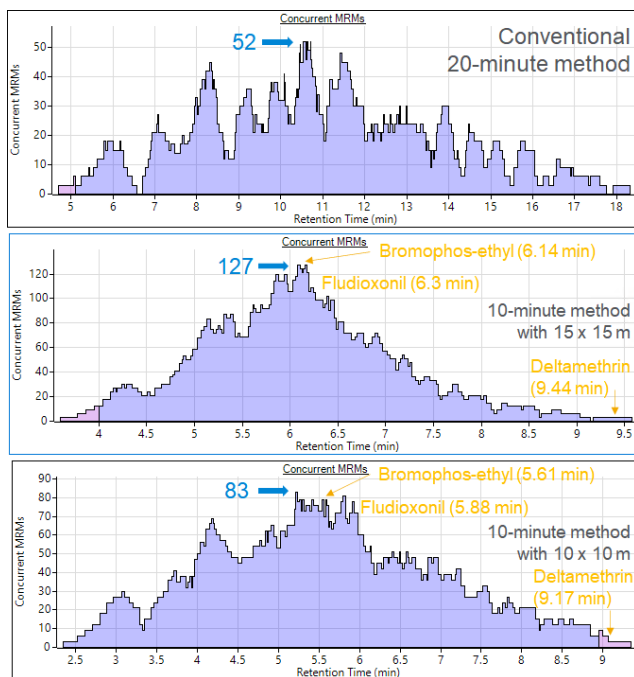

Figure 2. The distribution of 614 dMRM transitions with the 20-minute conventional pesticide analysis, the 10-minute analysis employing the conventional 15 × 15 m configuration, and the 10-minute method employing the minibore 10 × 10 m column configuration.

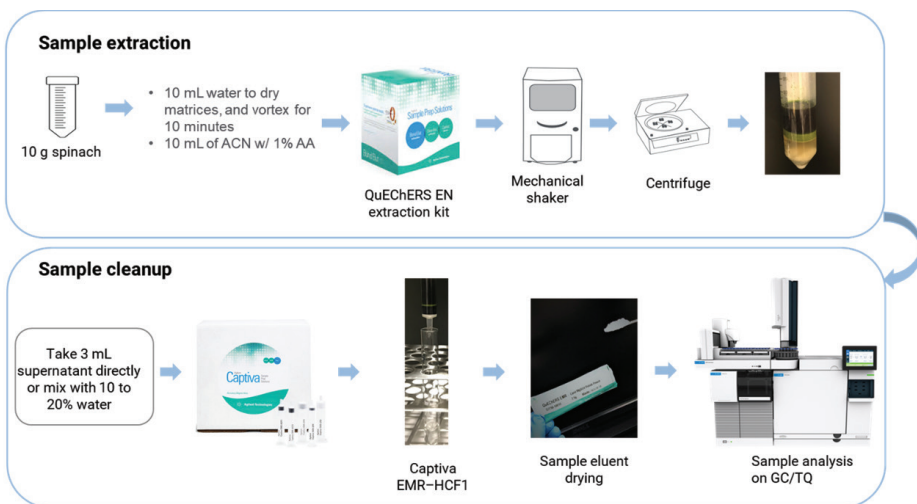

Figure 3. Sample preparation flowchart including traditional Agilent QuEChERS extraction, followed by Agilent Captiva EMR pass-through cleanup.

Results and discussion

Maintaining chromatographic resolution with the 10-minute analysis of over 200 pesticides

The presented GC midcolumn backflush configurations, including the conventional 15 × 15 m and the minibore 10 × 10 m configurations, enabled the 10-minute analysis of 203 pesticides with three MRM transitions acquired per each compound. Figure 4 demonstrates that the chromatographic resolution with the fast, 10-minute method was largely maintained with the conventional 15 × 15 m setup (Figure 4A) and completely preserved with the minibore 10 × 10 m setup (Figure 4B). The GC method translation technique used for transferring the method to the 10 × 10 m configuration allowed for preserving the relative elution order of the compounds.

Sensitivity and calibration performance over a wide dynamic range with the 10-minute separations

The method sensitivity achieved with the different column configurations and 10-minute separations was comparable to that observed with the conventional 20-minute method. Both 10-minute methods with the 15 × 15 m and the 10 × 10 m column configurations allowed for detecting all the targeted

pesticides below their regulated MRLs, even for the most challenging ones. For example, deltamethrin, a challenging compound for GC/MS, was shown to be accurately quantitated in spinach down to 0.1 ppb with the 7010C GC/TQ and 1 to 5 ppb with the 7000 series GC/TQ (Figure 5A). While deltamethrin does not have an established MRL in spinach, it is regulated in many other food commodities including vegetable groups 8 and 9, and subgroups IB and IC, with the MRLs at 40 to 300 ppb.² The observed calibration ranges with the 7010 GC/TQ and the 7000 series GC/TQ would allow analysts to meet their analytical needs for the analysis of deltamethrin in various food matrices.

While deltamethrin is known to be challenging for GC/MS analysis, its elution at the end of the 10-minute analysis results in few concurrent MRM transitions. With only a few concurrent MRM transitions, the MRMs monitored for deltamethrin have relatively long dwell times (above 50 ms) even with the fast 10-minute methods (Figure 2). On the contrary, fludioxonil, a fungicide with an established MRL of 10 ppb in spinach³, elutes during the crowded segment of the MRM methods with 120 and 80 concurrent MRM transitions in the 15 × 15 m method and the 10 × 10 m method configurations,

respectively. Despite relatively short dwell times of 3 and 4.9 ms with the two configurations, fludioxonil was accurately quantitated down to 0.1 ppb with both the 7010C and the 7000 series GC/TQ systems with at least ten data points across the peak (Figure 5B). The 7010C GC/TQ equipped with the high efficiency source (HES) demonstrated superior sensitivity compared to the 7000 series GC/TQ. It allows for accurate quantitation below 0.1 ppb, even though this was not required in this work, as the MRLs for pesticides regulated in most food commodities by US EPA do not require sub-0.1 ppb quantitation. Similarly, bromophos-ethyl eluted in a crowded retention time window with a high number of concurrently monitored MRM transitions, leading to a short dwell time of 2.7 and 4.7 ms with the 15 × 15 m and the 10 × 10 m configurations, respectively. Bromophos-ethyl has recommended tolerances ranging from 20 to 2,000 ppb in various commodities.⁴ Figures 5B and 5C demonstrate that fludioxonil and bromophos-ethyl were accurately quantitated over the wide concentration range of 0.1 to 1,000 ppb with excellent sensitivity and linearity in the challenging spinach matrix and at least nine data points across the peak.

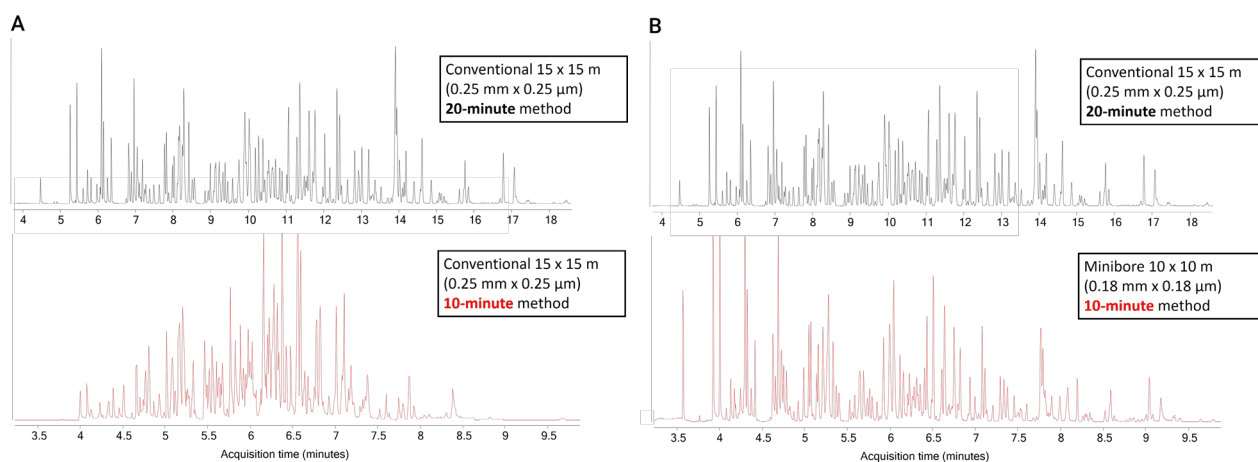
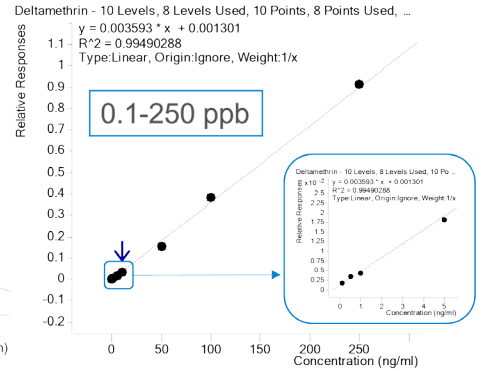
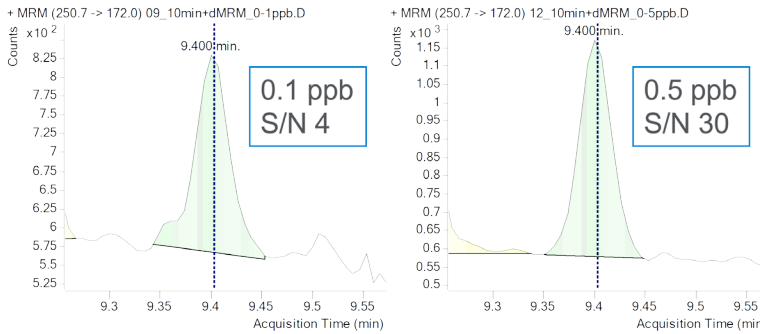

Figure 4. MRM total ion current chromatograms (TIC) of a mixture of 203 pesticides acquired with (A) the conventional 15 × 15 m configuration and (B) with the minibore 10 × 10 m configuration.

A) Deltamethrin

7010C
15 x 15 m



7000E
15 x 15 m

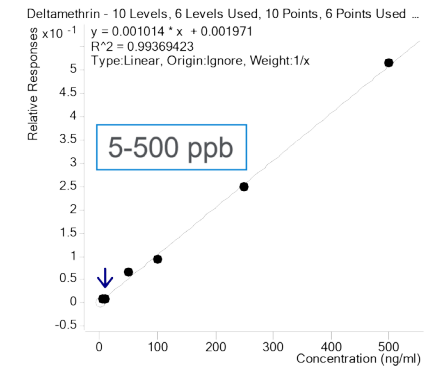
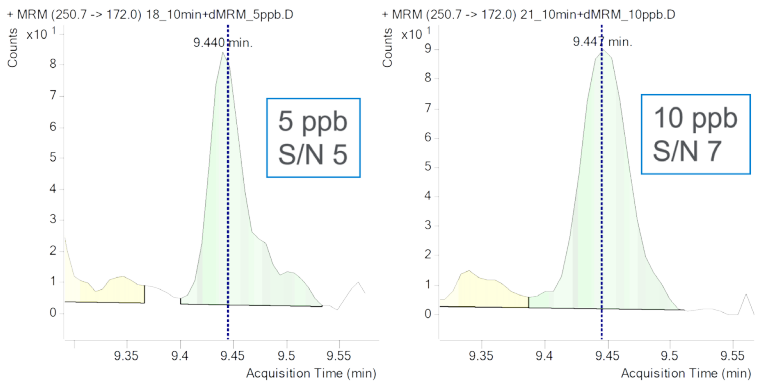

7000 series
10 x 10 m

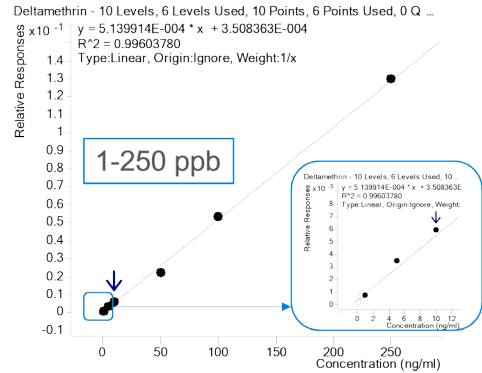
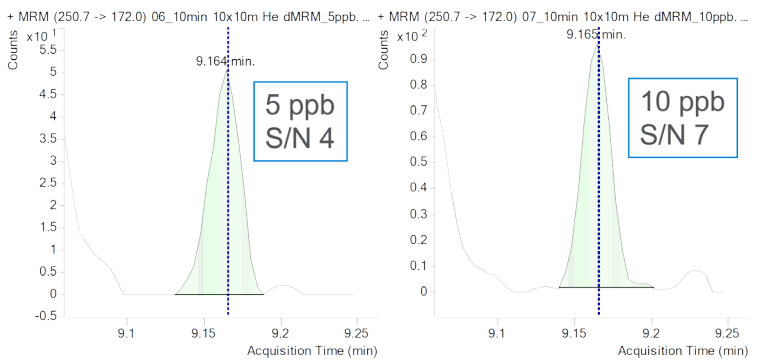

B) Fludioxonil

7010C
15 x 15 m

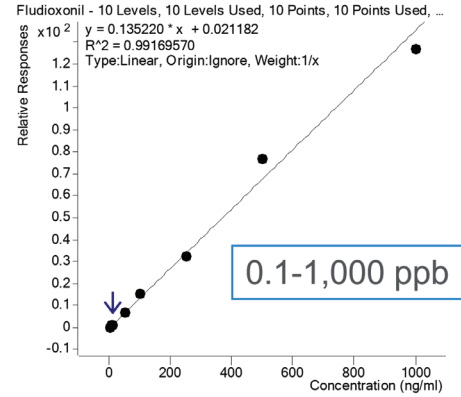
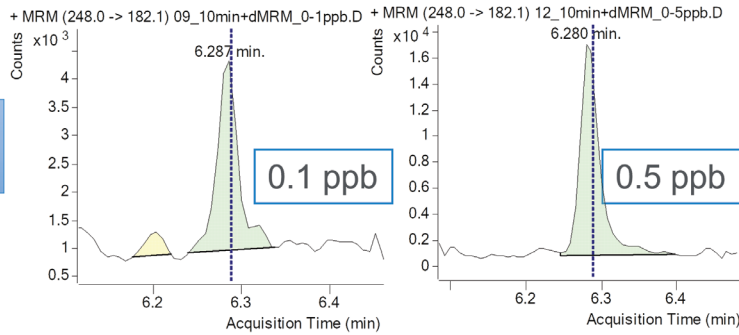

7000E
15 x 15 m

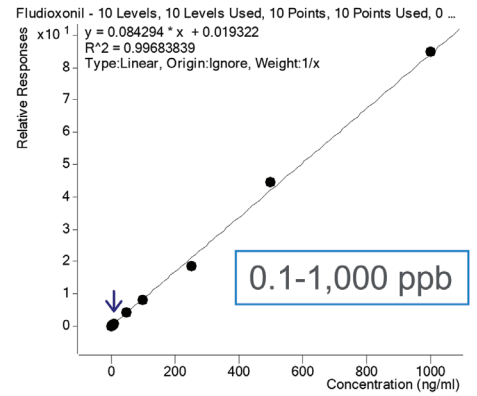
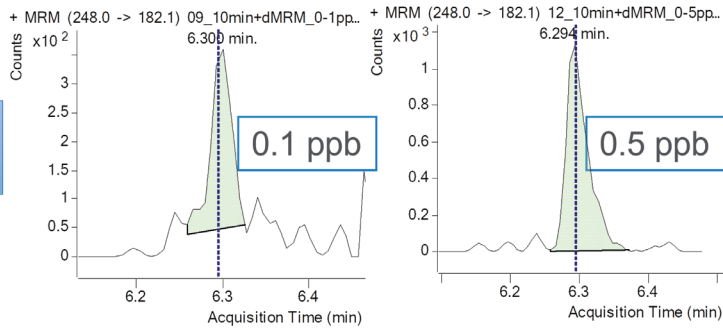

7000 series
10 x 10 m

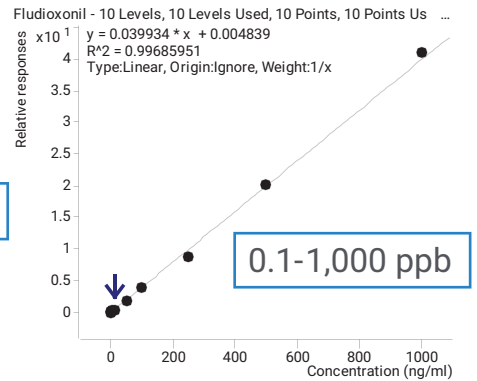
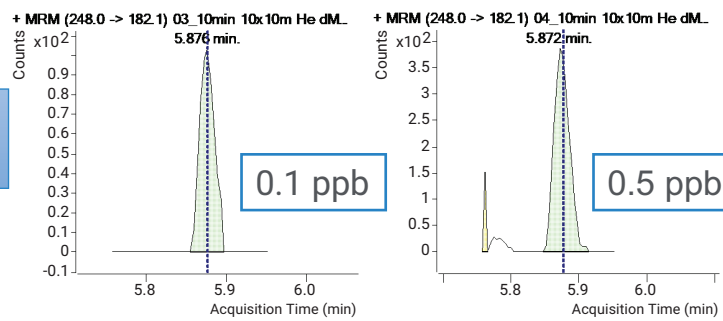

C) Bromophos-ethyl

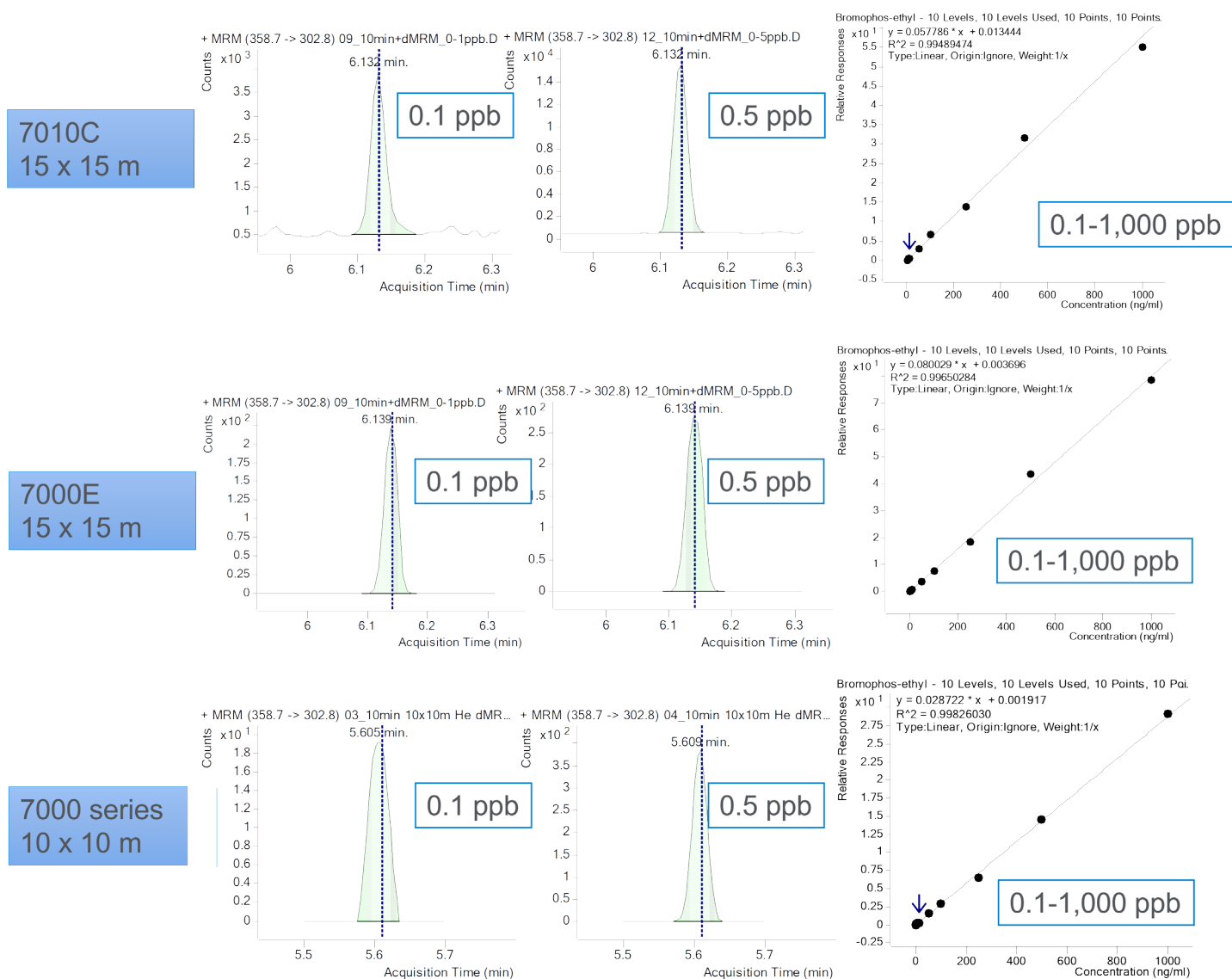

Figure 5. MRM chromatograms and matrix-matched calibration curves in spinach for (A) deltamethrin, (B) fludioxonil, and (C) bromophos-ethyl observed with different column configurations and 10-minute separations using the Agilent 7010C and 7000 series triple quadrupole GC/MS systems.

The biggest challenge with multiresidue pesticide analysis is that the MRLs established for pesticides in different food commodities vary significantly. This may require undesirable sample re-injection if the method calibration ranges do not encompass all the MRLs for the compounds of interest. A broad dynamic calibration range is desirable to use the more generic quantitation method for analyzing different pesticides in the commodity and for various foods

and to simplify the sample pretreatment before instrument detection, such as further dilution. Figure 6 summarizes the calibration performance for the 203 pesticides that were analyzed in spinach with the 10-minute separations using the conventional 15 × 15 m configuration coupled with the 7010C and the 7000E GC/TQ, and the minibore 10 × 10 m configuration coupled with the 7000 series GC/TQ. The graph shows the number of compounds with the

calibration correlation coefficient $R^2 > 0.99$, using the different regression fit (linear or quadratic), within the different calibration ranges.

Most of the target compounds demonstrated linear calibration curves over a wide range of either 0.1 to 1,000 ppb or 0.5 to 1,000 ppb, enabling their reliable quantitation at the varying MRLs established for different compounds.

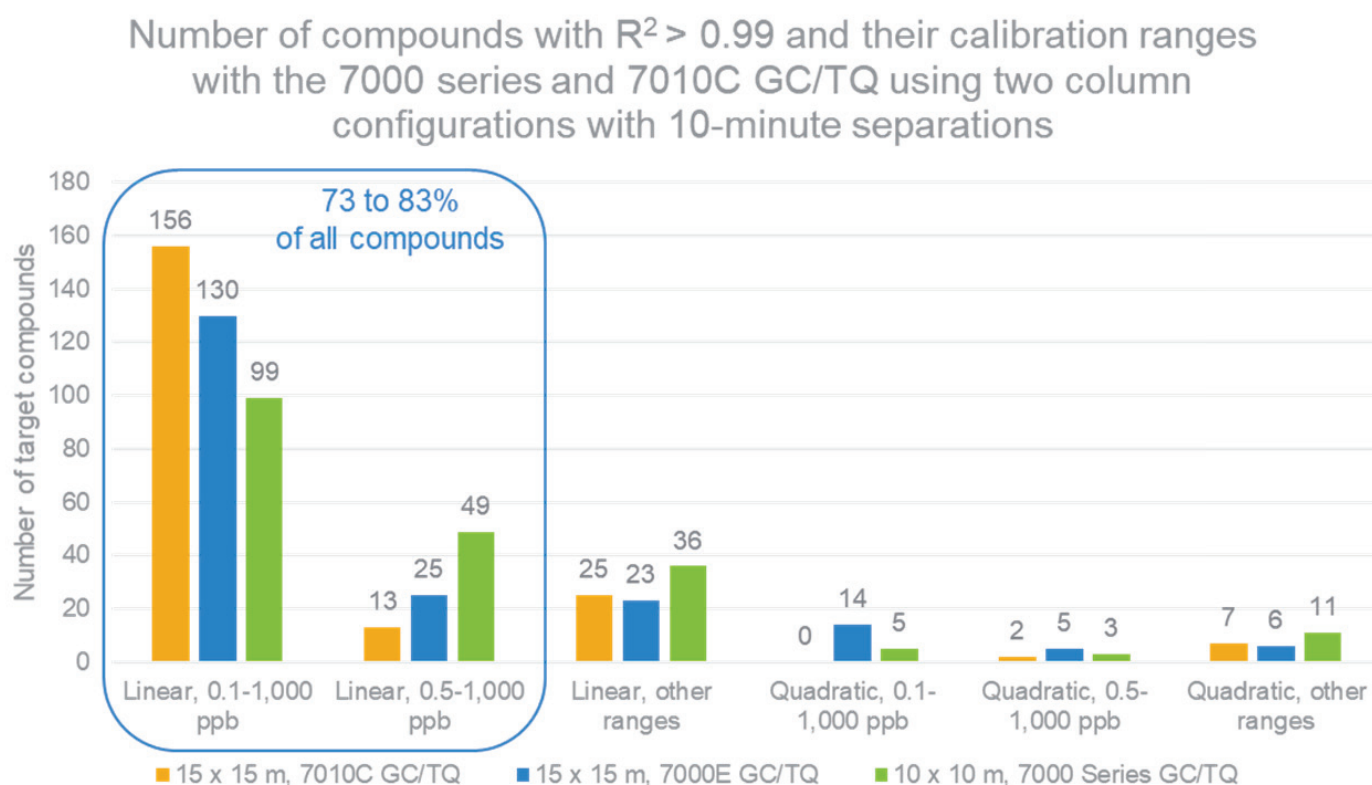

Figure 6. Calibration performance for the 203 pesticides with the 10-minute methods using the conventional 15 × 15 m configuration, coupled with the Agilent 7010C and 7000E triple quadrupole GC/MS systems, and the minibore 10 × 10 m configuration, coupled with the Agilent 7000 series triple quadrupole GC/MS in spinach. The graph shows the number of compounds and their calibration ranges.

Method robustness with 700 injections of a spinach extract

The robustness of the 10-minute analysis was demonstrated by analyzing a challenging, highly pigmented spinach extract spiked with pesticides at 20 ppb. The area of the analytes was monitored over 700 consecutive injections. Analyte response, normalized by the internal standards (ISTD), remained consistent over 700 injections that spanned over 175 hours of continuous running with the 10-minute method, using the conventional 15 × 15 m column configuration coupled with the 7000E GC/TQ. The only maintenance procedure performed during the robustness testing involved septum and liner replacement every 100 injections.

There was no need to perform inlet cleaning, GC column trimming, or MS source cleaning, or retune the MS during the entire study that involved over 1,000 injections (robustness testing over 700 runs and additional analyses performed for system evaluation and calibration).

The keys to successful and robust pesticide analysis that enables stable GC/TQ performance for over 700 injections are described in the application note 5994-4965EN.⁵ The best practices used in this work included:

- Simplified and improved sample preparation achieved with the novel and improved Captiva EMR pass-through cleanup following traditional QuEChERS extraction

- Evaluation of in-source loading of the matrix in full scan data acquisition mode
- Postrun backflushing enabled with the conventional 15 × 15 m and the minibore 10 × 10 m midcolumn backflush configurations
- Leak-free GC/TQ system enabled with the self-tightening collared column nuts and CFT gold-plated flexible metal ferrules
- Use of temperature-programmed MMI with a 2 mm Ultra Inert dimpled liner (no glass wool)

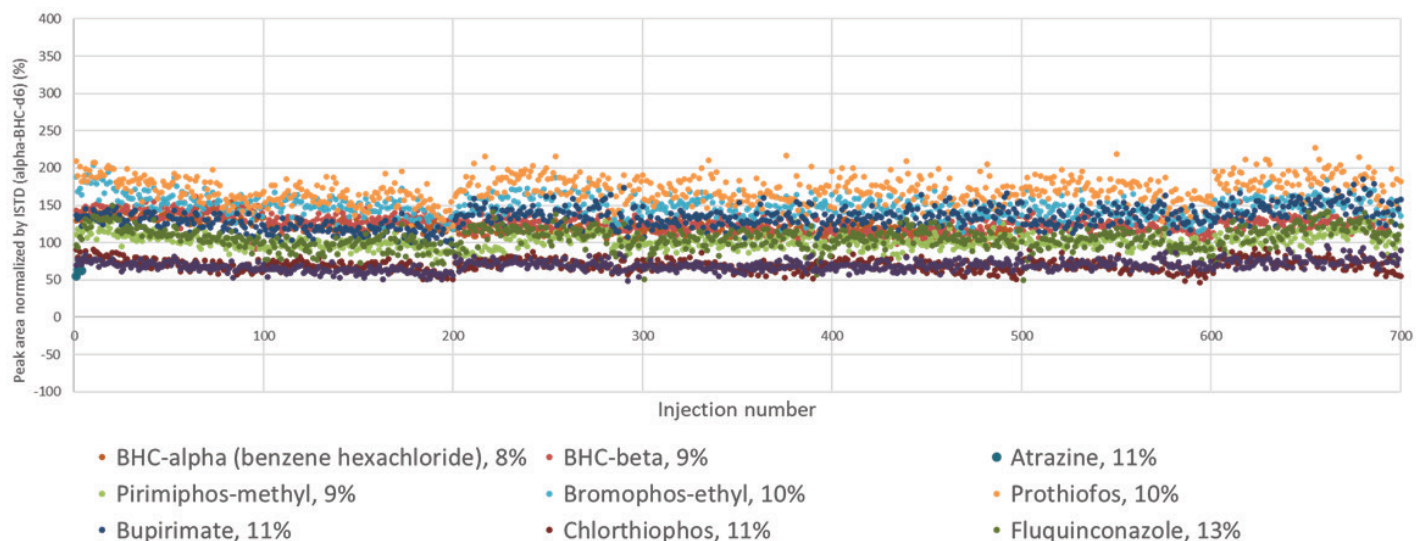

Figure 7. Stability of the peak area for pesticides spiked at 20 ppb into spinach extract, normalized by the ISTD, over 700 consecutive injections. The 10-minute analysis using the conventional 15 × 15 m column configuration coupled with the Agilent 7000E triple quadrupole GC/MS.

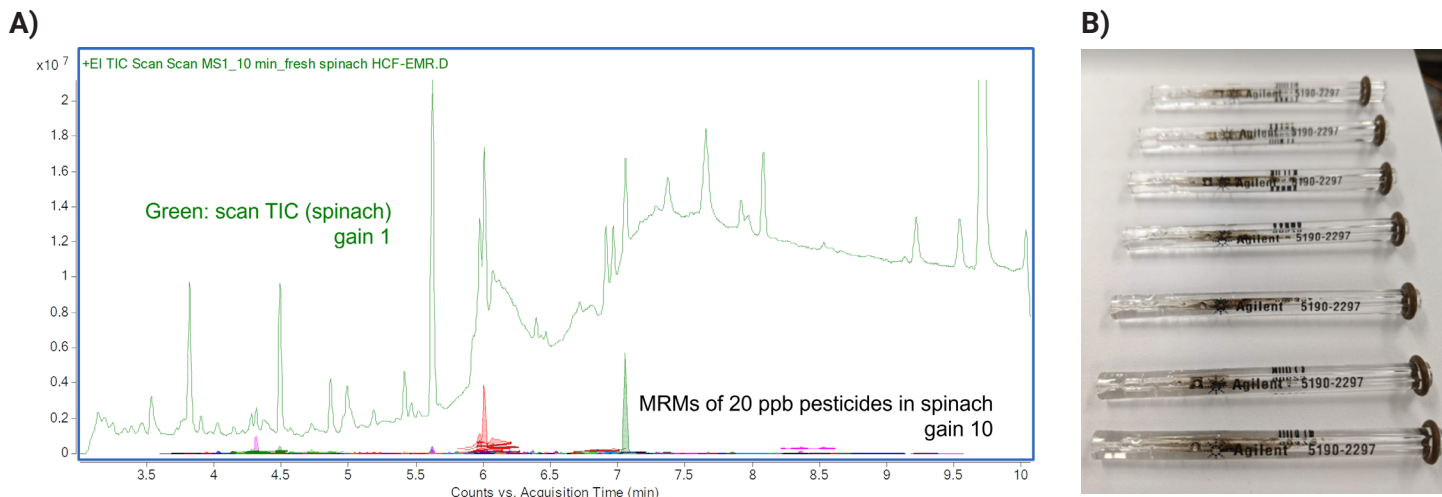

Figure 8. (A) TIC of a full scan chromatogram acquired for spinach extract and the MRM TIC for 20 ppb pesticides. (B) The GC inlet liners replaced after 100 injections when analyzing spinach extract during the robustness evaluation.

Highly pigmented spinach extract selected for the robustness testing was demonstrated to have a relatively high background in full scan data acquisition mode, as shown in Figure 8A, compared to the abundance of the MRM signal for pesticides at 20 ppb. The liners replaced after 100 injections, seven times during the robustness study, are shown in Figure 8B. This indicates that spinach extract truly presents a challenge for GC/MS analysis, hence, served as a suitable matrix for robustness performance evaluation.

Conclusion

This application note described two GC/TQ system configurations using midcolumn backflush that both enable robust pesticide analysis in 10 minutes, while maintaining sufficient chromatographic resolution for 203 compounds. The conventional $15 \times 15 \text{ m}$ ($0.25 \text{ mm} \times 0.25 \text{ }\mu\text{m}$) and the minibore $10 \times 10 \text{ m}$ ($0.18 \text{ mm} \times 0.18 \text{ }\mu\text{m}$) midcolumn backflush configurations

were used to achieve a 10-minute analysis time. Results demonstrate that excellent linearity, over a calibration dynamic range of 0.1 to 1,000 ppb or 0.5 to 1,000 ppb, was achieved with the Agilent 7010C and 7000 series triple quadrupole GC/MS systems. Method robustness was shown with 700 consecutive injections of spinach extract spiked with pesticides at 20 ppb.

References

1. The Agilent MassHunter pesticide and environmental pollutants MRM database (P&EP 4.0). G9250AA. <https://www.agilent.com/en/product/gas-chromatography-mass-spectrometry-gc-ms/gc-ms-application-solutions/gc-ms-ms-pesticides-analyzer>
2. 40 CFR § 180.435 - Deltamethrin; tolerances for residues. [https://www.law.cornell.edu/cfr/text/40/180.435#:~:text=\(2\)%20A%20tolerance%20of%200.05,establishments%20or%20as%20a%20wide](https://www.law.cornell.edu/cfr/text/40/180.435#:~:text=(2)%20A%20tolerance%20of%200.05,establishments%20or%20as%20a%20wide). Accessed on April 22nd, 2022.
3. Index to Pesticide Chemical Names, Part 180 Tolerance Information, and Food and Feed Commodities (by Commodity), US EPA. December 12, 2012. <https://www.epa.gov/sites/default/files/2015-01/documents/tolerances-commodity.pdf>. Accessed on April 28th, 2022
4. IPCS INCHEM. <https://inchem.org/documents/jmpr/jmpmono/v072pr04.htm>. Accessed on April 28th, 2022.
5. Andrianova, A; Zhao, L. Five Keys to Unlock Maximum Performance in the Analysis of Over 200 Pesticides in Challenging Food Matrices by GC/MS/MS, *Agilent Technologies application note*, publication number 5994-4965EN, **2022**.

Appendix 1

Compounds analyzed in this work and their observed retention times with two-column configurations and 10-minute separations.

Name	Retention Time (min)		Name	Retention Time (min)	
	15 × 15 m	10 × 10 m		15 × 15 m	10 × 10 m
Allidochlor	3.773	2.542	BHC-gamma (Lindane, gamma HCH)	5.201	4.174
Dichlorobenzonitrile, 2,6-	3.972	2.720	Pyrimethanil	5.222	4.246
Biphenyl	4.055	2.812	Tefluthrin	5.223	4.310
Mevinphos, E-	4.110	2.901	Fonofos	5.225	4.223
3,4-Dichloroaniline	4.193	2.954	Pentachloronitrobenzene	5.227	4.210
Pebulate	4.223	3.006	Pentachlorobenzonitrile	5.247	4.228
Etridiazole	4.246	3.016	Disulfoton	5.273	4.312
N-(2,4-dimethylphenyl)formamide	4.305	3.091	Isazofos	5.285	4.361
cis-1,2,3,6-Tetrahydrophthalimide	4.312	3.090	Terbacil	5.285	4.323
Methacrifos	4.321	3.129	Triallate	5.322	4.379
Chloroneb	4.375	3.171	BHC-delta	5.330	4.351
2-Phenylphenol	4.444	3.228	Chlorothalonil	5.350	4.392
Pentachlorobenzene	4.495	3.276	Propanil	5.463	4.570
Propachlor	4.702	3.546	Endosulfan ether	5.466	4.523
Tecnazene	4.712	3.547	Transfluthrin	5.476	4.658
Diphenylamine	4.734	3.582	Dimethachlor	5.477	4.596
Cycloate	4.757	3.626	Pentachloroaniline	5.482	4.552
Chlorpropham	4.769	3.656	Acetochlor	5.502	4.641
2,3,5,6-Tetrachloroaniline	4.793	3.633	Vinclozolin	5.503	4.654
Trifluralin	4.798	3.724	Parathion-methyl	5.526	4.668
Benfluralin	4.811	3.740	Chlorpyrifos-methyl	5.526	4.668
Ethalfuralin	4.812	3.670	Tolclofos-methyl	5.559	4.710
Sulfotep	4.869	3.789	Alachlor	5.564	4.725
Diallate I	4.928	3.846	Propisochlor	5.579	4.765
Phorate	4.932	3.852	Metalaxyl	5.583	4.763
BHC-beta	5.010	4.115	Ronnel	5.614	4.791
BHC-alpha (benzene hexachloride)	5.011	3.918	Prodiamine	5.622	4.871
Hexachlorobenzene	5.069	3.987	Heptachlor	5.630	4.763
Atrazine	5.072	4.048	Pirimiphos-methyl	5.650	4.892
Dichloran	5.072	3.998	Fenitrothion	5.676	4.891
Pentachloroanisole	5.083	4.013	Malathion	5.696	4.962
Clomazone	5.122	4.092	Linuron	5.708	4.927
Profluralin	5.123	4.156	Dichlofluanid	5.745	4.980
Terbutylazine	5.155	4.163	Pentachlorothioanisole	5.767	4.972
Terbufos	5.173	4.178	Aldrin	5.768	5.061
Propyzamide	5.175	4.188	Fenthion	5.779	5.057
Diazinon	5.191	4.244	Metolachlor	5.783	5.046
Fluchloralin	5.199	4.261	Chlorpyrifos	5.790	5.075

Name	Retention Time (min)		Name	Retention Time (min)	
	15 × 15 m	10 × 10 m		15 × 15 m	10 × 10 m
Parathion	5.793	5.081	Chlorfenson	6.275	5.784
Triadimefon	5.811	5.100	Nonachlor, trans-	6.279	5.787
DCPA (Dacthal, Chlorthal-dimethyl)	5.829	5.124	Dieldrin	6.279	5.955
Anthraquinone	5.831	5.053	Fludioxonil	6.294	5.876
Dichlorobenzophenone, 4,4'-	5.840	5.110	Prothiofos	6.300	5.844
Pirimiphos-ethyl	5.869	5.241	Oxadiazon	6.303	5.920
MGK-264	5.881	5.315	Pretilachlor	6.303	5.895
Isopropalin	5.898	5.267	Iodofenphos	6.304	5.828
Fenson	5.902	5.194	Profenofos	6.312	5.877
Diphenamid	5.908	5.235	Oxyfluorfen	6.314	5.960
Bromophos	5.918	5.237	DDE-p,p'	6.342	5.906
Cyprodinil	5.941	5.314	Bupirimate	6.361	6.014
Pendimethalin	5.975	5.356	Myclobutanil	6.364	5.970
Chlozolinate	5.976	5.378	Chlorfenapyr	6.365	6.122
Allethrin	5.979	5.393	Flusilazole	6.370	5.995
Triflumizole	5.979	5.473	Fluazifop-p-butyl	6.388	6.090
Fipronil	5.993	5.431	DDD-o,p'	6.404	5.990
Penconazole	5.998	5.375	Tricyclazole	6.412	5.932
Metazachlor	5.999	5.358	Endrin	6.423	6.153
Chlorfenvinphos	6.016	5.436	Ethylan	6.453	6.121
Heptachlor exo-epoxide	6.016	5.402	Nitrofen	6.477	6.101
Isodrin	6.018	5.319	Chlorobenzilate	6.506	6.189
Captan	6.020	5.472	Ethion	6.571	6.315
Tolyfluanid	6.026	5.413	DDD-p,p'	6.582	6.280
Bromfenvinfos-methyl	6.036	5.436	DDT-o,p'	6.582	6.318
Quinalphos	6.047	5.463	Chlorthiophos	6.587	6.338
Triadimenol	6.053	5.476	Endosulfan II (beta isomer)	6.603	6.235
Procymidone	6.090	5.515	Triazophos	6.644	6.428
Folpet	6.127	5.513	Sulprofos	6.659	6.420
Paclobutrazol	6.137	5.653	Nonachlor, cis-	6.667	6.341
Chlorbenside	6.137	5.549	Carfentrazone-ethyl	6.668	6.509
Bromophos-ethyl	6.139	5.609	Methoxychlor olefin	6.702	6.519
DDE-o,p'	6.176	5.631	Endrin aldehyde	6.709	6.402
Tetrachlorvinphos	6.181	5.680	Carbophenothion	6.726	6.513
Chlordane-trans	6.187	5.610	Norflurazon	6.754	6.576
Chlordane-cis	6.196	5.744	Edifenphos	6.786	6.566
Fenamiphos	6.227	5.797	Lenacil	6.787	6.588
Flutolanil	6.233	5.801	DDT-p,p'	6.805	6.615
Bromfenvinfos	6.252	5.800	Iprodione	6.826	6.947
Flutriafol	6.255	5.764	Methoxychlor, o,p'-	6.846	6.703
Endosulfan I (alpha isomer)	6.274	5.724	Endosulfan sulfate	6.852	6.610

Name	Retention Time (min)		Name	Retention Time (min)	
	15 × 15 m	10 × 10 m		15 × 15 m	10 × 10 m
Piperonyl butoxide	6.854	6.788	Acrinathrin	7.415	7.607
Propargite	6.856	6.760	Leptophos	7.417	7.413
Resmethrin	6.857	6.756	Pyrazophos	7.556	7.660
Hexazinone	6.861	6.708	Fenarimol	7.631	7.641
Tebuconazole	6.886	6.739	Mirex	7.636	7.533
Captafol	6.890	6.805	Pyraclufos	7.645	7.728
Nitralin	6.913	6.862	Azinphos-ethyl	7.675	7.700
Bifenthrin	7.044	7.057	Permethrin, (1R)-cis-	7.785	7.901
Pyridaphenthion	7.048	7.004	Permethrin, (1R)-trans-	7.842	7.962
Tetramethrin I	7.052	6.999	Pyridaben	7.916	7.980
Fenpropathrin	7.106	7.121	Coumaphos	7.964	8.028
Bromopropylate	7.109	7.061	Fluquinconazole	7.964	8.023
EPN	7.112	7.061	Prochloraz	7.988	8.058
Tebuufenpyrad	7.130	7.152	Cyfluthrin I	8.157	8.184
Methoxychlor, p,p'-	7.131	7.111	Cypermethrin I	8.250	8.339
Phosmet	7.135	7.054	Flucythrinate I	8.359	8.444
Endrin ketone	7.189	7.033	Acequinocyl	8.409	8.534
Phenothrin I	7.230	7.243	Ethofenprox	8.431	8.485
Azinphos-methyl	7.330	7.405	Fluridone	8.708	8.662
Tetradifon	7.330	7.305	Fenvalerate I	8.881	8.799
Cyhalothrin (Lambda)	7.334	7.438	Fluvalinate-tau I	8.970	8.894
Pyriproxyfen	7.358	7.406	Deltamethrin	9.444	9.166
Phosalone	7.389	7.387			

www.agilent.com

DE13474802

This information is subject to change without notice.

© Agilent Technologies, Inc. 2022, 2023
 Printed in the USA, February 2, 2023
 5994-4967EN

Analysis of Pesticides in Kale Using the Agilent 7010C Triple Quadrupole GC/MS with Agilent Bond Elut QuEChERS High Pigment dSPE with Carbon S Cleanup

Authors

Jessica Westland and
Anastasia Andrianova
Agilent Technologies, Inc.

Abstract

This application note focuses on the reliable quantitation of over 100 pesticides in kale by GC/MS/MS. The workflow was demonstrated on an Agilent 8890 GC system coupled to an Agilent 7010C triple quadrupole GC/MS using a previously developed dynamic multiple reaction monitoring (dMRM) method. The kale sample preparation strategy used the QuEChERS EN 15662 method with the Agilent Bond Elut QuEChERS High Pigment dispersive SPE kit (EN like) with Carbon S cleanup.

Introduction

Food safety testing is paramount in today's regulated environment. Much of the food we eat and enjoy today is provided through complex global systems of food production, processing, and distribution. Analytical testing at every step along the supply chain is essential to ensure food safety and quality. The Agilent multiclass, multiresidue methods based on GC/MS deliver routine monitoring, high-throughput, sensitive detection levels, and rapid quantitative analysis for hundreds of pesticides in a single sample. The 7010C triple quadrupole GC/MS maintains the benefits of the multiclass, multiresidue methods.

The QuEChERS method is the industry standard for pesticide extraction and cleanup for a wide variety of food samples. As part of the QuEChERS methodology, the dispersive solid phase extraction (dSPE) cleanup is chosen based upon the matrix that is extracted. The sorbents within the selected dSPE are specified to remove other parts of the matrix while minimizing pesticide loss. Graphitized carbon black (GCB) has widely been used in sample preparation for efficient pigment removal.^{1,2} Although GCB has been shown to be efficient in pigment removal, it also causes unwanted analyte loss, especially for compounds with planar structure. Agilent Carbon S sorbent is an advanced hybrid carbon material with optimized carbon content and pore structure. Compared to GCB, the improved sorbent provides equivalent or better pigment removal

from plant-origin sample matrices and significantly improves sensitive analyte recoveries. As a result, Carbon S sorbent delivers a better balance between analyte recovery and matrix pigment-removal efficiency than traditional GCB sorbent.^{3,4}

Experimental

Sample preparation

Organic kale was analyzed via the QuEChERS EN 15662 methodology with the High Pigment dSPE (EN like) with Carbon S (part number 5610-2074 and 5610-2076) tubes. The full procedure can be found in the Agilent application note by Westland (2022).⁵

Instrumentation

The study was performed using an Agilent 8890 GC coupled with an Agilent 7010C triple quadrupole GC/MS (Figure 1). The GC system was equipped with an Agilent 7693A automatic liquid sampler (ALS) tower and tray, a multimode inlet (MMI), an electronic pneumatic control (EPC), and an Agilent purged Ultimate union (PUU) for backflush system. Agilent MassHunter Workstation software was used for data acquisition and analysis. The GC/TQ instrument conditions are provided in Table 1.⁶ The target and ISTD compound MRM parameters are listed in Appendix 1.

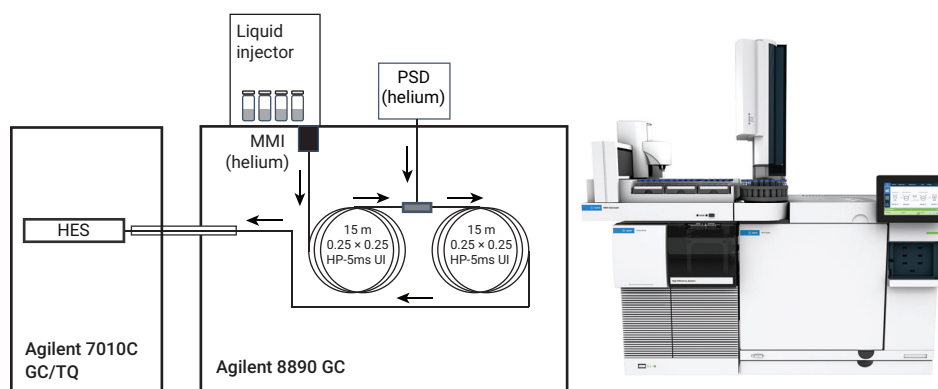

Figure 1. The Agilent 7010C triple quadrupole GC/MS (GC/TQ) coupled with an Agilent 8890 GC.

Table 1. GC/MS conditions for pesticide quantitation.

Multimode Inlet (MMI)	
Mode	Splitless
Purge Flow to Split Vent	60 mL/min at 0.75 min
Injection Volume (L1)	1.0 µL
Injection	Reversed three-layer switch (L3, L1, L2)
L1 Air Gap	0.2 µL
L2 Volume	1 µL
L2 Air Gap	0.2 µL
L3 Volume	1 µL
L3 Air Gap	0.2 µL
Inlet Temperature	280 °C
Type Carrier Gas	Helium
Inlet Liner	Agilent Ultra Inert inlet liner, splitless, dimpled, 2 mm id (p/n 5190-2297)
Oven	
Initial Oven Temperature	60 °C
Initial Oven Hold	1 min
Ramp Rate 1	40 °C/min
Final Temperature 1	170 °C
Final Hold	0 min
Ramp Rate	10 °C/min
Final Temperature 2	310 °C
Final Hold	2.25 min
Total Run Time	20 min
Postrun Time	1.5 min
Equilibration Time	0.5 min

Columns	
Column 1	Agilent J&W HP-5ms Ultra Inert, 15 m × 0.25 mm, 0.25 µm (p/n 19091S-431UI)
Control Mode	Constant flow
Flow	1.205 mL/min
Inlet Connection	MMI
Outlet Connection	PSD (PUU)
Postrun Flow (Backflushing)	-7.793 mL/min
Column 2	HP-5ms Ultra Inert, 15 m × 0.25 mm, 0.25 µm (p/n 19091S-431UI)
Control Mode	Constant flow
Flow	1.405 mL/min
Inlet Connection	PSD (PUU)
Outlet Connection	MSD
Postrun Flow (Backflushing)	8.203 mL/min
MSD	
Model	7010C
Source	HES
Tune	atunes.eihs.tune.xml
Mode	dMRM
Solvent Delay	3.75 min
EM Voltage Gain Mode	10
Quad Temperature (MS1 and MS2)	150 °C
Source Temperature	280 °C
Transfer Line Temperature	280 °C
He Quench Gas	2.25 mL/min
N ₂ Collision Gas	1.5 mL/min

Results and discussion

Following matrix-matched linearity with an $R^2 > 0.990$ over a calibration range of 0.5 to 50 parts per billion (ppb) (w/v) for all target pesticides, the pesticide recoveries were analyzed at both the pre- and postspiked values of 24 ppb. Figure 2 shows an MRM chromatogram of the 150 compounds prespiked at 24 ppb in kale.

Quantitation by matrix-matched calibration determined that 98.6% of the pesticides of the prespiked samples had recoveries between 70 and 130% at 24 ppb in kale. The quantitation accuracy and precision ($n = 6$) were

also determined to verify the results. Prespiked kale samples resulted in 99.3% of the pesticides with RSDs <25%. Figures 3 to 7 provide the graphical quantitation data for the prespiked pesticides extracted from kale.

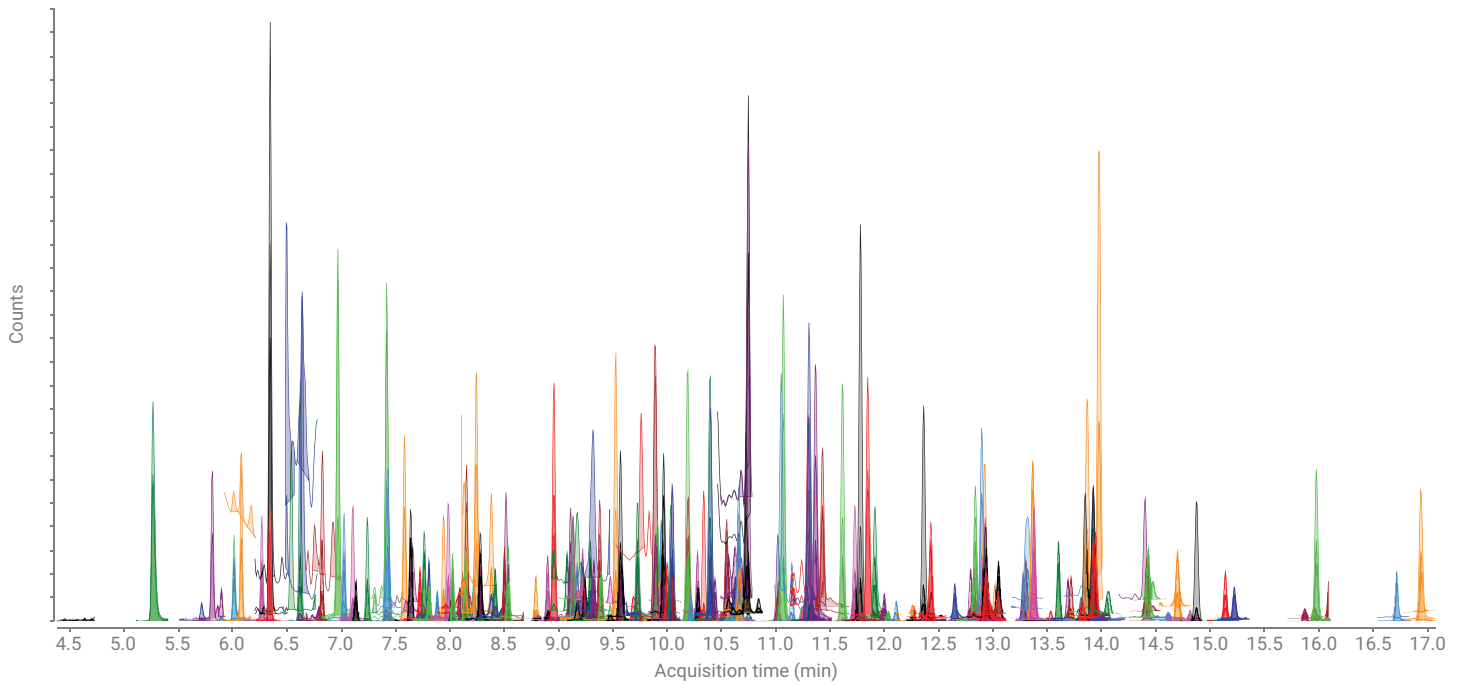

Figure 2. MRM chromatogram of 150 compounds prespiked at 24 ppb in kale.

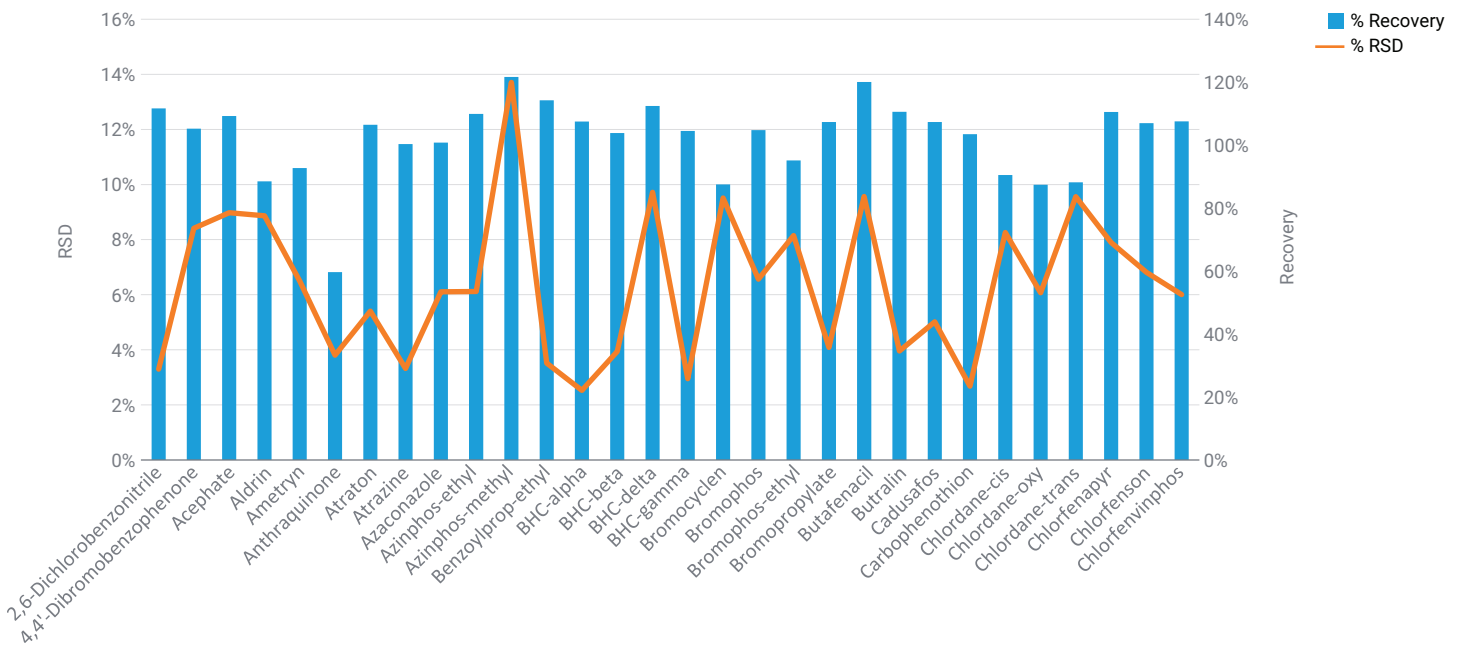

Figure 3. Recovery and RSD (%) of prespiked pesticides in kale.

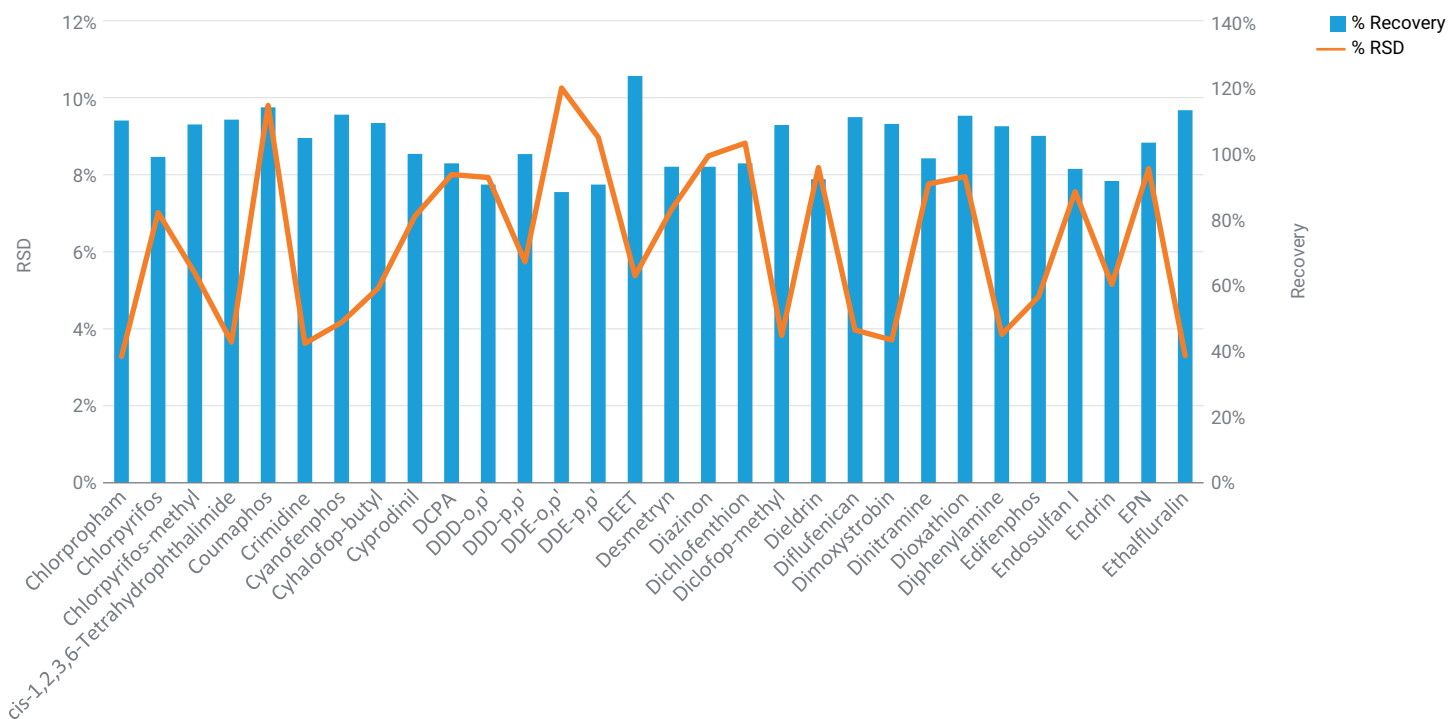

Figure 4. Recovery and RSD (%) of prespiked pesticides in kale.

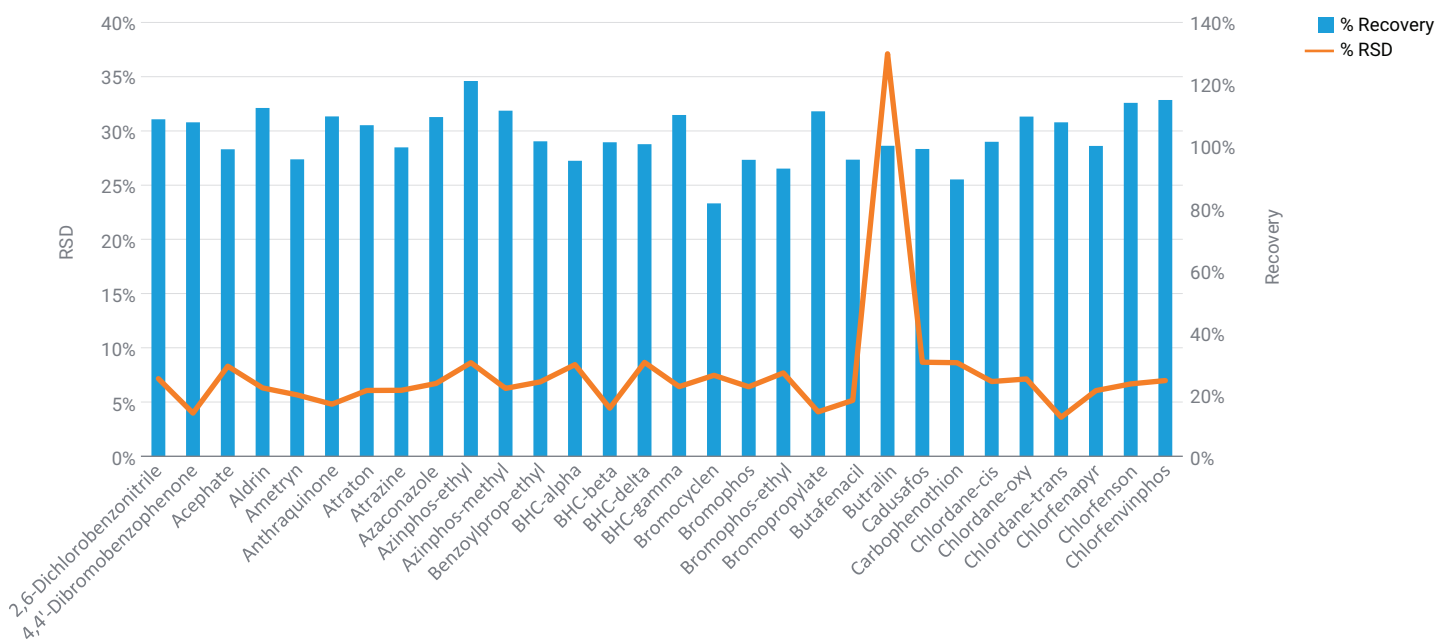

Figure 5. Recovery and RSD (%) of prespiked pesticides in kale.

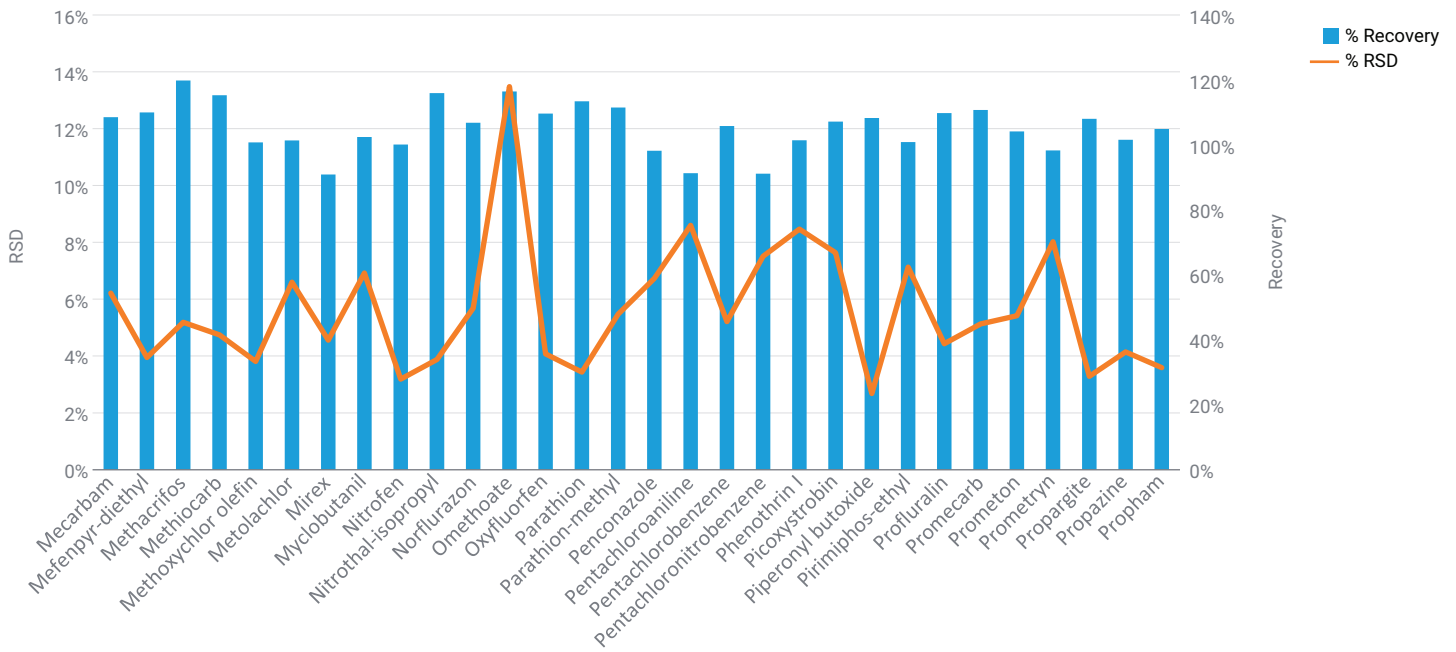

Figure 6. Recovery and RSD (%) of prespiked pesticides in kale.

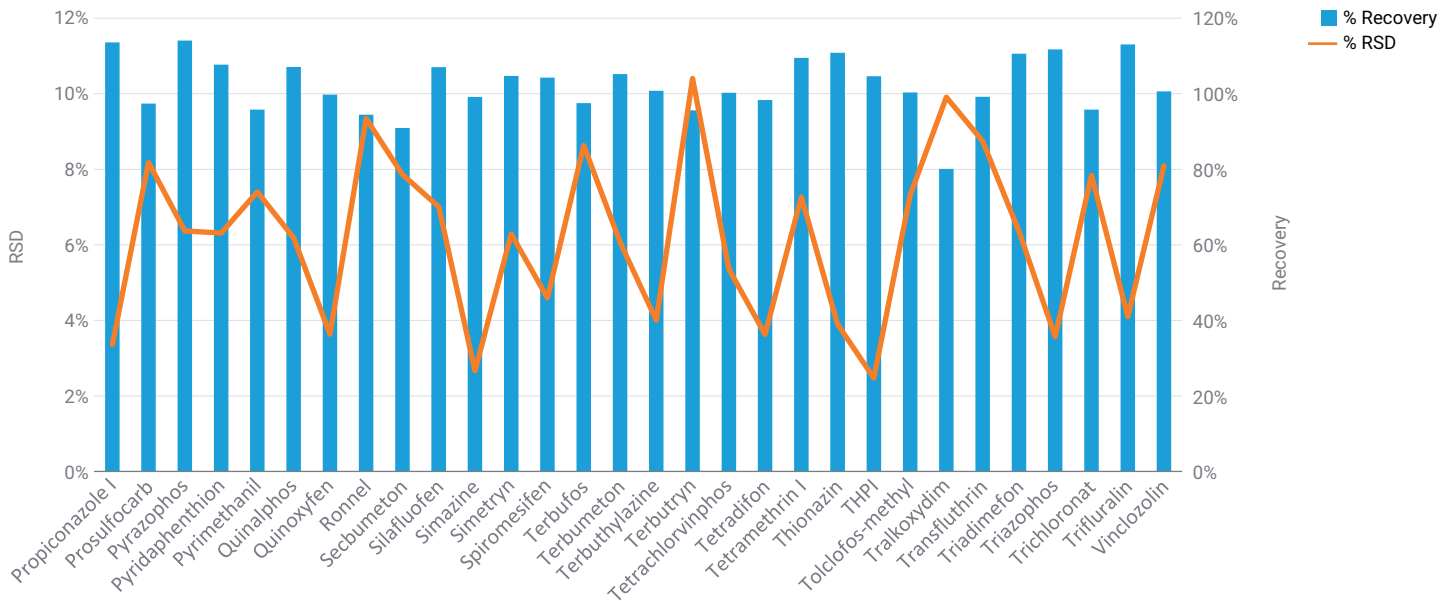

Figure 7. Recovery and RSD (%) of prespiked pesticides in kale.

Conclusion

A simple, rapid, and reliable method using extraction with the Agilent Bond Elut QuEChERS EN extraction kit, followed by cleanup with the Agilent Bond Elut QuEChERS High Pigment dispersive SPE kit (EN like) with Carbon S was shown for 150 GC/MS/MS-amenable pesticides.

References

- González-Curbelo, M. Á. *et al.* Evolution and Applications of the QuEChERS Method. *Trends in Analytical Chemistry* **2015**, *71*, 169–185.
- Varela-Martínez, D. A *et al.* Chapter 14: Quick, Easy, Cheap, Effective, Rugged, and Safe (QuEChERS) Extraction. *In* Handbooks in Separation Science: Liquid-Phase Extraction; Elsevier, 2020; pp 399–437.
- Ferlin, C.; Zhao, L. Analysis of Pesticide Residues in Spinach Using AOAC Pigmented dSPE with Carbon S Cleanup and LC/MS/MS. *Agilent Technologies application note*, publication number 5994-4769EN, **2022**.
- Yang, X.; Li, Z. Quantitative Analysis of Pesticides in Celery and Grape, *Agilent Technologies application note*, publication number 5994-4763EN, **2022**.
- Westland, J. Analysis of Pesticides in Tomato and Kale on GC/MS/MS with Agilent Bond Elut QuEChERS EN High Pigment dSPE with Carbon S, *Agilent Technologies application note*, publication number 5994-5050EN, **2022**.
- Andrianova, A.; Zhao, L. Five Keys to Unlock Maximum Performance in the Analysis of Over 200 Pesticides in Challenging Food Matrices by GC/MS/MS, *Agilent Technologies application note*, publication number 5994-4965EN, **2022**.

Appendix 1

GC/TQ MRM parameters of target and ISTD compounds

Compound Name	ISTD	RT (min)	Precursor Ion	MS1 Resolution	Product Ion	MS2 Resolution	Dwell	CE (eV)
2,6-Dichlorobenzonitrile	FALSE	5.26	173.0	Wide	100.0	Wide	132.5	25
2,6-Dichlorobenzonitrile	FALSE	5.26	171.0	Wide	136.1	Wide	132.5	15
2,6-Dichlorobenzonitrile	FALSE	5.26	171.0	Wide	100.0	Wide	132.5	25
4,4'-Dibromobenzophenone	FALSE	11.91	182.9	Wide	154.9	Wide	18.6	15
4,4'-Dibromobenzophenone	FALSE	11.91	182.9	Wide	76.0	Wide	18.6	35
4,4'-Dibromobenzophenone	FALSE	11.91	156.9	Wide	76.0	Wide	18.6	15
Acephate	FALSE	5.66	136.0	Wide	94.0	Wide	80.6	15
Acephate	FALSE	5.66	94.0	Wide	64.0	Wide	80.6	10
Acephate	FALSE	5.66	78.9	Wide	47.0	Wide	80.6	10
Aldrin	FALSE	9.94	262.9	Wide	192.9	Wide	12.5	35
Aldrin	FALSE	9.94	262.9	Wide	190.9	Wide	12.5	35
Aldrin	FALSE	9.94	254.9	Wide	220.0	Wide	12.5	20
Allethrin	FALSE	10.63	123.0	Wide	81.0	Wide	7.7	10
Allethrin	FALSE	10.63	107.0	Wide	91.0	Wide	7.7	10
Allethrin	FALSE	10.63	91.0	Wide	65.0	Wide	7.7	15
alpha-BHC-d ₆	TRUE	7.58	224.0	Wide	187.0	Wide	20.7	15
alpha-BHC-d ₆	TRUE	7.58	224.0	Wide	150.0	Wide	20.7	15
Ametryn	FALSE	9.23	227.0	Wide	170.1	Wide	10.8	10
Ametryn	FALSE	9.23	227.0	Wide	58.1	Wide	10.8	10
Ametryn	FALSE	9.23	185.0	Wide	170.0	Wide	10.8	5

Compound Name	ISTD	RT (min)	Precursor Ion	MS1 Resolution	Product Ion	MS2 Resolution	Dwell	CE (eV)
Anilazine	FALSE	10.57	241.0	Wide	143.1	Wide	9.4	25
Anilazine	FALSE	10.57	239.1	Wide	178.1	Wide	9.4	15
Anilazine	FALSE	10.57	239.1	Wide	143.1	Wide	9.4	25
Anthraquinone	FALSE	9.92	208.0	Wide	180.2	Wide	14.2	10
Anthraquinone	FALSE	9.92	208.0	Wide	152.2	Wide	14.2	20
Anthraquinone	FALSE	9.92	180.0	Wide	152.1	Wide	14.2	10
Atraton	FALSE	7.70	211.0	Wide	169.1	Wide	18.0	5
Atraton	FALSE	7.70	211.0	Wide	58.1	Wide	18.0	10
Atraton	FALSE	7.70	169.0	Wide	154.1	Wide	18.0	5
Atrazine	FALSE	7.89	214.9	Wide	200.2	Wide	15.4	5
Atrazine	FALSE	7.89	214.9	Wide	58.1	Wide	15.4	10
Atrazine	FALSE	7.89	200.0	Wide	122.1	Wide	15.4	5
Azaconazole	FALSE	11.84	219.0	Wide	175.0	Wide	18.6	15
Azaconazole	FALSE	11.84	217.0	Wide	173.1	Wide	18.6	15
Azaconazole	FALSE	11.84	173.0	Wide	145.0	Wide	18.6	15
Azinphos-ethyl	FALSE	15.21	160.0	Wide	132.1	Wide	80.6	0
Azinphos-ethyl	FALSE	15.21	160.0	Wide	77.1	Wide	80.6	20
Azinphos-ethyl	FALSE	15.21	132.0	Wide	77.1	Wide	80.6	15
Azinphos-methyl	FALSE	14.60	160.0	Wide	132.1	Wide	39.1	5
Azinphos-methyl	FALSE	14.60	160.0	Wide	77.0	Wide	39.1	20
Azinphos-methyl	FALSE	14.60	132.1	Wide	77.0	Wide	39.1	15
Benfuracarb	FALSE	15.19	164.2	Wide	149.1	Wide	58.4	10
Benfuracarb	FALSE	15.19	164.2	Wide	103.1	Wide	58.4	30
Benfuracarb	FALSE	15.19	163.0	Wide	107.0	Wide	58.4	15
Benzoylprop-ethyl	FALSE	13.67	292.0	Wide	105.0	Wide	19.4	5
Benzoylprop-ethyl	FALSE	13.67	105.0	Wide	77.1	Wide	19.4	15
Benzoylprop-ethyl	FALSE	13.67	105.0	Wide	51.1	Wide	19.4	35
BHC-alpha	FALSE	7.64	218.9	Wide	183.0	Wide	19.7	5
BHC-alpha	FALSE	7.64	216.9	Wide	181.0	Wide	19.7	5
BHC-alpha	FALSE	7.64	180.9	Wide	145.0	Wide	19.7	15
BHC-beta	FALSE	8.03	218.9	Wide	183.1	Wide	14.2	5
BHC-beta	FALSE	8.03	216.9	Wide	181.1	Wide	14.2	5
BHC-beta	FALSE	8.03	181.0	Wide	145.0	Wide	14.2	15
BHC-delta	FALSE	8.51	219.0	Wide	183.1	Wide	21.0	5
BHC-delta	FALSE	8.51	217.0	Wide	181.1	Wide	21.0	5
BHC-delta	FALSE	8.51	181.1	Wide	145.1	Wide	21.0	15
BHC-gamma	FALSE	8.15	218.9	Wide	183.1	Wide	12.6	5
BHC-gamma	FALSE	8.15	216.9	Wide	181.0	Wide	12.6	5
BHC-gamma	FALSE	8.15	181.0	Wide	145.0	Wide	12.6	15
Binapacryl	FALSE	11.99	100.0	Wide	84.9	Wide	20.9	5
Binapacryl	FALSE	11.99	100.0	Wide	82.0	Wide	20.9	5
Binapacryl	FALSE	11.99	83.0	Wide	55.1	Wide	20.9	5
Bromocyclen	FALSE	8.80	356.8	Wide	277.7	Wide	39.5	5
Bromocyclen	FALSE	8.80	271.8	Wide	236.9	Wide	39.5	15
Bromocyclen	FALSE	8.80	236.9	Wide	118.9	Wide	39.5	30
Bromophos	FALSE	10.28	330.9	Wide	315.9	Wide	14.5	20
Bromophos	FALSE	10.28	125.0	Wide	79.0	Wide	14.5	5

Compound Name	ISTD	RT (min)	Precursor Ion	MS1 Resolution	Product Ion	MS2 Resolution	Dwell	CE (eV)
Bromophos	FALSE	10.28	125.0	Wide	47.0	Wide	14.5	15
Bromophos-ethyl	FALSE	11.02	358.7	Wide	302.8	Wide	23.4	15
Bromophos-ethyl	FALSE	11.02	302.8	Wide	284.7	Wide	23.4	15
Bromophos-ethyl	FALSE	11.02	241.9	Wide	96.9	Wide	23.4	30
Bromopropylate	FALSE	13.91	338.8	Wide	182.9	Wide	20.1	20
Bromopropylate	FALSE	13.91	185.0	Wide	157.0	Wide	20.1	15
Bromopropylate	FALSE	13.91	183.0	Wide	155.0	Wide	20.1	15
Bromoxynil	FALSE	7.41	276.8	Wide	88.0	Wide	21.4	30
Bromoxynil	FALSE	7.41	274.7	Wide	167.9	Wide	21.4	15
Bromoxynil	FALSE	7.41	274.7	Wide	88.0	Wide	21.4	30
Butafenacil	FALSE	15.96	331.0	Wide	180.0	Wide	80.5	25
Butafenacil	FALSE	15.96	331.0	Wide	123.9	Wide	80.5	45
Butafenacil	FALSE	15.96	180.0	Wide	124.0	Wide	80.5	15
Butralin	FALSE	10.22	266.0	Wide	220.2	Wide	13.6	10
Butralin	FALSE	10.22	266.0	Wide	174.2	Wide	13.6	20
Butralin	FALSE	10.22	224.1	Wide	132.1	Wide	13.6	15
Cadusafos	FALSE	7.43	158.8	Wide	131.0	Wide	22.6	5
Cadusafos	FALSE	7.43	158.8	Wide	97.0	Wide	22.6	15
Cadusafos	FALSE	7.43	157.9	Wide	96.9	Wide	22.6	15
Captafol	FALSE	13.43	183.0	Wide	79.0	Wide	22.0	10
Captafol	FALSE	13.43	150.0	Wide	79.0	Wide	22.0	5
Captafol	FALSE	13.43	150.0	Wide	71.9	Wide	22.0	5
Carbophenothion	FALSE	12.82	342.0	Wide	157.0	Wide	19.1	10
Carbophenothion	FALSE	12.82	199.0	Wide	143.0	Wide	19.1	10
Carbophenothion	FALSE	12.82	153.0	Wide	96.9	Wide	19.1	10
Chlordane-cis	FALSE	11.29	372.8	Wide	300.9	Wide	15.7	10
Chlordane-cis	FALSE	11.29	372.8	Wide	265.9	Wide	15.7	25
Chlordane-cis	FALSE	11.29	271.8	Wide	236.9	Wide	15.7	15
Chlordane-oxy	FALSE	10.64	184.9	Wide	121.0	Wide	7.7	15
Chlordane-oxy	FALSE	10.64	114.9	Wide	87.0	Wide	7.7	15
Chlordane-oxy	FALSE	10.64	114.9	Wide	51.1	Wide	7.7	25
Chlordane-trans	FALSE	11.03	374.8	Wide	265.8	Wide	23.0	15
Chlordane-trans	FALSE	11.03	372.8	Wide	265.8	Wide	23.0	15
Chlordane-trans	FALSE	11.03	271.7	Wide	236.9	Wide	23.0	15
Chlorfenapyr	FALSE	12.04	328.0	Wide	247.0	Wide	23.1	20
Chlorfenapyr	FALSE	12.04	247.1	Wide	227.1	Wide	23.1	20
Chlorfenapyr	FALSE	12.04	137.0	Wide	102.0	Wide	23.1	15
Chlorfenson	FALSE	11.37	177.0	Wide	113.0	Wide	23.7	10
Chlorfenson	FALSE	11.37	175.0	Wide	111.0	Wide	23.7	10
Chlorfenson	FALSE	11.37	111.0	Wide	75.0	Wide	23.7	15
Chlorfenvinphos	FALSE	10.66	294.9	Wide	266.9	Wide	8.1	5
Chlorfenvinphos	FALSE	10.66	266.9	Wide	159.0	Wide	8.1	20
Chlorfenvinphos	FALSE	10.66	266.9	Wide	81.0	Wide	8.1	30
Chlorpropham	FALSE	7.11	153.0	Wide	125.1	Wide	22.5	10
Chlorpropham	FALSE	7.11	153.0	Wide	90.0	Wide	22.5	25
Chlorpropham	FALSE	7.11	127.0	Wide	65.1	Wide	22.5	25
Chlorpyrifos	FALSE	9.95	313.8	Wide	257.8	Wide	12.5	15

Compound Name	ISTD	RT (min)	Precursor Ion	MS1 Resolution	Product Ion	MS2 Resolution	Dwell	CE (eV)
Chlorpyrifos	FALSE	9.95	198.9	Wide	171.0	Wide	12.5	15
Chlorpyrifos	FALSE	9.95	196.9	Wide	169.0	Wide	12.5	15
Chlorpyrifos-methyl	FALSE	9.14	285.9	Wide	93.0	Wide	11.8	25
Chlorpyrifos-methyl	FALSE	9.14	124.9	Wide	47.0	Wide	11.8	15
Chlorpyrifos-methyl	FALSE	9.14	78.9	Wide	47.0	Wide	11.8	10
<i>cis</i> -1,2,3,6-Tetrahydrophthalimide	FALSE	5.98	151.1	Wide	80.0	Wide	37.8	5
<i>cis</i> -1,2,3,6-Tetrahydrophthalimide	FALSE	5.98	79.0	Wide	77.0	Wide	37.8	15
<i>cis</i> -1,2,3,6-Tetrahydrophthalimide	FALSE	5.98	79.0	Wide	51.0	Wide	37.8	30
Coumaphos	FALSE	15.85	361.9	Wide	109.0	Wide	80.5	15
Coumaphos	FALSE	15.85	225.9	Wide	163.1	Wide	80.5	15
Coumaphos	FALSE	15.85	210.0	Wide	182.0	Wide	80.5	10
Crimidine	FALSE	6.25	172.9	Wide	144.1	Wide	47.5	5
Crimidine	FALSE	6.25	170.9	Wide	142.1	Wide	47.5	5
Crimidine	FALSE	6.25	142.0	Wide	106.1	Wide	47.5	10
Cyanofenphos	FALSE	12.89	185.0	Wide	157.0	Wide	16.3	5
Cyanofenphos	FALSE	12.89	169.0	Wide	141.1	Wide	16.3	5
Cyanofenphos	FALSE	12.89	169.0	Wide	77.1	Wide	16.3	25
Cyhalofop-butyl	FALSE	14.68	256.2	Wide	120.1	Wide	39.1	10
Cyhalofop-butyl	FALSE	14.68	229.2	Wide	109.1	Wide	39.1	15
Cyhalofop-butyl	FALSE	14.68	120.1	Wide	91.0	Wide	39.1	15
Cyprodinil	FALSE	10.39	226.2	Wide	225.3	Wide	13.3	10
Cyprodinil	FALSE	10.39	225.2	Wide	224.3	Wide	13.3	10
Cyprodinil	FALSE	10.39	224.2	Wide	208.2	Wide	13.3	20
DCPA	FALSE	10.06	331.8	Wide	300.9	Wide	12.4	10
DCPA	FALSE	10.06	300.9	Wide	223.0	Wide	12.4	25
DCPA	FALSE	10.06	298.9	Wide	221.0	Wide	12.4	25
DDD-o,p'	FALSE	11.78	235.0	Wide	200.1	Wide	19.5	10
DDD-o,p'	FALSE	11.78	235.0	Wide	165.1	Wide	19.5	25
DDD-o,p'	FALSE	11.78	199.1	Wide	164.1	Wide	19.5	20
DDD-p,p'	FALSE	12.36	237.0	Wide	200.1	Wide	31.1	15
DDD-p,p'	FALSE	12.36	237.0	Wide	165.1	Wide	31.1	25
DDD-p,p'	FALSE	12.36	165.1	Wide	115.0	Wide	31.1	35
DDE-o,p'	FALSE	11.08	317.8	Wide	248.0	Wide	19.3	15
DDE-o,p'	FALSE	11.08	248.0	Wide	176.2	Wide	19.3	30
DDE-o,p'	FALSE	11.08	246.0	Wide	176.2	Wide	19.3	30
DDE-p,p'	FALSE	11.61	317.8	Wide	246.0	Wide	33.9	15
DDE-p,p'	FALSE	11.61	315.8	Wide	246.0	Wide	33.9	15
DDE-p,p'	FALSE	11.61	246.1	Wide	176.2	Wide	33.9	30
DEET	FALSE	6.63	119.1	Wide	91.0	Wide	43.6	10
DEET	FALSE	6.63	119.1	Wide	65.1	Wide	43.6	20
DEET	FALSE	6.63	91.0	Wide	65.1	Wide	43.6	10
Desmedipham	FALSE	7.59	135.0	Wide	79.0	Wide	20.7	15
Desmedipham	FALSE	7.59	135.0	Wide	52.0	Wide	20.7	25
Desmedipham	FALSE	7.59	109.0	Wide	80.0	Wide	20.7	15
Desmetryn	FALSE	8.89	213.0	Wide	171.2	Wide	30.4	5
Desmetryn	FALSE	8.89	213.0	Wide	58.1	Wide	30.4	10
Desmetryn	FALSE	8.89	171.0	Wide	156.0	Wide	30.4	5

Compound Name	ISTD	RT (min)	Precursor Ion	MS1 Resolution	Product Ion	MS2 Resolution	Dwell	CE (eV)
Diazinon	FALSE	8.29	199.1	Wide	93.0	Wide	13.0	15
Diazinon	FALSE	8.29	137.1	Wide	84.0	Wide	13.0	10
Diazinon	FALSE	8.29	137.1	Wide	54.0	Wide	13.0	20
Dichlofenthion	FALSE	8.97	279.0	Wide	223.0	Wide	19.4	15
Dichlofenthion	FALSE	8.97	279.0	Wide	204.9	Wide	19.4	30
Dichlofenthion	FALSE	8.97	223.0	Wide	204.9	Wide	19.4	15
Dichlofluanid	FALSE	9.76	167.1	Wide	124.0	Wide	19.6	10
Dichlofluanid	FALSE	9.76	123.0	Wide	77.0	Wide	19.6	20
Dichlofluanid	FALSE	9.76	123.0	Wide	51.0	Wide	19.6	40
Diclofop-methyl	FALSE	13.26	339.9	Wide	252.9	Wide	25.5	10
Diclofop-methyl	FALSE	13.26	280.8	Wide	119.9	Wide	25.5	10
Diclofop-methyl	FALSE	13.26	253.0	Wide	162.1	Wide	25.5	15
Dicofol, p, p ¹ -	FALSE	14.07	183.9	Wide	169.3	Wide	39.3	5
Dicofol, p, p ¹ -	FALSE	14.07	183.9	Wide	155.0	Wide	39.3	30
Dicofol, p, p ¹ -	FALSE	14.07	183.9	Wide	141.2	Wide	39.3	20
Dieldrin	FALSE	11.72	277.0	Wide	241.0	Wide	20.5	5
Dieldrin	FALSE	11.72	262.9	Wide	193.0	Wide	20.5	35
Dieldrin	FALSE	11.72	262.9	Wide	191.0	Wide	20.5	35
Diiflufenican	FALSE	13.29	393.9	Wide	265.9	Wide	21.2	10
Diiflufenican	FALSE	13.29	266.0	Wide	246.1	Wide	21.2	15
Diiflufenican	FALSE	13.29	266.0	Wide	238.1	Wide	21.2	15
Dimoxystrobin	FALSE	13.85	205.0	Wide	116.0	Wide	17.4	10
Dimoxystrobin	FALSE	13.85	116.0	Wide	89.0	Wide	17.4	15
Dimoxystrobin	FALSE	13.85	116.0	Wide	63.0	Wide	17.4	30
Dinitramine	FALSE	8.40	260.7	Wide	241.0	Wide	15.0	10
Dinitramine	FALSE	8.40	260.7	Wide	195.0	Wide	15.0	20
Dinitramine	FALSE	8.40	216.0	Wide	196.0	Wide	15.0	10
Dinobuton	FALSE	10.72	211.0	Wide	163.0	Wide	9.9	5
Dinobuton	FALSE	10.72	211.0	Wide	117.0	Wide	9.9	15
Dinobuton	FALSE	10.72	211.0	Wide	89.0	Wide	9.9	30
Dinocap I	FALSE	13.31	265.9	Wide	167.2	Wide	18.8	18
Dinocap I	FALSE	13.31	69.0	Wide	41.1	Wide	18.8	10
Dinocap I	FALSE	13.31	69.0	Wide	39.1	Wide	18.8	25
Dioxathion	FALSE	15.94	271.0	Wide	96.9	Wide	58.3	30
Dioxathion	FALSE	15.94	152.9	Wide	96.9	Wide	58.3	10
Dioxathion	FALSE	15.94	124.9	Wide	96.9	Wide	58.3	5
Diphenylamine	FALSE	6.97	169.0	Wide	168.2	Wide	28.2	15
Diphenylamine	FALSE	6.97	168.0	Wide	167.2	Wide	28.2	15
Diphenylamine	FALSE	6.97	167.0	Wide	166.2	Wide	28.2	20
DMST	FALSE	8.03	106.0	Wide	79.0	Wide	14.2	5
DMST	FALSE	8.03	106.0	Wide	77.0	Wide	14.2	15
DMST	FALSE	8.03	78.9	Wide	77.0	Wide	14.2	10
Edifenphos	FALSE	12.92	201.0	Wide	109.0	Wide	15.6	10
Edifenphos	FALSE	12.92	172.9	Wide	109.0	Wide	15.6	5
Edifenphos	FALSE	12.92	108.9	Wide	65.1	Wide	15.6	15
Endosulfan I (alpha isomer)	FALSE	11.26	194.9	Wide	160.0	Wide	16.8	5
Endosulfan I (alpha isomer)	FALSE	11.26	194.9	Wide	159.0	Wide	16.8	5

Compound Name	ISTD	RT (min)	Precursor Ion	MS1 Resolution	Product Ion	MS2 Resolution	Dwell	CE (eV)
Endosulfan I (alpha isomer)	FALSE	11.26	194.9	Wide	125.0	Wide	16.8	20
Endosulfan II (beta isomer)	FALSE	12.27	206.9	Wide	172.0	Wide	30.6	15
Endosulfan II (beta isomer)	FALSE	12.27	194.9	Wide	158.9	Wide	30.6	10
Endosulfan II (beta isomer)	FALSE	12.27	194.9	Wide	124.9	Wide	30.6	25
Endrin	FALSE	12.12	316.7	Wide	280.8	Wide	27.6	5
Endrin	FALSE	12.12	262.8	Wide	193.0	Wide	27.6	35
Endrin	FALSE	12.12	244.8	Wide	173.0	Wide	27.6	30
EPN	FALSE	13.94	185.0	Wide	157.1	Wide	23.1	5
EPN	FALSE	13.94	169.0	Wide	141.1	Wide	23.1	5
EPN	FALSE	13.94	169.0	Wide	77.1	Wide	23.1	25
Esbiothrin	FALSE	10.60	123.1	Wide	41.0	Wide	8.0	30
Esbiothrin	FALSE	10.60	91.0	Wide	65.0	Wide	8.0	15
Esbiothrin	FALSE	10.60	91.0	Wide	39.1	Wide	8.0	35
Ethalfuralin	FALSE	7.14	315.9	Wide	275.9	Wide	20.7	10
Ethalfuralin	FALSE	7.14	275.9	Wide	248.1	Wide	20.7	10
Ethalfuralin	FALSE	7.14	275.9	Wide	202.1	Wide	20.7	15
Ethion	FALSE	12.42	230.9	Wide	175.0	Wide	30.8	10
Ethion	FALSE	12.42	152.9	Wide	96.9	Wide	30.8	10
Ethion	FALSE	12.42	124.9	Wide	96.9	Wide	30.8	0
Ethoprophos	FALSE	7.02	157.9	Wide	114.0	Wide	25.6	5
Ethoprophos	FALSE	7.02	157.9	Wide	97.0	Wide	25.6	15
Ethoprophos	FALSE	7.02	138.9	Wide	97.0	Wide	25.6	5
Etrimfos	FALSE	8.54	292.1	Wide	181.1	Wide	25.9	5
Etrimfos	FALSE	8.54	181.1	Wide	153.1	Wide	25.9	10
Etrimfos	FALSE	8.54	181.1	Wide	56.1	Wide	25.9	25
Famphur	FALSE	12.79	218.0	Wide	109.0	Wide	27.7	15
Famphur	FALSE	12.79	218.0	Wide	79.0	Wide	27.7	30
Famphur	FALSE	12.79	124.9	Wide	47.0	Wide	27.7	15
Fenamiphos	FALSE	11.31	302.9	Wide	287.9	Wide	18.1	10
Fenamiphos	FALSE	11.31	217.0	Wide	202.1	Wide	18.1	10
Fenamiphos	FALSE	11.31	154.0	Wide	139.0	Wide	18.1	10
Fenitrothion	FALSE	9.59	277.0	Wide	260.1	Wide	22.8	5
Fenitrothion	FALSE	9.59	125.1	Wide	79.0	Wide	22.8	5
Fenitrothion	FALSE	9.59	125.1	Wide	47.0	Wide	22.8	15
Fenpropathrin	FALSE	14.04	207.9	Wide	181.0	Wide	33.3	5
Fenpropathrin	FALSE	14.04	181.1	Wide	152.1	Wide	33.3	25
Fenpropathrin	FALSE	14.04	125.0	Wide	55.1	Wide	33.3	10
Fenson	FALSE	10.19	267.9	Wide	141.1	Wide	13.1	5
Fenson	FALSE	10.19	267.9	Wide	77.1	Wide	13.1	20
Fenson	FALSE	10.19	141.0	Wide	77.1	Wide	13.1	5
Fensulfothion	FALSE	12.25	291.8	Wide	156.0	Wide	30.2	15
Fensulfothion	FALSE	12.25	156.0	Wide	141.0	Wide	30.2	10
Fensulfothion	FALSE	12.25	140.0	Wide	125.0	Wide	30.2	10
Fipronil	FALSE	10.64	366.8	Wide	212.8	Wide	8.1	25
Fipronil	FALSE	10.64	350.8	Wide	254.8	Wide	8.1	15
Fipronil	FALSE	10.64	254.9	Wide	228.0	Wide	8.1	15
Flubenzimine	FALSE	11.52	186.0	Wide	69.0	Wide	31.8	25

Compound Name	ISTD	RT (min)	Precursor Ion	MS1 Resolution	Product Ion	MS2 Resolution	Dwell	CE (eV)
Flubenzimine	FALSE	11.52	135.0	Wide	77.1	Wide	31.8	20
Flubenzimine	FALSE	11.52	135.0	Wide	51.1	Wide	31.8	40
Flucythrinate I	FALSE	16.69	198.9	Wide	157.0	Wide	99.1	10
Flucythrinate I	FALSE	16.69	198.9	Wide	107.0	Wide	99.1	25
Flucythrinate I	FALSE	16.69	156.9	Wide	107.1	Wide	99.1	15
Flufenacet	FALSE	9.96	151.0	Wide	136.1	Wide	12.0	10
Flufenacet	FALSE	9.96	151.0	Wide	95.0	Wide	12.0	30
Flufenacet	FALSE	9.96	123.0	Wide	95.0	Wide	12.0	20
Flutriafol	FALSE	11.30	219.1	Wide	123.1	Wide	18.1	15
Flutriafol	FALSE	11.30	123.1	Wide	95.0	Wide	18.1	15
Flutriafol	FALSE	11.30	123.1	Wide	75.1	Wide	18.1	25
Fonofos	FALSE	8.25	246.1	Wide	137.0	Wide	12.9	5
Fonofos	FALSE	8.25	137.0	Wide	109.0	Wide	12.9	5
Fonofos	FALSE	8.25	109.0	Wide	80.9	Wide	12.9	5
Fosthiazate I	FALSE	10.27	199.0	Wide	102.0	Wide	14.5	5
Fosthiazate I	FALSE	10.27	195.0	Wide	103.0	Wide	14.5	5
Fosthiazate I	FALSE	10.27	195.0	Wide	60.0	Wide	14.5	20
Fuberidazole	FALSE	9.16	184.0	Wide	156.2	Wide	11.3	10
Fuberidazole	FALSE	9.16	184.0	Wide	155.1	Wide	11.3	30
Fuberidazole	FALSE	9.16	183.0	Wide	155.1	Wide	11.3	10
Furathiocarb	FALSE	14.41	163.1	Wide	135.1	Wide	40.8	5
Furathiocarb	FALSE	14.41	163.1	Wide	107.1	Wide	40.8	15
Furathiocarb	FALSE	14.41	135.1	Wide	107.1	Wide	40.8	5
Heptachlor	FALSE	9.34	273.7	Wide	238.9	Wide	13.0	15
Heptachlor	FALSE	9.34	273.7	Wide	236.9	Wide	13.0	15
Heptachlor	FALSE	9.34	271.7	Wide	236.9	Wide	13.0	15
Heptachlor endo-epoxide	FALSE	10.67	216.9	Wide	182.0	Wide	9.4	20
Heptachlor endo-epoxide	FALSE	10.67	183.0	Wide	119.0	Wide	9.4	30
Heptachlor endo-epoxide	FALSE	10.67	135.0	Wide	99.0	Wide	9.4	15
Heptachlor exo-epoxide	FALSE	10.61	354.8	Wide	264.9	Wide	8.0	15
Heptachlor exo-epoxide	FALSE	10.61	352.8	Wide	262.9	Wide	8.0	15
Heptachlor exo-epoxide	FALSE	10.61	262.9	Wide	193.0	Wide	8.0	35
Heptenophos	FALSE	6.61	124.0	Wide	89.0	Wide	43.6	10
Heptenophos	FALSE	6.61	124.0	Wide	63.0	Wide	43.6	35
Heptenophos	FALSE	6.61	108.9	Wide	78.9	Wide	43.6	5
Hexachlorobenzene	FALSE	7.78	283.8	Wide	248.8	Wide	15.4	15
Hexachlorobenzene	FALSE	7.78	283.8	Wide	213.9	Wide	15.4	30
Hexachlorobenzene	FALSE	7.78	281.8	Wide	211.9	Wide	15.4	30
loxynil	FALSE	9.68	370.8	Wide	117.0	Wide	22.9	25
loxynil	FALSE	9.68	117.1	Wide	89.0	Wide	22.9	10
loxynil	FALSE	9.68	117.1	Wide	62.0	Wide	22.9	15
Iprodione	FALSE	13.69	313.8	Wide	55.9	Wide	19.1	20
Iprodione	FALSE	13.69	243.9	Wide	187.0	Wide	19.1	5
Iprodione	FALSE	13.69	187.0	Wide	124.0	Wide	19.1	25
Isazofos	FALSE	8.52	256.9	Wide	162.0	Wide	21.0	5
Isazofos	FALSE	8.52	161.0	Wide	146.0	Wide	21.0	5
Isazofos	FALSE	8.52	161.0	Wide	119.1	Wide	21.0	5

Compound Name	ISTD	RT (min)	Precursor Ion	MS1 Resolution	Product Ion	MS2 Resolution	Dwell	CE (eV)
Isodrin	FALSE	10.45	195.0	Wide	123.0	Wide	12.1	30
Isodrin	FALSE	10.45	193.0	Wide	157.0	Wide	12.1	20
Isodrin	FALSE	10.45	193.0	Wide	123.0	Wide	12.1	30
Isofenphos	FALSE	10.66	212.9	Wide	185.1	Wide	8.1	5
Isofenphos	FALSE	10.66	212.9	Wide	121.1	Wide	8.1	10
Isofenphos	FALSE	10.66	185.0	Wide	121.1	Wide	8.1	5
Isofenphos-methyl	FALSE	10.39	199.0	Wide	121.0	Wide	13.3	15
Isofenphos-methyl	FALSE	10.39	121.0	Wide	65.0	Wide	13.3	20
Isofenphos-methyl	FALSE	10.39	121.0	Wide	39.1	Wide	13.3	40
Isoprocab I	FALSE	6.34	136.0	Wide	121.1	Wide	45.8	10
Isoprocab I	FALSE	6.34	121.0	Wide	103.1	Wide	45.8	10
Isoprocab I	FALSE	6.34	121.0	Wide	77.1	Wide	45.8	20
Isopropalin	FALSE	10.34	280.1	Wide	238.1	Wide	14.1	10
Isopropalin	FALSE	10.34	280.1	Wide	180.1	Wide	14.1	15
Isopropalin	FALSE	10.34	280.1	Wide	165.1	Wide	14.1	20
Malaoxon	FALSE	9.07	126.9	Wide	99.0	Wide	15.7	5
Malaoxon	FALSE	9.07	126.9	Wide	55.0	Wide	15.7	5
Malaoxon	FALSE	9.07	98.9	Wide	71.0	Wide	15.7	5
Malathion	FALSE	9.73	172.9	Wide	99.0	Wide	22.0	15
Malathion	FALSE	9.73	157.8	Wide	125.0	Wide	22.0	5
Malathion	FALSE	9.73	126.9	Wide	99.0	Wide	22.0	5
Mecarbam	FALSE	10.66	158.9	Wide	131.0	Wide	8.1	5
Mecarbam	FALSE	10.66	130.9	Wide	86.0	Wide	8.1	10
Mecarbam	FALSE	10.66	130.9	Wide	74.0	Wide	8.1	5
Mefenpyr-diethyl	FALSE	13.59	299.0	Wide	252.9	Wide	22.3	10
Mefenpyr-diethyl	FALSE	13.59	253.0	Wide	190.0	Wide	22.3	20
Mefenpyr-diethyl	FALSE	13.59	253.0	Wide	189.0	Wide	22.3	30
Methacrifos	FALSE	6.06	207.9	Wide	180.1	Wide	43.8	5
Methacrifos	FALSE	6.06	124.9	Wide	79.0	Wide	43.8	5
Methacrifos	FALSE	6.06	124.9	Wide	47.1	Wide	43.8	10
Methamidophos	FALSE	4.58	141.0	Wide	95.0	Wide	99.2	5
Methamidophos	FALSE	4.58	141.0	Wide	80.0	Wide	99.2	20
Methamidophos	FALSE	4.58	141.0	Wide	64.0	Wide	99.2	25
Methiocarb	FALSE	9.58	168.0	Wide	153.1	Wide	21.4	10
Methiocarb	FALSE	9.58	168.0	Wide	109.1	Wide	21.4	15
Methiocarb	FALSE	9.58	153.0	Wide	109.1	Wide	21.4	5
Methoxychlor olefin	FALSE	12.83	308.0	Wide	238.0	Wide	18.6	20
Methoxychlor olefin	FALSE	12.83	238.0	Wide	223.1	Wide	18.6	15
Methoxychlor olefin	FALSE	12.83	238.0	Wide	195.1	Wide	18.6	20
Metolachlor	FALSE	9.89	240.0	Wide	162.2	Wide	16.6	10
Metolachlor	FALSE	9.89	238.0	Wide	162.2	Wide	16.6	10
Metolachlor	FALSE	9.89	162.2	Wide	133.2	Wide	16.6	15
Mirex	FALSE	14.87	271.8	Wide	236.8	Wide	68.0	20
Mirex	FALSE	14.87	236.9	Wide	142.9	Wide	68.0	30
Mirex	FALSE	14.87	236.9	Wide	118.9	Wide	68.0	30
Myclobutanil	FALSE	11.72	179.0	Wide	125.1	Wide	20.5	10
Myclobutanil	FALSE	11.72	179.0	Wide	90.0	Wide	20.5	30

Compound Name	ISTD	RT (min)	Precursor Ion	MS1 Resolution	Product Ion	MS2 Resolution	Dwell	CE (eV)
Myclobutanil	FALSE	11.72	150.0	Wide	123.0	Wide	20.5	15
Nitralin	FALSE	13.52	315.9	Wide	274.0	Wide	22.4	5
Nitralin	FALSE	13.52	299.7	Wide	257.9	Wide	22.4	5
Nitralin	FALSE	13.52	274.1	Wide	169.0	Wide	22.4	10
Nitrofen	FALSE	12.00	282.9	Wide	253.0	Wide	21.4	10
Nitrofen	FALSE	12.00	282.9	Wide	202.0	Wide	21.4	10
Nitrofen	FALSE	12.00	202.0	Wide	139.1	Wide	21.4	20
Nitrothal-isopropyl	FALSE	10.03	236.0	Wide	194.1	Wide	12.3	10
Nitrothal-isopropyl	FALSE	10.03	194.0	Wide	148.1	Wide	12.3	10
Nitrothal-isopropyl	FALSE	10.03	194.0	Wide	120.1	Wide	12.3	20
Norflurazon	FALSE	12.93	172.8	Wide	145.0	Wide	18.0	5
Norflurazon	FALSE	12.93	145.0	Wide	95.0	Wide	18.0	20
Norflurazon	FALSE	12.93	145.0	Wide	75.0	Wide	18.0	30
Omethoate	FALSE	6.75	156.0	Wide	110.0	Wide	43.6	10
Omethoate	FALSE	6.75	156.0	Wide	79.0	Wide	43.6	25
Omethoate	FALSE	6.75	110.0	Wide	79.0	Wide	43.6	15
Oxyfluorfen	FALSE	11.71	299.9	Wide	222.8	Wide	21.1	15
Oxyfluorfen	FALSE	11.71	252.0	Wide	196.0	Wide	21.1	20
Oxyfluorfen	FALSE	11.71	252.0	Wide	146.0	Wide	21.1	30
Paraoxon	FALSE	9.32	148.9	Wide	119.0	Wide	12.1	5
Paraoxon	FALSE	9.32	108.9	Wide	91.0	Wide	12.1	5
Paraoxon	FALSE	9.32	108.9	Wide	81.0	Wide	12.1	10
Paraoxon-methyl	FALSE	8.42	229.9	Wide	136.1	Wide	15.7	5
Paraoxon-methyl	FALSE	8.42	229.9	Wide	106.1	Wide	15.7	15
Paraoxon-methyl	FALSE	8.42	108.9	Wide	79.0	Wide	15.7	5
Parathion	FALSE	9.97	291.0	Wide	109.0	Wide	12.2	15
Parathion	FALSE	9.97	139.0	Wide	109.0	Wide	12.2	5
Parathion	FALSE	9.97	109.0	Wide	81.0	Wide	12.2	15
Parathion-d ₁₀	TRUE	9.90	301.0	Wide	115.0	Wide	15.9	15
Parathion-d ₁₀	TRUE	9.90	301.0	Wide	83.0	Wide	15.9	35
Parathion-methyl	FALSE	9.14	262.9	Wide	109.0	Wide	11.8	10
Parathion-methyl	FALSE	9.14	125.0	Wide	79.0	Wide	11.8	5
Parathion-methyl	FALSE	9.14	125.0	Wide	47.0	Wide	11.8	10
Penconazole	FALSE	10.54	248.0	Wide	192.1	Wide	10.4	15
Penconazole	FALSE	10.54	248.0	Wide	157.1	Wide	10.4	25
Penconazole	FALSE	10.54	159.0	Wide	89.0	Wide	10.4	35
Pentachloroaniline	FALSE	8.91	191.9	Wide	82.9	Wide	23.9	25
Pentachloroaniline	FALSE	8.91	158.0	Wide	123.0	Wide	23.9	15
Pentachloroaniline	FALSE	8.91	132.1	Wide	114.5	Wide	23.9	5
Pentachlorobenzene	FALSE	6.36	251.9	Wide	217.0	Wide	46.3	20
Pentachlorobenzene	FALSE	6.36	249.9	Wide	215.0	Wide	46.3	20
Pentachlorobenzene	FALSE	6.36	248.0	Wide	213.0	Wide	46.3	20
Pentachloronitrobenzene	FALSE	8.23	248.8	Wide	213.8	Wide	12.7	15
Pentachloronitrobenzene	FALSE	8.23	176.9	Wide	141.9	Wide	12.7	15
Pentachloronitrobenzene	FALSE	8.23	141.9	Wide	106.9	Wide	12.7	30
Phenothrin I	FALSE	14.29	183.0	Wide	168.0	Wide	71.4	10
Phenothrin I	FALSE	14.29	183.0	Wide	155.1	Wide	71.4	5

Compound Name	ISTD	RT (min)	Precursor Ion	MS1 Resolution	Product Ion	MS2 Resolution	Dwell	CE (eV)
Phenothrin I	FALSE	14.29	122.9	Wide	81.1	Wide	71.4	5
Picoxystrobin	FALSE	11.29	145.0	Wide	117.1	Wide	15.7	10
Picoxystrobin	FALSE	11.29	145.0	Wide	115.1	Wide	15.7	15
Picoxystrobin	FALSE	11.29	145.0	Wide	102.1	Wide	15.7	25
Piperonyl butoxide	FALSE	13.36	176.1	Wide	131.1	Wide	21.4	15
Piperonyl butoxide	FALSE	13.36	176.1	Wide	117.1	Wide	21.4	20
Piperonyl butoxide	FALSE	13.36	176.1	Wide	103.1	Wide	21.4	25
Pirimiphos-ethyl	FALSE	10.28	318.1	Wide	182.0	Wide	14.5	10
Pirimiphos-ethyl	FALSE	10.28	318.1	Wide	166.1	Wide	14.5	10
Pirimiphos-ethyl	FALSE	10.28	152.1	Wide	84.0	Wide	14.5	10
Profluralin	FALSE	8.11	346.9	Wide	330.1	Wide	13.8	5
Profluralin	FALSE	8.11	318.1	Wide	199.1	Wide	13.8	15
Profluralin	FALSE	8.11	318.1	Wide	55.1	Wide	13.8	15
Promecarb	FALSE	7.42	150.1	Wide	135.2	Wide	21.4	10
Promecarb	FALSE	7.42	135.1	Wide	115.1	Wide	21.4	15
Promecarb	FALSE	7.42	135.1	Wide	91.0	Wide	21.4	15
Prometon	FALSE	7.78	224.9	Wide	58.1	Wide	15.4	15
Prometon	FALSE	7.78	210.0	Wide	168.1	Wide	15.4	5
Prometon	FALSE	7.78	183.0	Wide	168.1	Wide	15.4	5
Prometryn	FALSE	9.28	241.0	Wide	184.2	Wide	11.6	10
Prometryn	FALSE	9.28	226.0	Wide	184.2	Wide	11.6	10
Prometryn	FALSE	9.28	199.0	Wide	184.1	Wide	11.6	5
Propargite	FALSE	13.32	149.9	Wide	135.1	Wide	18.8	5
Propargite	FALSE	13.32	135.0	Wide	107.1	Wide	18.8	10
Propargite	FALSE	13.32	135.0	Wide	77.1	Wide	18.8	30
Propazine	FALSE	7.95	229.1	Wide	214.2	Wide	14.9	5
Propazine	FALSE	7.95	229.1	Wide	58.1	Wide	14.9	10
Propazine	FALSE	7.95	214.2	Wide	172.2	Wide	14.9	10
Propham	FALSE	5.78	178.9	Wide	93.0	Wide	47.0	15
Propham	FALSE	5.78	136.9	Wide	93.0	Wide	47.0	10
Propham	FALSE	5.78	119.0	Wide	91.0	Wide	47.0	10
Propiconazole I	FALSE	12.93	172.9	Wide	145.0	Wide	18.0	15
Propiconazole I	FALSE	12.93	172.9	Wide	109.0	Wide	18.0	30
Propiconazole I	FALSE	12.93	172.9	Wide	74.0	Wide	18.0	45
Prosulfocarb	FALSE	9.37	251.0	Wide	128.2	Wide	14.3	5
Prosulfocarb	FALSE	9.37	128.0	Wide	86.1	Wide	14.3	0
Prosulfocarb	FALSE	9.37	91.0	Wide	65.0	Wide	14.3	15
Pyrazophos	FALSE	15.12	232.0	Wide	204.1	Wide	58.4	10
Pyrazophos	FALSE	15.12	221.0	Wide	193.1	Wide	58.4	10
Pyrazophos	FALSE	15.12	221.0	Wide	149.0	Wide	58.4	15
Pyridaphenthion	FALSE	13.80	340.0	Wide	199.0	Wide	17.5	5
Pyridaphenthion	FALSE	13.80	204.0	Wide	203.1	Wide	17.5	5
Pyridaphenthion	FALSE	13.80	188.0	Wide	82.0	Wide	17.5	10
Pyrimethanil	FALSE	8.28	198.0	Wide	183.1	Wide	13.0	15
Pyrimethanil	FALSE	8.28	198.0	Wide	158.1	Wide	13.0	20
Pyrimethanil	FALSE	8.28	198.0	Wide	118.1	Wide	13.0	35
Quinalphos	FALSE	10.73	157.0	Wide	129.1	Wide	11.6	15

Compound Name	ISTD	RT (min)	Precursor Ion	MS1 Resolution	Product Ion	MS2 Resolution	Dwell	CE (eV)
Quinalphos	FALSE	10.73	146.0	Wide	118.0	Wide	11.6	10
Quinalphos	FALSE	10.73	146.0	Wide	91.0	Wide	11.6	30
Quinoxifen	FALSE	12.92	306.8	Wide	237.0	Wide	15.6	20
Quinoxifen	FALSE	12.92	271.9	Wide	237.1	Wide	15.6	10
Quinoxifen	FALSE	12.92	237.0	Wide	208.1	Wide	15.6	30
Ronnel	FALSE	9.39	286.9	Wide	272.0	Wide	15.0	15
Ronnel	FALSE	9.39	285.0	Wide	269.9	Wide	15.0	15
Ronnel	FALSE	9.39	125.0	Wide	47.1	Wide	15.0	15
Secbumeton	FALSE	8.39	196.0	Wide	122.1	Wide	14.0	10
Secbumeton	FALSE	8.39	196.0	Wide	85.0	Wide	14.0	10
Secbumeton	FALSE	8.39	169.0	Wide	154.1	Wide	14.0	5
Silafluofen	FALSE	16.92	286.0	Wide	258.1	Wide	99.1	10
Silafluofen	FALSE	16.92	179.2	Wide	151.1	Wide	99.1	10
Silafluofen	FALSE	16.92	179.2	Wide	91.1	Wide	99.1	20
Simazine	FALSE	7.81	201.1	Wide	173.1	Wide	15.3	5
Simazine	FALSE	7.81	173.0	Wide	172.1	Wide	15.3	5
Simazine	FALSE	7.81	173.0	Wide	138.2	Wide	15.3	5
Simetryn	FALSE	9.16	213.0	Wide	185.1	Wide	11.3	5
Simetryn	FALSE	9.16	213.0	Wide	170.1	Wide	11.3	10
Simetryn	FALSE	9.16	169.9	Wide	155.0	Wide	11.3	5
Spiromesifen	FALSE	13.71	273.0	Wide	255.1	Wide	18.4	5
Spiromesifen	FALSE	13.71	272.0	Wide	254.2	Wide	18.4	5
Spiromesifen	FALSE	13.71	272.0	Wide	209.2	Wide	18.4	10
Terbufos	FALSE	8.16	230.9	Wide	175.0	Wide	12.7	10
Terbufos	FALSE	8.16	230.9	Wide	129.0	Wide	12.7	20
Terbufos	FALSE	8.16	152.9	Wide	97.0	Wide	12.7	5
Terbumeton	FALSE	7.96	225.1	Wide	169.2	Wide	14.6	0
Terbumeton	FALSE	7.96	169.0	Wide	154.1	Wide	14.6	5
Terbumeton	FALSE	7.96	169.0	Wide	141.1	Wide	14.6	5
Terbuthylazine	FALSE	8.12	228.9	Wide	173.1	Wide	13.3	5
Terbuthylazine	FALSE	8.12	172.9	Wide	172.0	Wide	13.3	5
Terbuthylazine	FALSE	8.12	172.9	Wide	138.1	Wide	13.3	5
Terbutryn	FALSE	9.51	241.1	Wide	170.2	Wide	19.3	15
Terbutryn	FALSE	9.51	185.0	Wide	170.1	Wide	19.3	5
Terbutryn	FALSE	9.51	185.0	Wide	111.1	Wide	19.3	15
Tetrachlorvinphos	FALSE	11.13	329.0	Wide	108.9	Wide	18.3	25
Tetrachlorvinphos	FALSE	11.13	109.0	Wide	78.9	Wide	18.3	5
Tetrachlorvinphos	FALSE	11.13	78.9	Wide	47.0	Wide	18.3	10
Tetradifon	FALSE	14.40	226.9	Wide	199.0	Wide	39.9	15
Tetradifon	FALSE	14.40	158.9	Wide	131.0	Wide	39.9	10
Tetradifon	FALSE	14.40	158.9	Wide	111.0	Wide	39.9	20
Tetramethrin I	FALSE	13.79	164.0	Wide	107.1	Wide	17.5	10
Tetramethrin I	FALSE	13.79	164.0	Wide	77.1	Wide	17.5	25
Tetramethrin I	FALSE	13.79	123.0	Wide	81.1	Wide	17.5	10
Thionazin	FALSE	6.82	175.0	Wide	79.0	Wide	39.5	10
Thionazin	FALSE	6.82	143.0	Wide	79.0	Wide	39.5	10
Thionazin	FALSE	6.82	107.1	Wide	79.0	Wide	39.5	15

Compound Name	ISTD	RT (min)	Precursor Ion	MS1 Resolution	Product Ion	MS2 Resolution	Dwell	CE (eV)
THPI	FALSE	6.01	151.0	Wide	122.0	Wide	38.8	10
THPI	FALSE	6.01	151.0	Wide	79.0	Wide	38.8	10
Tolclofos-methyl	FALSE	9.23	267.0	Wide	252.0	Wide	10.8	15
Tolclofos-methyl	FALSE	9.23	267.0	Wide	93.0	Wide	10.8	30
Tolclofos-methyl	FALSE	9.23	125.0	Wide	79.0	Wide	10.8	5
Tolyfluanid	FALSE	10.63	238.0	Wide	137.0	Wide	7.7	15
Tolyfluanid	FALSE	10.63	137.0	Wide	91.1	Wide	7.7	20
Tolyfluanid	FALSE	10.63	137.0	Wide	65.0	Wide	7.7	35
Tralkoxydim	FALSE	14.75	137.0	Wide	109.0	Wide	46.3	5
Tralkoxydim	FALSE	14.75	137.0	Wide	57.0	Wide	46.3	10
Tralkoxydim	FALSE	14.75	109.0	Wide	57.0	Wide	46.3	5
Transfluthrin	FALSE	9.12	165.1	Wide	91.1	Wide	12.6	10
Transfluthrin	FALSE	9.12	163.1	Wide	143.1	Wide	12.6	20
Transfluthrin	FALSE	9.12	163.1	Wide	91.1	Wide	12.6	10
Triadimefon	FALSE	10.00	208.0	Wide	181.1	Wide	12.2	5
Triadimefon	FALSE	10.00	208.0	Wide	111.0	Wide	12.2	20
Triadimefon	FALSE	10.00	128.0	Wide	65.0	Wide	12.2	20
Triazophos	FALSE	12.64	161.2	Wide	134.2	Wide	39.4	5
Triazophos	FALSE	12.64	161.2	Wide	106.1	Wide	39.4	10
Triazophos	FALSE	12.64	161.2	Wide	91.0	Wide	39.4	15
Trichloronat	FALSE	10.20	298.8	Wide	270.9	Wide	13.1	10
Trichloronat	FALSE	10.20	296.8	Wide	268.9	Wide	13.1	10
Trichloronat	FALSE	10.20	268.9	Wide	223.0	Wide	13.1	20
Trifluralin	FALSE	7.25	306.1	Wide	264.0	Wide	20.0	5
Trifluralin	FALSE	7.25	264.0	Wide	206.0	Wide	20.0	5
Trifluralin	FALSE	7.25	264.0	Wide	160.1	Wide	20.0	15
Triphenyl phosphate	TRUE	13.35	326.0	Wide	325.0	Wide	19.6	5
Triphenyl phosphate	TRUE	13.35	232.9	Wide	215.1	Wide	19.6	10
Triphenyl phosphate	TRUE	13.35	214.9	Wide	168.1	Wide	19.6	15
Vinclozolin	FALSE	9.11	212.0	Wide	172.1	Wide	14.2	15
Vinclozolin	FALSE	9.11	197.9	Wide	145.0	Wide	14.2	15
Vinclozolin	FALSE	9.11	187.0	Wide	124.0	Wide	14.2	20

www.agilent.com

DE26464995

This information is subject to change without notice.

© Agilent Technologies, Inc. 2022
 Printed in the USA, July 6, 2022
 5994-5108EN



Learn more:

www.agilent.com/chem/5977b

www.agilent.com/chem/7000d-triple-quadrupole-gc-ms

www.agilent.com/chem/7010b-triple-quadrupole-gc-ms

Buy online:

www.agilent.com/chem/store

Find a local Agilent customer center in your country:

www.agilent.com/chem/contactus

U.S. and Canada

1-800-227-9770

agilent_inquiries@agilent.com

Europe

info_agilent@agilent.com

Asia Pacific

inquiry_lsca@agilent.com

DE79149067

This information is subject to change without notice.

© Agilent Technologies, Inc. 2023
Published in the USA, May 12, 2023
5994-5900EN

