

Packed Column GC Troubleshooting Guide: How to Locate Problems and Solve Them

By applying a systematic approach to troubleshooting, you can solve many GC problems on your own. The real task is identifying the cause of a problem in the shortest possible time. This guide outlines techniques that will enable you to troubleshoot your problem step-by-step. You'll reduce repair costs and instrument downtime.

Suggestions for Effective Troubleshooting

There are five major sources of problems in gas chromatography: (1) the operator, (2) the sample, (3) the column, (4) the equipment or electronics, and (5) the gas flow system. Eliminate these sources in a systemic manner to isolate the cause of a problem.

A few basic rules make troubleshooting faster and easier. Most important are maintaining close observation of operating parameters and a good record keeping system (temperatures, flow rates, chart speeds, column type, stationary phase type and amount, solid support type and mesh size, etc.) Also of primary importance are reference chromatograms and reference standards containing known concentrations of the components in your samples, with no extraneous components. Many hours can be wasted hunting problems within an instrument or column, when the problem is, in fact, the sample being analyzed. If your chromatographic system separates the reference standard well and reproducibly, any problem most likely is related to the sample.

Your troubleshooting will progress more smoothly if you also have on hand:

1. *A duplicate analytical column – one you know will provide acceptable separation under proper conditions*

Try this duplicate column in your malfunctioning system. If it corrects your problem, the problem is related to the original column.

2. *A new syringe, to help isolate the source of ghost peaks*

Repeat the analysis with a new, clean syringe. If your trouble disappears, the problem is isolated to a defective or dirty syringe used during the original analysis.

3. *Leak detection aids*

Use these to ensure that your entire system is free of leaks, as is mandatory for proper operation. We strongly recommend using electronic leak-detecting units, rather than liquids.

4. *Spare septa and high temperature septa*

These help to identify problems with reproducibility or ghost peaks caused by a leaking or bleeding septum. Replace your septum with a new duplicate septum, or with a higher temperature septum. If the symptom disappears, the trouble was a leaking or bleeding septum.

5. *Detector cleaner*

A dirty detector creates noisy baselines. Flame ionization detectors (FIDs) can be cleaned by using either Freon® TF, an in-place cleaner, or an ultrasonic bath filled with an immersion cleaner.

6. *Thermometer*

To verify the oven temperature, ruling out defective temperature control.

7. *Spare ferrules*

To eliminate leaks in connections.

8. *Flow meter*

To check gas flows.

9. *Spare recorder and electrometer cables*

To eliminate the recording system as a source of trouble.

10. *Instrument manual*

Isolating the Problem Source

To define your problem, refer to the Symptoms Index on page 4. Locate your trouble symptom (e.g., broad peaks, unresolved peaks, long retention times), then go to the appropriate point in the Troubleshooting Table (pages 5-18). If there is more than one symptom, note the possible cause for each. If one cause is common to all symptoms, this most likely is the source of your problem. Note that while the troubleshooting table contains most of the symptoms you will encounter, it cannot cover all potential problems. When you cannot find a rapid solution by using the troubleshooting table, you must systematically isolate the trouble by sequentially eliminating the five potential sources of the problem:

1. Rule out *operator error* by double checking all operating parameters, such as temperature, carrier gas flow, column description, etc.
2. Check for a *sample problem* by injecting a reference standard. If you get a good chromatogram, the problem most likely is sample related. If the chromatogram is not satisfactory, the problem probably is column or instrument related.
3. Check for a *column problem* by replacing the column with a duplicate column, one known to provide good results under proper conditions. If results are good, the problem is related to the original column. If the symptom persists, the problem is related to the instrument.
4. Isolate *equipment related problems* by listing the equipment systems which can cause the observed symptoms (e.g., broad peaks with long retention times can be caused by problems in (1) carrier gas system, (2) column heating

system, or (3) injection port heating system). Next, isolate the problem by examining each suspected system.

Isolate possible *electronic system malfunctions* (detector, electrometer, recorder, wiring) by performing the following checks. If your instrument is equipped with dual channels (detector, electrometer, recorder, etc.) see paragraph (c).

(a)

Check the recorder by setting the gas chromatograph attenuation to infinity. The recorder pen should go to electronic zero. If the symptom (baseline drift, noise, etc.) disappears, the recorder is not the problem. If the symptom continues, refer to the recorder instruction manual.

(b)

To isolate the detector (FID) as the source of trouble, turn off the instrument and disconnect the cable (at the detector end) from the detector to the electrometer. If the symptom disappears when power is on, the problem is in the detector. If the symptom continues, disconnect the same cable at the electrometer. If the symptom *now* disappears, the cable is defective. If the symptom still continues, refer to the electrometer instrument manual. (Note: To prevent inducing extraneous noise onto the cable, it may be necessary to install a coaxial cap on the free end.)

(c)

If your chromatograph is equipped with dual detector channels, you have a simple but effective alternate means of identifying the problem source. If the symptom occurs in channel A, disconnect at the detectors the cables which connect channels A and B detector outputs to channels A and B electrometer inputs (Figure A). Reconnect the cable from electrometer B input to detector A output. This applies the signal from the channel A detector output to the channel B electrometer input and recorder. If the symptom does not appear on recorder channel B after this cable change, either the channel A electrometer, recorder, or cable(s) is defective. If the symptom is not eliminated, the channel A detector is the problem source.

- To check the carrier gas system for possible problems, refer to the following section, *Checking the Carrier Gas System*.

Figure A. Checking for an Electronics Problem in a Chromatograph Equipped with Dual Detector Channels

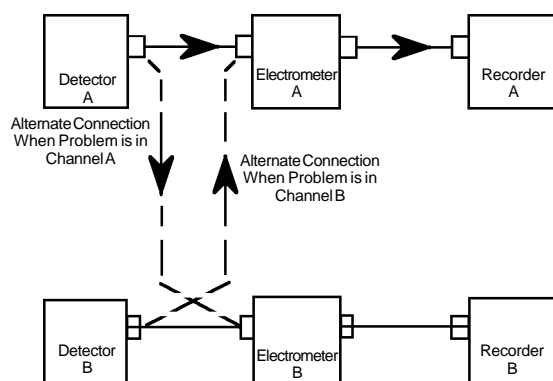

Checking the Carrier Gas System

A typical carrier gas system is illustrated in Figure B. The most common problem in this system is insufficient carrier gas flow through the chromatographic column. This generally is caused by (1) insufficient source pressure, (2) leaks, and/or (3) an unusually large pressure drop across one of the components in the system.

Verify the column carrier gas flow at the detector exit, using a flow meter. We do not recommend using a rotameter for measuring gas flow because a specific rotameter is required for each type of gas used, and rotameters exhibit a linear response with pressure changes.

When using a bubble flow meter, use the following equation to verify that the carrier gas flow rate is properly adjusted:

$$\text{Time (sec)} = \frac{\text{Volume Observed (cc)} \times 60 \text{ sec/min}}{\text{Desired Flow (cc/min)}}$$

Where: Time (sec.) = time required for bubble to travel observed distance.

Volume Observed = volume indicated by soap bubble flow meter.

Desired Flow = rate specified by method being used.

Example: Obtain a flow rate of 20cc/min, using a 10cc soap bubble meter.

$$\text{Time (sec)} = \frac{10\text{cc} \times 60 \text{ sec/min}}{20\text{cc/min}}$$

$$\text{Time} = 30\text{sec}$$

If the time required is not equal to the calculated time, adjust the carrier gas flow rate. If sufficient flow cannot be obtained by adjusting the flow control valve, the problem probably is due to inadequate source pressure (measured at P1 in Figure B). Increasing this pressure usually will provide adequate flow. Normally, a source pressure of 60psig is sufficient for 6-12 foot columns. Increasing the column length, oven temperature, and/or flow rate will require raising the source pressure. The source pressure is particularly important if you are using a temperature program, since the pressure must be 10-15psig in excess of the column pressure drop at the maximum temperature. This pressure difference allows the differential flow controller to function properly. If the correct pressure difference is not maintained, carrier gas flow will drop drastically at elevated temperatures.

Other common causes of inadequate gas flow are leaks in the system and a large pressure drop across one or more of the system components. The use of pressure gauges can save considerable time when isolating these problems. Common leak points are column connections, the septum, and connections for the various valves and gas purifiers.

A pressure gauge installed between the flow control valve injection port (P3 in Figure B) indicates column head pressure. A low reading at this point indicates a leak between P3 and the detector outlet (e.g., a defective column, septum, etc.) or a large pressure drop across an upstream component (e.g., a plugged gas purifier). Alternatively, an OMI™ Indicating Purifier will tell you at a glance whether leaks are present (see products pages). A high pressure reading at P3 indicates an over-tightened septum, dirty detector, too-tightly packed column, etc. Low pressure readings on a pressure gauge at P2 will reveal an exhausted High Capacity Gas

Purifier (larger than normal pressure drop). Routine observation of this pressure will enable you to determine when the gas purifier should be changed.

NOTE: Many chromatographs have an intentional crimp in the carrier gas line between the flow controller and the injection port, or employ capillary tubing with a small internal diameter. Consequently, the pressure reading at point P3 will be different from the column head pressure reading taken through the septum. These restrictions also can make it difficult to obtain sufficient carrier gas flow, particularly when converting an instrument for use with capillary columns.

Testing for Leaks

The most common method of leak testing is to apply a liquid (e.g., Snoop® or HT-Leak Detector) and watch for bubbles to appear. These liquids can be aspirated into the GC system, however, and can cause unstable baselines and ghost peaks in subsequent chromatograms. To eliminate the risk of contamination, use a thermal conductivity leak detector, such as a GOW-MAC unit. These units are extremely sensitive to helium or hydrogen leaks, and are equal to liquids in sensitivity for nitrogen and other heavy gases.

A simple technique for detecting septum leaks, while avoiding contamination, is to use a Supelco™ Leak Tester – a plastic tube with conical ends. When one end is dipped in Snoop, capillary action pulls a small amount of the liquid into the tube. If a leak is present, bubbles appear at this end when the opposite end is pressed against the septum nut. Because the liquid does not contact the instrument, there is no risk of contamination.

Problems Related to Column and Septum Removal and Installation

Improperly installed columns and septa are a frequent source of leaks, and are the most common cause of glass column breakage. An incorrectly tightened septum nut presents problems such as excessive septum bleed, premature septum leaks, and low carrier gas flow rates. We offer two torque wrenches to help ensure correct installation of columns and septa. The Glasrench™, used for installing columns, is available in two torque settings to provide the correct torque for the various types of ferrules. The Supelco septum nut torque wrench ensures that the correct torque is consistently applied when installing septum nuts. These tools save time and money by eliminating over-tightening, minimizing leaks and column breakage.

When changing columns or septa, it is important that you first turn off the chromatograph oven and allow the column to cool for 10-15 minutes, then turn off the carrier gas. This procedure protects

your column in two ways: allowing the column to cool before turning off the carrier gas prevents oxidation of the column packing, which can occur when a hot column is exposed to oxygen in the air. Allowing the column pressure to drop to ambient pressure prevents the packing from blowing out of the column ends. A sudden change in pressure, when a column or a septum is removed with the carrier gas flowing, can blow packing from the column.

NOTE: When storing columns, cap the ends with metal Swagelok® caps to prevent diffusion of air into the column (and subsequent oxidation). *Plastic caps do not prevent diffusion of air into a column.*

Sample Injection

Improper sample injection can cause many problems in gas chromatography. To ensure that your injections are accurate and reproducible, we recommend the following general guidelines and procedures:

- A. *Syringe Size:* Always use a syringe large enough that the desired sample volume does not fill it to capacity, and small enough that the sample volume is not less than approximately 10% of its capacity.
- B. *Injection Technique:* Sample injection should be smooth and rapid, with quick removal of the syringe after injection, in order to avoid peak broadening.
- C. *Sample Size Reproducibility:* Many problems in chromatography result from difficulties in reproducing the size of a sample. Some techniques which will help ensure reproducible samples are:
 - 1) *Automatic Injectors:* These devices improve sample reproducibility by virtue of consistent mechanical operation. Each step (sampling, sample injection, syringe cleaning) is repeated precisely.
 - 2) *Sampling Valve Injection:* Sample size is determined solely by sample loop size, and injection is rapid and precise. Reproducibility is improved because chances for variability are greatly reduced.
 - 3) *Solvent Flush Technique:* This technique (Figure C) reduces the problem of irreproducible injection volumes when making syringe injections by hand.
 - a) Eliminate sample hang-up in the needle by first cleaning the syringe, then drawing in a small aliquot of solvent.
 - b) Remove the syringe from the solvent and draw in a small amount of air.
 - c) Draw in the desired amount of sample.

Figure B. Typical Carrier Gas System

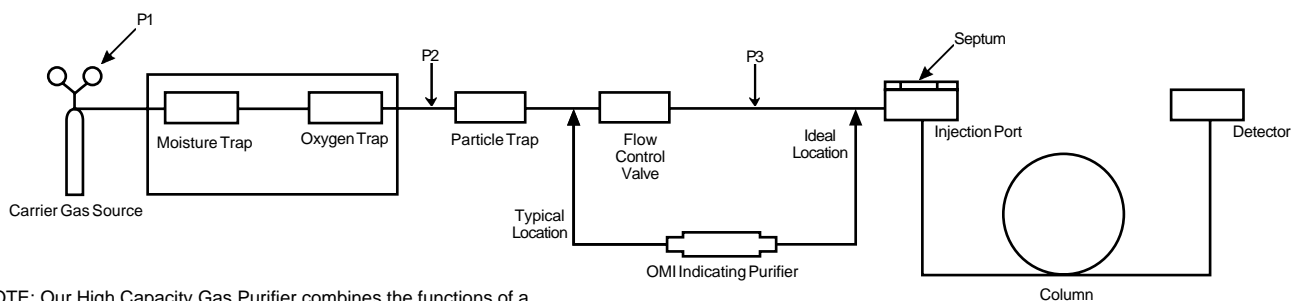

*NOTE: Our High Capacity Gas Purifier combines the functions of a moisture trap and an oxygen trap (see products pages).

G001131

- d) Remove the syringe from the sample and draw in a little more air.
 - e) Verify the amount of sample in the syringe barrel. This is only possible with syringes that do not have plungers in the needle.
 - f) Quickly and smoothly inject sample into the chromatograph.
- 4) *Syringes with Needle Plungers:* Improve sample reproducibility by using a syringe with a plunger in the needle. This eliminates sample retention in the needle dead volume. The solvent flush technique, above, may be useful, since a small amount of sample hang-up can still occur.

Figure C. Solvent Flush Technique

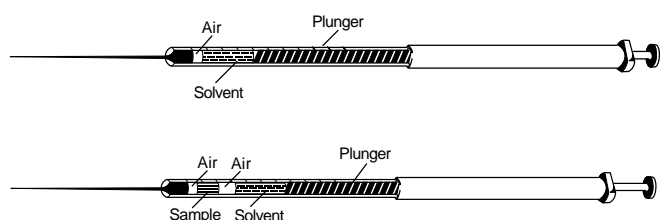

G001132,1133

Other Useful Publications

In addition to the information presented in this guide, helpful tips to save time and money in chromatography are offered in the following FREE Supelco technical literature:

Bulletin 741

The ideal ferrule provides a leak-tight seal, accommodates column OD variations, seals with minimum torque, and does not stick to the column or fitting. This bulletin offers valuable information about choosing the best ferrule for various applications.

Bulletin 783

Provides instructions for cleaning dirty flame ionization detectors (FIDs) and offers hints to help prevent contamination.

Bulletin 898

Provides valuable information about installing and troubleshooting gas delivery systems for single GC or multiple GC systems.

Bulletin 918

The best gas purifier system includes multiple purifiers that help protect each other while protecting columns and detectors. This bulletin includes information needed to select suitable purifiers for carrier gas, and for air and hydrogen used as fuel gases.

Publication 395082

Leak-resisting, low bleed septa improve baseline stability and reduce the occurrence of leak-associated problems. This publication describes tests that show Thermogreen LB-2 septa exhibit low bleed at inlet temperatures up to 350°C.

Gas Chromatography Troubleshooting Table

Abbreviations

- ECD – electron capture detector
- FID – flame ionization detector
- FPD – flame photometric detector
- NPD – nitrogen phosphorous detector
- TCD – thermal conductivity detector

Symptoms Index

Symptom	Symptom No.
Baseline	
changing	23
cycling	9
dip	25,26
drift	7
drop	24
noise	8
off scale (zeroing problem)	6
rise	22
spikes, irregular	11
spikes, regular	10
Carrier Gas	
low flow rate	32
Column Life	
short	33
Column Packing	
compacted	31
gaps in	30
Detector Response	
low	3,4
Peak Shapes Incorrect	
cigar top	20
clipped	21
round top	19
skewed (leading edge)	16
split	17
square top	18
tailing	15
Peaks	
broad (solvent)	27
missing (all)	1
missing (some)	2
negative	12
random extra peaks	14
sample memory peaks	13
unresolved	29
Quantification	
irreproducible	5
Retention Time	
prolonged or shortened	28

Troubleshooting Table

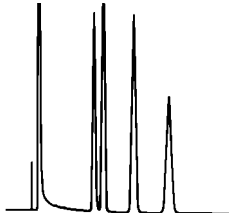
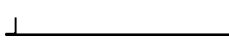
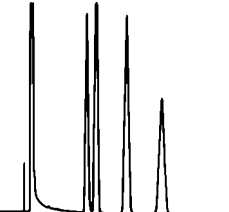
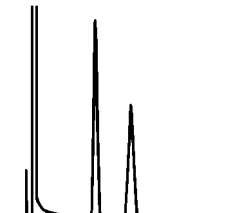
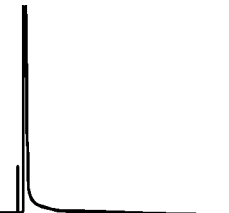
Symptom	Possible Cause	Remedy
Symptom No. 1: No Peaks		
 <p>Normal</p>  <p>Problem</p> <p style="text-align: right;">795-0314</p>	<ol style="list-style-type: none"> 1. Detector or electrometer power off / fuse blown. 2. Sample injected in wrong column (multiple-column chromatograph). 3. FID not lit. 4. No carrier gas flow. 5. Defective syringe. 6. Column or septum leak. 7. Injection port temperature too low – sample not vaporized. 8. Defective recorder. 9. Defective detector, electrometer, or cable. 10. Bad connection between FID collector and voltage source. 	<ol style="list-style-type: none"> 1. Check detector, electrometer settings, and fuses. 2. Reinject sample in proper column. 3. Use mirror over exhaust to check FID. If lit, water condenses on mirror. If not lit, light flame. Check hydrogen and air flows. 4. Measure flow at detector or column exit. If no flow, check for leaks or obstructions at column connection and septum. 5. Replace syringe. 6. Replace septum. Check column connections. 7. Increase injection port temperature (but not in excess of liquid phase temperature limit) or inject sample directly onto column packing. 8. Check recorder connections. Check recorder zero. Troubleshoot recorder according to instruction manual. 9. Check collector voltage and connections per instrument manual. 10. Check collector spring clip connection.
Symptom No. 2: Missing Peaks / Solvent Peak Only		
 <p>Normal</p>  <p>Problem</p> <p style="text-align: right;">795-0315</p>  <p>Problem</p> <p style="text-align: right;">795-0317</p>	<ol style="list-style-type: none"> 1. Sample too dilute. 2. Column or septum leak. 3. Incorrect temperatures: <ol style="list-style-type: none"> (a) Injection port or column temperature too low, sample not vaporized. (b) Injection port temperature too high for thermally labile compounds. (c) Column temperature too high, sample eluting in solvent peak 4. Flow rate incorrect. 5. Sample adsorption by column or glass wool. 6. Column cannot separate components from solvent. 	<ol style="list-style-type: none"> 1. Check system by injecting standard. If okay, increase sensitivity or inject larger or more concentrated sample. 2. Check for leaks (see page 3). Tighten connections. Replace septum. 3. <ol style="list-style-type: none"> (a) Ensure column temperature setting is correct for column being used and sample being analyzed, then verify that oven is operating at selected temperature. Increase temperature if necessary. (b) Decrease injection port temperature. (c) Decrease column temperature. 4. Measure flow rate, adjust if necessary (see page 2). 5. Inject standard on known good column. If okay, original column is bad. Use properly treated glass wool (i.e., H₃PO₄ for free acid analysis, silicone-treated for other compounds). If sample has never been analyzed and is chemically active, you may need a special column. 6. Change column or solvent.

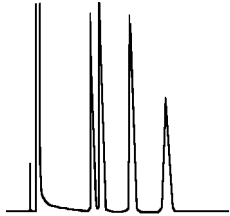
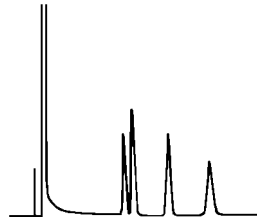
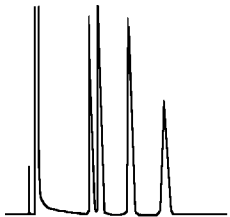
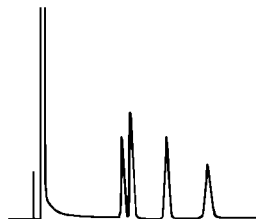
Symptom	Possible Cause	Remedy
Symptom No. 3: Low Detector Response (all peaks; retention times correct)		
 <p>Normal</p>  <p>Problem</p> <p style="text-align: right;">795-0316</p>	<ol style="list-style-type: none"> 1. Poor injection technique. 2. Sensitivity setting wrong or sample too small. 3. Defective syringe. 4. Septum leak. 5. Injection port temperature too low for sample. 6. FID only: low hydrogen flow or air flow incorrect. 7. FID only: low oxygen level in compressed air. 8. FID only: faulty connection between FID collector and voltage source. 9. Dirty ECD. 10. For TCD: <ol style="list-style-type: none"> (a) Carrier gas flow rate incorrect. (b) Cell voltage incorrect. 11. Sample adsorbed by column, glass wool, tubing, etc. 12. FPD only: hydrocarbon eluting with sample, causing diminished response due to quenching effect. 	<ol style="list-style-type: none"> 1. Use correct syringe size; use solvent flush technique (see pages 3 and 4). 2. Check, correct if necessary. Inject standard for comparison. 3. Use new syringe. 4. Replace septum. 5. Increase injection port temperature. 6. Measure flows, correct if necessary. 7. Replace air tank. 8. Clean collector spring clip with emery paper. 9. Clean per instrument manual. 10. (a) Measure flow, adjust if necessary (see page 2). (b) Refer to instrument manual. 11. Use deactivated column materials. 12. Check with hydrocarbon free standard; change to column that will separate hydrocarbons from components of interest.
Symptom No. 4: Low Detector Response (all peaks; retention times too long)		
 <p>Normal</p>  <p>Problem</p> <p style="text-align: right;">795-0316</p>	<ol style="list-style-type: none"> 1. Low carrier gas flow rate. 2. Carrier gas leak at septum or column connections. 3. Column temperature too low. 4. Column worn out or conditioned at too high a temperature. 	<ol style="list-style-type: none"> 1. Measure flow, adjust if necessary (see page 2). 2. Check for leaks, correct if necessary (see page 3). 3. Increase column temperature. 4. Verify column temperature and stationary phase temperature limits. Analyze sample on known good column. Repack first 6" of column or replace column.



Symptom	Possible Cause	Remedy
Symptom No. 5: Quantification Not Reproducible		
<p>a. Retention times correct. Components with longest retention times show low values when using normalization techniques.</p> <p>b. Retention times correct. Different components not yielding similar peak areas for same amount.</p> <p>c. Quantification varies for one component eluting over wide time span, even using internal standard technique.</p> <p>d. Inconsistent quantification for same sample on successive analyses.</p> <p>e. Low values for minor compounds.</p> <p>f. Increased peak response with successive injections.</p>	<p>1. Wrong sample.</p> <p>a1. Incomplete sample injection.</p> <p>a2. Injection port or column temperature too low.</p> <p>a3. Incorrect slope sensitivity with electronic integrator.</p> <p>b1. Differing detector response for different components.</p> <p>b2. Adsorption of components by packing, glass wool, tubing, or transfer lines</p> <p>c1. Internal standard not compensating for all components in sample.</p> <p>c2. Slope sensitivity of integration not high enough for late eluters.</p> <p>d. Insufficient resolution of peaks, or peak tailing.</p> <p>e. Sample too small for accurate counting by integrator.</p> <p>f. Adsorption of components and saturation of active sites with sample (priming the column).</p>	<p>1. Verify using known standard.</p> <p>a1. Use solvent flush technique (see pages 3 and 4).</p> <p>a2. Increase temperature</p> <p>a3. Adjust slope sensitivity.</p> <p>b1. Determine correction factors and/or use internal standards technique.</p> <p>b2. Use deactivated system.</p> <p>c1. Use multiple internal standards.</p> <p>c2. Use multiple internal standards.</p> <p>d. Modify operating parameters or replace column to improve resolution and eliminate tailing.</p> <p>e. Increase sample size or electrometer range setting.</p> <p>f. Use deactivated system.</p>

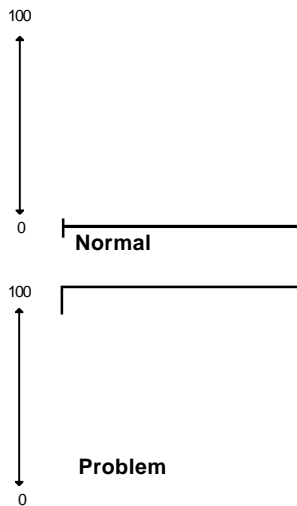



Symptom No. 6: Baseline OffScale, Cannot Zero

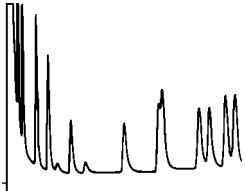
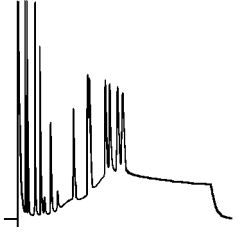
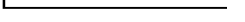

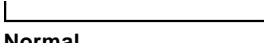

795-0318

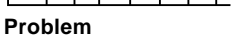
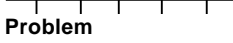
- | | |
|--|--|
| <ol style="list-style-type: none"> Column not conditioned properly, or contaminated, or temperature too high. Recorder problem. Septum leak. Wrong gas (e.g., argon/methane with FID). Contamination. Too much/too little gas flow. TCD: imbalance in column flow. Contaminated detector (e.g., NPD contaminated with Snoop, ECD contaminated with chlorinated solvents). Electrometer or detector problem. | <ol style="list-style-type: none"> Reduce column temperature to ambient. If baseline normal, check system with good column. If okay, recondition original column. Set attenuation to infinity. If recorder does not go to electrical zero, troubleshoot recorder per manual. Check for leaks, correct if necessary (see page 3). Verify gases are correct for instrument and detector as specified in manual. Turn off injection port heat. If zeroing capability returns, clean injection port liners, etc. Check flow, adjust to within manual specifications. Check flow, adjust as necessary. Avoid sources of contamination. Troubleshoot per instrument manual. |
|--|--|

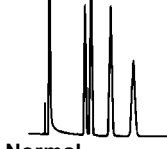
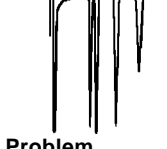

Symptom	Possible Cause	Remedy
Symptom No. 7: Baseline Drift		
 <p>Normal</p>  <p>Problem</p> <p>795-0319</p>	<ol style="list-style-type: none"> Carrier gas flow changing with temperature during emperature programming. Septum or column leak. Septum bleed or septum fragments in column. Column bleed or contamination. Gas flows not within minimum/ maximum limits (including hydrogen and air for FID) or poorly related flow. Insufficient instrument warm-up time or temperature equilibration time. Defective electrometer or detector. Contaminated detector or injection port. 	<ol style="list-style-type: none"> Increase source pressure to 15psig above column head pressure. Check, correct as necessary (see page 3). Replace septum with higher temperature type; repack column inlet. Replace column with known good column. If results okay, recondition original column. Measure flows and verify against manual specifications. Allow time for instrument to equilibrate when changing operating temperature or installing another column. Troubleshoot per <i>Isolation of Problem Source</i> (see page 1). Clean as recommended in instrument manual.
Symptom No. 8: Irregular or Unstable Baseline (baseline noise)		
 <p>Normal</p>  <p>Problem</p> <p>795-0323</p>	<ol style="list-style-type: none"> Column bleed or contamination. Contaminated detector or injection port. Carrier gas leak. Poor carrier gas regulation. Gas impurities/contaminated gas line. Gas flows not within minimum/ maximum limits (including hydrogen and air for FID) or poorly regulated flow. Defective electrometer, detector, or cable. FID only: collector incorrectly aligned. ECD only: heater wire too close to detector wire, causing AC noise. 	<ol style="list-style-type: none"> Replace column with known good column; if results okay, recondition original column. Clean detector and/or injection port. Check for leaks, correct as necessary (see page 3). Check gas supply for sufficient pressure. Replace tank if near empty. Change gas tank, clean metal tubing, use gas purifier(s). Measure flows and verify against manual specifications. Troubleshoot per <i>Isolation of Problem Source</i> (see page 1). Realign as required. Reposition heater wire.

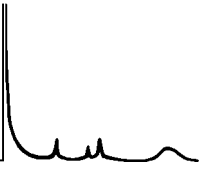
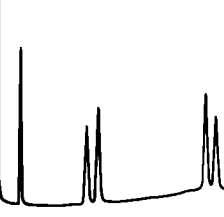
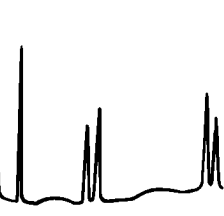
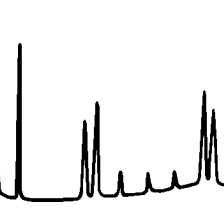

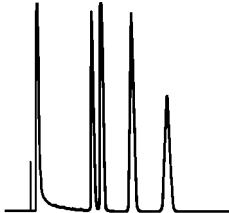
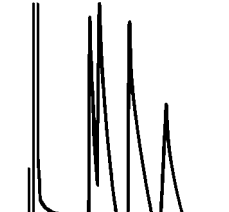
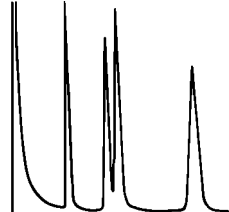
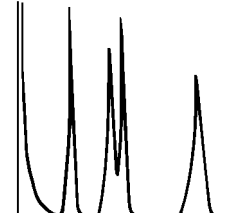
Symptom	Possible Cause	Remedy
Symptom No. 9: Cycling Baseline Drift		
 <p>Normal</p>  <p>Problem</p> <p style="text-align: right;">795-0324</p>	<ol style="list-style-type: none"> 1. Poor instrument location (drafts, changes in ambient temperature, etc.). 2. Defective detector temperature controller. 3. Defective oven temperature controller. 4. Carrier gas flow irregular: insufficient supply pressure. 5. Defective carrier gas regulator. 6. Defective carrier gas flow controller. 7. If using pumped gases, such as from hydrogen generator: sensitivity too high. 	<ol style="list-style-type: none"> 1. Close windows, relocate instrument, etc. 2. Replace temperature sensing probe. 3. Replace temperature sensing probe. 4. Change gas tank. 5. Replace regulator. 6. Replace flow controller. 7. Reduce detector sensitivity or decrease output pressure from generator.
Symptom No. 10: Spikes (regular)		
 <p>Normal</p>  <p>Problem</p>  <p>Problem</p> <p style="text-align: right;">795-0320</p>	<ol style="list-style-type: none"> 1. Condensate or dust particles in FID. 2. Contaminated gases. 3. Defective electronics or detector 	<ol style="list-style-type: none"> 1. Clean detector, check column ends to ensure glass wool is in place. 2. Replace gases or insert liquid nitrogen trap in gas line. 3. Check recorder cables and detector/electrometer cables. Troubleshoot electronics and detector per <i>Isolation of Problem Source</i> (see page 1).
Symptom No. 11: Spikes (irregular or erratic)		
 <p>Normal</p>  <p>Problem</p> <p style="text-align: right;">795-0321</p>	<ol style="list-style-type: none"> 1. Defective cable, intermittent shorting. 2. ECD: heater wire and detector wire too close, or loose. 3. FID: insufficient hydrogen flow. 4. Electronic interference from external source. 	<ol style="list-style-type: none"> 1. Replace cable. 2. Check wire position, relocate if necessary. 3. Increase flow. 4. Relocate instrument, determine possible interference sources (nearby transmitter site, etc.).
Symptom No. 12: Negative Peaks		
 <p>Normal</p>  <p>Problem</p> <p style="text-align: right;">795-0322</p>	<ol style="list-style-type: none"> 1. Recorder improperly connected, polarity reversed, or sample injected into wrong column. 2. TCD only: impurity in carrier gas. 	<ol style="list-style-type: none"> 1. Reverse recorder connections or polarity switch. 2. Install or replace carrier gas purifier(s).

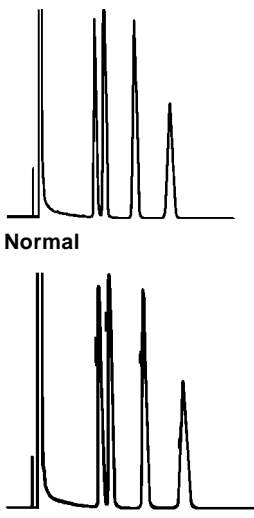
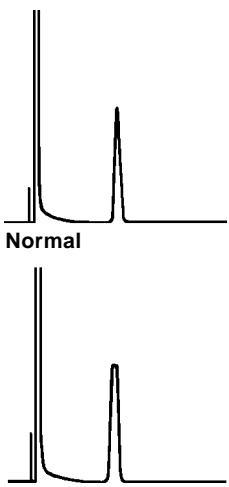
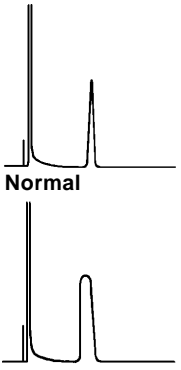

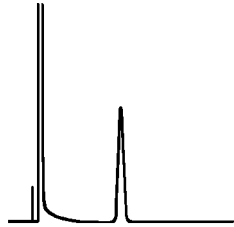
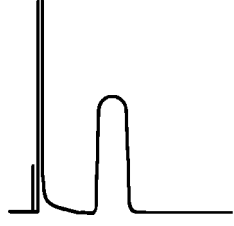
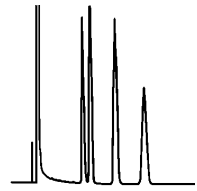
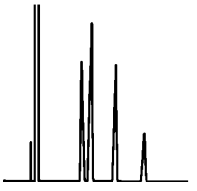
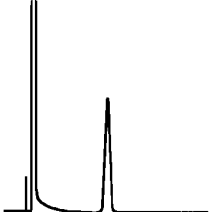
Symptom	Possible Cause	Remedy
Symptom No. 13: Extra Peaks (peaks similar to previous sample appear when solvent alone is injected)		
 <p>Previous Sample</p>  <p>Normal (solvent injected after sample)</p>  <p>Problem (solvent injected after sample)</p> <p style="text-align: right; font-size: small;">795-0336</p>	<ol style="list-style-type: none"> 1. Dirty syringe. 2. Column adsorbing, then desorbing sample (particularly in temperature program). 3. Adsorption in transfer line. 	<ol style="list-style-type: none"> 1. Try new syringe and clean solvent. If extra peaks disappear, clean syringes more thoroughly. 2. Use more inert column materials (tubing, packing, glass wool). 3. Use glass-lined stainless steel for transfer lines.
Symptom No. 14: Extra Peaks (unlike peaks in previous sample)		
 <p>Normal</p>  <p>Problem</p>  <p>Problem</p>	<ol style="list-style-type: none"> 1. Septum bleed, particularly in temperature program. 2. Peaks from previous runs, particularly if very broad with short retention time. 3. Impurities from sample, solvent, sample container (e.g., plasticizer from cap liners or contaminated glassware), labware, or reagents used in sample preparation, particularly when excess reagents are concentrated in work-up. 4. Condensed carrier gas impurities eluting during temperature programming. 5. Trace impurities in lab atmosphere. 6. Air peaks or water peaks. 7. Multiple or incomplete derivatives formed in sample work-up. 8. Sample decomposition. 	<ol style="list-style-type: none"> 1. Turn off injector heater. If extra peaks disappear, operate at lower injector temperature or use high temperature septa. 2. Let analysis run longer, then repeat. 3. Run solvent blank with clean syringe. If extra peaks appear, change solvent; if no extra peaks appear, run solvent blank through entire sample work-up. If no extra peaks appear, impurities are from sample. If extra peaks appear, repeat analysis of solvent blank for each step of work-up to isolate source. 4. Install or replace carrier gas purifier(s). 5. Analyze lab environment, take corrective action as necessary. 6. Normal with TCD, using syringe injection or aqueous samples. 7. Re-evaluate derivatization procedure. 8. Reduce temperature and/or use different column.

Symptom	Possible Cause	Remedy
Symptom No. 15: Tailing Peaks		
 <p>Normal</p>  <p>Problem</p> <p style="text-align: right;">795-0339</p>	<ol style="list-style-type: none"> 1. Column or injection port temperature too low. 2. Column deteriorating. 3. Active sample adsorbing on injection port, transfer lines, column, or glass wool. 4. Two compounds co-eluting. 5. Needle hitting packing in column inlet (breaks particles and creates active sites). 	<ol style="list-style-type: none"> 1. Increase temperature (do not exceed maximum temperature for column). 2. If retention times have not changed from when column was new, replacing first 6" of packing or replacing pre-column may help. If retention times have changed, replace column. 3. Use more inert system: all glass, Teflon[®], specially designed packing, on-column injection, proper glass wool type, etc. 4. Increase sensitivity, reduce sample size, reduce temperature approximately 20°C, look for partial separation. 5. Remove several cm of packing from inlet.
Symptom No. 16: Leading Peaks		
 <p>Normal</p>  <p>Problem</p> <p style="text-align: right;">795-0340</p>	<ol style="list-style-type: none"> 1. Column overload. 2. Two components co-eluting. 3. Sample condensation. 4. Sample decomposition. 	<ol style="list-style-type: none"> 1. Decrease sample size or select another column with higher stationary phase loading. Alternatively, select a different stationary phase with greater solubility for the component exhibiting this behavior. 2. Increase sensitivity, reduce sample size, reduce temperature approximately 20°C, look for partial separation. 3. Check injection port and column temperatures, increase if necessary. 4. Use inert system and deactivated packing.

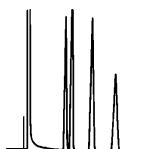
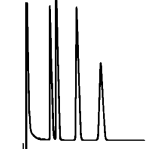
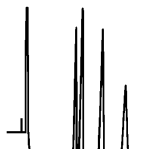

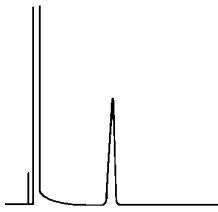

Symptom	Possible Cause	Remedy
Symptom No. 17: Split Peaks		
 <p data-bbox="235 436 316 462">Normal</p> <p data-bbox="235 730 324 756">Problem</p> <p data-bbox="495 760 560 781">795-0341</p>	<ol data-bbox="600 210 974 294" style="list-style-type: none"> 1. Gross detector overload. 2. Sample flashing prior to injection – simulates two injections. 	<ol data-bbox="1071 210 1477 346" style="list-style-type: none"> 1. Reduce sample size. 2. Use solvent flush technique, so sample is contained in barrel, not in needle (see pages 3 and 4). Use less volatile solvent.
Symptom No. 18: Squared (Flat-Topped) Peaks		
 <p data-bbox="235 1096 316 1121">Normal</p> <p data-bbox="235 1360 324 1386">Problem</p> <p data-bbox="503 1390 568 1411">795-0342</p>	<ol data-bbox="600 846 974 924" style="list-style-type: none"> 1. Electrometer saturated (normal for solvent). 2. Recorder defective. 	<ol data-bbox="1071 846 1461 924" style="list-style-type: none"> 1. Reduce sample size. 2. Troubleshoot per instruction manual.
Symptom No. 19: Round-Topped Peaks		
 <p data-bbox="235 1663 316 1688">Normal</p> <p data-bbox="235 1864 324 1890">Problem</p> <p data-bbox="495 1900 560 1921">795-0343</p>	<ol data-bbox="600 1470 876 1533" style="list-style-type: none"> 1. FID: detector overload. 2. Recorder gain too low. 	<ol data-bbox="1071 1470 1331 1533" style="list-style-type: none"> 1. Decrease sample size. 2. Adjust control.

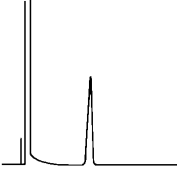
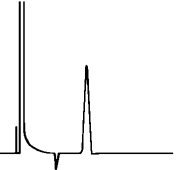
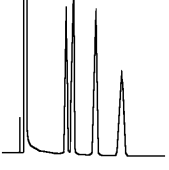
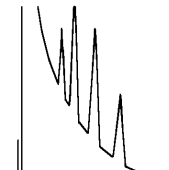
Symptom	Possible Cause	Remedy
Symptom No. 20: Cigar-Top Peaks		
 <p>Normal</p>  <p>Problem 795-0344</p>	<p>ECD: detector overload.</p>	<p>Reduce sample size.</p>
Symptom No. 21: Clipped Peaks – Column Efficiency Exceptionally High		
 <p>Normal</p>  <p>Problem 795-0345</p>	<p>Recorder or instrument zero below minimum moveable range of recorder pen.</p>	<p>Shunt recorder leads and set recorder baseline adjustment zero to approximately 5% of full scale.</p>
Symptom No. 22: Baseline Rise Before or After Peak		
 <p>Normal</p>  <p>Problem Problem</p> <p style="text-align: right;">795-0346</p>	<p>Sample decomposition.</p>	<p>Use inert column and packing.</p>

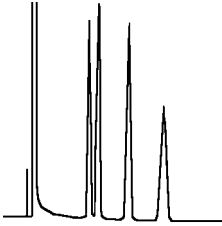
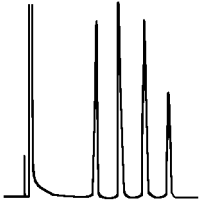
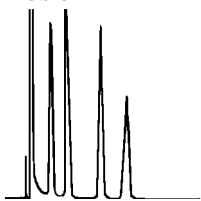
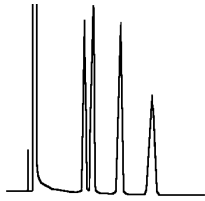
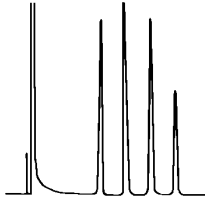
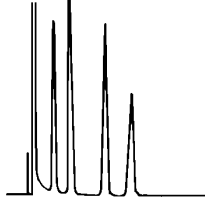
Symptom	Possible Cause	Remedy
Symptom No. 23: Baseline Change After Large Peak		
 <p>Normal</p>  <p>Problem</p>  <p>Problem</p> <p style="text-align: right;">795-0347</p>	<ol style="list-style-type: none"> 1. Contamination – water or large component stripping contaminants from column. 2. Column not conditioned properly – liquid phase being stripped. 3. Pressure imbalance when gas sampling valve activated. 	<ol style="list-style-type: none"> 1. Repack first 6" of column or replace pre-column. 2. Recondition column. 3. Correct pressure imbalance.
Symptom No. 24: Baseline Drop After Peak (FID only – flame extinguished)		
 <p>Normal</p>  <p>Problem</p> <p style="text-align: right;">795-0348</p>	<ol style="list-style-type: none"> 1. Sample too large. 2. Incorrect gas flows. 3. Flame tip plugged. 4. Collector and flame tip not located properly (whistling or humming noise often heard). 	<ol style="list-style-type: none"> 1. Decrease sample size. 2. Check and adjust carrier gas, hydrogen, and air. 3. Clean or replace flame tip. 4. Adjust collector position.

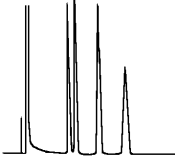
Symptom	Possible Cause	Remedy
Symptom No. 25: Negative Dips After Peaks		
 <p>Normal</p>  <p>Problem</p> <p style="text-align: right;">795-0349</p>	<ol style="list-style-type: none"> 1. Only after large peak such as solvent: sample too large. 2. After all peaks with ECD: dirty detector cell. 	<ol style="list-style-type: none"> 1. Decrease sample size. 2. Clean detector.
Symptom No. 26: Negative Dip Before Peak		
 <p>Normal</p>  <p>Problem</p> <p style="text-align: right;">G0001158</p>	<p>Pressure imbalance when gas sampling valve activated.</p>	<p>Correct pressure imbalance.</p>
Symptom No. 27: Broad Solvent Peaks		
 <p>Normal</p>  <p>Problem</p> <p style="text-align: right;">795-0350</p>	<ol style="list-style-type: none"> 1. Dead volume in injection port due to poor column installation. 2. Normal with very dilute sample, as in trace analysis. 3. Poor injection technique. 4. Injection port temperature too low. 5. Sample solvent interacts with detector. 6. Sample solvent retained by column (e.g., methanol by active column). 	<ol style="list-style-type: none"> 1. Use on-column injection. Ensure proper column connections, particularly when changing from one column diameter to another. 2. — 3. Make smooth, rapid injections (see page 3). 4. Increase injection port temperature. 5. Change sample solvent. 6. Change sample solvent.

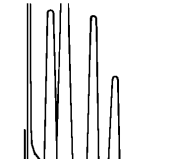
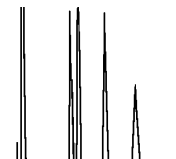
Symptom	Possible Cause	Remedy
Symptom No. 28: Retention Time Longer / Shorter		
<p>On Same Column</p>  <p>Normal</p>  <p>Problem</p>  <p>Problem</p> <p style="text-align: right;">795-0351</p>	<ol style="list-style-type: none"> 1. Column temperature too high/too low. 2. Carrier gas flow rate too low/too high. 3. Septum or column leak. 4. Column contamination or deterioration. 5. Recorder problem. 6. Sample overload. 	<ol style="list-style-type: none"> 1. Check temperature with independent thermometer, adjust as necessary. 2. Measure rate with soap bubble flow meter at column exit, adjust as necessary. 3. Check, correct as necessary. 4. Repack first 6" of column, or replace column. 5. Check recorder chart speed. 6. Reduce sample size.
<p>On New Column (compared to previous column of same composition)</p>  <p>Normal</p>  <p>Problem</p>  <p>Problem</p> <p style="text-align: right;">795-0352</p>	<ol style="list-style-type: none"> 1. Column too long/too short. 2. More/less packing in column due to: <ol style="list-style-type: none"> a. Support density greater/less than previously used. b. Column packed more tightly/loosely. c. Column inside diameter greater/smaller. 3. Too much/too little stationary phase on support, due to different manufacturing procedures or to errors. 4. Stationary phase different, or variation in phase composition (particularly common with commercial chemicals not manufactured for GC). 5. Support type different. 	<p>Use tested, standardized columns and packings.</p>

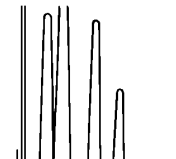
Symptom	Possible Cause	Remedy
Symptom No. 29: Unresolved Peaks		
<p>On Column Which Previously Produced Good Results</p>  <p>Normal</p> <p style="text-align: right;">795-0356</p>  <p>Problem</p>  <p>Problem</p> <p style="text-align: right;">795-0354</p>	<ol style="list-style-type: none"> 1. Wrong column temperature. 2. Wrong carrier gas flow rate. 3. Sample problem: <ol style="list-style-type: none"> a. Sample too large. b. Sample concentration different from previous analysis – minor peak “swamped” by major peak. 4. Poor injection technique (slow). 5. Column contaminated or deteriorated. 	<ol style="list-style-type: none"> 1. Check and adjust temperature. 2. Check and adjust flow rate. 3. <ol style="list-style-type: none"> a. Reduce sample size. b. Reduce sample size. 4. Make smooth, rapid injections. 5. Repack first 6” of column, or replace column.
<p>After Previous Column of Same Composition Produced Good Results</p>  <p>Normal</p>  <p>Problem</p>  <p>Problem</p> <p style="text-align: right;">795-0355</p>	<ol style="list-style-type: none"> 1. Column too long/too short. 2. More/less packing in column due to: <ol style="list-style-type: none"> a. Support density greater/less than previously used. b. Column packed more tightly/loosely. c. Column inside diameter greater/smaller. 3. Too much/too little stationary phase on support, due to different manufacturing procedures or to errors. 4. stationary phase different, or variation in phase composition (particularly common with commercial chemicals not manufactured for GC). 5. Support type different. 	<p>Use tested, standardized columns and packings.</p>

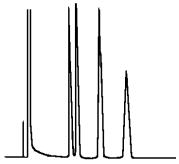
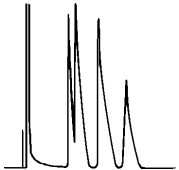
Symptom	Possible Cause	Remedy
Symptom No. 30: Large Gaps Appear In Packing (visible in a glass column)		
	Column improperly packed.	Add enough packing to fill voids, then gently vibrate until smooth. If this does not solve problem, repack column.
Symptom No. 31: Packing Compacts or Shirks After Conditioning		
	<ol style="list-style-type: none"> Slight compacting may occur when packings are exposed to pressure. Significant compacting (bed contracts 3" or more). 	<ol style="list-style-type: none"> Normally not a problem – use column. Column may not be properly packed. Add more packing.
Symptom No. 32: Low Carrier Gas Flow/Large Pressure Drop		
	<ol style="list-style-type: none"> Overtightened septum. Insufficient carrier gas source pressure. Insufficient source pressure for temperature program. Plugged injection port, carrier gas line, or gas purifier(s). Column over-packed or glass wool too tight. 	<ol style="list-style-type: none"> Loosen septum. Increase pressure by 10psig. Flow control must have 10-15psig higher than maximum pressure (reached at maximum temperature) to function properly. Replace tubing or gas purifier(s) as necessary. Increase carrier gas pressure. If flow still insufficient, install another column. (Note: not all packings have same pressure drop.) If flow okay, original column was problem. If flow low, check plumbing system for flow restrictions (plugged detector, plugged gas filter, etc.).
Symptom No. 33: Column Deteriorates Too Soon After Installation (peaks tail, are poorly resolved, etc.)		
 <p>Normal</p>  <p>Problem</p>	<ol style="list-style-type: none"> Column operated near or above maximum temperature limit of packing. Water or oxygen in carrier gas contaminating column. Column leaks causing contamination by oxygen. Column damaged by aqueous samples, serum, plasma, other complex samples. These samples can (1) strip phase from support, (2) chemically react with phase, (3) build up on column and possibly destroy it, injection end first. 	<ol style="list-style-type: none"> Use higher temperature phase. Use shorter column and lower temperature, if possible. Reduce temperature when column not in use. Remove column from oven when another column is used at higher temperature. Use carrier gas purifier(s) and appropriate grades of gases. Replace tanks before pressure becomes too low (300psig). Check for leaks prior to use. Always allow column to cool before removing from GC, to prevent exposing a hot column to air. Use precolumns or repack column inlet to extend column life.

795-0356

Thermogreen™ LB-2 Septa

- Extremely low bleed from 100°C to 350°C
- Already conditioned, ready to use
- Easier needle penetration, high puncture tolerance

Disc Diameter		Qty.	Cat. No.
mm	Inch		
5.0	3/16	50	20638
6.0	1/4	50	20651
9.5 ¹	3/8	50	20652
9.5 ¹	3/8	250	20666
9.5 ¹	3/8	1000	20677
10.0	13/32	1000	23157
11.0	7/16	50	20654
11.0	7/16	250	23163
11.0	7/16	1000	23164
11.5	11/24	50	23154
12.5	1/2	50	20660-U
12.5	1/2	250	20678
14.0	9/16	50	20662-U
16.0	5/8	50	20663
17.0	21/32	50	23159

Cylindrical, for Shimadzu® instruments

Plug Type	10	20608
Plug Type	50	20633

Drilled, for Solid Phase Microextraction

9.5 ¹	3/8	25	23161
9.5 ¹	3/8	50	23162-U
11.0	7/16	25	23167
11.0	7/16	50	23168

¹ We recommend a 9.5mm (3/8") septum to those who previously used the 9mm size.

Thermogreen LB-1 Septa

- Inlet temperature: 50°C to 300°C

Disc Diameter		Qty.	Cat. No.
mm	Inch		
9.5	3/8	50	20659-U
10.0	13/32	50	20657-U
11.0	7/16	50	20658
12.5	1/2	50	20661

Cylindrical, approx. 6mm diameter x 9mm

Thru-Hole Type	100	20667
Half-Hole Type	100	20668

Pyrosep™ S-1 Septa

Inlet Temperature: 300°C to 400°C. Because they are relatively hard, Pyrosep S-1 septa must be used with a needle guide (to prevent the needle from buckling) and only at high temperatures.

Disc Diameter		Qty.	Cat. No.
mm	Inch		
6	1/4	10	22369
9.5	3/8	10	22370-U

Adapter Rings (pk. of 2)

9.5mm OD x 6mm ID ¹	22338
11mm OD x 9.5mm ID ²	22607
12.5mm OD x 9.5mm ID ³	22340-U

¹ Use with 6mm septa, to replace 9.5mm septa.

² Use with 9.5mm septa, to replace 11mm septa.

³ Use with 9.5mm septa, to replace 12.5mm septa.

Septum Nuts



P00261

The needle guide in Supelco septum nuts ensures that the needle consistently penetrates the septum in the same place, prolonging septum life. The guide also prevents the needle from striking the edge of the column or bending during insertion. The 9/16" hexagonal nut head accommodates our torque wrench for consistent, optimum tightening. Each nut is supplied with easily interchanged 1/2" and 1" guides. Use 9.5mm septa with each nut.

The stainless steel nuts hold up under heavy use (e.g., when septa are replaced daily). We also recommend using them for reactive samples, such as chlorinated pesticides. Aluminum nuts offer economy in light use or when samples are nonreactive (i.e., when metal columns are used).

Nut N-1 fits PE-3920, 900, Sigma series, HP-5700, other ports accepting 1/4" Swagelok nut, 7/16" threads, 20/inch.

Nut N-2 fits Varian 3700, other ports accepting 1/4" nut, 7/16" threads, 24/inch.

Use with packed columns only.

Description	Cat. No.
Septum Nut N-1	
Stainless Steel ¹	22399
All Aluminum	22497
Septum Nut N-2	
All Aluminum	22402

¹ Aluminum needle guide.

Torque Wrench

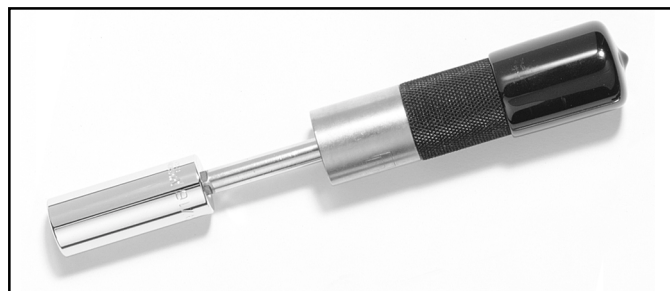

9130363

The handle of the Supelco septum nut torque wrench slips when preset torque (8 inch-lbs.) is reached. Helps prevent leaking septa, excess bleed, and difficult septum penetration. Deepwell socket (9/16") fits over the Supelco septum nut even with a needle guide attached.

Description	Cat. No.
Torque Wrench	22661

Select the best ferrule for your application:

Supeltex™ ferrules form leaktight seals without sticking to your column. And they don't require back ferrules.

We highly recommend:

- Supeltex M-4 and Supeltex M-2A ferrules for glass columns
- Supeltex M-2A and Supeltex M-2 ferrules for metal columns

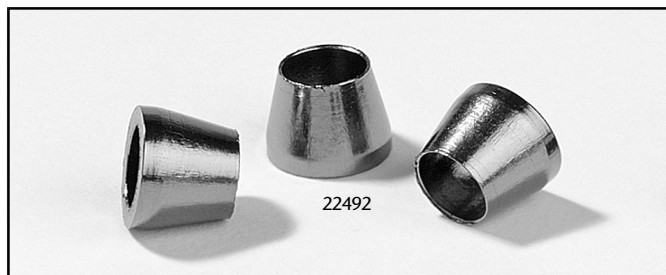

P000182

Ferrule	Max. Temp.	Characteristics
Supeltex M-1 ceramic-filled Teflon	250°C	Ideal for connections to mass spectrometers. High reusability Isothermal use only
Supeltex M-2 du Pont VESPEL® SP-1 (100% polyimide)	350°C	High reusability
Supeltex M-2A du Pont VESPEL SP-21 (85% polyimide/15% graphite)	400°C	Seals at 1/4 turn past fingertight. High reusability Won't stick to metal or glass.
Supeltex M-2B du Pont VESPEL SP-211 (10% Teflon graphite/75% polyimide)	350°C	Conforms easily to capillary column, ensuring an effective seal and less chance of breakage.
Supeltex M-4 flexible graphitere	450°C	Seals at 1/4 turn past fingertight. Maximum sealing surface contact, reduced risk of column contamination at installation.
O-Ring silicone	200°C	Seals column having OD over or under specifications.

Supeltex Ferrules for Packed Columns

Supeltex Ferrule Type (Temp. Limit)	Column OD				Qty.
	1/4"	6mm	1/8"	1/16"	
M-1 (250°C)	22086-U	22089	22496	22386	10
	22087-U	–	22309	–	100
M-2 (350°C)	22320-U	–	22321	20644-U	10
	22475	–	22476	–	50
M-2A (400°C)	22481	22393	22483-U	22487-U	10
	22471	–	22472	–	50
Indented Blank ¹	–	–	–	22488	10
M-4 (450°C)	22492	22493	22491	22495	10
	22478	–	–	–	50
O-Rings (200°C)	20407	–	20406	–	100
Ferrule ID:	1/4"	6mm	1/8"	1/16"	

¹Drill to fit your column.

Leak Tester Kit

Eliminates placing leak detection fluid, a potential contaminant, directly onto the septum. Dip one end of the leak tester tube into Snoop and place the other end into the septum nut or needle guide. Bubbles indicate a leak. Kit includes 10 leak tester tubes and 8 ounces of Snoop.

Leak-Tec® Leak Detector

Use at temperatures up to 210°C – Leak-Tec leak detector will not bubble on a heated part unless there is a leak. 283g pressurized can.

Description	Cat. No.
Leak Tester Kit	22660-U
Snoop, 8oz. bottle	20434
Leak-Tec Leak Detector, 283g	20566

Glasrench Wrench



9130289

Our Glasrench lets you consistently apply just the correct force needed to tighten the ferrule – the wrench slips when too much force is applied. You know when to stop tightening and you don't damage your column. Because different ferrules require different amounts of tightening force, we offer two color-coded models. 9/16", for 1/4" fittings.

Description	Cat. No.
Glasrench	
Model A (for Supeltex M-1, Supeltex M-2 ferrules)	22901
Model C (for Supeltex M-2A, Supeltex M-4 ferrules)	22903







Trademarks

Bransonic – Branson Cleaning Equipment Co.
 CapSeal Bullet, Glasrench, OMI, PureCol, Pyrosep, Supelco, Supeltex,
 Thermogreen – Sigma-Aldrich Co.
 Freon, VESPEL – E.I. du Pont de Nemours & Co., Inc.
 GOW-MAC – GOW-MAC Instrument Co.
 Hamilton – Hamilton Co.
 Hewlett-Packard – Hewlett-Packard Corp.
 Leak-Tec – American Gas & Chemical Co., Ltd.
 Perkin-Elmer – Perkin-Elmer Corp.
 Shimadzu – Shimadzu Corp.
 Snoop – Nupro Co.
 Swagelok – Crawford Fitting Co.

Deactivated Glass Liners for Packed Column Injection Ports

We can prepare liners to your specifications. Just call our Ordering and Customer Service Departments for a quote.

These deactivated glass liners prevent reaction between active sample components and the injection port's metal surfaces.

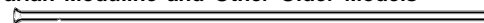
Instrument Manufacturer & Model	Liner Description	Mfr. Part No.	Qty.	Cat. No.
Hewlett-Packard® 5700, 5830/40A, 5880A, 5890A				
	Glass liner	5080-8732	5	20508
91.5mm x 3mm OD	1.8mm ID		25	20511
Perkin-Elmer® 3920				
	Glass liner	0009-1958	1	26302
143mm x 4.6mm OD	2.75mm ID			
	Glass liner (small bore)	0009-1614	1	26301
	1.5mm ID			
Perkin-Elmer 8000, Sigma 2000/2100, Sigma 1B-4B & 300 manufactured 1978 or later				
	Glass liner	0330-2221	1	26300-U
	2.75mm ID		5	26409
	Glass liner (small bore)	0330-2243	25	26464
	1.5mm ID		1	26305
101mm x 4.6mm OD, 1.5mm ID				
Perkin-Elmer Auto System, Model 9000				
Unpacked				
	Packed column	N610-1048	1	26316,01
	3mm ID		5	26316,05
112mm x 6mm OD			25	26316,25
Packed (deactivated glass wool)				
	For dirty samples		1	26317,01
	3mm ID		5	26317,05
112mm x 6mm OD			25	26317,25
Shimadzu				
	Wool packed			
104mm x 4.5mm OD	3mm ID	221-14755	1	26332
Varian Universal Flash Injectors 1060-60, 3300, 3400, 3500-3600, older 3700/VISTA				
	Glass injector insert	37-000813-00	1	26369
	(wool packed)		5	26426
72mm x 6.3mm OD			25	26481
Varian Moduline and Other Older Models				
	Glass insert	6-000107-01	10	26370-U
5½"/14cm x 1/8" ID	1.8mm ID			

G000405-412

PureCol™ Column Inlet Liners



713-0449

When nonvolatiles accumulate in the column inlet, you must replace several inches of packing – or the entire column. A silanized glass PureCol liner, inserted in the column inlet, solves this problem simply and inexpensively. When column performance begins to deteriorate, you can quickly and conveniently replace the insert – often without removing the column from the instrument. Replacement time is comparable to replacing a septum. Replace the PureCol liner when you change the septum, or when you analyze a new type of sample.

PureCol liners are available in two sizes. The smaller size fits 2mm ID glass columns with chamfered ends and 7cm of straight, unpacked inlet. The larger size fits any 4mm ID glass column that has 7cm of straight, unpacked inlet. Use PureCol liners with a 2" (5cm) 21-gauge or finer needle.

Description	Qty.	Cat. No.
For 2mm ID Columns (chamfered inlet only)		
	10	20534
	50	20536
For 4mm ID Columns		
	10	20540-U
	50	20543

Order your glass column with a PureCol liner already in place – at no extra cost. Just specify "glass column with PureCol liner" on your order.

Humonics Veri-Flow 500 Electronic Flowmeter

- Calibrated for nitrogen, helium, hydrogen, air, 5% argon/ methane (certificate supplied)
- Range of 5-500mL/min; accurate to within $\pm 2\%$ of reading or 0.25mL (whichever value is larger)
- Continuous readings in volume, linear velocity, or split ratio
- EPC compatible
- 9-pin RS 232 communication port for recording data
- Power adapter jack and recharger
- Only 4 x 5 x 3" (10 x 12.5 x 7.5cm)

An outstanding instrument for analysts who want a simple, continuous-reading flowmeter for general GC applications.

The Veri-Flow 500 Electronic Flowmeter is multiple-point calibrated to NIST-certified volumetric standards, for superior accuracy and to help you comply with ISO 9000, GLP, and other stringent quality control protocols. Operation is pulse-free, unaffected by temperature or pressure changes, and the unit is fully compatible with electronic pressure control systems. Operates on internal rechargeable batteries. Very low power consumption and automatic shut-off.



P000218

Description	Cat. No.
Veri-Flow 500 Electronic Flowmeter¹	
110VAC	23143
with universal charger, 110-240VAC, 50/60Hz ²	23142

¹ CE approved

² Includes 110VAC USA, 220VAC European power cords

Humonics Model 1000 Liquid Flowmeter

- Easy set-up and operation
- NIST traceable

Humonics digital liquid flowmeters replace the tedious and time-consuming glass burette and stopwatch traditionally used to measure flow rates – a microcomputer and infrared optics are used to track a rising volume of liquid within a tube of precision-bore glass. Absolute accuracy is established by comparing the performance of the instrument to an NIST-registered burette.



P000222

Model	Flow Range (mL/min)	Resolution	Calibration Points
1010	0.100 - 1.999 2.00 - 6.00	0.001 0.01	0.5, 1.5, 5 mL/m in
1000	0.100 - 1.999 2.00 - 9.99 10.0 - 30.0	0.001 0.01 0.1	1.5, 3, 5 mL/min

Humonics Optiflow Flowmeters

- Four flow ranges available; accurate to within ± 2 or $\pm 3\%$ of any reading
- Portable – includes standard 9-volt battery
- Patented U-tube design for lighter-than-air gases
- Fault condition display
- Automatic power-off for extended battery life
- Low battery indicator
- Field replaceable tubes
- Compatible with electronic pressure control
- Computer interface capability on Model 650



P000221

These high-precision instruments combine the simplicity and versatility of a bubble meter with the speed and accuracy of a microprocessor, providing you with a reliable means of measuring gas flow.

The versatile units can be used with *all* gases. And they feature an easy-to-read, accurate digital display, eliminating the need for tedious bubble watching, timing, and flow rate/time conversions. The bubble is visible for your observation.

Optiflow Digital Flowmeters help you comply with the quality protocols of the American Society for Quality Control, ISO 9000, and Good Laboratory Practice. Each unit is individually calibrated to the registered standards of the National Institute of Standards and Technology and comes with a certificate of calibration. A recalibration service is available.

Optiflow 420 Digital Flowmeter
Flow Range: 0.5-50mL/min
Accuracy: $\pm 3\%$ of any reading
Display: mL/min or linear velocity

Optiflow 520 Digital Flowmeter
Flow Range: 0.5-500mL/min
Accuracy: $\pm 3\%$ of any reading
Display: mL/min or split ratio

Optiflow 570 Digital Flowmeter
Flow Range: 0.5-700mL/min
Accuracy: $\pm 2\%$ of any reading
Display: mL/min or split ratio

Optiflow 650 Digital Flowmeter
Flow Range: 5-5000mL/min
Accuracy: $\pm 2\%$ of any reading
Display: mL/min or split ratio

Description	Cat. No.
Model 1010 Liquid Flowmeter 110VAC	56692-U
Model 1010 Liquid Flowmeter 220VAC	56693-U
Model 1000 Liquid Flowmeter 110VAC	55090-U
Optiflow 420 Digital Flow Meter	22806
Replacement Flow Tube	22779-U
Optiflow 520 Digital Flow Meter	22910
Replacement Flow Tube	22776
Optiflow 570 Digital Flow Meter	22741-U
Replacement Flow Tube	22777
Optiflow 650 Digital Flow Meter	22912
Replacement Flow Tube	22778

GOW-MAC® Gas Leak Detectors

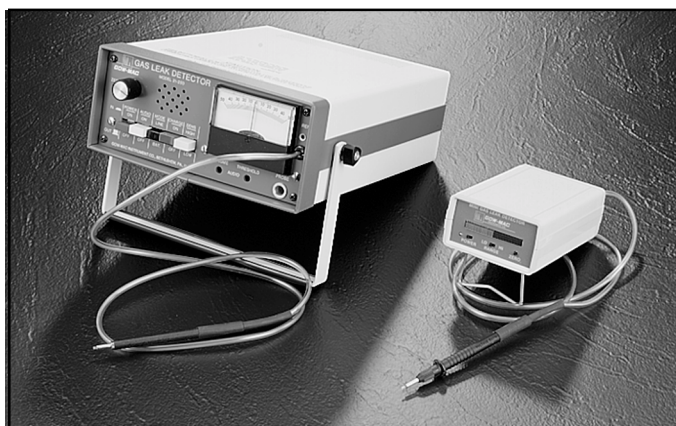

P000330

Using liquids to detect gas leaks can be poor economy, especially in a capillary GC system. Even a small amount of liquid leak detector that seeps into a fitting, or through the septum, can damage your column or create baseline noise. GOW-MAC gas leak detectors easily and quickly pinpoint gas leaks too small to detect with soap solution.

GOW-MAC gas leak detectors operate on the same principle as a thermal conductivity detector – they respond to any gas mixture that has a thermal conductivity value different from that of air. With an intrinsically high signal-to-noise ratio, amplification provides maximum usable sensitivity: helium leaks of 1.0×10^{-5} cc/sec and refrigerant leaks of 1.0×10^{-4} cc/sec are easily detected.

Both models have a 1-year warranty from GOW-MAC.

Specifications: Deluxe Detector

Output: Audio. Frequency changes with concentration; adjustable threshold and speaker volume.

Range: High: x1; Low: x100

Dimensions: 10 3/4 x 8 1/4 x 3 5/8" (27 x 21 x 9cm) (excluding handle)

Weight: 9lb/4.1kg (shipping wt.: 12lb/5.4kg)

Power: Rechargeable lead/acid gel battery, 8V, selectable 115/230VAC, 50/60 Hz

Specifications: Miniature Detector

Output: Visual LED bar graph alerts you to leaks

Range: High: x1; Low: x100

Dimensions: 3 1/4 x 1 13/16 x 5 1/4" (8 x 4.5 x 13cm)

Weight: >1lb/474g, without charger

Line Voltage: Rechargeable Ni-Cd battery, 7.2V/800mA/hr; recharger included: 115VAC/60Hz or 230VAC/50Hz

Description	Cat. No.
GOW-MAC Gas Leak Detectors	
Deluxe Model 21-250 ¹	22409
Mini Detector: Model 21-050	
with 115VAC/60Hz recharger	22807
with 230VAC/50Hz recharger ²	22808
Carrying Case for Mini Detector	22809

¹Does not have a CE mark.

²CE approved.

NOTE: These GOW-MAC gas leak detectors are not intended for determining leaks of combustible gases. They are intended for nonspecific applications, to determine low level leaks of gases with thermal conductivity different from that of air. We recommend a combustible gas detector for monitoring combustible gases in possibly hazardous situations.

Branson® Ultrasonic Cleaner

Ultrasonic cleaning is fast, effective, and safe, and this Branson cleaner has more ultrasonic power than most comparable models. Ensures faster, more thorough cleaning of dirt, protein residue, etc. from your glassware, fittings, syringes and needles, and other apparatus.

Recessed cleaning tank is enclosed in durable, solvent and impact resistant plastic, for longer life.

Tank Size:

5 1/2" x 6" x 4" deep (14 x 15 x 10cm);

1/2 gallon/1.8 liter capacity

Overall Size:

7 1/2" x 8 1/2" x 9" (19 x 22 x 23cm)

Weight:

7 lbs. (3.2kg)

Immersion Cleaner

An aqueous and nontoxic surfactant solution that removes heavy deposits of silica from a detector. Recommended for dirty detectors not effectively cleaned by our in-place detector cleaner (Cat. No. 33000-U). Mix concentrate 1:10 with water.

In-Place Detector Cleaner

A halocarbon liquid that cleans the detector in place. Just inject microliter quantities into a packed column while it is connected to a lighted flame detector. HF, produced by combustion of the cleaner, removes silica deposits from detector electrodes. Also useful for removing greases and oils from glassware, syringes, etc. 100mL bottle.

Jet and Needle Cleaning Kit

Ten wires in each of five sizes (0.00350, 0.00497, 0.00659, 0.00815, and 0.01207" OD), plus a bottle of syringe cleaning solution. Perfect for cleaning small orifices such as FID jets and syringe needles.

Packaged in a reusable box that prevents wires from being damaged during storage.

Wire Brush Detector Cleaning Kit

A collection of wire brushes specially tailored to clean FIDs and injection ports that accept 1/4" columns. Brass brushes prevent scratching and marring of expensive FID components and save downtime by allowing the detector to be cleaned while hot.

Each kit includes two detector brushes, one injection port tube brush, a brass toothbrush (for cleaning jets and other odd surfaces), and a piece of fine emery cloth to clean electrical contacts.

Just measure your collector assembly ID and choose the closest kit. Instructions are included.

Description	Cat. No.
Branson Ultrasonic Cleaner¹	
110VAC	22326
220VAC	22336
Cleaning Solution, 1 quart (0.9 liter)	22335
Immersion Cleaner, 100mL	22662
In-Place Detector Cleaner	33000-U
Jet and Needle Cleaning Kit	21578
Wire Brush Detector Cleaning Kit	
Collector Assembly ID	
0.145" (e.g., HP 5700, 5830)	22403
0.187" (e.g., Perkin-Elmer Sigma Series 3900, 900)	22405
0.235" (e.g., Varian 3700, 1400, 2700)	22404

¹ CE approved.

High Capacity Gas Purifier

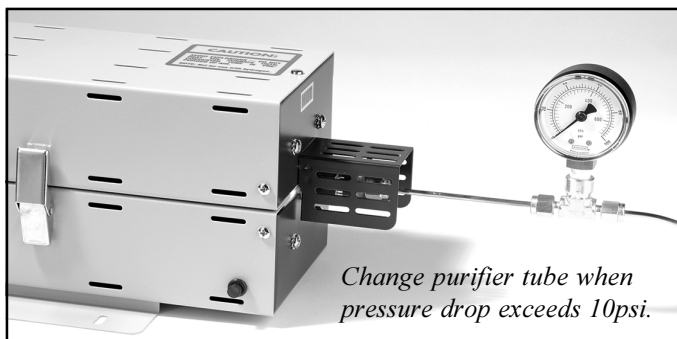

Change purifier tube when pressure drop exceeds 10psi.

P000356

To reliably protect your GC columns and detectors from oxygen and water vapor damage, you should use a gas purifier specifically designed to ensure maximum gas purity. The Supelco High Capacity Gas Purifier tube is heated inside an oven, and oxygen and water react with the gettering material in the tube. Chemical reaction with the gettering material prevents these contaminants from returning to the gas stream. The High Capacity Gas Purifier also removes carbon monoxide and carbon dioxide.

A single, replaceable High Capacity Gas Purifier tube can remove 14 liters of oxygen or 35 liters of water vapor (STP). It removes oxygen and water from at least 60 tanks of heavily contaminated gas — gas containing 100ppm of oxygen and/or water. It efficiently removes oxygen and water at gas flow rates up to 1100mL/minute, and you can use it with any common carrier gas except hydrogen.

The stainless steel converter tube is 10" x 1/2" OD. The split-sided heater is 10" long. An integral mounting bracket allows you to bolt the unit to a bench top or wall. The 90 watt power consumption makes the unit as economical to operate as a light bulb.

1-year guarantee; elements guaranteed for 90 days.

Description	Cat. No.
High Capacity Gas Purifier	
110VAC, 1/8" Fittings ¹	23800-U
110VAC, 1/4" Fittings ¹	23802
220VAC, 1/8" Fittings ¹	23801
220VAC, 1/4" Fittings ¹	23803
Replacement Purifier Tubes	
1/8" Fittings	22396
1/4" Fittings	22398

¹CE approved.

Pressure Gauge Kit

Use to indicate when the high capacity gaspurifier tube should be replaced. 2"/5cm gauge (0-100psi), NPT to Swagelok adapter, 18"/1/2m of 1/8" copper line, 1/8" tee, installation instructions.

Description	Cat. No.
Pressure Gauge Kit	20392

OMI Indicating Purifiers

- Simultaneously remove O₂, water vapor, CO, CO₂, most sulfur compounds, most halogen compounds, alcohols, phenols to less than 10ppb
- Purify helium, hydrogen, nitrogen, argon-methane
- Color change indicates purifier exhaustion
- Glass body does not diffuse air or off-gas
- Ideal for Hall, ECD, GC/MS detection systems
- OMI-4 purifier protects multiple instruments (three times the capacity of OMI-2 tubes)



P000245

Install an OMI purifier downstream from your primary gas purifying device, and tell at a glance whether or not oxygen and water vapor are being effectively eliminated from your system. The OMI purifier will provide point-of-use gas polishing and final visual assurance of gas quality before the gas enters the GC. OMI purifier tubes contain Nanochem resin, developed for the demanding gas purity needs of the semiconductor manufacturing industry. As little as 1ppm of oxygen or water will change the indicating resin from black to brown.

Dimensions of OMI Purifiers

OMI-2

Tube: 6"/15.2cm x 5/8"/1.6cm OD
 Tube Holder: 10"/25.4cm x 1 1/2"/3.8cm OD
 Endfittings: 2 1/2"/6.4cm

OMI-4

Tube: 12"/30.5cm x 1"/2.5cm OD
 Tube Holder: 16"/40.6cm x 1 1/2"/3.8cm OD
 Endfittings: 2 1/2"/6.4cm

Description	Cat. No.
OMI-2 Purifier Tube ¹	23906
OMI-2 Tube Holder, 1/8" fittings ¹	23921
Seal Kit for OMI-2 Tube Holder (includes 2 Teflon seals and tool)	23917
OMI-4 Purifier Tube ¹	23909
OMI-4 Tube Holder, 1/8" fittings ¹	23926
OMI-1 Replacement Tube ² (includes 2 ferrules)	23900-U
3/8" Ferrules (pk. of 10)	22311
1/4" to 1/8" Swagelok SS Reducer	21517

¹ First time users must order both purifier tube and corresponding holder. Holder is reusable.

² Will not fit OMI-2 tube holder – use with OMI-1 installation kit only (kit no longer available).

For more information, or current prices, contact your nearest Supelco subsidiary listed below. To obtain further contact information, visit our website (www.sigma-aldrich.com), see the Supelco catalog, or contact Supelco, Bellefonte, PA 16823-0048 USA.

ARGENTINA · Sigma-Aldrich de Argentina, S.A. · Buenos Aires 1119 AUSTRALIA · Sigma-Aldrich Pty. Ltd. · Castle Hill NSW 2154 AUSTRIA · Sigma-Aldrich Handels GmbH · A-1110 Wien
 BELGIUM · Sigma-Aldrich N.V./S.A. · B-2880 Bornem BRAZIL · Sigma-Aldrich Quimica Brasil Ltda. · 01239-010 São Paulo, SP CANADA · Sigma-Aldrich Canada, Ltd. · 2149 Winston Park Dr., Oakville, ON L6H 6J8
 CZECH REPUBLIC · Sigma-Aldrich s.r.o. · 186 00 Praha 8 DENMARK · Sigma-Aldrich Denmark A/S · DK-2665 Vallensbaek Strand FINLAND · Sigma-Aldrich Finland/YA-Kemia Oy · FIN-00700 Helsinki
 FRANCE · Sigma-Aldrich Chimie · 38297 Saint-Quentin-Fallavier Cedex GERMANY · Sigma-Aldrich Chemie GmbH · D-82041 Deisenhofen GREECE · Sigma-Aldrich (o.m.) Ltd. · Ilioupoli 16346, Athens
 HUNGARY · Sigma-Aldrich Kft. · H-1067 Budapest INDIA · Sigma-Aldrich Co. · Bangalore 560 048 IRELAND · Sigma-Aldrich Ireland Ltd. · Dublin 24 ISRAEL · Sigma Israel Chemicals Ltd. · Rehovot 76100
 ITALY · Sigma-Aldrich s.r.l. · 20151 Milano JAPAN · Sigma-Aldrich Japan K.K. · Chuo-ku, Tokyo 103 KOREA · Sigma-Aldrich Korea · Seoul MALAYSIA · Sigma-Aldrich (M) Sdn. Bhd. · 58200 Kuala Lumpur
 MEXICO · Sigma-Aldrich Quimica S.A. de C.V. · 50200 Toluca NETHERLANDS · Sigma-Aldrich Chemie BV · 3330 AA Zwijndrecht NORWAY · Sigma-Aldrich Norway · Torshov · N-0401 Oslo
 POLAND · Sigma-Aldrich Sp. z o.o. · 61-663 Poznań PORTUGAL · Sigma-Aldrich Quimica, S.A. · Sintra 2710 RUSSIA · Sigma-Aldrich Russia · Moscow 103062 SINGAPORE · Sigma-Aldrich Pte. Ltd.
 SOUTH AFRICA · Sigma-Aldrich (pty) Ltd. · Jet Park 1459 SPAIN · Sigma-Aldrich Quimica, S.A. · 28100 Alcobendas, Madrid SWEDEN · Sigma-Aldrich Sweden AB · 135 70 Stockholm
 SWITZERLAND · Supelco · CH-9471 Buchs UNITED KINGDOM · Sigma-Aldrich Company Ltd. · Poole, Dorset BH12 4QH
 UNITED STATES · Supelco · Supelco Park · Bellefonte, PA 16823-0048 · Phone 800-247-6628 or 814-359-3441 · Fax 800-447-3044 or 814-359-3044 · email: supelco@sial.com

Supelco is a member of the Sigma-Aldrich family. Supelco products are sold through Sigma-Aldrich, Inc. Sigma-Aldrich warrants that its products conform to the information contained in this and other Sigma-Aldrich publications. Purchaser must determine the suitability of the product for a particular use. Additional terms and conditions may apply. Please see the reverse side of the invoice or packing slip.

H

AIS