

Gas Management Systems for GC

The information in this bulletin, in combination with the instruction manual for your chromatograph, will help you to use your gas management resources wisely and obtain efficient performance from one, several, or many gas chromatographs. Preceding information and diagrams specific for installing gas delivery systems for 1, 2-4, or 5-20 gas chromatographs is information common to all installations: how to choose, clean, and connect tubing, the comparative merits of gas cylinders and gas generators, how to attain a suitable level of gas purity, etc. We recommend you read this bulletin and your instrument manual before you attempt to install your GC(s).

Key Words:

- GC systems ● gas delivery ● gas management
- carrier gas

Foreword

One of the most important elements in ensuring optimum performance from a gas chromatographic system is wise management of the various gases required by the instrument. This bulletin will assist analyst and lab manager alike in designing and installing gas delivery systems for gas chromatographs. It encompasses all aspects of gas management, from gas sources and gas purity to safety considerations.

In designing a GC system numerous questions arise: What types of gases will I need, and at what purity? Should I use compressed gas cylinders or gas generators? Will this system meet my future expansion needs? What are the safety and fire hazards, and how do I handle them?

To approach these and many other issues in the most logical manner, we have organized the information pertaining to system design according to the complexity of the system. Simplest is the single chromatograph installation with no consideration for expansion. More complicated is the installation of a bench of (typically) 2-4 GCs. Most complicated is the system of several benches or a lab of GCs, typically up to 20 units. Information and diagrams specific to each of these situations are presented in the latter part of the bulletin. Preceding the system-specific material is information necessary for decision-making by all chromatographers: comparative merits of gas cylinders and gas generators, how to decide on and attain suitable gas purity, how to choose, clean, and connect tubing, testing for leaks, and other subjects common to all systems.

Contents

Foreword	
Basic Installation Concerns	
Power Requirements	1
Gas Choices	2
Cylinders or Generators?	2
Gas Purity	4
Regulators and Associated Connectors	6
Tubing and Plumbing	
Tubing Choices	7
Cleaning	8
Cutting – Reaming – Bending	9
Valves and Fittings	9
Making Connections	10
System Assembly	11
Finding and Eliminating Leaks	12
Purging	13
Purifier Connections	13
Installations	
Single GC	13
2-4 GCs	14
5-20 GCs	24
Additional Resources	24

Basic Installation Concerns

Power Requirements

Whether you are planning a single GC, GC bench, or GC laboratory system, we recommend you have a qualified electrician review your power needs and recommend a suitable power system. Be ready to provide an estimate of the total power requirements for all GCs and associated equipment. A typical GC consumes approximately 2100 watts and requires a 15-20 amp *dedicated, grounded* outlet, to ensure it will not be affected by transient signals from other sources (elevator or machinery motors, vending machines, fluorescent lights, etc.). Add to this the power needs of the integrator, plus peripheral equipment which you anticipate using (autosampler, thermal desorber, pyrolyzer, etc.). The integrator or data system should be on the same outlet or circuit as the GC from which it is acquiring data. This will help prevent ground loop currents and reduce baseline noise. Equipment requiring electric actuation, such as electric valve actuators, should be on a separate line. Be sure that the outlets will be located near the instruments, and will be in sufficient number to meet current and future needs. Never use an extension cord of any type or rating to connect a gas chromatograph.

It is important to have isolated and insulated grounding for these instruments. In most plants, water lines and other sources of grounding are used so heavily that they will not provide adequate grounding. Maximum allowable line noise on a ground line is 3V (rms), from 30Hz to 50Khz. We also recommend incorporating surge protection in these lines.

Gas Choices

The gases you will need for your chromatograph are a function of the types of detectors you will use and the particulars of your analyses. Table 1 lists typical GC detectors and the gases used with each. The preference for one carrier gas versus another also can differ from one analysis to another. A chromatograph equipped with two typical flame-type detectors will require carrier, fuel (oxidant) and, for some analyses, make-up gas, in the amounts shown in Table 2. Consult your instruction manual for specific gas requirements for your instrument.

List the types of detectors you anticipate using, and their carrier, fuel, and makeup gas needs. You will need a separate line for each gas. A general purpose system with several types of detectors typically has five dedicated lines: helium, nitrogen, hydrogen, air, and actuator (usually inexpensive compressed air), plus an auxiliary line. The auxiliary line anticipates a future need for a special gas, such as argon or argon/methane or hydrogen/helium blends.

Do not use carrier, fuel, or makeup gas as an actuation gas. Device actuation will temporarily disturb the gas supply to the GC and affect its performance. Also, the quality of the gas used for valve actuation is not demanding, so there is no need to use high purity gas for this purpose. On the other hand, the actuation gas must be oil- and particle-free, for long-term best performance from the actuation equipment.

Cylinders or Generators?

Chromatographers traditionally have used compressed gas cylinders, but today, primarily for safety and practicality, gas generators are becoming increasingly common. If you choose to use cylinders or tanks, your gas supplier can help you determine the sizes and numbers of cylinders you will need, and can help you design the plumbing for your system. Your supplier can provide cradles of 6 or 8 cylinders, already manifolded. A single line connects the cradle to your house line. Depending on the size and needs of your system, you also can use Dewars, bulk tanks, or tube trailers as sources of compressed gases.

On the other hand, gas generators can greatly simplify plumbing systems and eliminate the need for handling high pressure and/or flammable materials. Because these compact units typically can be located very near the instruments they serve, they eliminate the need for long gas lines and cylinders mounted in hallways. Compact, high purity, worry-free and safe generators of nitrogen, air, and hydrogen are available. Hydrogen generators, in particular, provide important safety advantages. Relative to cylinders, the total amount of stored gas is small, and pressures are much lower. This significantly reduces the risk of explosion. Safety devices internal to most generators shut down the unit when the pressure surges or suddenly drops. Maintenance time spent on generators is less than that spent on changing cylinders.

Hydrogen Generator

Hydrogen generators electrolytically break water down into hydrogen and oxygen. The hydrogen is purified for chromatography and the oxygen is vented. When used with a downstream water trapping system, such as a molecular sieve trap and an OMI™ indicating trap in series, a hydrogen generator will provide GC-quality hydrogen for both carrier gas and detector fuel use. New models of hydrogen generators produce hydrogen at a purity of 99.99999+%, and internal purifiers in these models eliminate the need for additional downstream purification.

To determine how many hydrogen generators you will need, calculate expected flow needs based on the number of GCs and the types of detectors and other equipment you will be using (Tables 1 and 2 and your instrument manuals). Once you know how much hydrogen you will need, you can determine which model or models will meet that need (Table 3).

Hydrogen generators require deionized water of 500,000 ohm/cm resistance, or greater, or a sodium hydroxide solution. At any time, the total volume of gas in the unit is small, and the pressure is low. Most units have a pressure relief valve, set for a pressure slightly above the normal operating pressure. Other safety devices within the generator also ensure pressures cannot exceed the specified maximum, and shut down the unit if the pressure suddenly drops. The emergency vent port on the back of any hydrogen generator should be properly plumbed and safely vented.

Table 1. Gases Used with Commonly Used Detectors

Detector	Carrier Gas	Fuel Gas	Make-up Gas
ECD	nitrogen, argon/ 5% methane	none	nitrogen, argon/ 5% methane
ECD	helium	none	argon/5% methane
ELCD, Hall®	helium, hydrogen	hydrogen	none
FID	helium, hydrogen, nitrogen	air + hydrogen	nitrogen, helium, hydrogen
FPD	nitrogen, helium	air + hydrogen	same as carrier gas
HID	helium	none	helium
NPD	helium, nitrogen, hydrogen	air + hydrogen	helium
PID	helium, hydrogen, nitrogen	none	nitrogen, helium
TCD	helium, hydrogen	none	same as carrier gas

Table 2. Gas Requirements of Gas Chromatograph Systems with Flame-Type Detectors*

Gas	Flow/Column (cc/min)	Total (cc/min)
<i>Dual packed column GC with 2 detectors</i>		
Carrier	20-60	40-120
Air (fuel)	350	700
Hydrogen (fuel)	30	60
<i>Dual capillary GC with splitters and 2 detectors</i>		
Carrier	0.5-10	1-20
+ Split	100	200
+ Septum purge	4	8
Total	105-114	209-228
Make-up gas**	30	60
Air (fuel)	350	700
Hydrogen (fuel)	30	60

*Other detectors may not require fuel gases. See Table 1.

**Often, but not always, the same gas as the carrier.

Table 3. Hydrogen Output of Packard Hydrogen Generators

Model	Flow (cc/min)	Max. Pressure (psig)
9100	0-125	90
9200	0-250	90
9400	0-500	90
9800	0-1200	100

Air Generator

An air generator is, in fact, a sophisticated air purifier. The source of air typically is house compressed air or low-grade compressed air cylinders. When properly installed (Figure A), a zero air generator will provide air at a purity exceeding the quality demands of your GC.

As with hydrogen, determine your air requirements from Tables 1 and 2 and your instrument manuals. One unit can provide ultra high purity air to multiple detectors. Be sure to plan for extra capacity, even if it means buying an extra unit – generators should not be constantly operated at 100% of capacity.

Operating efficiency of a zero air generator is maximum if the incoming compressed air contains less than 200ppm total hydrocarbons and particles smaller than 7 microns. Compressed air plumbing systems can contain rust, oils, and condensed liquids. To remove oils, sulfur-containing compounds, and halocarbons from the source air, install an oil-removing (coalescing) filter, a vapor-removing filter, and a hydrocarbon trap before the generator (Figure A). If your plant air system does not sufficiently dry the air, install a molecular sieve drying tube between the coalescing filter and the generator inlet. A coalescing filter within the generator removes the last contaminants from the air.

A zero air generator operates best when supplied with compressed air at 125psig or less and a flow of 2500cc/min or less. Upstream from the hydrocarbon trap, install a single-stage pressure regulator with a pressure gauge which will show operating pressure to at least 125psig. We suggest a gauge which will show pressures to 200psig.

Nitrogen Generator

There are two approaches to generating pure nitrogen. In one approach, compressed air is passed across a semipermeable membrane that allows nitrogen to pass and almost completely bars other air components and contaminants. As the flow rate is increased, however, oxygen breakthrough increases. The second approach is a two-stage process. In the first stage, hydrocarbons in the inlet air supply are oxidized, producing carbon dioxide and water. In the second stage, oxygen and the carbon dioxide and water generated by hydrocarbon oxidation are adsorbed by carbon molecular sieves (“pressure swing adsorption”). Both methods work well – we recommend selecting a unit based on the flow needs and purity requirements of the applications you intend to use (remember to allow for future changes).

Passing the nitrogen leaving the generator through supplemental purifiers can reduce the oxygen, carbon dioxide, and water levels in the nitrogen even lower than the sub-parts-per-million levels passed by the generator.

Calculate the nitrogen needs of your system, based on the number of chromatographs and types of detectors you plan to use (Tables 1 and 2 and your instrument manuals). Be sure to plan for extra capacity – we do not recommend long-term operation of any gas generator at full capacity. To obtain the best performance from the nitrogen generator, remove water, dirt, rust, and oils from the incoming compressed air in the same manner as for a zero air generator (Figure A).

Be aware of the flow needs of the gas generator(s) you will be using. With air generators there is an almost 1:1 ratio of incoming gas flow to product gas – a little extra flow is suggested, but there is almost no flow loss. With nitrogen generators, however, this is not the case. Most of these units, independent of the purification approach (semipermeable membrane or contaminant adsorption), require large quantities of input air to produce the desired output flow. Typical air flow needs versus nitrogen delivered are summarized in Table 4.

Compressors

Look critically at the source of your compressed air. Older facilities typically have oil-sealed compressors. The longer they run to meet your gas needs, the hotter they become. This leads to oil and water vapors in the air stream. You can make either of two choices: you can install a series of special filters to reduce the hydrocarbon level in air leaving the compressor to less than 100ppm (particle filter, oil-removing/coalescing filter, and oil vapor-removing filter, as shown in Figure A), or you can replace the compressor with an oilless unit.

Most air compressors have built-in water vapor traps, but the heat generated by the unit can cause significant amounts of water vapor to still be present in the air produced. A water vapor trap downstream from the hydrocarbon trap will reduce the water content in the air (Figure A). Depending on whether the compressor is oil-sealed or oilless, the quantity of hydrocarbons will vary greatly. Even an oilless compressor can allow hydrocarbon levels that should cause concern. (The location of the air intake for the compressor is very important in determining hydrocarbon levels).

Figure A. Filters and Traps Ensure High Quality Incoming Air for a Zero Air Generator (or for a Nitrogen Generator)

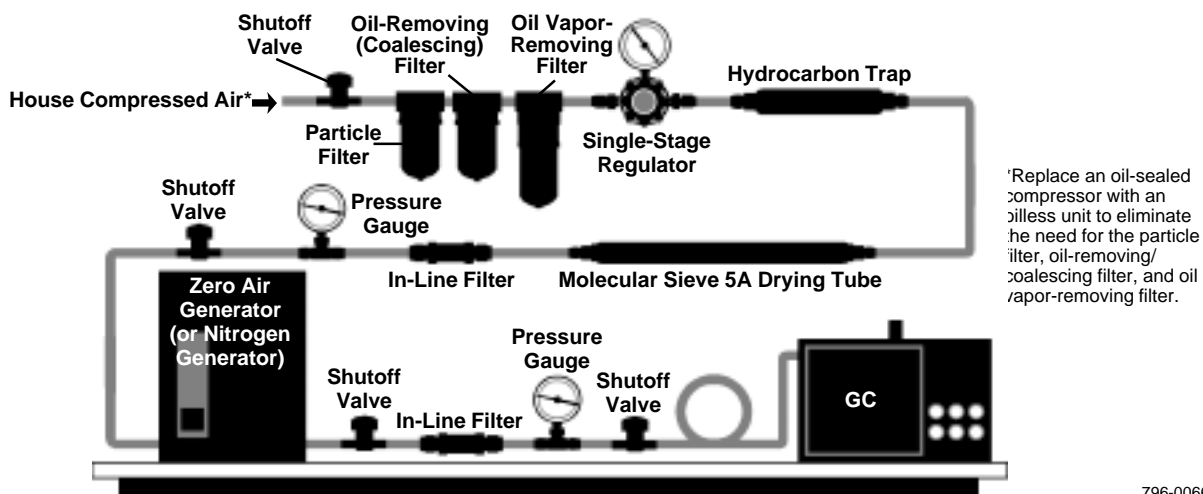

796-0066

Table 4. Air Flow Need versus Output of Nitrogen Generators

Nitrogen Generator	Air Consumption (liters/minute)	Nitrogen Delivered (liters/minute)	Stated Purity*
Air Products Whatman	75	1	99.99999%
Models 75-	102	1.9 - 36.8	99.5 - 95%
Models 76-	42	0.5-2	99.99 - 99.9995%

*As flow is increased, purity is reduced.

Cylinder Safety

If you plan to use compressed gas cylinders, safety should be a primary concern. A typical cylinder for analytical instruments has a pressure of 2000-3000psig on delivery. A rupture at a cylinder valve causes rapid depressurization and can cause serious injury or structural damage to a lab.

Store cylinders in a secluded but easily accessible location. Avoid humid places where rust can form on the caps or cylinders, and locations heated by oven exhaust. Establish extra tie-down sites near the cylinder in use, to hold the extra cylinder during the changing process. In the lab, cylinder brackets should be bolted to a wall or bench – brackets with screw clamps work satisfactorily, but can become loose with long-term use. Wall-mounted brackets with 1-3 cylinder capacity are available. A properly secured cylinder cart is a safe alternative.

Always consider safety when changing cylinders or regulators. Do not move cylinders unless you have a properly equipped cylinder cart with chains to secure the cylinders in place. Never roll a cylinder or move a cylinder with the cap off. Never change a cylinder without safety equipment, including eye protection and gloves. When changing cylinders, remove the expended cylinder (label it “empty”), place it on the cart, and chain it in place, then remove the new cylinder from the cart and install it. *First secure the new cylinder in place, then remove the cap.* If the cap won't screw off, don't try to force it. Do not place any object inside the holes in the cap except a tool designed specifically for that purpose. Return a cylinder with a seized cap to the manufacturer, properly marked with the problem.

After removing the cap from the new cylinder, inspect the fitting seat. Remove any dirt you observe – it could keep the fitting from sealing properly, or it could be forced into your system. Carefully screw the regulator onto the cylinder and tighten with the proper sized wrench. Make sure the downstream pressure control knob on the regulator is turned fully counterclockwise (valve closed). Using two hands, open the cylinder valve *while standing to the side of cylinder. Never face the gauge(s) when opening a cylinder. Bourdon tubes in pressure gauges can rupture with enough force to cause serious injury.* Slowly open the main regulator valve, then slowly open the downstream pressure control knob and reestablish the proper line pressure. Be sure to indicate on or near the regulator the pressure the regulator should be reset to after a cylinder change – you might not always be present when a cylinder is emptied.

Use an electronic leak detector (*never a liquid*) to test for leaks (see Finding and Eliminating Leaks: Testing for Leaks). If there are no leaks, open the shutoff valve separating the cylinder and regulator from the rest of the system. If you find leaks between the cylinder and the system, close the cylinder valve (For the correct procedure for relieving pressure in a two-stage regulator, refer to Additional Comments on Regulators on page 7 of this bulletin.). Unscrew the fitting and be sure there is no dirt on the fitting or cylinder seat. If there is no dirt on the fitting and the leak persists

Figure B. Sealing Point in a CGA Connection

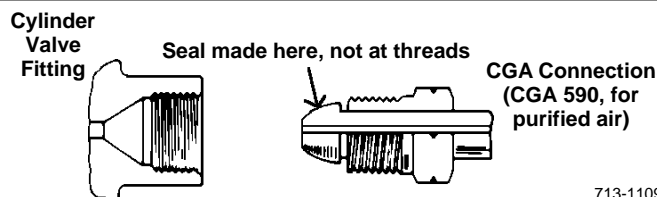

713-1109

you may need a new fitting, or the seat of the fitting in the cylinder valve may be damaged. If the fitting or the seat is damaged, using Teflon® tape on the fitting will not work – the sealing point is at the end of the fitting, not on the threads (Figure B).

Note: For detailed information on safe handling of cylinders and regulators, refer to *Safety Measures for Pressure Reducing Regulators* (Order from Air Products and Chemicals, Inc., 7201 Hamilton Boulevard, Allentown Pennsylvania 18195-1501 USA.)

When to Change a Cylinder

To be sure that the cylinder has not equilibrated with room air, most gas suppliers request a minimum residual pressure of 25psig in a cylinder. If no pressure is present they must specially clean and prepare the cylinder before re-pressurizing it. Also be aware that as the pressure decreases in a cylinder the concentrations of contaminants in the gas might increase, because they can more easily pass from the liquid state to the gaseous state. This is especially true of water – there will be a much higher concentration of water in gas delivered at low pressure from a partially-used cylinder than in gas from a new cylinder. For this reason, we recommend changing carrier gas cylinders when the pressure drops to 100-400psig.

Gas Purity

Gas purity in a GC system can be a confusing issue. In general, chromatographers agree that oxygen, water, oils (hydrocarbons), carbon monoxide, carbon dioxide, and halogens in gases supplied to a chromatograph can cause baseline disturbances, ruin columns, and/or damage detectors. Also, experiments confirm that gases that meet the specifications in Table 5 will protect all GC equipment discussed in this bulletin. Beyond these points, however, agreement ends. Some chromatographers use only ultra-high purity gases. Others, with equal experience, use lower grades of gas and depend on in-line purification to provide the purity indicated in Table 5. Still others argue that gas purification usually is not needed and fairly low grades of gases can be used routinely.

Table 5. Acceptable Purity Levels for Chromatography Grade Gases*

Gas	Impurity / Maximum Concentration				Total Hydrocarbons
	O ₂	H ₂ O	CO ₂	CO	
Helium	<1.0 ppm	<1.0 ppm	<1.0 ppm	<1.0 ppm	<1.0 ppm
Nitrogen	<1.0 ppm	<1.0 ppm	<1.0 ppm	<1.0 ppm	<1.0 ppm
Air	20-22%	<1.0 ppm	<1.0 ppm	<1.0 ppm	<1.0 ppm
Hydrogen	<1.0 ppm	<1.0 ppm	<1.0 ppm	<1.0 ppm	<1.0 ppm
Argon/ methane	<1.0 ppm	<1.0 ppm	<1.0 ppm	<1.0 ppm	<1.0 ppm

*These limits are set to protect the column. Detector limits usually are less demanding.

Several facts can bring a rationale to the gas purity arguments. Water and oxygen damage a column by reacting with the phase. Although exact temperatures at which this damage begins to occur are not known, and probably differ among types of phases and columns, reported damage consistently has been at tempera

tures of 140°C or above. Similarly, baseline disturbances due to oxygen, CO, and CO₂ are consistently reported at medium or higher detector sensitivities. Therefore, if you intend to use low temperatures and nondemanding detector sensitivities, you might be able to use gases that do not meet the purity criteria in Table 5. For all but a few selective detectors, however, you should still be concerned about hydrocarbons in your gas, and use gas which has very low hydrocarbon levels. Although some suppliers of chromatography products are not concerned about hydrocarbons in gas streams, we strongly recommend using a hydrocarbon trap even if the gas is low in total hydrocarbons.

Gas Purifiers

Like the basic need for pure gases, the use of in-line gas purifiers versus ultra high purity gases has been debated by analysts for years. Because there are many sources of contaminants in addition to the gas cylinder, we recommend using gas purifiers to protect your instruments. Often, the greatest source of contaminants is the process of changing cylinders, which creates an opportunity for room air to enter both line and cylinder. In-line purifiers remove this surge of impurities and keep them from entering the instrument. Unclean tubing can be a major source of oils and other contaminants (see Tubing and Plumbing: Cleaning). Regulator diaphragms can be a source of hydrocarbons, and oxygen can permeate through the diaphragm. Greases and/or lubricants used in the body of a valve can be sources of hydrocarbons. Every fitting in the system potentially can allow room air, and its associated contaminants, to leak into the system. Even a system that is initially leak-free can develop leaks over time, due to expansion and contraction of tubing and fittings with the changing temperatures in the lab. Indicating (color changing) in-line purifiers, available for oxygen, water, hydrocarbons, and other contaminants, give visual warning that contamination is present. In some purifiers, a pressure drop develops between inlet and outlet as the purifier's capacity is reached, and acts as the signal for changing the purifier. This means installing pressure gauges at each end of the purifier and routinely monitoring the pressure. Typically, the purifier should be changed when the pressure drop reaches 10-15psig.

For ultra-demanding applications requiring the highest possible gas purity, there are special purifiers and connectors. The Aeronox GateKeeper purifier reduces contaminants to the sub-parts-per-billion level. A combination of special design factors allows the purifier to reach these levels. The catalyst, a nickel material, reacts with a variety of contaminating materials and permanently removes them. Specially electropolished inner surfaces and special endfittings – face seal fittings (Figure C) – then maintain the purity level. (Standard compression fittings are very good, but

Figure C. Face Seal Fitting

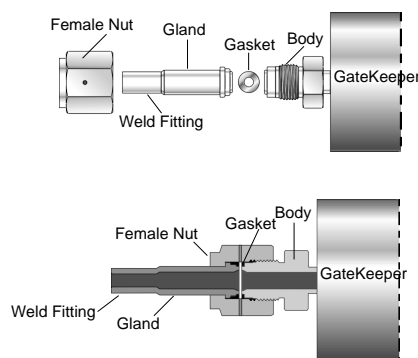

797-0086, 0085

cannot completely eliminate trace leaks that allow ppb levels of contaminants.) Few chromatographers, however, need this challenging level of gas purity.

Carrier gas purification should start with large capacity (bulk) purifiers for trapping hydrocarbons, water, and oxygen, in that order, in the main gas lines. If the order is changed the lifespans of some of these devices could be shortened. Smaller capacity purifiers and in-line filters should be installed in each carrier gas and make-up gas branch line, as close to the GC as possible (Table 6). The OMI™ purifier provides final purification of carrier or make-up gas. Its capacity is smaller than that of bulk purifiers, but it will provide many months of operation if lines are leak-tight and properly maintained. The color indicator in an OMI purifier changes from black to brown as the material (Nanochem® resin) is expended. For more information on the OMI purifier request Bulletin 848. We also recommend using a hydrocarbon trap in the fuel gas line.

Additional Comments on Gas Purifiers

The color change line visible through the wall of a color-indicating purifier is not the most forward point at which the purifier material is expended. There is a tunneling or funneling aspect to the purification process – the core of the purifier is expended before the outside edges. Therefore, you should change the purifier when the color change is about 75% along the tube – the front of the cone of expended material will be much closer to the outlet end of the tube. For convenience, we mark the “time to change” point on the body of the OMI tube (Figure D).

Table 6. Recommended In-Line Gas Purifiers (Purifiers described on products pages)

Purifier	Removes	From	Indicating?
Supelpure-HC Trap	hydrocarbons	all gases	no
Molecular Sieve 5A	water, heavy hydrocarbons	air, hydrogen, nitrogen, helium	no
High Capacity Purifier (heated purifier)	oxygen, water	helium, nitrogen <i>do not use with hydrogen or air</i>	yes (pressure)
OMI	oxygen, water, CO, CO ₂ , alcohols/phenols, sulfur- and halogen-containing compounds	argon, helium, nitrogen, hydrogen, argon/methane, neon	yes (color)

Figure D. Partially Used OMI Purifier with "Time-To-Change" Marking

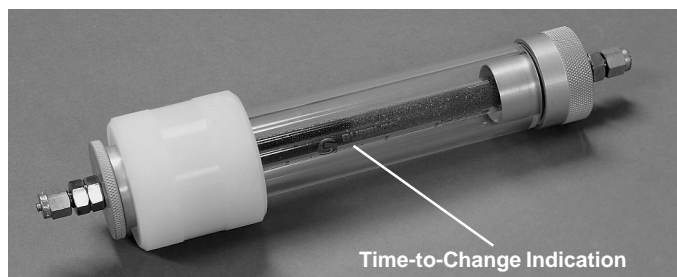

996-0054

Not all purifiers on the market are adequate for use in carrier gas lines. Purifiers constructed from plastic tubing tend to allow water and oxygen to permeate into the gas line. Most water-removing purifiers using Drierite® and similar color indicators do not completely remove water. Also avoid purifiers which have O-ring seals; they typically leak, especially on re-tightening or on the second installation. We recommend the purifiers in Table 6 for removing the gases indicated to levels acceptable in carrier gas. Purifiers constructed of plastic, or filled with low-efficiency adsorbents, are adequate for air lines.

In-Line Filters

To protect needle valves, regulators, flow controllers, and other devices, each gas line should contain a filter capable of removing particles 7-10 microns in diameter (see products pages of this bulletin). The filter in a two-stage regulator will not trap particles this fine.

Regulators and Associated Connectors

Two types of regulators are used in a well-designed gas supply system. At each gas cylinder is a two-stage regulator. The first stage reduces the pressure of gas coming from the cylinder to 300-500psig, then the second stage reduces the pressure to the pressure desired in the main line (Figure E). If you use a single-stage regulator at the cylinder, you must constantly adjust the main line pressure as the pressure in the cylinder is reduced. With a

single-stage regulator, downstream line pressure will increase at a rate of 0.65psig per 100psig decrease in cylinder pressure. This change in downstream pressure may be unacceptable. (Note: two pressure gauges do not always denote a two-stage regulator. Some single-stage regulators have an inlet and outlet gauge.)

In multiple-unit GC systems, the branch line to each chromatograph should include a single-stage regulator, to step down the pressure in the line to that required by the instrument.

There is another reason why both two-stage and single-stage regulators are used in a GC system. To ensure effective operation, you must maintain at least a 10-15psig pressure differential across all flow and pressure-controlling devices (Figure F). Pressure in the mainline can change because of new demands, because the cylinder pressure output is not properly reset when a cylinder is changed, because the system has long plumbing lines (pressure will be lowest at the most remote instruments), or because pressure will vary during a temperature programmed analysis. To ensure that you maintain a 10-15psig pressure differential, you must know the pressure of the gas as it enters the GC and at the head pressure gauge on the instrument. A system with a two-stage regulator at the cylinder and a single stage in-line regulator at each chromatograph provides this information. Without a single-stage regulator just before each instrument, changes in the main line pressure will affect the operation of the individual GCs.

Not all commercially available regulators are suitable for use with GC carrier gases. The critical component is the diaphragm. The Buna-N or neoprene diaphragms in most regulators off-gas contaminants and are permeable to water and oxygen (see Scott Specialty Gases laboratory report No. E-R83-1, request from Scott Specialty Gases, Plumsteadville, PA, USA). A regulator with a stainless steel diaphragm eliminates these problems. On the other hand, regulators constructed entirely of stainless steel, intended for use with corrosive gases, are very expensive and are not needed for GC applications.

Gas generators develop much lower gas pressures than the pressures delivered from cylinders. A single stage regulator is suitable for regulating gas flows from these devices.

Figure E. Gas Flowpaths in Single-Stage and Two-Stage Regulators

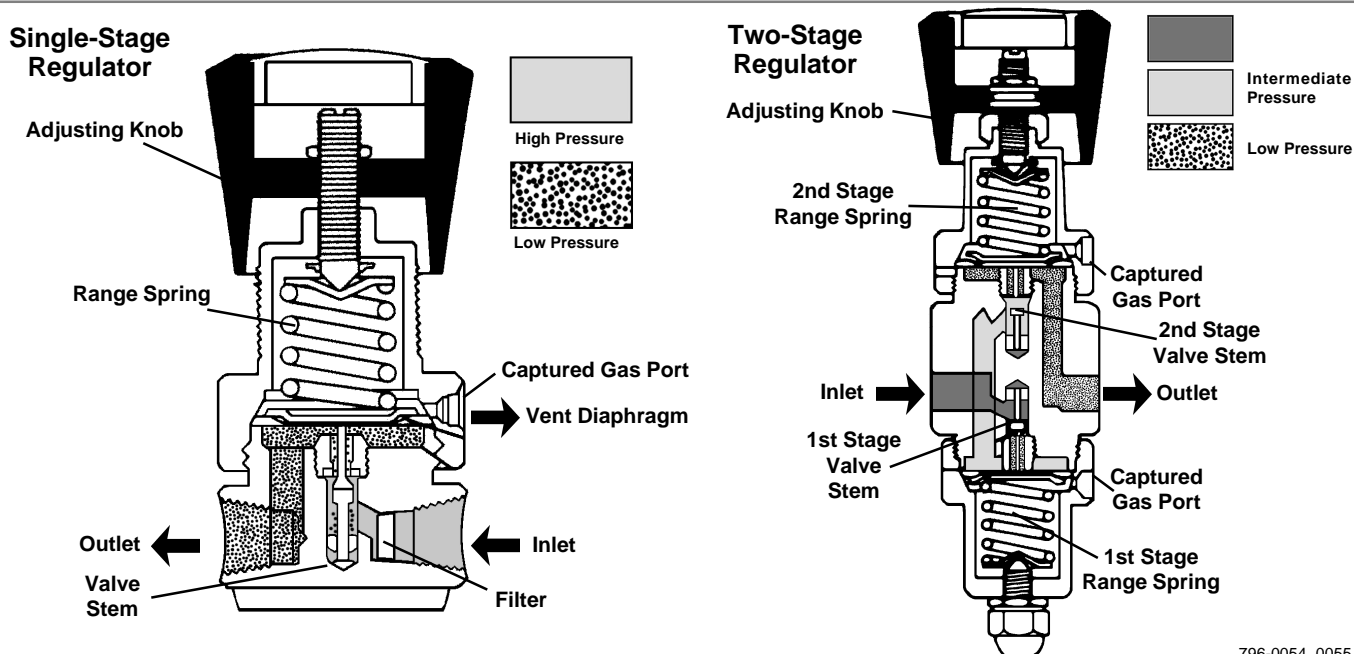

796-0054, 0055

Regulators used in an air line can be fitted with a neoprene diaphragm. These regulators will reduce installation costs without sacrificing the integrity of the system.

Be sure to read the product specifications before you buy a regulator. A regulator with two pressure gauges is not necessarily a two-stage regulator.

Additional Comments on Regulators

Modern gas chromatographs are factory set to operate at column head pressures of up to approximately 60psig. In some GCs, very long columns (e.g., 100+ meter capillary columns) can require column head pressures up to 90psig. Typically, the line pressure should be 15-20psig higher than the inlet pressure to the GC and, as discussed above, for pressure regulators and flow controllers to work correctly there must be a 10-15psig difference between the input pressure and the maximum output pressure the devices will be expected to deliver. Consider these values in deciding what pressures to use in your system – higher pressures may require you to change some internal pressure gauges in your GC.

Figure F. To Ensure Effective Operation, Maintain At Least a 10-15psig Pressure Differential Across All Flow and Pressure-Controlling Devices

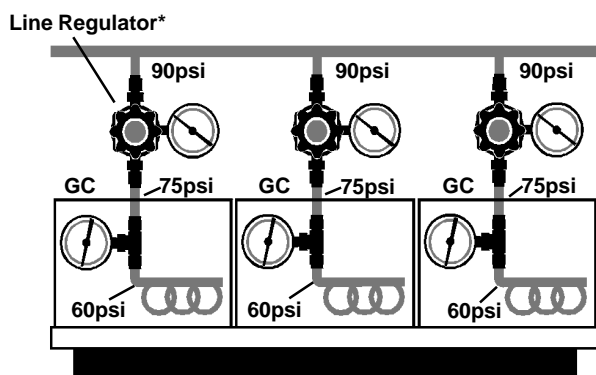

* Simplified diagram, does not show shut-off valves above and below pressure regulator (see Figure X).

796-0067

Never remove a two-stage regulator from a gas line with a high pressure isolated in the first stage – the sudden release of pressure could rupture the diaphragm, ruin diaphragms in downstream regulators, and/or create gaps in a packed column (the packing could even be forced out of the column). Always depressurize a two-stage regulator through the second stage. If your system has a single-cylinder gas supply, or a gas generator, the first step is to turn off the GC oven and let the column cool. In a two-cylinder system, transfer flow to the second cylinder. Next, close the first stage (cylinder side) valve on the regulator to be removed from service, while leaving open the shutoff valve after the regulator. This will allow the gas remaining in the regulator to pass through the regulator. Vent the pressure through the system (be sure the column is cold), through a vent installed in the gas line, or through the vent on the regulator itself (some models). Finally, close the downstream pressure control valve and remove the regulator.

Whenever you change cylinders or regulators, be sure to protect the columns in the chromatograph. Before you disrupt the gas flow, either switch to a second source of gas or, if you are disrupting carrier gas flow, turn off the oven(s) and cool the column(s) supplied by the gas.

Always use a regulator rated for your intended application. Never switch CGA, or other, fittings to use a regulator for a purpose for which it was not intended (e.g., do not refit any regulator for oxygen delivery). Table 7 lists the proper CGA fittings for each type of gas used for GC. Never switch gauges or inlet fittings and never change gas service. Never close a regulator body in a vise to remove a fitting – this almost certainly will break the diaphragm seal and cause the diaphragm to leak. Never lubricate a regulator or use pipe sealants.

The regulators we offer supply a maximum of 100psig and have gauges that read to 200psig in 5psig intervals. Regulators that can provide much higher pressures are available, but we do not recommend these for GC use. It is difficult to regulate a pressure to within a few psig on a 2000psig regulator with gauge gradations in 20psig intervals.

Be sure to indicate, on or near each regulator in your system, the pressure the regulator should be reset to after a cylinder change – you might not always be present when a cylinder is emptied and replaced.

The American Society for Testing and Materials (ASTM) summary book on chromatography, and related ASTM publications, provide “lab-tested” guidance to the practicing chromatographer (order from American Society for Testing and Materials, 100 Bar Harbor Drive, West Conshohocken, Pennsylvania 19428-2959 USA).

Table 7. Regulator Fittings

CGA Connections (all 0.965")				
Gas	Outlet Description	Nipple Shape	Nut	Thread*
Air (purified)	590-14LH	bullet	male	left
Argon	580-14RH	bullet	male	right
Argon/Methane	350-14LH	round	female	left
Helium	580-14RH	bullet	male	right
Hydrogen	350-14LH	round	female	left
Nitrogen	580-14RH	bullet	male	right
Other Connections				
Gas	DIN 477	BS 341	Japan	
Air (purified)	13	3	—	
Argon	6	3	W22-14 - right	
Argon/Methane	1	4	—	
Helium	6	3	W20.9-14 - left	
Hydrogen	1	4	W22-14 - left	
Methane	1	—	—	
Nitrogen	6	3	W22-14 - right	

*There is always a groove in a nut with left-handed threads (see Figure B).

Tubing and Plumbing

Tubing Choices

Many types of tubing are available for supplying air, helium, nitrogen, argon, and gas mixtures for gas chromatography. In practice, however, only copper and stainless steel are viable alternatives. Table 8 lists the specifications for tubing suitable for use in gas chromatography. Before use, this tubing must be cleaned to remove traces of oil and dirt. Regular grade metal tubing offered in chromatography catalogs usually is adequately cleaned for plumbing purposes. Column-quality tubing receives additional acid and base cleaning and is chromatographically tested for active sites. This extra treatment is not needed for gas lines. Tubing obtained from building supply houses or hardware stores is not clean enough for use – our chemists have seen oil

dripping from the vent ports of TCD detectors when non-chromatographic grade tubing was used, uncleaned, to plumb a GC system. Similarly, the dirt in commercial tubing can clog the frits in flow controllers and other fine metering valves, and ruin these devices. To be sure of the quality of the tubing used in your lab, discuss the Tubing and Plumbing section of this bulletin with the suppliers and fabricators of your gas supply system.

Table 8. Tubing and Tubing Preparation for Gas Chromatography

Tubing Type	For Columns	For Plumbing
Stainless Steel*	premium grade 304	regular grade 304
Copper**	highly cleaned	cleaned
Aluminum	highly cleaned	not recommended
Nickel	SP-Alloy (T-1)	not recommended
Teflon®	TFE or FEP	not recommended
Tygon®	not recommended	air lines only

*Conforms to Schedule 40 ASTM A213, RB80

**Type K hard tempered

Stainless Steel Tubing — Strong and reusable, stainless steel tubing is always the best choice – and the most costly – for a GC system. For hydrogen, mill-finished, oxygen-cleaned 304 or 316 grade stainless steel tubing (never copper) should always be used. Care should still be taken to clean this material. For special applications where pristine conditions are needed, such as with helium ionization detectors, 304L electropolished (EP) stainless steel with vacuum coupled replaceable (VCR) connections and orbital weld joints is the best choice. An electropolished surface significantly reduces water and contaminant capture. It can be very expensive, but for critical applications it is worth the added expense.

Copper Tubing — Due to its lower cost, copper tubing is the most commonly used plumbing material in GC systems. Copper should not be used with hydrogen gas, nor where the gas line might be flexed. With time copper tubing of any diameter work-hardens and is very easily broken during flexing. Because copper tubing has a much smaller inside diameter than stainless steel tubing (1.65mm versus 2.1mm), only very short lengths of 1/8" copper tubing should be used (Table 9). Long lengths lead to high back pressures. (Even stainless steel gas lines should be as short as possible.) 1/4" OD copper tubing is by far the most common diameter of copper tubing used – it tends to be stronger than 1/8" tubing, but with flexing it can still break. 1/2" OD copper tubing typically is inflexible. Consequently, Swagelok® or soldered fittings are needed for all direction changes and connections in 1/2" copper lines.

Table 9. Recommended Lengths of GC Gas Lines

Material	Outside Diameter	Maximum Length (feet)
Copper*	1/8**	6
	1/4	20
	1/2	100
Stainless Steel	1/16	2
	1/8	10
	1/4	20
	1/2	100

*Do not use with hydrogen.

**Not recommended due to brittleness.

Additional Comments on Tubing

Never use cast iron or black steel pipe to supply gases to chromatographs. Over time these materials will form rust which will travel through your system, ruining valves, regulators and other components.

Soft and easily kinked when new, aluminum tubing, like copper tubing, becomes brittle over time. Because aluminum tubing offers no particular advantages relative to copper, and has a higher degree of the same disadvantages, we do not recommend using aluminum tubing to plumb a GC system.

Teflon and nylon tubing are acceptable for air and actuation lines, but permeability to water and oxygen precludes the use of these or other polymeric materials for most GC plumbing needs, including carrier gas and make-up gas lines. Hydrocarbons from some polymeric tubing can appear as impurities in the system. In a well-designed plumbing system, a regulator can fail and release full cylinder pressure into a line, and the line will withstand the pressure. Polymer tubing will not pass this test.

Cleaning

Dirt and oil are present in all tubing as a result of the manufacturing process. Only if you buy cleaned tubing from a chromatography supplies dealer will you receive tubing immediately ready for chromatography. Even then the tubing must be capped to keep dust and dirt out during shipment and the system assembly process. During cutting and assembly processes, metal fragments and dirt can get into the tubing. It is best to clean the tubing, assemble it, blow it out, and purge it.

The first concern is the removal of dirt and oil used during the manufacturing process. If you have any intention of using an electron capture detector, at any time, do not clean the tubing with chlorinated solvents. Using a nonpolar solvent such as n-hexane, flush the tubing until the solvent flowing out of the line is clear. Allow sufficient time for the solvent to dissolve materials in the line. Rinse the tubing with water to flush the hexane and absorb any free acidic or basic material. Next, flush with methanol, to remove traces of hydrocarbons and the water remaining in the tubing. Using clean nitrogen (not compressed air, which always contains some oils), attempt to remove all traces of methanol. Coiled tubing can be put in a large oven and heated to 110°C during the nitrogen purge.

Clean tubing should be capped in some fashion to keep dirt out. If caps are not available, flatten the ends of the tubing and fold each flattened end back on itself (Figure G).

Figure G. Tubing Crimped and Folded to Keep Dirt Out

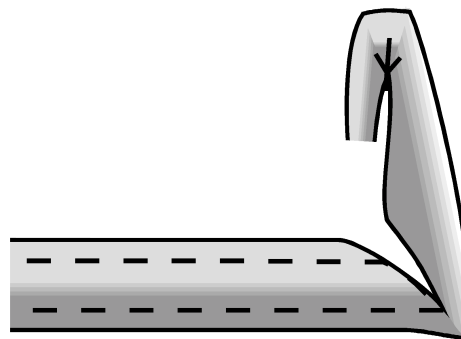

796-0074

Cutting – Reaming – Bending

To avoid creating kinks or flat spots as you uncoil the tubing, hold the coil of tubing perpendicular to a table or the floor. Hold the end of the tubing with one hand and roll the coil away from you with your other hand (Figure H).

The preferred tool for cutting copper or stainless steel tubing is a device which presses a cutting wheel against the tubing while the device is turned repeatedly around the tubing (see the products pages of this bulletin) This tool makes a very clean, truly perpendicular cut which allows the tubing to fit squarely into a fitting. Some cutting machines also work very well, especially for cutting 1/16" tubing. In contrast, general-purpose tubing cutters distort the end of the tubing and hand-held saws often leave ragged and angled cuts and excessive metal filings in the tubing.

Figure H. Uncoil Tubing without Creating Bends



996-0056

Figure I. Trim and Bevel a Newly Cut Tubing End

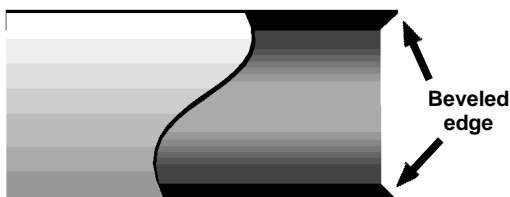

796-0075

Cutting should always be followed by reaming. When cutting any tubing, but especially when cutting copper, a soft metal, the metal typically intrudes inward and reduces the ID of the tubing, sometimes almost completely closing it. Special care must be given to re-opening the tubing to its original inside diameter. Use a tool such as Catalog No. 20389 (see the products pages) to carefully cut away excess metal and slightly bevel the inside edge of the tubing (Figure I). Remember to clean the metal filings out of the tubing, or they will be pushed into the nearest valve, flow controller, or pressure regulator, where they could cause damage. Direct a stream of clean, dry nitrogen gas through the tubing to remove the filings. Do not use air from a compressor; it might contain oils.

Bend tubing very carefully, taking care to not reduce the inside diameter or create flat spots. Use tools designed for this purpose, such as Catalog Nos. 20422-U, 20424-U, and 20857 (see the products pages). If the tubing at a bend is visibly flat, discard it. If you need a very sharp bend or there isn't room for a bend, use an elbow fitting.

Flexible Hoses — Most tubing is not designed for continual flexing. This creates a problem for attaching a regulator to a cylinder or to a gas line. The solution is a flexible metal hose (see the products pages) — a 30" length of corrugated (bellows) stainless steel tubing reinforced with stainless steel braids, with additional casing on the outside, and fitted with Swagelok, pipe thread (male) or CGA connectors. The hose can be used to connect a cylinder to a fixed, wall-mounted regulator or to connect a regulator mounted on a cylinder to a gas line that is secured to a bench or wall. The hose should be rated to 3000psig and for the gas you will be using. When the regulator is removed from the cylinder it should be properly supported — do not suspend it by the hose.

Figure J. Conventional (left) and Hydrogen Pressure Relief Valves



996-0057

Valves and Fittings

In addition to the tubing, all other system components — joints, valves, relief valves, flash arrestor etc. — must be compatible with anticipated operating pressures and temperatures. Trace contaminants usually come from O-rings, washers, elastomers, and plasticizers sometimes used in valves or other devices. Avoid this problem by eliminating elastomer valve seats and using metal-to-metal seals for all joints and seals (Military Specification grades of Teflon, T-27730A may be acceptable). Greased fittings and soldered lead joints should not be used because of potential contamination from organic greases or acid solder flux. When using copper tubing, Swagelok fittings or well fabricated brazed joints usually provide leak tight connections. 1/4-turn or 1/2-turn bellows- or diaphragm-type valves assure the best positive shutoff of gas flow (see the products pages).

Pressure Gauges — Pressure gauges should be selected by pressure range. They should exceed the pressure you anticipate using, but not greatly. It is very difficult to read 10- or 20-psig increments on a 2000psig gauge. In most GC systems, none of the gases being used will ever exceed 100psig. Pressure gauges have pipe threads. They should be attached using Teflon tape. Never use pipe sealant.

Figure K. Safely Designed Hydrogen Line (Carrier Gas)

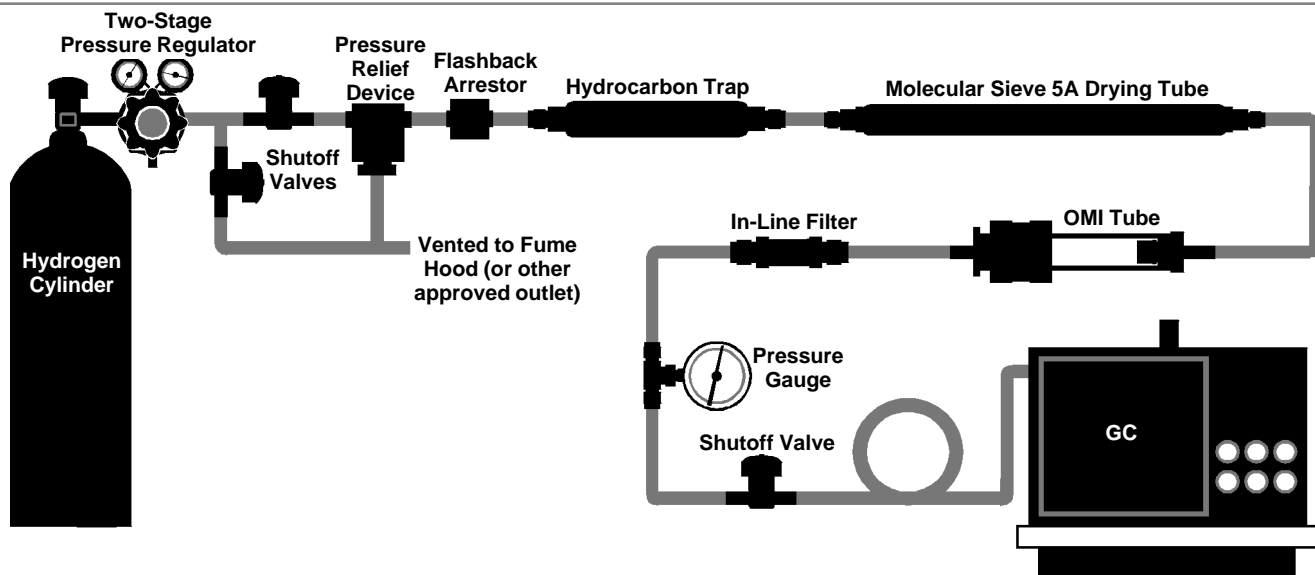

796-0068

Pressure Relief Devices — A pressure relief device is required with any flammable gas (e.g., hydrogen), whether delivered from a generator or a cylinder. A hydrogen pressure relief valve is different from most pressure relief valves in that it is designed to accept fittings which allow additional plumbing and proper venting (Figure J). Most hydrogen generators will have an internal device which should be properly plumbed to a safe vent. If you cannot confirm that your generator has such a device, install one just downstream of the generator, in conjunction with a flash arrestor (Figure K).

The pressure relief device in a hydrogen line should always be safely vented. Mixtures of 4% or more hydrogen in air are explosive. Do not allow these concentrations to form in the lab. Vent hydrogen to a fume hood or other conduit leading out of the building. Check with your safety department to determine the proper venting procedure for your site.

We recommend you install a pressure relief valve that releases pressures above 2000psig on each main gas line, to protect downstream equipment from high pressure failures. The best location for the device is after the cylinder regulator shutoff valve (Figure K). Pressure relief valves on non-flammable gas lines need not be vented to a hood, but be sure to direct the vents downward (away from operator).

Dry Flashback Arrestor — In the event of a hydrogen flashback, a dry flashback arrestor diverts the flame into a 3-foot (1m) length of tubing, where the flame is extinguished and the heat is absorbed. The shock wave preceding the flashback closes and locks the arrestor's shutoff valve, eliminating continued gas feed. Install the dry flashback arrestor after the shutoff valve and pressure relief device for the cylinder regulator (Figure K). Many hydrogen generators incorporate a flashback arrestor. If your generator does not, install one just downstream of the generator. Use only devices which meet Occupational Health and Safety Administration (OSHA) and National Fire Protection Agency (NFPA) codes, or overseas equivalents, and are Factory Mutual approved. Devices larger than the one shown on the products pages of this bulletin may be needed for large installations. They are available commercially. Dry flashback arrestors are reusable and can be reset, but be sure to determine and eliminate the cause of the flashback before resetting the arrestor.

In contrast, wet flashback arrestors, which incorporate ethylene glycol, should not be used with chromatographic systems. Although ethylene glycol is only weakly volatile, ethylene glycol vapor could be released into the gas system. This contamination will cause unstable baselines and high background signals.

Making Connections

Installation of all the lines, regulators, valves and other associated hardware needed in a GC system requires an assortment of tube, threaded pipe and, perhaps, soldered connections. When tube connections are required, always use highest quality fittings. We recommend using Swagelok fittings wherever possible. Threaded pipe connections should be sealed only with instrument grade Teflon tape (Catalog No. 20808-U). Pipe sealant (pipe dope) or other chemicals, and some lower grade Teflon tapes, contain organics which could bleed into the gas stream. Roll one layer of the tape onto the threads counter to the direction of the threading (i.e., counterclockwise) and tighten the tape. Thread the two parts together and tighten. Do not overtighten.

When soldered connections are needed, the brazing alloy should be flat stick silver solder containing 15% silver. Use MAPP® (methyl acetylene propadiene), rather than acetylene, when soldering with this high melting point solder. Use *no flux*. Flux will cause interference with electron capture detectors, and possibly with other detectors and some columns.

Assembling a Swagelok Tube Fitting

Before assembling a nut and ferrule on the tubing inspect the tubing to be sure the surface is smooth and free of longitudinal scratches, and the cut end is deburred. If the tubing is acceptable, slide on the nut with the open side facing the end of the tubing. Next slide on the back ferrule with the wider part facing the nut. Then slide on the front ferrule with the small end of the cone facing the end of the tubing (Figure L). Push the assembly about 1" (2-3cm) onto the tubing. The ferrules and nut should slide onto the tubing easily and rotate freely. Insert the tubing into the fitting – it should fit easily. *Hand-tighten* the nut/ferrule assembly onto the fitting. Then, using two wrenches, tighten the assembly. We do not recommend relying on torque measurements, due to differences in tubing wall thickness and materials of construction.

Figure L. Assembling a Swagelok Fitting

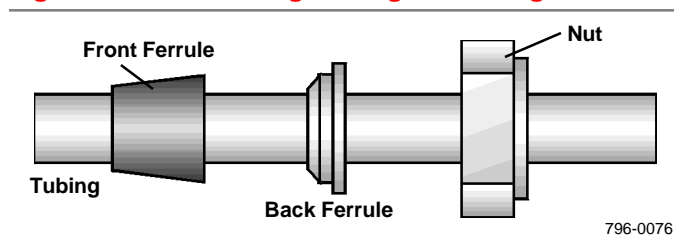
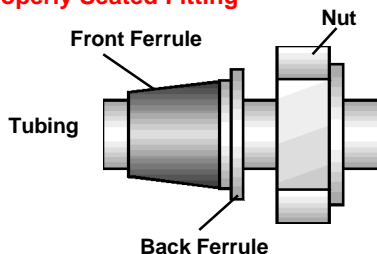
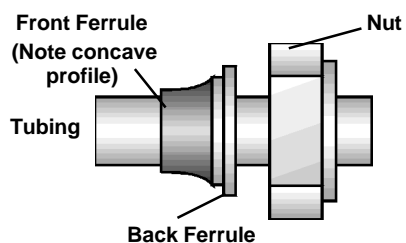

Figure M. Ferrule Profile Reveals Correct/Incorrect Tightening

M-1: Properly Seated Fitting



M-2: Overtightened Fitting



Instead, monitor the number of turns you make on the nut. If the parts are clean and properly assembled, 3/4 turn on 1/16" or 1/8" tubing, or 1 1/4 turns on 1/4" tubing, should seal the fitting. A properly tightened Swagelok ferrule system looks like Figure M-1. Notice that a properly seated front ferrule will be forced slightly into the tubing. Always use two wrenches when tightening fittings, one to hold the fitting in place and the other to tighten the nut/ferrule assembly. A tee wrench is very useful for tightening tees. A hydraulic swaging unit might be required to swage 1/2" or larger fittings. If the fitting does not seal properly, additional tightening seldom provides a leak free seal. Disconnect the nut and examine the inner surfaces of the fitting, ferrules, and tubing for dirt or scratches. If necessary, replace defective components. Figure M-2 shows the effects of overtightening a fitting. Notice the concave front ferrule. The shoulder on the distorted ferrule is typical of overtightened ferrules. The cross-sectional profile of a good ferrule is a straight edge from the tubing to the back edge of the ferrule. Never use sealing compounds on the outside of fittings to stop leaks.

For detailed instructions on swaging and other plumbing needs, refer to the Swagelok Manual (22339).

There should be no need to disassemble and inspect a Swagelok fitting if it passes your leak testing procedure, but in some facilities additional testing is required to ensure that a fitting has been sufficiently tightened. The preferred test involves using gap inspection gauges (Catalog Nos. 21984-U, 21985-U and 25822). A gap inspection gauge has a thick end and a thin end. Attempt

to insert the thick end of the gauge in the gap between the nut and body of the tightened tube fitting. If the thick end will fit, the fitting nut has not been sufficiently tightened. If the thick end will not fit the minimum requirement for tightening has been met.

Properly installed Swagelok fittings can be disconnected and re-connected many times. To re-connect a fitting simply hand-tighten the nut, then slightly tighten it with a wrench. It should take little additional pressure to tighten the fitting, because you are simply making a metal to metal seal between the ferrules and the body of the fitting, not re-seating the ferrules onto the tubing. Always confirm the reconnection is leak-free, using an electronic leak-detecting device.

Additional Comments on Connections

Never mix tube fitting components of different brands. Although products from different manufacturers appear to be interchangeable, they are not. Nuts, ferrules, and bodies will have different angles and depth specifications. Two-piece ferrules and one-piece ferrules have different mechanical sealing functions between the tubing and the fitting body. Decide on a fitting manufacturer and stay with the decision throughout your plumbing system.

For information on installing a GC column into the system, request our free Bulletin 741, *The Supelco Guide to Leak Free Connections: Ferrules and Fittings for Packed and Capillary GC*.

System Assembly

Your plumbing assembly should follow either the single GC, 2-4 GC, or 5-20 GC system described later in this bulletin. Figures in these sections show our recommendations for the various types of valves, regulators, and other devices for each system. We also recommend that you read the Swagelok *Tube Fitter's Manual* (Catalog No. 22339), especially chapter 3, *Tubing and Tube Fitting Handling and Installation*. The manual offers many tips and helpful directions which go beyond the detail in this bulletin.

Securing Fittings and Tubing

Because it is not desirable to flex the tubing when opening or closing a valve, valves and gas lines should be securely fastened to benches or walls. Many types of fasteners are available for tubing, and brackets are available for most valves (see the products pages). Tubing should be fastened down every 4-6 feet.

Though most of the plumbing in your system should be secured to a bench or wall, there should be some flexibility at the point of connection to the GC. It is a good idea to roll about 3 feet of the gas line between the shutoff valve and the GC into a coil 4-6 inches in diameter (Figure N). This will allow some lateral and front-to-back movement of the instrument when it is being serviced.

Plumbing Two Gases Together

Some analysts frequently switch carrier gases as the application for an instrument changes. Never attempt to plumb two carrier gases through the same line, through tees, valves, or other arrangements. Even with shutoff valves, flow-check valves, and other devices which are supposed to guarantee that the two gases never mix, in time they do mix, usually through human error. It takes little time to disconnect one line and attach another, and this is the best approach. If time is critical, you can use quick connect fittings for this purpose. If you use quick connect fittings, however, we strongly suggest you routinely test for leaks, and include oxygen and water vapor traps downstream.

Figure N. Coiled Tubing Allows Flexibility in Installation of a GC

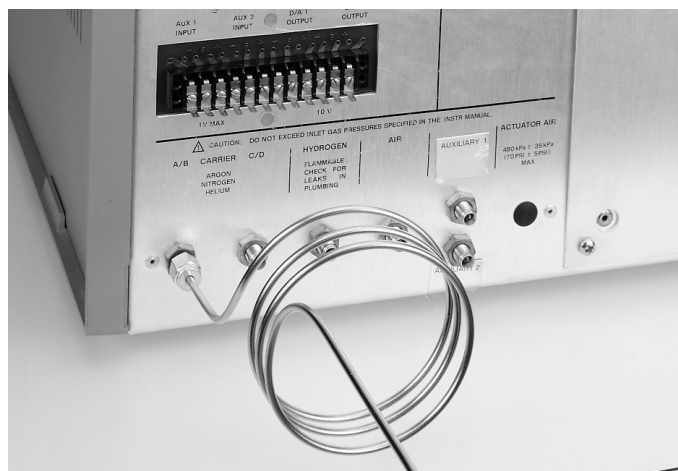

9960058

Coding Gas Lines

It is important to know what gas a valve will deliver when you open it, but when all the gas lines are in place it can be difficult to discern what line contains what gas. In Supelco laboratories each line is color coded (i.e., painted) and labeled so that analysts and repair technicians can quickly determine what gas each line contains. You can buy colored sleeves, tags, or other types of labels, or simply paint the lines in different colors.

Finding and Eliminating Leaks

Equipment Alternatives

Testing a system for leaks is often thought of as being very difficult. In truth, the initial pressure test of the entire system is very simple. If the system passes this initial test it is ready to use. Finding the leaks, if they exist, can be more difficult. Often a cylinder of oil-free air is used to sequentially check each of the gas lines in a new system for leaks – it is costly to use high purity gases, and it is not safe to leak test with hydrogen. On the other hand, helium or nitrogen will allow electronic leak testing if part of the system fails the pressure test. We recommend using high-purity helium, or a lower grade of helium passed through traps that will remove hydrocarbons, oxygen, water, and particles (see the *Installations* section of this bulletin). Helium is the easiest gas to detect with an electronic leak detector.

Pressure testing reveals the presence of leaks, but does not show where they are located. You must find leaks by using either a liquid or an electronic leak detector. *We recommend that all leak testing be done with an electronic leak detecting device, not with liquids of any kind.* Just like a kitchen sink aspirator will draw a vacuum on a small side line while water is running through the main line, a leak – small or large – will draw in gas or liquids as it allows gas to leak out. If there is a leak in a line, any liquid leak detector could be siphoned into your system and could reduce sensitivity or cause a drifting baseline. To avoid any chance of contamination, we strongly recommend using an electronic leak detector.

GOW-MAC electronic leak detectors are simple to use. Simply set the read-out to zero as only air is being drawn into the unit, then place the probe at the site to be tested and sample the air around the site (Figure O). The detector, a form of TCD, senses the thermal conductivity of the gas in the detector cell. If the detector senses gas mixtures other than normal air, the needle on the

Figure O. Leak Checking a Valve with a GOW-MAC Leak Detector

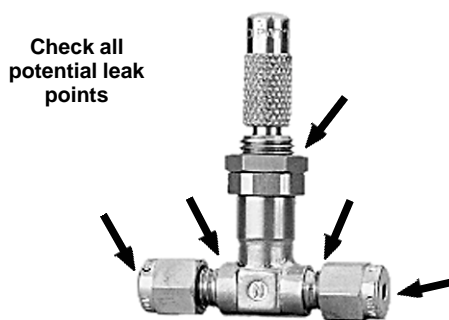

910-0076

gauge will be deflected, indicating a leak. The detector is very sensitive for helium and hydrogen. Although less sensitive for nitrogen (air is 80% nitrogen, so the differences in thermal conductivity are small), its nitrogen sensing capability is as good as that of liquid leak detectors. Obviously, you cannot use this device to test air lines for leaks.

Testing for Leaks

Caution: Always wear eye protection and gloves when opening or closing cylinders. Do not stand in front of the gauges. Bourdon tubes in pressure gauges can rupture with enough force to cause serious injury.

Note: Bypass or remove purifiers during leak testing.

Open all valves in the line (and in each branch line, in a multiple-GC system), but close the last shutoff valve just before the GC(s). Pressurize the system to 100psig. After a few minutes, when the pressure is stable, close the shutoff valve immediately downstream from the cylinder regulator. You may see an initial pressure drop of a few pounds (it might be necessary to install a pressure gauge after the shutoff valve for this test). If the system then

Figure P. Be Sure to Leak Check All Regulators

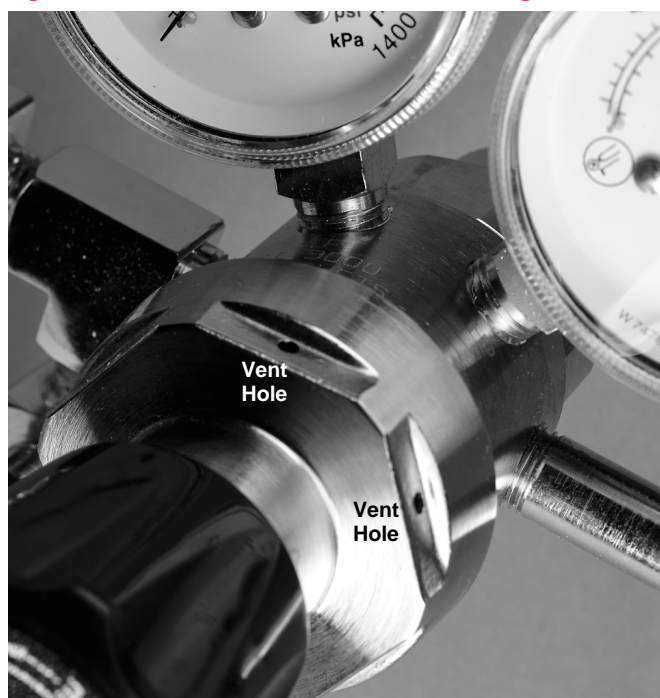

996-0055

maintains pressure for 1/2 hour you have no leaks of any significance. If the pressure continues to drop, you will need to search for leaks (typically it will drop very rapidly if leaks exist). In a multiple-GC system, shutoff valves at each branch and just before each GC enable you to isolate and test sections of the system. This is quicker than testing every fitting, regulator, and valve.

If your system fails the pressure test, and you have been pressure testing with air, vent the air in the section(s) involved and repressurize with helium. Using an electronic leak detecting device, systematically isolate and test each section, starting at one end of the system and working back to the cylinder. If you find a leak, seal it, then pressure test again before proceeding. Test *each* line connection, each valve knob connection, the vent holes of regulators, or anywhere you feel a leak could develop. Don't forget to test connections inside the chromatograph.

Most regulators have a small vent hole on the spring side of the diaphragm (Figure P). If gas is leaking from this site, the diaphragm or an internal seal is bad. If the leak is from the pressure relief port, that part of the regulator may be bad. If the leak is internal to the regulator – a leaking diaphragm, internal seal, or pressure relief vent – replace the regulator. Never attempt to repair or replace any parts other than the CGA fitting. Faulty regulators should be sent to people who are properly trained in regulator maintenance.

If the leak is between the CGA fitting and the regulator the fitting may simply be loose and need tightening. Most CGA fittings have flat surfaces for tightening. Don't overtighten. If the leak persists, unscrew the CGA fitting and be sure there is no dirt on the fitting or cylinder seat. If dirt is not the problem and the leak persists you may need a new CGA fitting, or the seat of the fitting in the cylinder valve may be damaged. If the fitting or the seat is damaged, using Teflon tape on the fitting will not work – the sealing point is at the end of the fitting, not on the threads (Figure B). After you find and seal all leaks it is time to fill the lines with the correct gases.

Purging

Once you have determined that the system is leak free, you are ready to purge the lines and replace the air, nitrogen, or helium test gas in each line with the gas for which the line is intended. The procedure to follow depends on the gas line you are purging. For air and hydrogen being used as detector fuel, use the simple purging procedure for fuel gases described below. Carrier gas lines and make-up gas lines require a more extensive purge to ensure the desired purity level.

Note: In each case, purge the line up to the first purifier, bypass the purifiers, or remove the purifiers during purging. Do not purge the line through the purifiers or the chromatograph.

Simple Purging Procedure for Fuel Gases

Caution: Be sure to properly vent hydrogen during this stage. Trained personnel should be present, testing with a portable low explosive level meter, to ensure that you do not create explosive concentrations of hydrogen.

Open all valves in the main and branch gas lines. Slowly open the valve on the cylinder, pressurizing the two-stage regulator. Slowly open the downstream pressure control knob on the regulator, to allow gas to flow through the lines at a pressure of 5-10psig. Purge the lines for 5 minutes, then close the shutoff valves at the vent ends of the lines. This may involve several points if you have a manifold system with several branches – start at the branch closest to the cylinder and work out. Now turn off the cylinder and isolate it by closing the shutoff valve downstream from the two-stage regulator.

The line is now purged, pressurized, and ready for use. Increase the pressure in the line to the desired operating pressure (e.g., 40-60psig).

Purging Carrier and Make-up Gases

Carrier gas and make-up gas systems require a static purge, followed by a dynamic purge, to ensure the desired purity levels.

Static Purge: Open all valves in the main and branch gas lines, but close the shutoff valves at the vent ends of the lines. Slowly open the valve on the cylinder, pressurizing the two-stage regulator. Slowly open the downstream pressure control knob on the regulator, allowing gas to flow through the lines. Raise the main line pressure to the pressure you intend to maintain (typically 60-100psig) Close the downstream pressure control valve on the two-stage regulator as soon as the pressure is reached. Hold the system under pressure for 15 minutes, then allow a very small flow to escape from the shutoff valves at the vent ends of the lines. The pressure will drop quickly. Close the shutoff valves just before the pressure reaches zero. It is important that this step not take too long, or air could leak back into the system. Repeat this step 10 times. This allows impurities trapped in sections of the line which never get properly swept with gas to diffuse/desorb into the static purge gas.

Dynamic Purge: After the last static purge, close the shutoff valves at the vent ends of the lines and bring the main line pressure to 20psig. Choose a shutoff valve as far downstream from the cylinder as possible. Open this valve slightly, then adjust the valve to allow a 60cc/min flow of gas. Purge for 24 hours. For this step an extra flow controller, installed after the opened shutoff valve, will make it easy to regulate the flow and will help to minimize back diffusion into the line.

Purifier Connections

After all gas lines are purged it is time to install and purge the purifiers you will be using. Most Supelco purifiers are factory sealed with nitrogen or helium and will not contain air. Thus, these devices require only a short purge time before you can operate your system. Other purifiers may require many hours to purge. Read the instructions that accompany the purifiers you intend to use, to be sure you purge them properly.

At this point all system components should be in place. The only part of the system left to purge is the short length of tubing connecting to the chromatograph.

Hereafter, whether the chromatograph is in use or idle, all lines should remain pressurized at all times.

Installations

Gas chromatograph installations range from simple single-chromatograph systems to very complex multi-bench systems. Concerns for a simple installation also are important for the complex multiple instrument system. If you plan to design a complex system, you first should read and understand the information presented for the simpler systems, as well as the basic information in the first sections of this bulletin. In designing any system, take time to consider your future needs. Most plumbing problems develop when a change is made to an existing system. It is good practice to install your GC with valving and bypass fittings which will quickly allow you to add one or more GCs. Regardless of how many GCs are involved the operation, addition, or removal of any GC from the system should not affect the operation of the other GCs in the system.

Installation: Single GC

Location

One of the first steps should be to select a location for the chromatograph. Site selection is important for many reasons, including efficient functioning of both the chromatograph and the operator. Consider temperature and humidity. Generally, instrument manufacturers ask that the room air temperature be between 20°C and 27°C (68-80°F) and the humidity be between 50% and 60% (with no condensation). Air exchange for the oven is very important to the operation of a GC. The back of the instrument must be clear for at least 1 foot. The GC will be venting hot air from the oven to this area. This cannot be accomplished if the vent from one GC is too close to a wall or the back of another instrument. Don't back instruments against one another, or against other heat sensitive equipment, so that they vent toward each other. Special vent-directing devices can be installed to avoid these problems (consult your chromatograph manufacturer). Similarly, don't place the GC by a window, or directly under air conditioning or other types of vents. Don't place computers, integrators or recorders so that the paper from these devices is exposed to the vents from ovens or can spread over heated devices. This can cause a fire or, at the least, discolor heat-sensitive paper. Ignoring these precautions can cause erratic temperature control, electrical problems, and shorter equipment life. For more specific information, consult your instrument manufacturer.

The operator will need room to store samples, along with syringes and other tools, prior to and after injection. It is best to leave at least a 2 foot by 2 foot working surface for this purpose. The space requirement of the GC will be defined by the instrument model, but in most cases a 3 foot wide space is adequate. Add 2 additional feet for computer controls and other ancillary devices (autosampler controls, purge and trap devices, sample concentrators, etc.). Thus, most GCs and associated devices will require about 6-8 linear feet of counter space. For most labs, this means no more than 3-4 GCs on a 20-24 foot bench.

Gas Cylinders and Gas Lines

Your next decision is to determine where to locate the 1-6 types of gas cylinders or generators you will need to operate your chromatograph. Some facilities prohibit the storage of high pressure cylinders in labs or hallways. Consult your safety department to determine a suitable location for your cylinders.

Ideally you want the cylinders as close to the GC as possible. The shortest length of tubing with the fewest connections is best. Never make a connection in a location that will be hard to access for leak testing (e.g., overhead, in a ceiling, or behind a bench which is against a wall).

The diameter of the gas line between the cylinder and the GC depends on the distance. For a single GC with cylinders within a few feet of the instrument, 1/16" stainless steel or 1/8" copper tubing normally are used. These small diameter lines can only be a few feet long, however, or back pressure will be high (see Table 8). If the cylinders are further away 1/4" tubing typically is used. If the distance is extreme (20 feet or more) 1/2" tubing should be used. Reduce 1/4" or 1/2" main lines to 1/8" or 1/16" tubing immediately before the connection to the chromatograph(s).

As a rule, we suggest using larger bore tubing than a first evaluation would indicate. With larger lines, you have adequate pressure and flow for additional units, and won't have to redo the lines. Allow for expansion and you will save yourself much trouble in the future.

Simple Basic Plumbing For One GC

The diagrams in Figures Q-V show our various alternative recommendations for installing a single GC/FID, using gas cylinders, cylinders and generators, or generators, and using hydrogen as fuel or as fuel and carrier gas. TCDs, ECDs, and other detectors do not require a fuel gas line. Although we recommend gas purifiers as safeguards, the purifiers shown in Figures Q-V can be removed if you do not think you need this additional protection. Similarly, intermediate shutoff valves in the line are useful but not vital. Be aware that simplifying your system by eliminating purifiers, shutoff valves, etc. reduces initial costs, but you pay a higher price in terms of inconvenience (longer downtimes) and loss of column/detector protection.

The single-cylinder installations in Figures Q-S leave you with the problem of having to cool down the GC and slowly depressurize the entire system to change cylinders. Figure V shows a two cylinder approach which can be used for continuous delivery of any gas. When the pressure in one cylinder indicates the cylinder must be changed, the empty cylinder can be closed and the reserve cylinder opened. We recommend this approach. You should immediately take the time to change the empty cylinder, however, or the extra plumbing will be for naught. If you do not change cylinders immediately, chances are good that you will forget to do so, both cylinders will empty, and you will still have to shut down your GC.

A second approach to cylinder changeover also is viable. An automatic changeover regulator system (Figure W) connects two gas cylinders, the active cylinder and a reserve cylinder. When the pressure in the active cylinder falls below a preset level, gas automatically begins to flow from the reserve cylinder. You can change cylinders at your convenience without interrupting the analysis. The changeover regulator system works on a pressure differential. The line pressure from the active cylinder is set about 5psig higher than the pressure from the reserve cylinder. Both cylinders are open, but the reserve cylinder will not deliver gas as long as the active cylinder can deliver gas at a pressure 5psig higher than the pressure from the reserve cylinder. This approach requires two pressure regulators and a downstream in-line regulator, or the GCs will register the change in pressure when the cylinders switch operation.

Installation: 2-4 GCs

When you plan to install a 2-4 GC system you must concern yourself with issues that did not arise with a single GC. Line diameters and connections, types of purification, valving, locations, and electrical needs all become more complicated. The plumbing changes from the relatively simple straight lines of tubing shown in Figures Q-V, to a complicated assortment of valves, fittings, and other components. Figure X shows a true manifold system of three main lines, adequate for 2-4 GCs. For each gas, a two-stage regulator controls gas pressure in the main line and single-stage regulators are used in each branch line. We recommend that the main line pressure be 90-100psig and the individual line regulators be capable of providing up to 75psig (see Figure F). If your cylinders are located more than 20 feet from the bench you should use 1/2" main lines.

Notice that there is a shutoff valve after each branch-off from the main line. We recommend installing these valves, if your budget allows, because they enable you to pressure test individual sections of the system, or isolate each GC and take it off-line without affecting the operation of the other GCs. The system also

Figure Q. Ideal Configuration for a Single-GC System: Gas Delivered from Cylinders

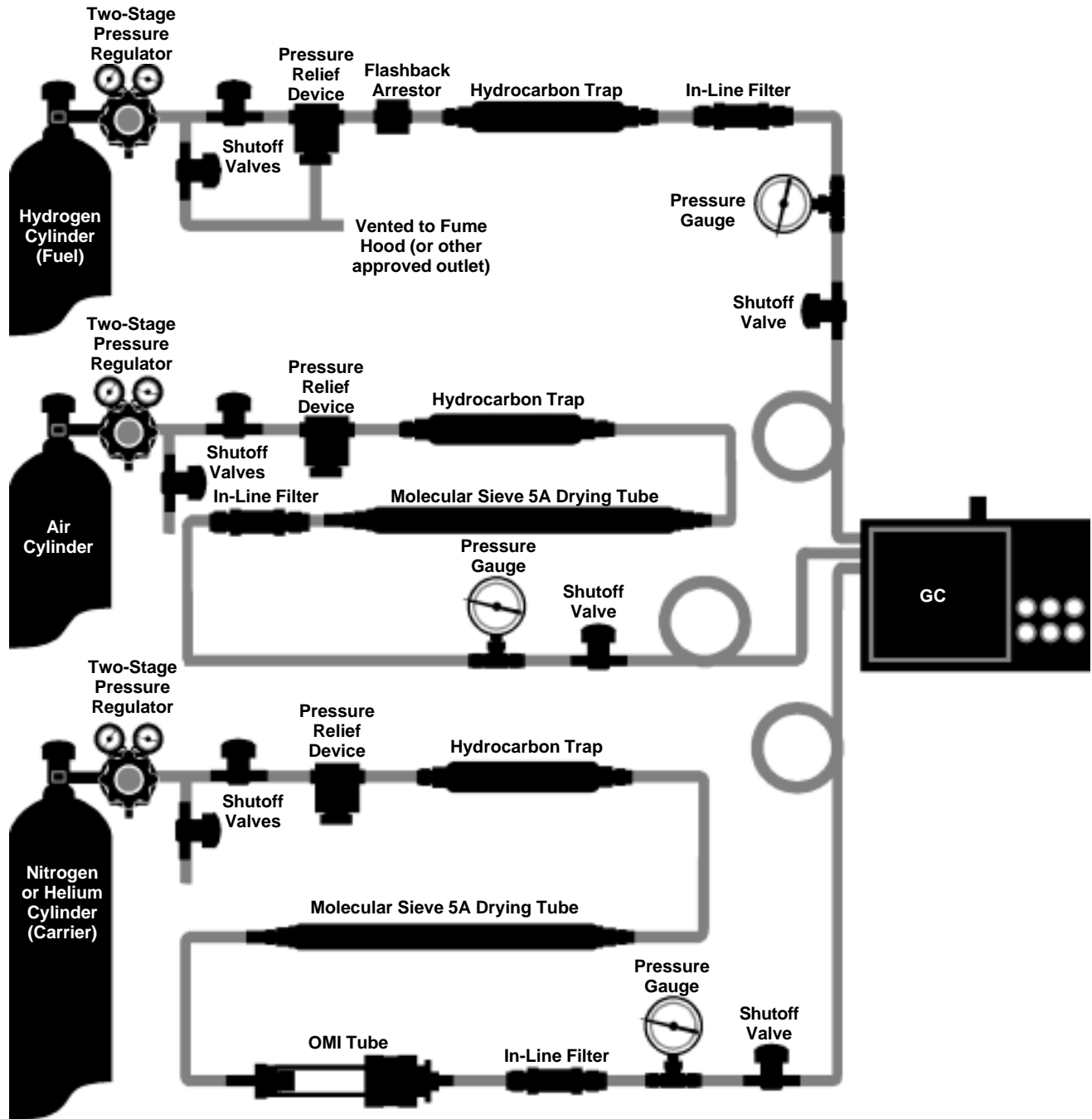

796-0069

has in-line pressure gauges after the two-stage regulators, to indicate the pressure in the main lines.

In a multiple instrument system, carrier gas and make-up gas purification also becomes more important. If you have only one GC, you might not need gas purification, but with all the additional connections, regulators, and other devices in a system with up to 4 GCs you almost certainly will need several types of purifiers.

Consider the total environment of your multi-GC installation. With all the integrator and detector cables, gas lines, and electrical power lines, you will need to allow easy access and identification, and consider interference with electrical signals. Allow access room at the front and back of each instrument.

Most commercial laboratory benches are deep enough to install GCs on both sides, but we recommend splitting the bench, creating a central access space (not a walkway) to allow access to the back of each GC. Always stagger the instruments on the bench, so that heated air from one instrument is not vented directly at another instrument.

Gas and electric lines should not be left to dangle, this can cause safety problems and confusion over what gas a line contains. Various mounting devices are available for gas and power lines, and these devices should be used. We recommend labels and color coding for the gas lines. Neatness does count.

Figure R. Ideal Configurations for a Single-GC System: Mixed Gas Generator/Gas Cylinder System

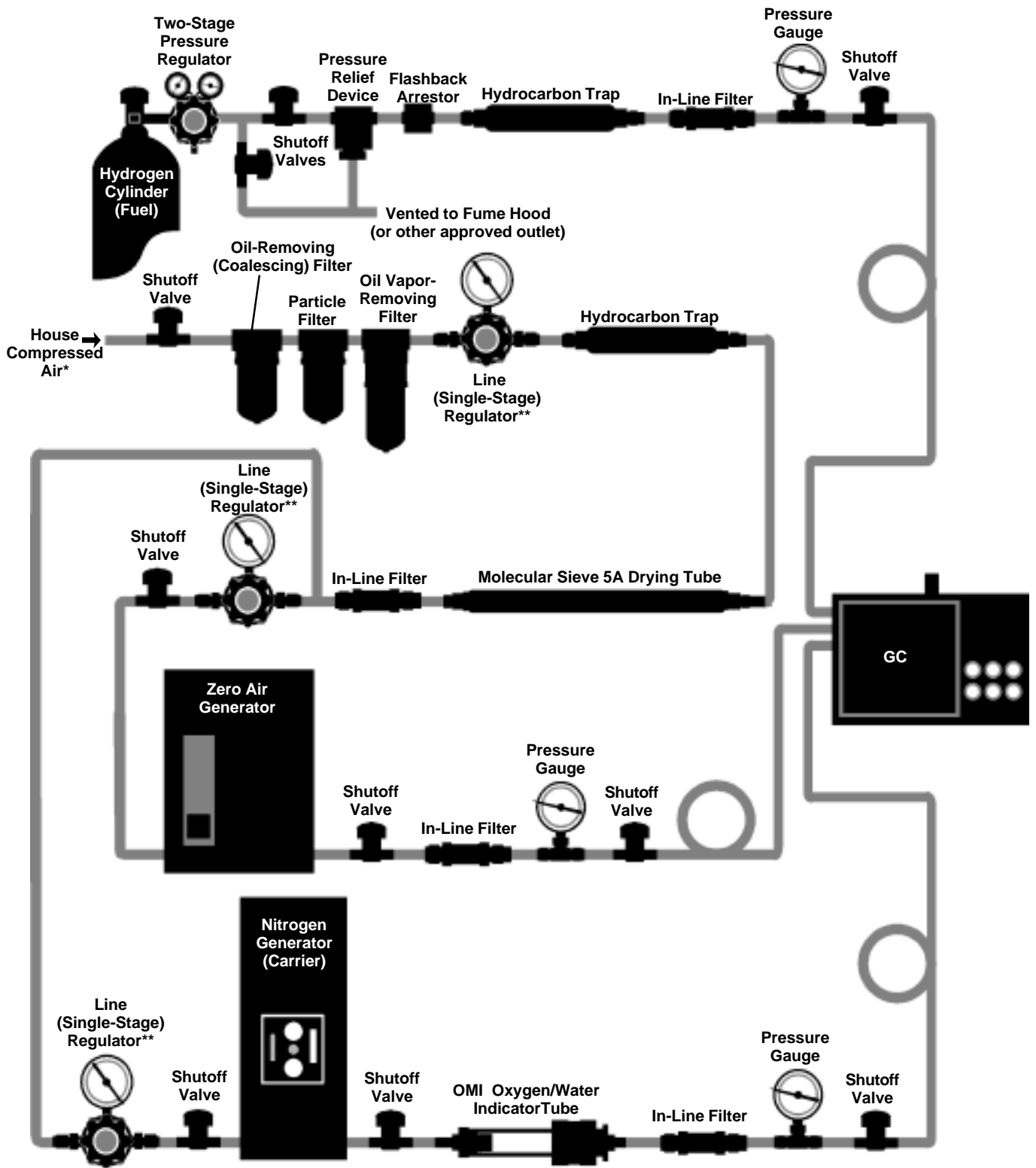

796-0070

*Replace an oil-sealed compressor with an oilless unit to eliminate the need for the particle filter, oil-removing/coalescing filter, and oil vapor-removing filter.
 **Consult generator manual for correct inlet pressure.

Figure S. Ideal Configurations for a Single-GC System: Hydrogen Used as Carrier and Fuel Gas

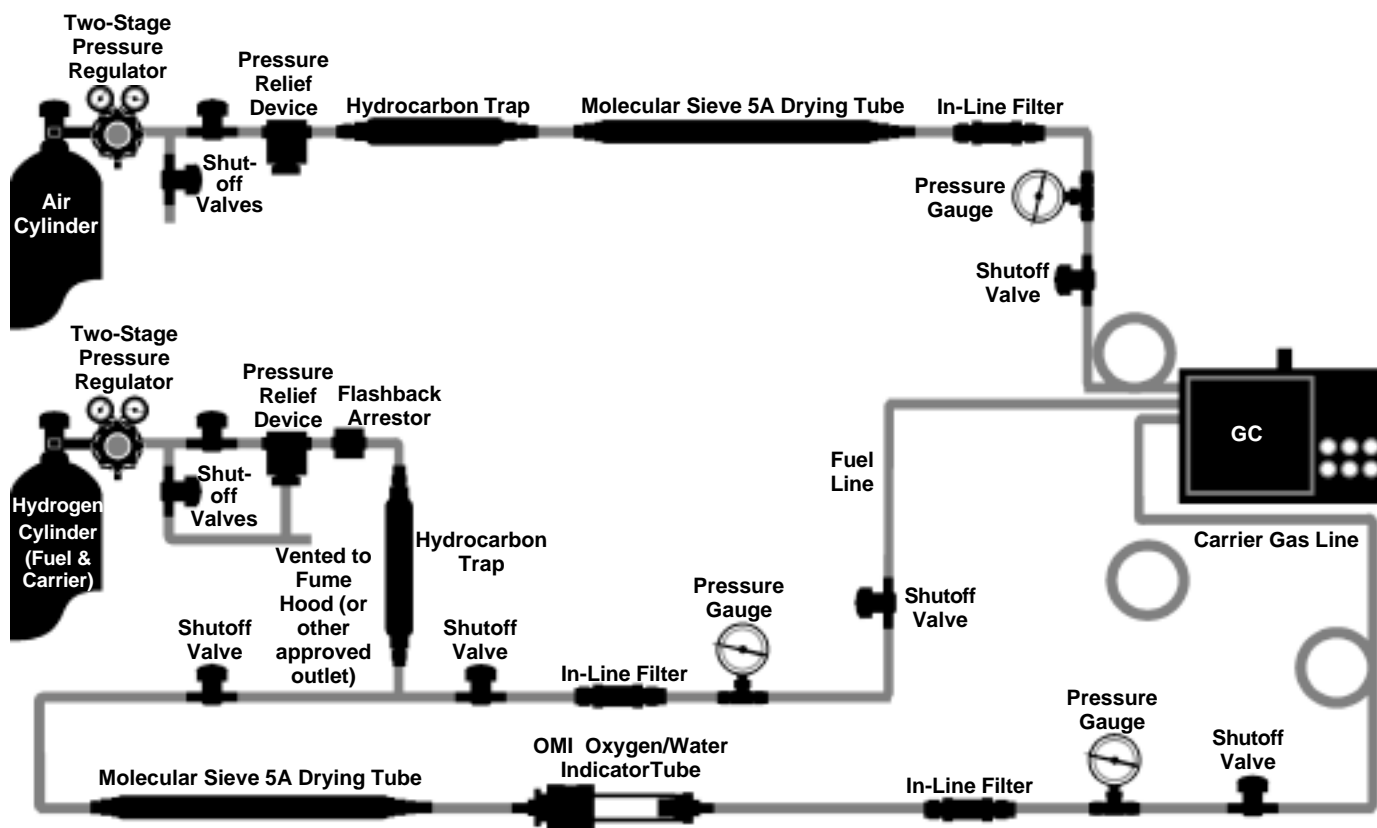

796-0071

Gas Cylinders or Gas Generators?

With up to 4 GCs you will need many gas cylinders. Carefully select the site for the cylinders. To keep the instruments running without interruption, you will not want to shut down instruments to change cylinders. Thus, additional plumbing (i.e., a two-cylinder system or an automatic changeover system, as shown in Figures V and W) will be needed. Furthermore, cylinder changes more frequent than once per week are an inefficient use of manpower. Calculate your gas consumption from the equation and example given in the installation information for 5-20 GC systems. If you will be changing cylinders more frequently than once per week, consider using larger cylinders, cradles of cylinders, or gas generators. Cylinder cradles can be plumbed by your supplier for a single connection to your system. The location of labs in the centers of buildings often forces the cylinders-or-generators issue – generators eliminate the need for very long gas lines or cylinders mounted in hallways. If you decide to use generators, allow bench or wall space for them, as near the GCs as possible.

Electrical Concerns

Electrical requirements for installing 2-4 GCs are similar to those for one GC. Each instrument should be on its own 15-20 amp circuit. Try to keep related electrical devices (integrator, computer, etc.), except electrically actuated devices, on the same circuit. Detector and integrator cables should be shielded and located 6" or more away from the electrical lines. The gas lines, particularly copper lines, should be 6-12" away from the power lines – they can pick up electrical current if they are too close to the power lines.

Of real concern are power interruptions that allow heated zones in the GCs to cool down. When the power is restored, these heated zones all come on together and have a tremendous power draw. When electricity goes off it is best to turn off the main power switch for each GC. When the electricity comes back on, turn each GC back on by zones: detector heaters, then the inlet, then the oven. Consult an electrician about your power needs. Don't forget to establish separate earth grounding for your lines.

Figure T. Ideal Configurations for a Single-GC System: All Generator System

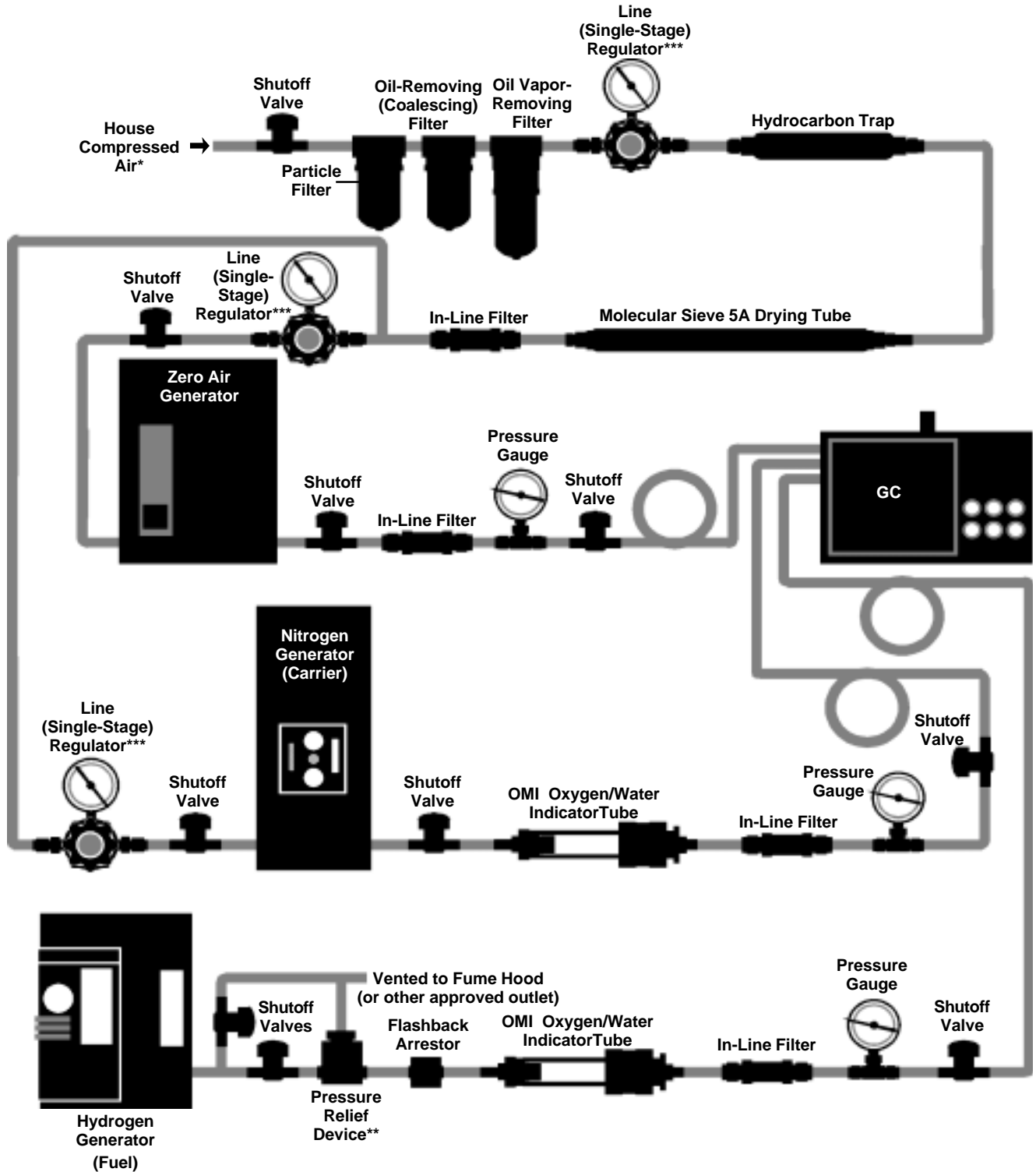

796-0072

*Replace an oil-sealed compressor with an oilless unit to eliminate the need for the particle filter, oil-removing/coalescing filter, and oil vapor-removing filter.

**Not needed if the hydrogen generator has a built-in relief device.

***Consult generator manual for correct inlet pressure.

**Figure U. Ideal Configurations for a Single-GC System:
All Generator System with Hydrogen as Carrier and Fuel Gas**

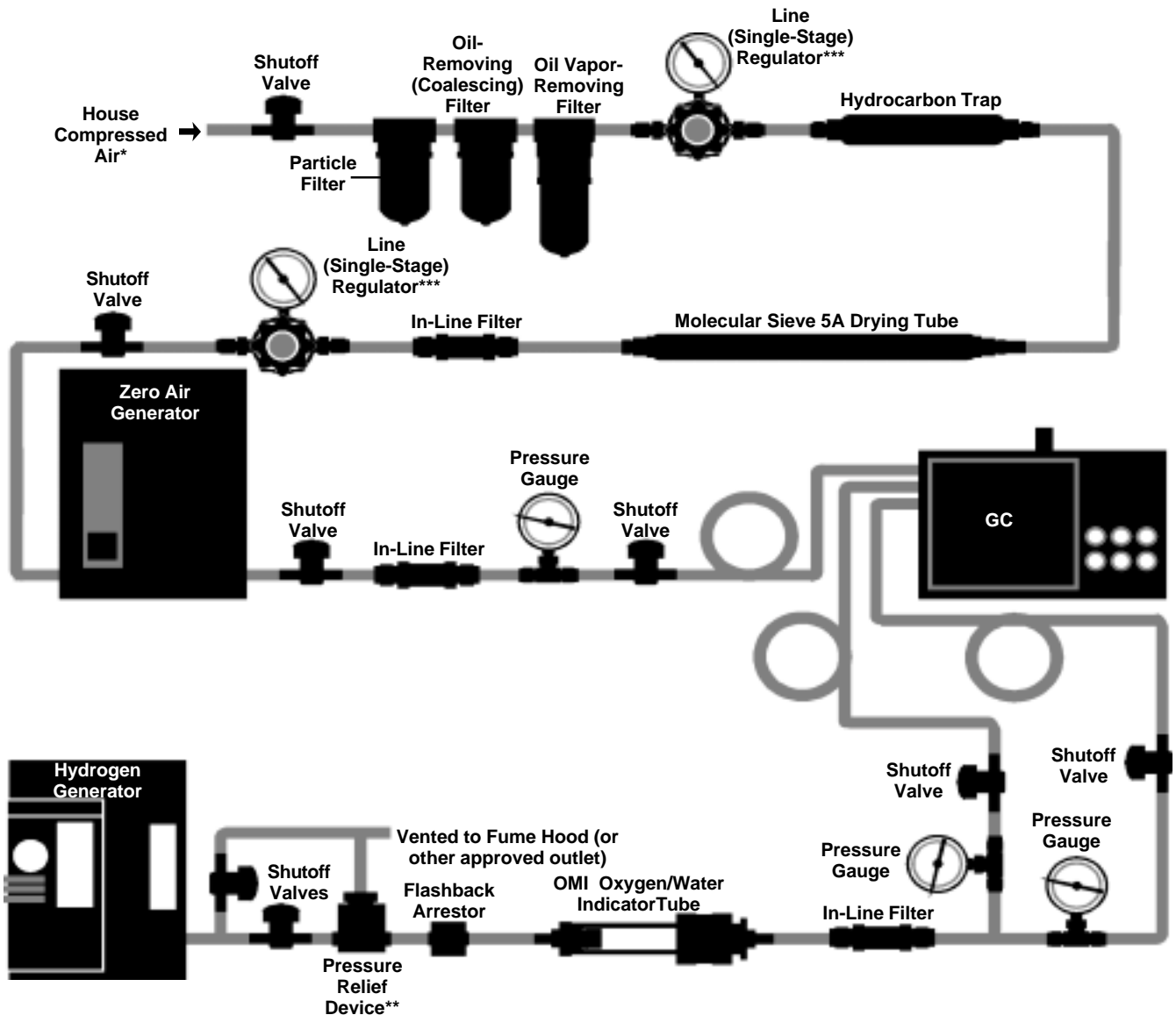

796-0073

*Replace an oil-sealed compressor with an oilless unit to eliminate the need for the particle filter, oil-removing/coalescing filter, and oil vapor-removing filter.

**Not needed if the hydrogen generator has a built-in relief device.

***Consult generator manual for correct inlet pressure.

Figure V. System Using Two Cylinders for Each Gas

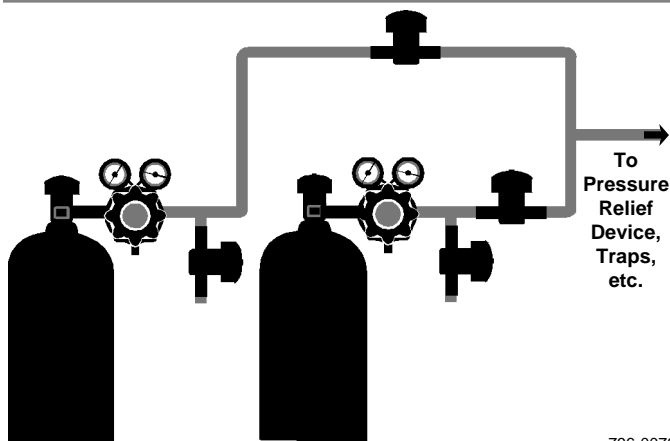

796-0079

Figure W. Automatic Switchover Manifold System

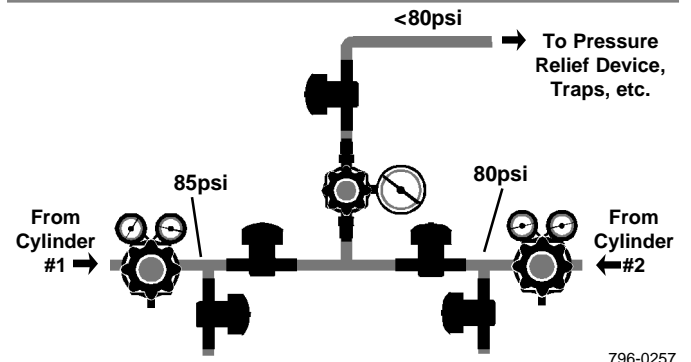

796-0257

Figure X. Ideal Configuration for 2-4 GC System (Plumb gas generators as shown in Figure Q)

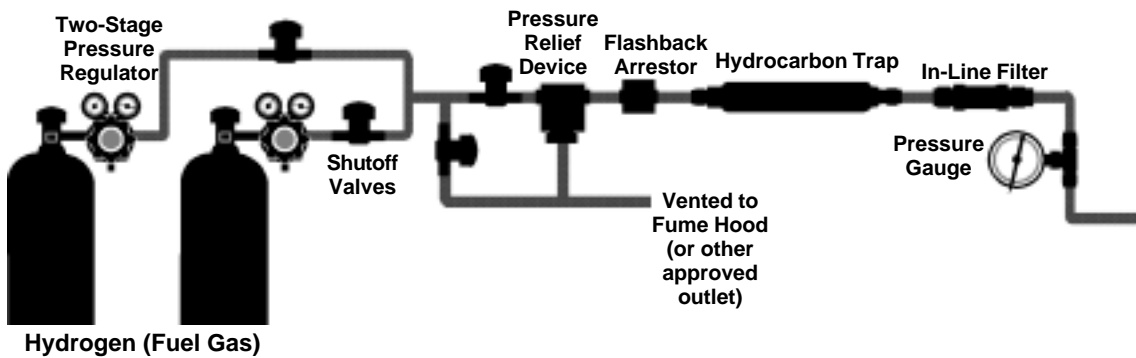
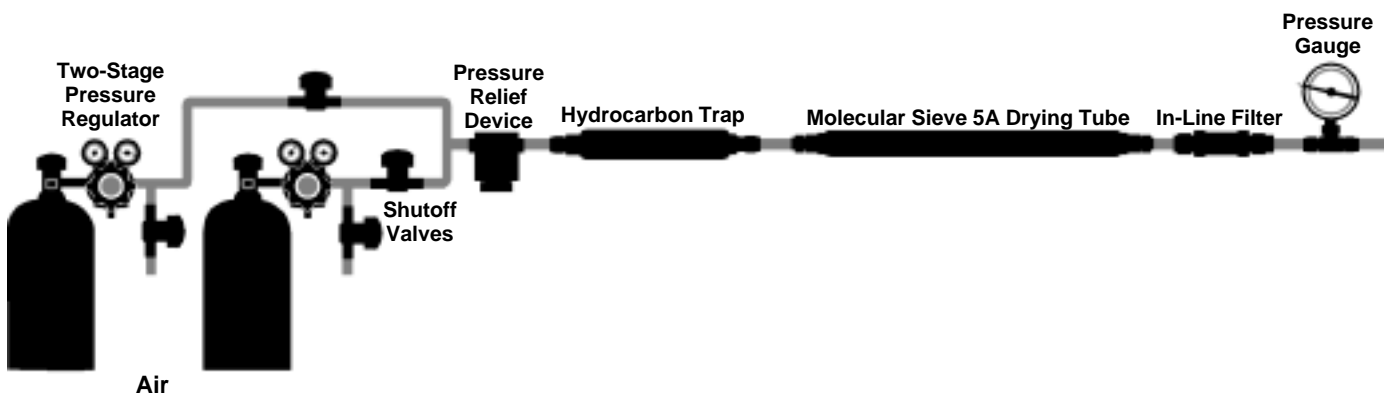
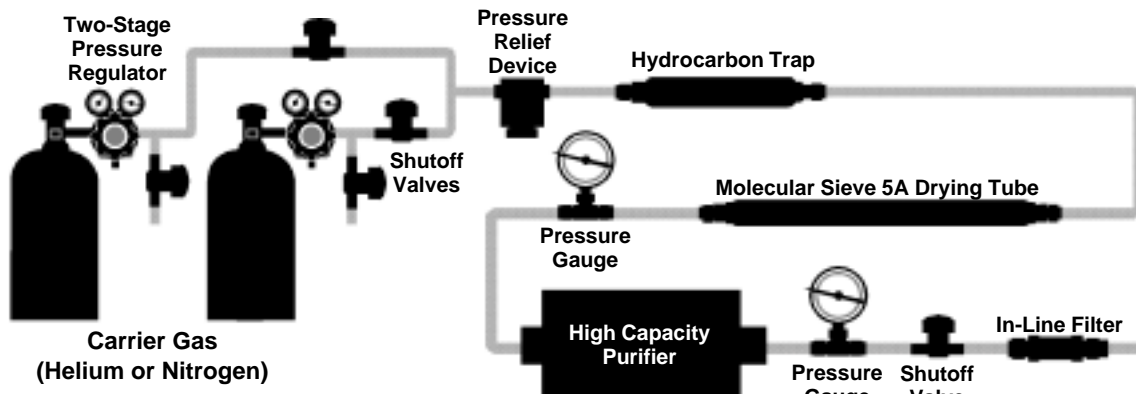

Figure X. (contd.)

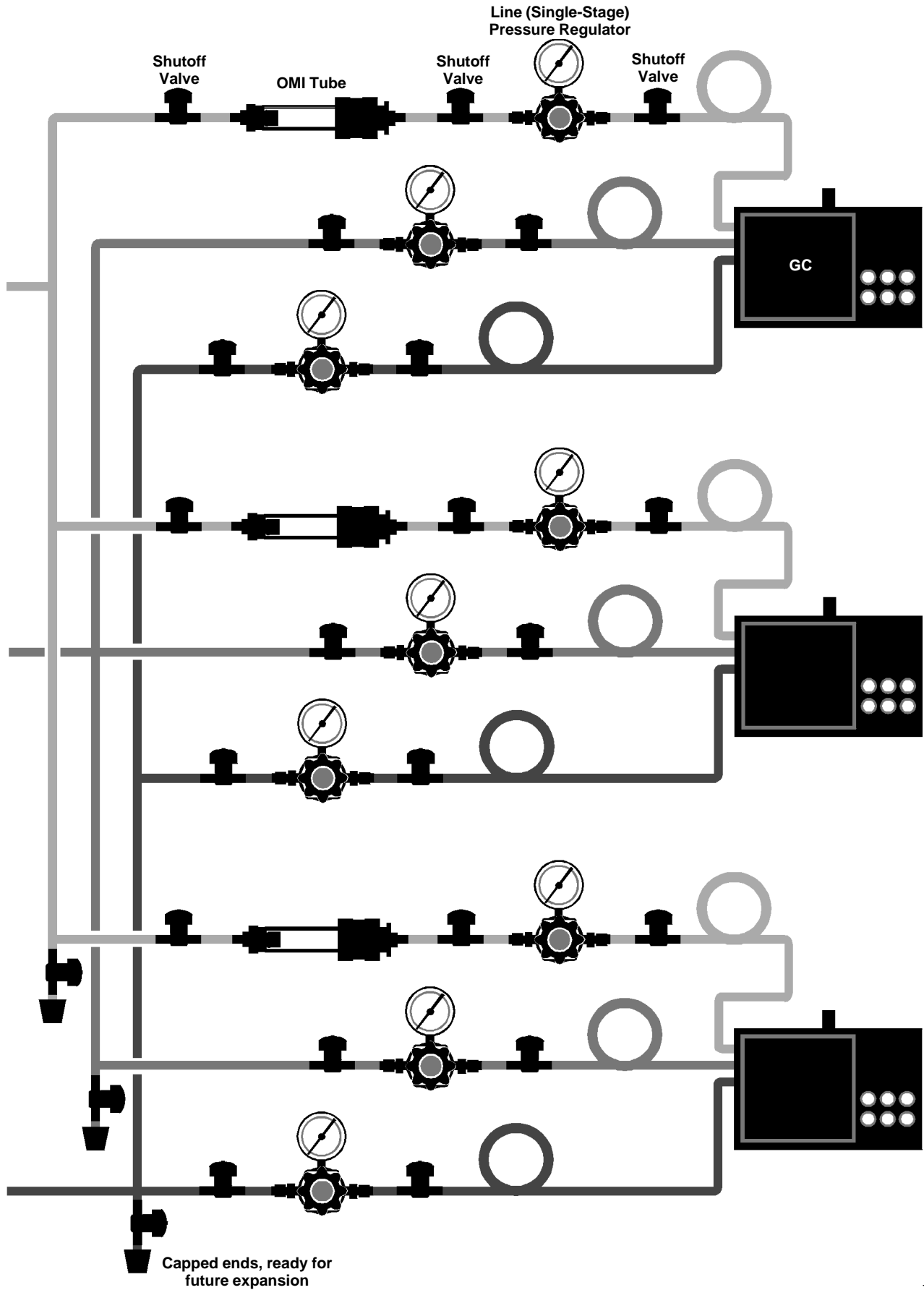
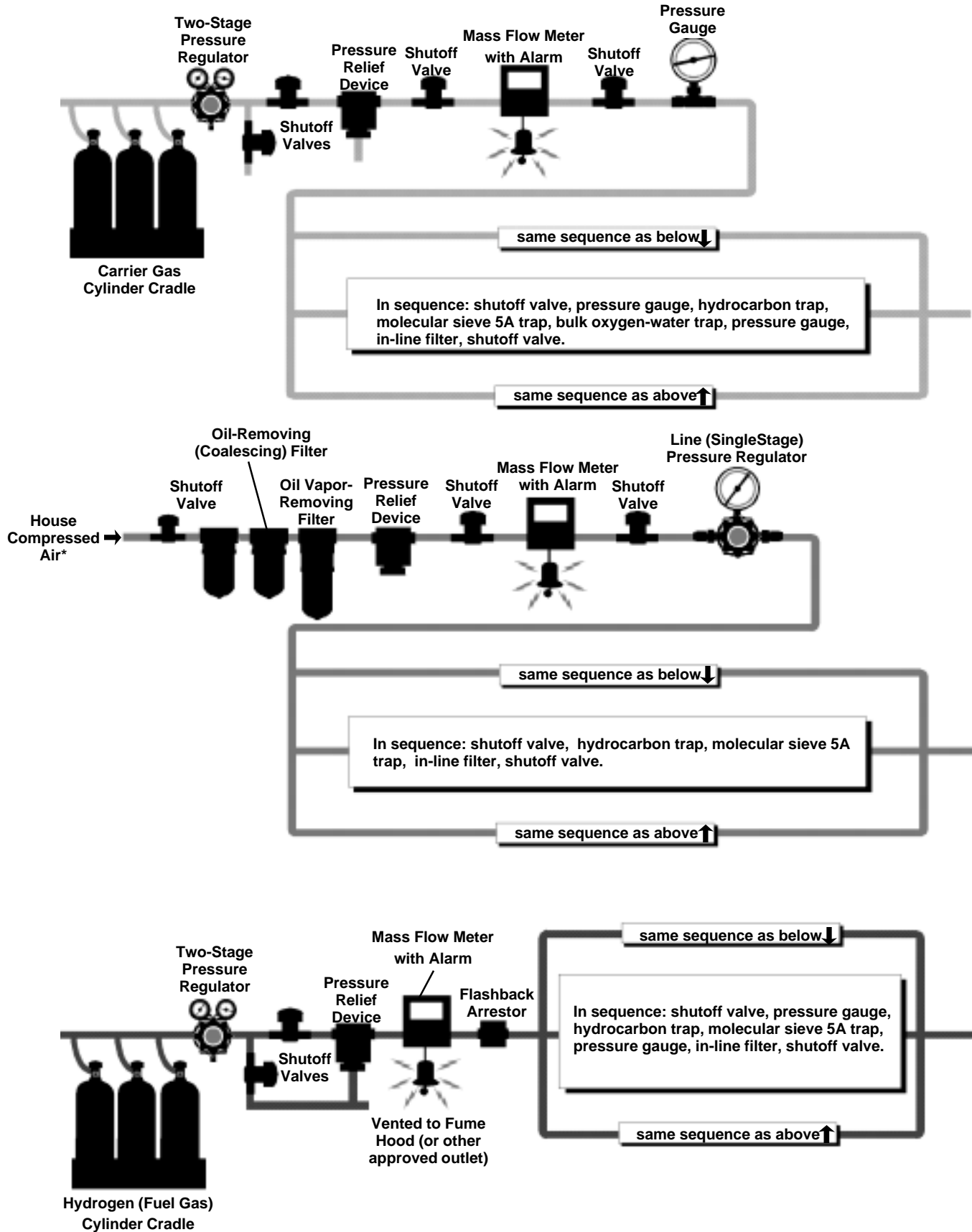

Figure Y. Complex System in a QA Lab



796-0272

*Replace an oil-sealed compressor with an oilless unit to eliminate the need for the particle filter, oil-removing/coalescing filter, and oil vapor-removing filter.

Figure Y. (contd.)

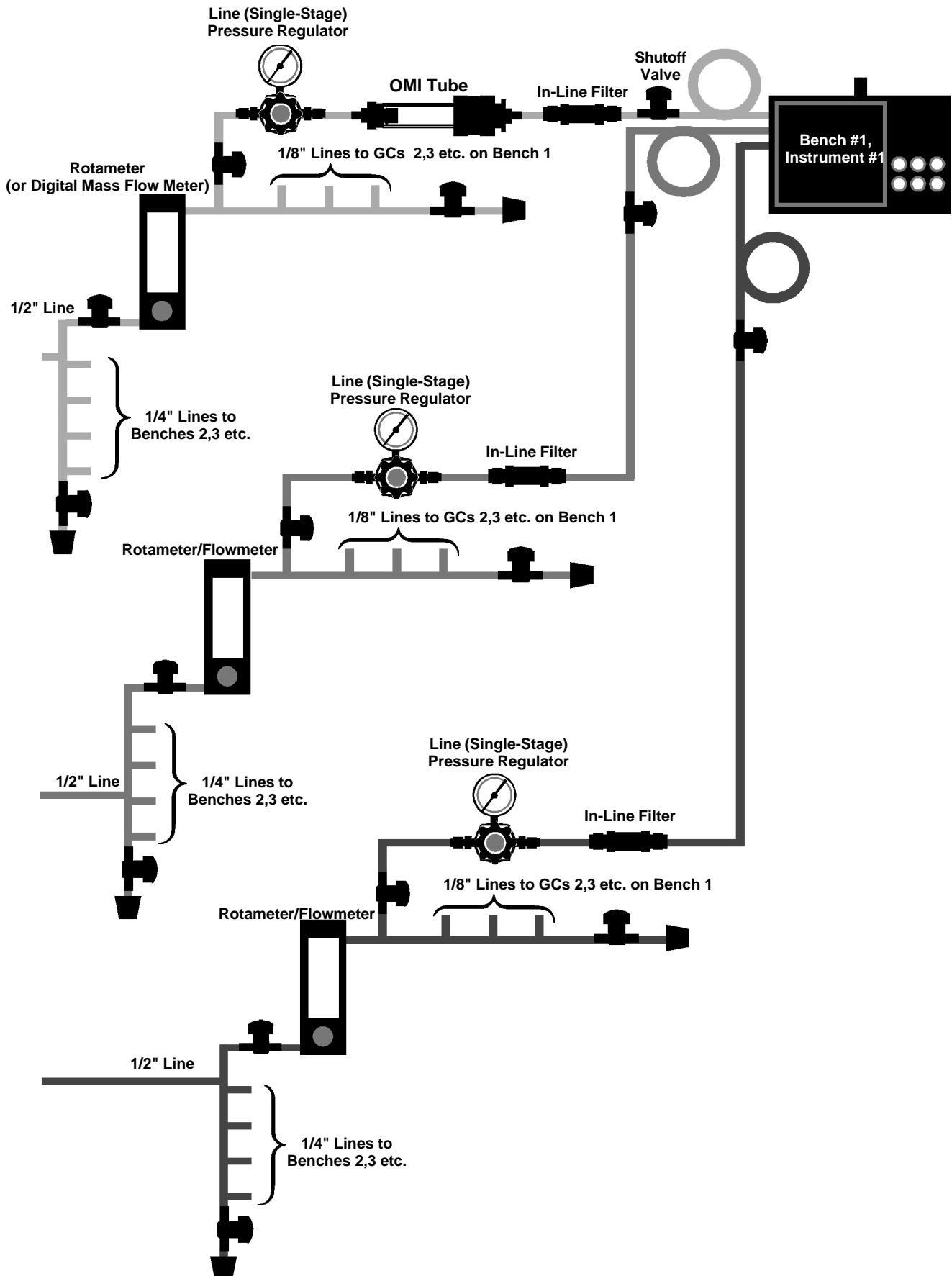

Installation: 5-20 GCs

The additional major concerns for installing a laboratory of GCs deal with gas line diameters, gas flow measurement, and upsizing devices. First, you need to know how much gas the facility might use. Consider that each GC with two flame-type detectors could use the amounts of gases listed in Table 2. Add the gas flows for all the GCs to obtain an estimate of the total gas use. After converting the volume from cc/min to standard cubic feet (SCF) per day, divide the volume of gas in one cylinder by the consumption per day. From this calculation you can determine how long each cylinder should last. Determine this consumption for each of the gases you intend to use.

$$\begin{array}{r} \text{number} \\ \text{of GCs} \end{array} \times \begin{array}{r} \text{mean} \\ \text{flow} \\ \text{(cc/min)} \end{array} \times \begin{array}{r} \text{min/day} \\ (60 \times 24 = 1440) \end{array} = \text{SCF/day}$$

$$\begin{array}{r} 28,317\text{cc/cubic foot} \\ \text{SCF/cylinder}^* \end{array} = \text{days/cylinder}$$

$$\begin{array}{r} \text{SCF/day} \end{array}$$

Example: nitrogen consumption for 5 GCs using 266cc nitrogen/min/GC

$$\begin{array}{r} 5 \text{ GCs} \times 266\text{cc/min} \times 1440 \text{ min} \\ 28,317\text{cc/cubic foot} \end{array} = 67.6 \text{ SCF/day}$$

$$\begin{array}{r} 218 \text{ SCF/cylinder}^* \\ 67.6 \text{ SCF/day} \end{array} = 3.2 \text{ days/cylinder}$$

*Ask your supplier for specifications for the cylinders you use.

Rotameters

In many large-scale GC installations rotameters are used as visual indicators of gas usage. If the rotameter is of the proper size, so that gas use per bench suspends the float or ball mid-way in the rotameter tube, a quick glance will tell you if you are using the correct amount of gas. Leaks tend to push the float off scale – they can easily double or more your gas consumption. We recommend one rotameter for the entire lab and one for each bench (Figure Y).

Mass flow meters also are used in large facilities, to determine the total flow of gas into the facility. Often these devices provide an alarm if the flow is too high. A high flow might indicate a break somewhere in the lines. The use of rotameters and mass flow meters to monitor gas consumption can give very good information about the integrity of the gas systems, and can help you to quickly find leaks.

Gas Purifiers

With high gas usage you can consume these devices rapidly. It might be necessary to mount several purifiers in parallel, to obtain reasonable life from the individual purifiers (Figure Y). Establish a maintenance program for regularly changing these purifiers.

A more practical approach is to use larger purifiers. Hydrocarbon traps and molecular sieve-containing moisture traps with 750cc adsorbent beds – three to five or more times the capacity of conventional traps – are available from Supelco. The ¼” or ½” endfittings on these large traps are compatible with the larger diameter gas lines used in 5-20 GC systems, minimizing the pressure drop across the traps. Our large-capacity traps effectively remove contaminants at flow rates of up to 10 liters/minute.

Electrical Considerations

Consult an electrical engineer about the special needs of a large GC facility. Explain the need for separate, dedicated, grounded lines for each GC and associated equipment. As when designing simpler systems, estimate your total power needs by adding approximately 2100 watts for each GC, and the needs of the integrators and all peripheral equipment which you anticipate using.

Additional Resources

From the foregoing information, you can appreciate that there is latitude in many aspects of installing a gas chromatograph. Detailed information about in-line gas purifiers is presented in our Bulletin 848, which is available on request. Specifications and information about hydrogen generators, nitrogen generators, and zero air generators are presented in publications 694001, 413065, and 494053, respectively. The Swagelok Manual (Catalog No. 22339) contains much detailed information about plumbing gas systems.

As you can appreciate, the information in this bulletin is general in nature. What is best in most situations may not apply to your specific situation. If you are unsure about something, it is always best to ask before proceeding. Supelco technical service and research chemists are always available to discuss your concerns.

Trademarks

Crescent – Cooper Industries
Drierite – Hammond, W.A., Drierite Company
GateKeeper – Aeronex, Inc.
Glasrench, OMI, Supelcarb, Supelpure – Sigma-Aldrich Co.
GOW-MAC – GOW-MAC Instrument Co.
Hall – Tracor Instruments, Austin, Inc.
Imp – Gould, Inc., Valve & Fittings Div.
Leak-Tec – American Gas & Chemical Co., Ltd.
MAPP – Dow Chemical Co.
Nanochem – Matheson Gas Products
Nupro, Snoop – Nupro Co.
Oxiclear, Oxisorb – MG Industries
Swagelok – Crawford Fitting Co.
Teflon – E.I. du Pont de Nemours & Co., Inc.
Viton – DuPont Dow Elastomers
Whitey – Whitey Co.

For more information, or current prices, contact your nearest Supelco subsidiary listed below. To obtain further contact information, visit our website (www.sigma-aldrich.com), see the Supelco catalog, or contact Supelco, Bellefonte, PA 16823-0048 USA.

ARGENTINA - Sigma-Aldrich de Argentina, S.A. - Buenos Aires 1119 **AUSTRALIA** - Sigma-Aldrich Pty. Ltd. - Castle Hill NSW 2154 **AUSTRIA** - Sigma-Aldrich Handels GmbH - A-1110 Wien
BELGIUM - Sigma-Aldrich N.V./S.A. - B-2880 Bornem **BRAZIL** - Sigma-Aldrich Quimica Brasil Ltda. - 01239-010 São Paulo, SP **CANADA** - Sigma-Aldrich Canada, Ltd. - 2149 Winston Park Dr., Oakville, ON L6H 6J8
CZECH REPUBLIC - Sigma-Aldrich s.r.o. - 186 00 Praha 8 **DENMARK** - Sigma-Aldrich Denmark A/S - DK-2665 Vallensbaek Strand **FINLAND** - Sigma-Aldrich Finland/YA-Kemia Oy - FIN-00700 Helsinki
FRANCE - Sigma-Aldrich Chimie - 38297 Saint-Quentin-Fallavier Cedex **GERMANY** - Sigma-Aldrich Chemie GmbH - D-82041 Deisenhofen **GREECE** - Sigma-Aldrich (o.m.) Ltd. - Ilioupoli 16346, Athens
HUNGARY - Sigma-Aldrich Kft. - H-1067 Budapest **INDIA** - Sigma-Aldrich Co. - Bangalore 560 048 **IRELAND** - Sigma-Aldrich Ireland Ltd. - Dublin 24 **ISRAEL** - Sigma Israel Chemicals Ltd. - Rehovot 76100
ITALY - Sigma-Aldrich s.r.l. - 20151 Milano **JAPAN** - Sigma-Aldrich Japan K.K. - Chuo-ku, Tokyo 103 **KOREA** - Sigma-Aldrich Korea - Seoul **MALAYSIA** - Sigma-Aldrich (M) Sdn. Bhd. - 58200 Kuala Lumpur
MEXICO - Sigma-Aldrich Quimica S.A. de C.V. - 50200 Toluca **NETHERLANDS** - Sigma-Aldrich Chemie BV - 3330 AA Zwijndrecht **NORWAY** - Sigma-Aldrich Norway - Torshov - N-0401 Oslo
POLAND - Sigma-Aldrich Sp. z o.o. - 61-663 Poznań **PORTUGAL** - Sigma-Aldrich Quimica, S.A. - Sintra 2710 **RUSSIA** - Sigma-Aldrich Russia - Moscow 103062 **SINGAPORE** - Sigma-Aldrich Pte. Ltd.
SOUTH AFRICA - Sigma-Aldrich (pty) Ltd. - Jet Park 1459 **SPAIN** - Sigma-Aldrich Quimica, S.A. - 28100 Alcobendas, Madrid **SWEDEN** - Sigma-Aldrich Sweden AB - 135 70 Stockholm
SWITZERLAND - Supelco - CH-9471 Buchs **UNITED KINGDOM** - Sigma-Aldrich Company Ltd. - Poole, Dorset BH12 4QH
UNITED STATES - Supelco - Supelco Park - Bellefonte, PA 16823-0048 - Phone 800-247-6628 or 814-359-3441 - Fax 800-447-3044 or 814-359-3044 - email: supelco@sial.com

H

Supelco is a member of the Sigma-Aldrich family. Supelco products are sold through Sigma-Aldrich, Inc. Sigma-Aldrich warrants that its products conform to the information contained in this and other Sigma-Aldrich publications. Purchaser must determine the suitability of the product for a particular use. Additional terms and conditions may apply. Please see the reverse side of the invoice or packing slip.