

# A Fast, Unified Analysis of Key Components in Bio-Ethanol Fuels Using Heart-Cutting Multi-Dimensional Gas Chromatography (K.19)

James D. McCurry, Agilent Technologies, Wilmington DE, USA



## Introduction

Ethanol fuels made from renewable biomass are finding markets throughout the world as producers scale up production and automobile manufacturers develop ethanol capable vehicles. The key feedstock for these fuels is denatured fuel ethanol, composed of 92 to 98 percent ethanol denatured with hydrocarbons. Final commercial fuels contain 20 to 85 percent ethanol with the a balance of natural gasoline. To meet engine requirements and environmental regulations, both the denatured ethanol and the various ethanol/gasoline blends must meet key specifications in regards to the content of ethanol, methanol, benzene and toluene. Industry consensus organizations such as ASTM have specified two GC methods to measure these components, D5501 and D5580. These methods require two instruments with specific column and valve configurations resulting in long analysis times. Multidimensional capillary column GC (MDGC) offers the possibility of combining several individual measurements into a single run. Additionally, using short, orthogonal columns a MDGC separation is often faster than with a single long capillary column. As applied to a simple analysis of denatured ethanol, this concept was demonstrated by the author using a Deans switch system in 2003.[1] This poster presents a MDGC system for the analysis of key components in several fuel ethanol blends as an alternative to two different ASTM methods. Analysis times were reduced from several hours to less than 15 minutes. The use of back flush techniques was combined with this MDGC analysis to further reduce run times as well as extend column life. Results were consistent with those found using the standard ASTM methods.

1. "Fast Determination of Fuel Ethanol Purity by Two-Dimensional Gas Chromatography", James D. McCurry, Agilent Technologies Application Note, Publication Number 5988-9460EN, April, 2003.

## ASTM GC Methods for Ethanol Fuel Analysis

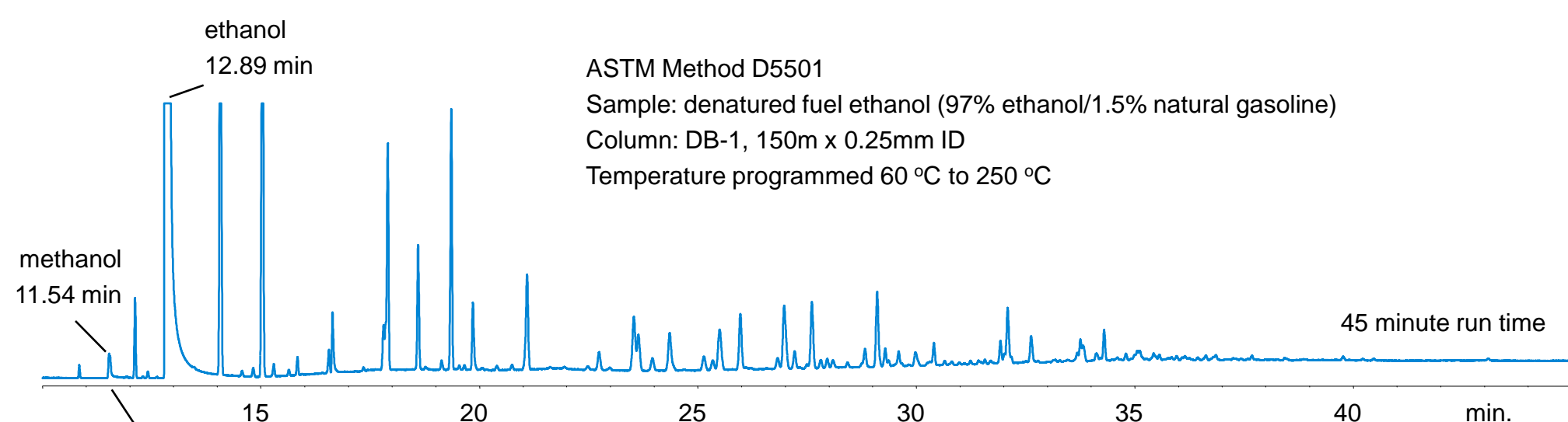

ASTM Method D5501  
Sample: denatured fuel ethanol (97% ethanol/1.5% natural gasoline)  
Column: DB-1, 150m x 0.25mm ID  
Temperature programmed 60 °C to 250 °C

ASTM method D5501 is designed to measure ethanol and methanol in ethanol fuels. A 150-meter PDMS column is needed to resolve the alcohols from the light hydrocarbons. An oven temperature program is also used to elute the heavy hydrocarbons from this column. This method has two drawbacks. First the analysis time is quite long. Second, the column flows and GC conditions must be carefully optimized to achieve only marginal separation of methanol from isobutane.

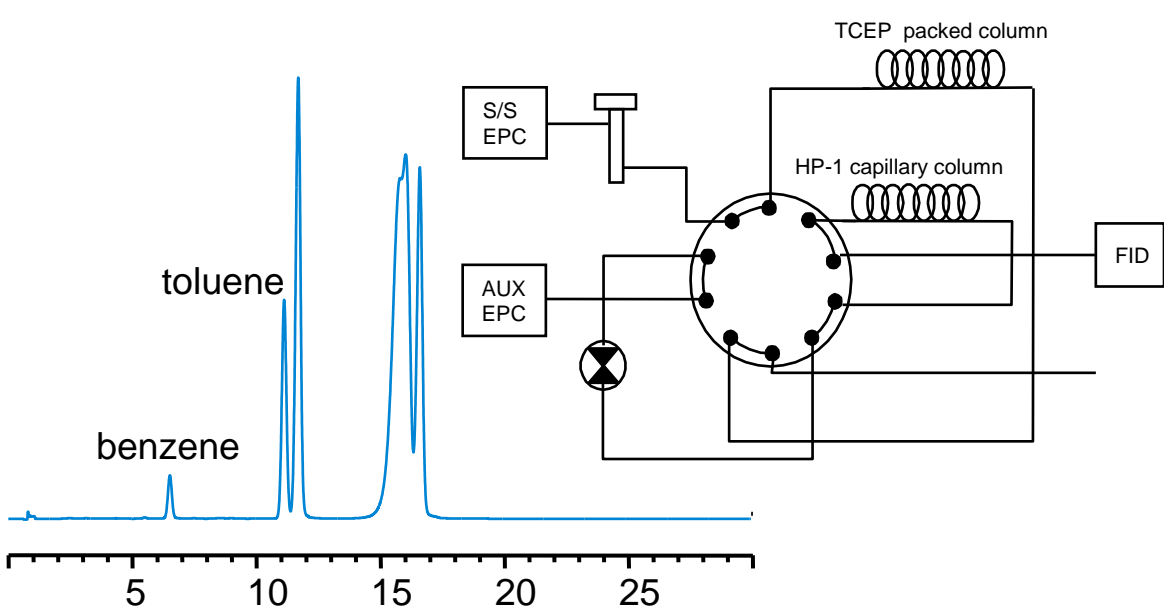

ASTM method D5580 is specified for the measurement of benzene in ethanol fuels. This method uses a 12-port valve and a two columns to separate benzene from the ethanol and hydrocarbons in the sample. While this method works quite well, it does require a lab to have another GC to completely measure key components in ethanol fuels.

## Improvements Using Heart-Cutting Multi-Dimensional GC

Capillary Flow Technology Deans Switch

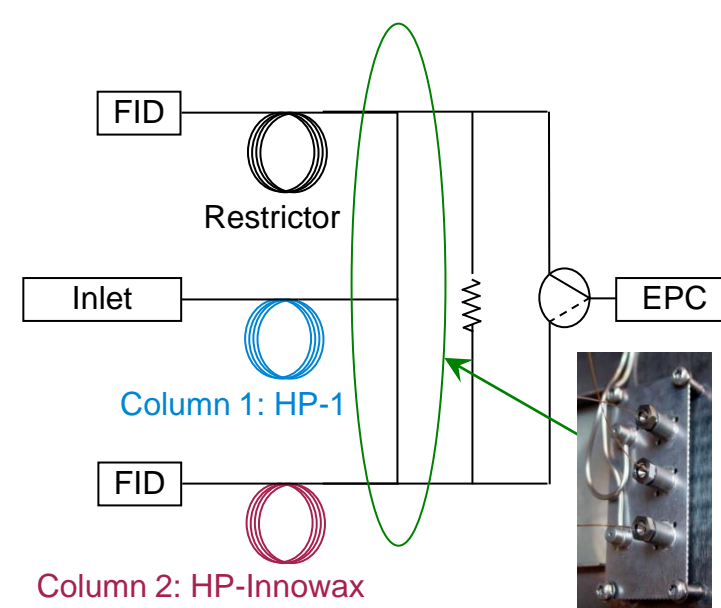

Instrument Conditions for MDGC

Column and Oven Temperature	
Column 1	HP-1, 15m x 0.25mm x 0.25 um
Column 1 flow	Helium at 1.0 mL/min
Column 2	HP-Innowax, 15m x 0.25mm x 0.25um
Column 2 flow	Helium at 2.0 mL/min
Oven Temp	45 °C isothermal
Split/Splitless Inlet	
Split ratio	200:1
Temp	250 °C
Injection size	0.5 uL
Dual Flame Ionization Detectors	
Temp	300 °C and 260 °C

Heart-Cutting Multidimensional GC (MDGC) was used to speed the analysis of ethanol fuels. Two 15-meter columns of different polarity were installed in the Deans switch as shown above. The overall cycle time for the analysis was also improved by using isothermal column oven conditions, thus eliminated the need for cool-down between runs. Since the ethanol and methanol elute quickly from the non-polar HP-1 column, a single heart-cut was used to transfer the alcohols and co-eluting hydrocarbons to the polar HP-Innowax column.

## Heart-Cutting MDGC Analysis of Ethanol and Methanol in Fuel Ethanol

Automated back flush was also used to reduce the analysis time. Ethanol eluted from the secondary column within 3 minutes. However, the heavy hydrocarbons were still trapped on primary column. This column was back flushed at 45 °C with a 30 mL/min carrier gas flow. The heavy hydrocarbons are completely removed after 30 seconds of back flush. Using this technique, the overall analysis time for ethanol and methanol was reduced from 45 minutes to 3.5 minutes.

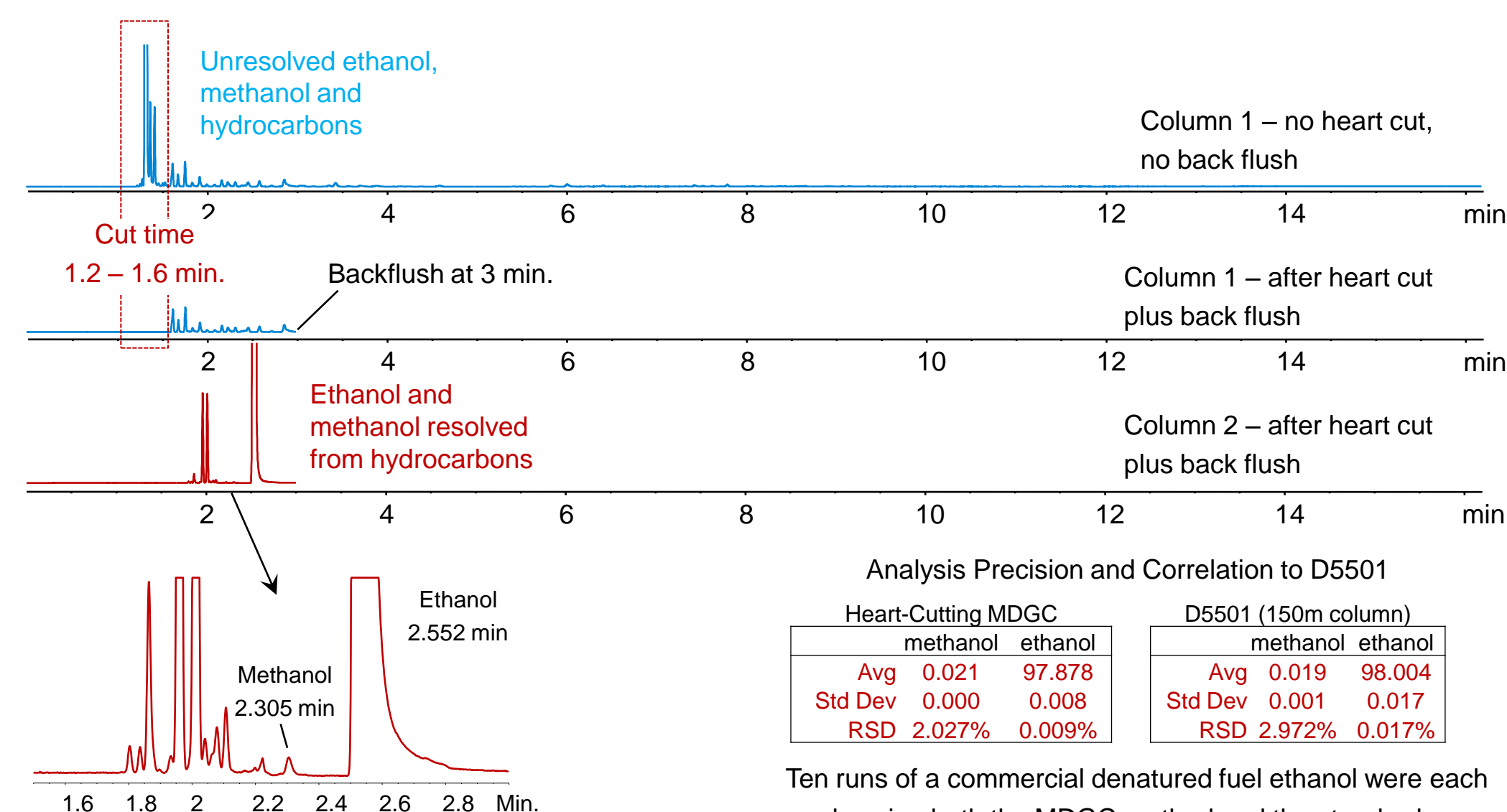

Analysis Precision and Correlation to D5501

Heart-Cutting MDGC		D5501 (150m column)	
methanol	ethanol	methanol	ethanol
Avg 0.021	97.878	Avg 0.019	98.004
Std Dev 0.000	0.008	Std Dev 0.001	0.017
RSD 2.027%	0.009%	RSD 2.972%	0.017%

The use of MDGC completely resolved methanol from isobutane.

## Combining Multiple Analyses on A Single Instrument

Multiple heart-cuts can be performed in a single run, thus allowing multiple analyses for improved productivity. For the analysis of ethanol fuels, aromatic compounds such as benzene and toluene can be easily separated from the hydrocarbon matrix using the GC conditions for the ethanol and methanol analysis. Individual cut times for benzene and toluene were determined on the primary column and the retention times of each peak measured on the secondary column. After the elution of toluene, backflush was applied for 1 minute to remove heavy hydrocarbons trapped on column 1.

## Denatured Fuel Ethanol – Methanol, Ethanol, Benzene and Toluene Analysis is a Single Run

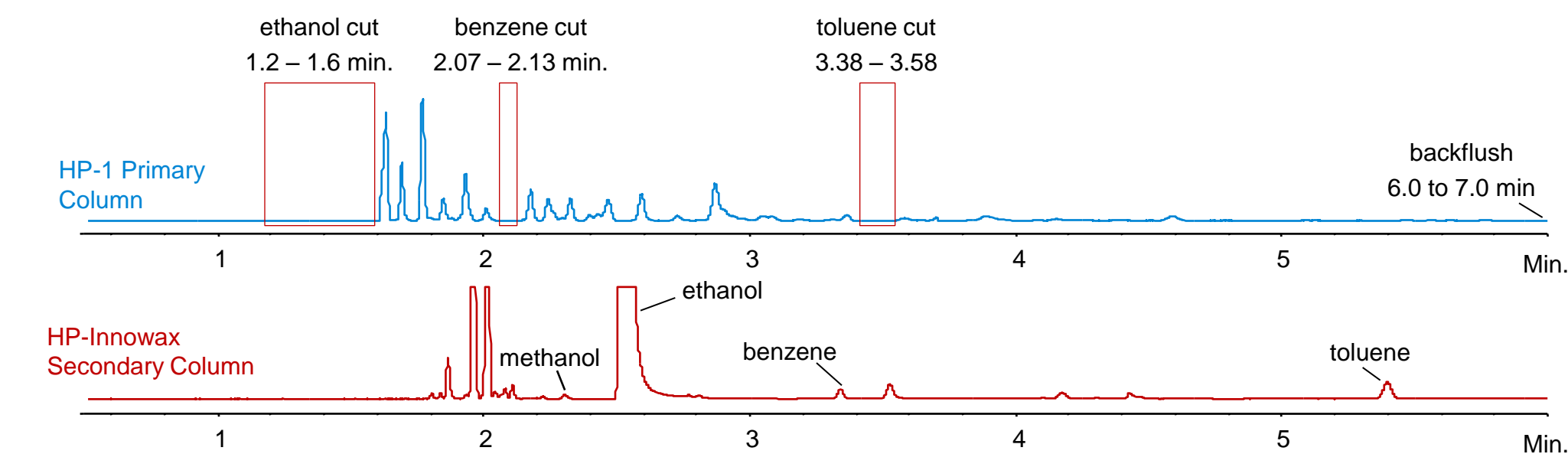

## Analysis of Other Commercial Ethanol Fuels Using Heart-Cutting MDGC

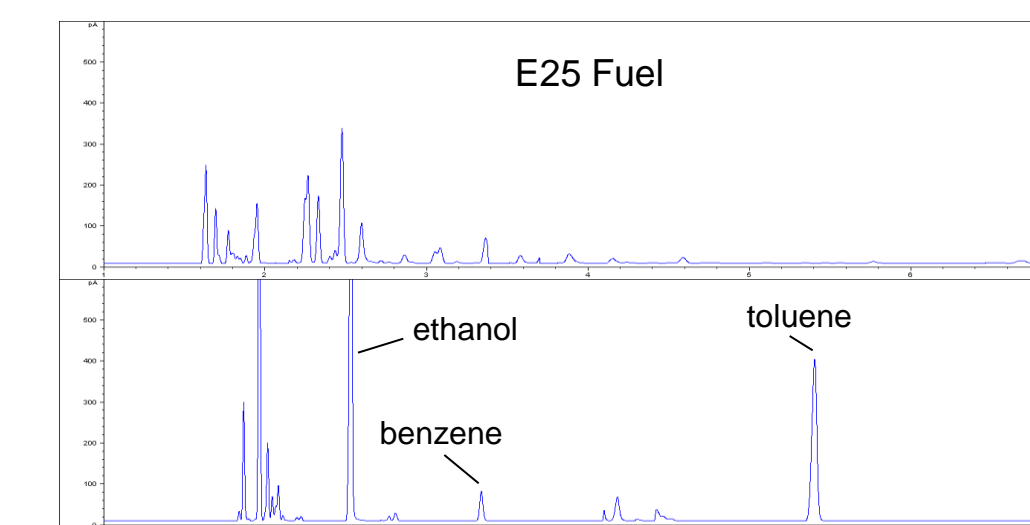
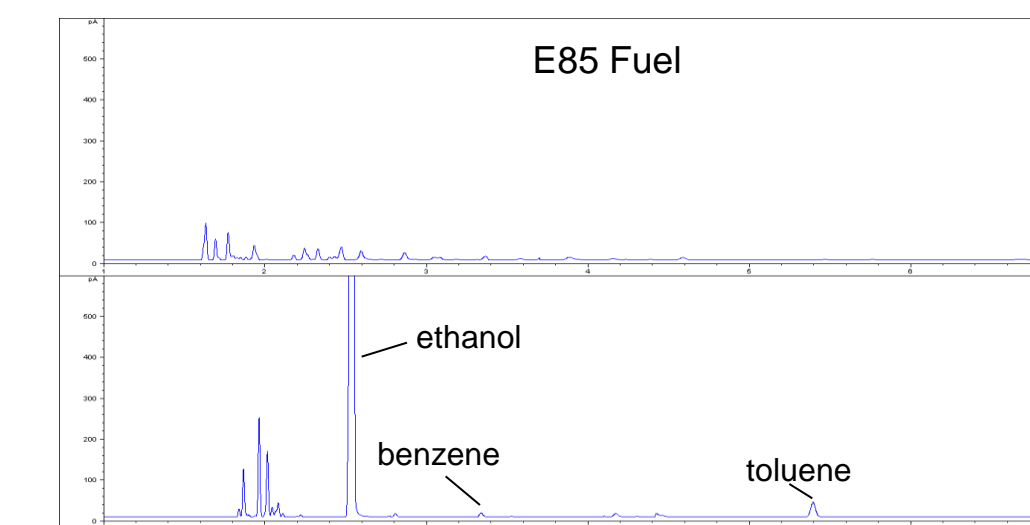

Commercial ethanol fuels are made by blending denatured fuel ethanol with various ratios of petroleum gasoline. The ethanol, methanol, benzene and toluene content must also be measured in these fuels. Two samples of commercial ethanol fuels, E25 and E85, were obtained and run along with the denatured fuel ethanol using this MDGC method. Three consecutive runs were made for each sample. The table below shows excellent precision for each sample

Denatured Fuel Ethanol				
	methanol	ethanol	benzene	toluene
avg wt%	<0.021	97.881	0.006	0.016
RSD	2.794%	0.003%	3.892%	3.677%
E85 Flex Fuel				
	methanol	ethanol	benzene	toluene
avg wt%	<0.010	81.802	0.049	0.246
RSD		0.598%	3.876%	4.016%
E25 Fuel				
	methanol	ethanol	benzene	toluene
avg wt%	<0.010	23.692	0.330	2.740
RSD		1.807%	2.020%	3.469%

## Summary and Conclusion

### Improving Speed, Accuracy, and Productivity For Renewable Bio-Ethanol Fuel Analysis

- Alcohol analysis time reduced from 45 minutes to 3.5 minutes
  - heart-cutting MDGC using two short, orthogonal columns
  - complete resolution of methanol from light hydrocarbons
  - back flush capabilities to reduce run time to 3.5 minutes
  - isothermal temperature eliminates cycle time between runs
- Benzene and toluene analysis easily added to MDGC method eliminates the need for second GC