

Infinity 90 Series User Manual



Contents

Change History	4
How to use this manual	4
Introduction	5
Warranties and Liabilities	6
Safety Notices	7
Symbols	7
Safety Notice to Users	7
Declaration of Conformity	8
Environmental Declaration	9
Technical Specification	10
Environment	10
Generator Outlets	10
Electrical Requirements	10
General	10
Technical Specification	11
Environment	11
Generator Outlets	11
Electrical Requirements	11
General	11
Unpacking	12
Installation	13
Generator Environment	13
General Dimensions	13
Unit Controls	14
Rear Connections	15
Fittings Kit	15
Drain Connection	15
Air Connection	16
Electrical Connection	16
Commissioning	17
Tubing Lengths	17
IMPORTANT DOCUMENTS	18
Normal Operation	19
On Demand Gas	19

Cleaning	19
Service Requirements	20
Service Schedule	20
Safely Isolated Condition	20
Safe State After Repair	21
Product Overview	22
Breathing Air Filter Element Replacement	23
RAC Filter Element Replacement	23
Pressure Switch	25
Overview	25
Pressure Settings	25
Procedure to set Pressure Switch	25
Trouble Shooting	27
Infinity 9010 Pneumatic Schematic Rev 1	28
Infinity 9020 Pneumatic Schematic Rev 1	29
Infinity 9030 Pneumatic Schematic Rev 1	30
Infinity 9040 Pneumatic Schematic Rev 1	31
Infinity 9050 Pneumatic Schematic Rev 3A	32
Infinity 9060 Pneumatic Schematic Rev 1	33
Infinity 9070 Pneumatic Schematic Rev 1	34
Infinity 9080 Pneumatic Schematic Rev 1	35
Infinity 90 Series Electrical Schematic Rev 1	36

Change History

Rev.	Comment	Name	Date
1	Update to Service Kit Information	Liam Couttie	16/04/2014
2A	Added 230v US Cable to Fittings Kit	Liam Couttie	07/10/2014
3A	9050 Pneumatic Diagram Update	Liam Couttie	27/01/2015
4	Content Update	Liam Couttie	12/04/2017

How to use this manual

This manual is intended for end users and has been written so that it can either be read as a step by step guide to installation and usage; or as a reference document where you can skip to the relevant information.

Please review each of the following sections carefully.

Thank you for selecting Peak Scientific to meet your Gas Generation needs, should you require any further assistance or support please do not hesitate to contact Peak Scientific or the Peak Partner from which you purchased your Generator

Introduction

The Peak Scientific Infinity 90* Generator is designed to cater for the requirements of LCMS, Evaporators and other N₂ consuming applications.

Warranties and Liabilities

1. The Company warrants that it has title to the Goods.
2. Subject to the provisions of this clause the Company warrants that the Goods shall comply in all material respects with any specification referred to in the Order Confirmation (as the same may be amended) and shall, subject thereto, be free from defects in material and workmanship for the lesser of a period of twelve months from the date of delivery or thirteen months from the date of dispatch from the factory.
3. Save as provided in this clause and except where the Goods are sold to a person dealing as a consumer (within the meaning of the Unfair Contract Terms Act 1977) all warranties, conditions or other terms implied by statute or common law are hereby expressly excluded save to the extent they may not be lawfully excluded. When the Goods are sold to a consumer within the meaning of the Unfair Contract Terms Act 1977 their statutory rights are not affected by the provisions of this clause.
4. In the event of the Customer making a claim in respect of any defect in terms of clause 2 hereof the Customer must.
 - 4.1. Reasonably satisfy the Company that the Goods have been properly installed, commissioned, stored, serviced and used and without prejudice to the generality of the foregoing that any defect is not the direct or indirect result of lack of repair and/or servicing, incorrect repair and/or servicing, use of wrong materials and/or incorrect spare parts
 - 4.2. Allow the company to inspect the Goods and/or any installation and any relevant packaging as and when reasonably required by the Company.
5. Subject to the Company being notified of any defect as is referred to in sub-clause 2 hereof within a reasonable time of it becoming apparent and subject always to the terms of sub-clause 4 hereof, the Company shall, in its option, replace or repair the defective Goods or refund a proportionate part of the Price. The Company shall have no further liability to the Customer (save as mentioned in sub-clause 6 hereof).
6. The Company shall be liable to indemnify the Customer in respect of any claim for death or personal injury to any person in so far as such is attributable to the negligence or breach of duty of the Company or any failure by the Company to comply with the provisions of sub-clause 2 hereof.
7. Save as provided in sub-clause 2 hereof the Company shall not be liable in respect of any claim by the Customer for costs, damages, loss or expenses (whether direct, indirect, consequential or otherwise) or indemnity in any respect howsoever arising including, but not by way of limitation, liability arising in negligence (other than pursuant to clause 6 above) that may be suffered by the Customer or any third party.

Safety Notices

Symbols

This manual uses the following symbols to highlight specific areas important to the safe and proper use of the Generator.



	A WARNING notice denotes a hazard. It calls attention to an operating procedure, process or similar, which if not correctly performed or adhered to, could cause personal injury or in the worst case death. Do not proceed beyond a WARNING notice until the indicated conditions are fully understood or met.
	A CAUTION notice denotes a hazard. It calls attention to an operating procedure, process or similar, which if not correctly performed or adhered to, could cause damage to the Generator or the Application. Do not proceed beyond a CAUTION notice until the indicated conditions are fully understood or met.
	Caution, risk of electric shock. Ensure power to the Generator has been removed before proceeding.

Table 1 - Safety Symbols

Safety Notice to Users



These instructions must be read thoroughly and understood before installation and operation of your Peak Scientific Infinity 90*. Use of the Generator in a manner not specified by Peak Scientific MAY impair the SAFETY provided by the equipment.



When handling, operating or carrying out any maintenance, personnel must employ safe engineering practices and observe all relevant local health and safety requirements and regulations. The attention of UK users is drawn to the Health and Safety at Work Act 1974, and the Institute of Electrical Engineers regulations.



Nitrogen is not a poisonous gas, but if the concentration in the inhaled air becomes too high there will be a risk of asphyxiation.

Declaration of Conformity

We **Peak Scientific Instruments Ltd.**

of **Fountain Crescent, Inchinnan. Renfrewshire PA4 9RE**
declare that:

Equipment **Nitrogen Gas Generator**

Model **Infinity 90***

To which this declaration relates, is in conformity with the applicable EC Directives, harmonized standards, and other normative requirements.

- **Low Voltage Directive 2006/95/EC**
EN 61010-1: 2010
Safety Requirements for Electrical Equipment for Measurement, Control and Laboratory Use.
Part 1: General requirements.

CAN/CSA-C22.2 No.61010-1-04
Safety requirements for Electrical Equipment for Measurement, Control and Laboratory use, Part 1: General requirement.
- **Electromagnetic Compatibility Directive 2004/108/EC**
EN 61326-1: 2006
Electrical Equipment for Measurement, Control and Laboratory Use - EMC Requirements.

All evaluation, testing and certification issued by:

Nemko Canada Inc.
303 River Road
Ottawa
Ontario
Canada
K1V 1H2

Signed By: 

Name: **Chris Pugh**

Position: **Engineering Director**

Done at: **Peak Scientific Instruments Ltd, Inchinnan, Scotland.**

Date: **26th of November 2012**



Environmental Declaration

We Peak Scientific Instruments Ltd.
of Fountain Crescent, Inchinnan. Renfrewshire PA4 9RE
declare that:

Equipment Nitrogen Gas Generator
Model Infinity 90*

Is fully compliant with the following Directives:

2002/96/EC WEEE (Waste of Electrical and Electronic Equipment)

2002/95/EC RoHS (Restriction of Hazardous Substances)

Peak Scientific Instruments Ltd fully complies with its obligations towards the European WEEE (Waste of Electrical and Electronic Equipment) Directive 2002/96/EC. These obligations are being met within the B2B compliance group.

Peak Scientific Instruments Ltd has developed all reasonable 'due diligence' controls to ensure that our products comply with the principles and requirements of the European RoHS (Restriction of Hazardous Substances) Directive 2002/95/EC. Similar directives in the United States and China, for example, have also been captured within this program.

Where a specific certificate of compliance is required, this can be requested, on a product serial number basis, directly from Peak Scientific Instruments Ltd, by contacting us through our website on www.peakscientific.com

Signed By: 
Name: Chris Pugh
Position: Engineering Director
Done at: Peak Scientific Instruments Ltd, Inchinnan, Scotland.
Date: 26th of November 2012



Technical Specification

Environment

	9010	9020	9030	9040
Minimum Operating Ambient Temperature	5°C (41°F)			
Maximum Operating Ambient Temperature*	30°C (86°F)			
Maximum Relative Humidity	70%			

* Maximum safety ambient temperature 35°C

** When taken out of storage the Generator should be allowed to acclimatize at room temperature for a minimum of 3 hours before operation.

Generator Outlets

Minimum Air Inlet Pressure	125 psi (8.7 bar)			
Maximum Air Inlet Pressure	145 psi (9.9 bar)			
Minimum Air Inlet Flow	260l/min	520l/min	780l/min	1040l/min
Maximum Gas Output Pressure	100 psi (6.8 bar)			
Maximum Pressure Drop (Outlet-Inlet)	8 psi (0.55 bar)			
Maximum Outlet Flow (High Purity Nitrogen)	140 l/min	280 l/min	420 l/min	560 l/min
Start-Up Time For Purity	60 minutes			
Particles	0.01 µm			

Electrical Requirements

Voltage	100V	230V
Frequency	60Hz	50Hz
Current	0.222A	0.123A
Fuse	S506-1.6-R	
Input connection	C20 Plug	
Power cord (Supplied)	C19 socket to local connection (13A minimum)	
Pollution degree	2	
Installation category	II	

General

Dimensions in cm (inches) W x D x H	50 (19.6) x 80 (31.5) x 115 (45.2)			
Weight kg/lbs	70/154	75/165	80/176	85/187
Shipping weight kg/lbs	73/161	78/172	83/183	88/194
Noise level	10 dBA @ 1m			



It should be noted that the gas pressures and flows are factory set. The pressures shown on the Generator front panel are in excess of the maximum inlet pressure of the Mass Spectrometer. This is to allow for known pressure drops.

Technical Specification

Environment

	9050	9060	9070	9080
Minimum Operating Ambient Temperature	5°C (41°F)			
Maximum Operating Ambient Temperature*	30°C (86°F)			
Maximum Relative Humidity	70%			

* Maximum safety ambient temperature 35°C

** When taken out of storage the Generator should be allowed to acclimatize at room temperature for a minimum of 3 hours before operation.

Generator Outlets

Minimum Air Inlet Pressure	125 psi (8.7 bar)			
Maximum Air Inlet Pressure	145 psi (9.9 bar)			
Minimum Air Inlet Flow	1300l/min	1560l/min	1820l/min	2080l/min
Maximum Gas Output Pressure	100 psi (6.8 bar)			
Maximum Pressure Drop (Outlet-Inlet)	8 psi (0.55 bar)			
Maximum Outlet Flow (High Purity Nitrogen)	700 l/min	840 l/min	980 l/min	1120l/min
Start-Up Time For Purity	60 minutes			
Particles	0.01 µm			

Electrical Requirements

Voltage	100V	230V
Frequency	60Hz	50Hz
Current	0.222A	0.123A
Fuse	S506-1.6-R	
Input connection	C20 Plug	
Power cord (Supplied)	C19 socket to local connection (13A minimum)	
Pollution degree	2	
Installation category	II	

General

Dimensions in cm (inches) W x D x H	50 (19.6) x 80 (31.5) x 115 (45.2)			
Weight kg/lbs	90/193	95/209	100/220	105/231
Shipping weight kg/lbs	93/205	98/216	103/227	108/238
Noise level	54 dBA @ 1m			

Unpacking

Although Peak Scientific takes every precaution with safe transit and packaging, it is advisable to fully inspect the unit for any sign of transit damage.

Check 'SHOCKWATCH' label for signs of rough handling prior to un-packing –



Any damage should be reported immediately to the carrier and Peak Scientific or the Peak Partner from where the unit was purchased.

Follow the unpacking instructions posted on the side of the crate. It will require two people to remove the unit from the shipping crate and to manoeuvre the Generator onto the floor.

Please save the product packaging for storage or future shipment of the Generator.

Note: Included with the Generator is a "Fittings Kit" containing mains power leads for UK, EU and US also all the required fittings. Be careful not to discard these with the packaging.

Installation

Generator Environment



The Generator is designed for indoor use only. It should be installed adjacent to the Mass Spectrometer(s) it is supplying. If this is not convenient then the unit can be sited elsewhere, however, consideration should be made of the lengths of pipe runs as pressure drops can result from extended runs of pipe. Please see the [Tubing lengths](#) section for further details.



Performance of the Generator (like all sophisticated equipment) is affected by ambient conditions. Note should also be taken to the proximity of Air Conditioning outlets. These can sometimes give rise to “pockets” of air with high relative humidity. Operation of the unit within such a pocket could adversely affect its performance. Consideration should also be given to the air flow around the unit. It is recommended that an air gap of 75mm (3”) should be maintained down both sides, at the rear and across the top of the unit. Please refer to the drawing below for the general dimensions of the unit.

Maximum Ambient Conditions: 30°C (dry bulb) 80%RH (Max) Non-Condensing

General Dimensions

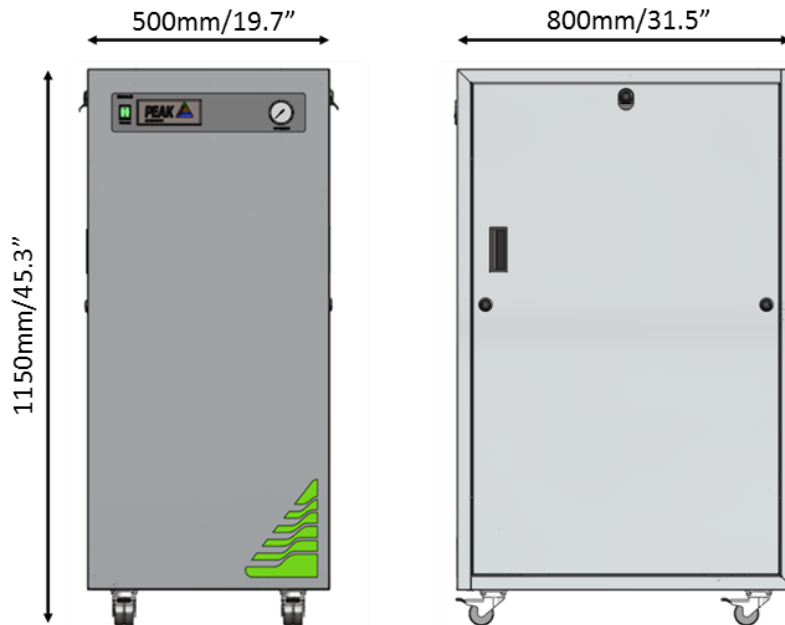

The Generator must always be placed on a level surface. Failure to do so will affect the performance of the Generator.

Unit Controls

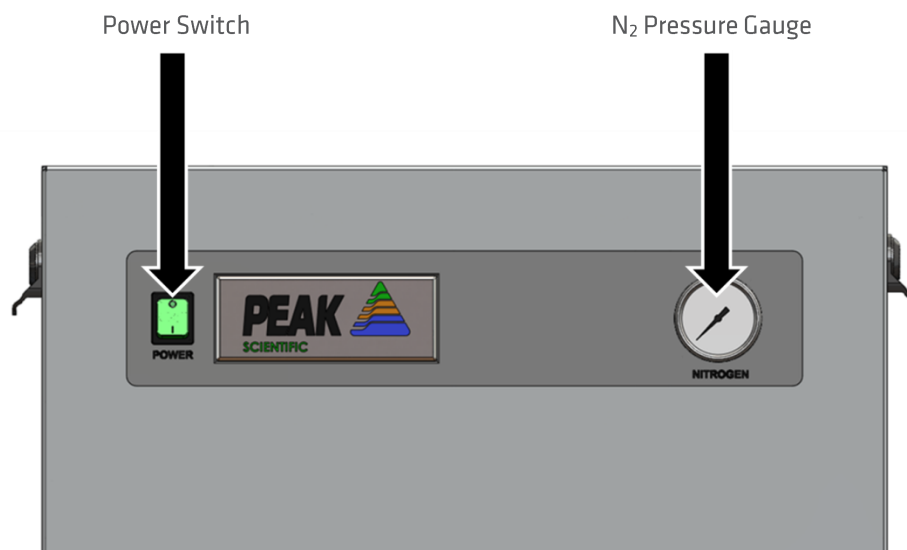

Rear Connections

Fittings Kit

Supplied in the Fittings Kit are all the fittings required to connect the Infinity 90* Generator to the appliance. The contents of the Fittings Kit are as follows:

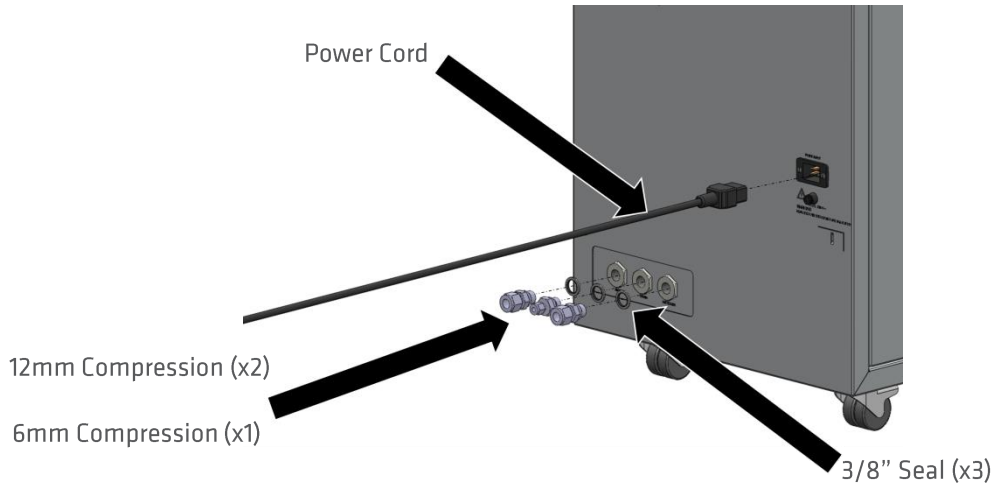

- | | |
|-------------------------------------|------|
| 1. 8mm Hex Key | x 1 |
| 2. 6mm Compression Fitting | x 1 |
| 3. 12mm Compression Fitting | x 2 |
| 4. 3/8" Seal | x 3 |
| 5. 6mm Tubing | x 3m |
| 6. 12mm Tubing | x 6m |
| 7. C19 Mains Cable (UK) | x 1 |
| 8. C19 Mains Cable (Euro) | x 1 |
| 9. C19 Mains Cable (US 110v) | x 1 |
| 10. C19 Mains Cable (US 230v) | x 1 |
| 11. Installation Guide Infinity 90* | x 1 |
| 12. User Manual Disc Infinity 90* | x 1 |

All of the Generator output ports are located on the output panel at the rear of the Generator.

Drain Connection

Fit the 6mm push fit fitting (item 2 from fittings kit) to the drain port located on the output panel. Tighten using a 16mm or 5/8" spanner. Use the 6mm tubing (item 4 from fittings kit) to connect this to a suitable drain connection or container. It should be noted that the Generator can expel a considerable amount of water from this (dependant on ambient humidity).



If a container is used it should be emptied at regular intervals. The container must NOT have an air tight seal as water and air are expelled at pressure.

Air Connection

The Nitrogen Generator should be connected to a clean, dry, OIL – FREE source of compressed air. A minimum pressure of 125 psig is required for efficient operation of the Generator. Any doubts as to the suitability of your compressed air supply should be referred to the factory for advice.

A MAXIMUM OIL VAPOUR CONTENT OF 0.01 mg per m³ is PERMISSIBLE

Air Inlet and Nitrogen Outlet connections are at the rear of the generator in the middle right side of the panel. The Air inlet connection is the left port, 12mm Swagelok Compression Fitting, Outlet port is 12mm Swagelok Compression Fitting. The generator is supplied with *Breathing Air* pre-filters and an *Activated Carbon* post filter, which are fitted internally. The *Breathing Air* filters will drain moisture and are equipped with automatic drains. This is connected to the 6mm Swagelok Compression Fitting, between the Input and Output connections. Any bulk moisture in the inlet air will be trapped by these filters and released through this drain port, which should be led to a convenient place.

Electrical Connection

Connect the Generator to an 85-264 VAC single-phase supply using the power cord provided. If the appropriate power cord is not supplied; a new plug, rated to at least 12 amps, can be fitted by a qualified electrician.



This unit is classified as SAFETY CLASS 1. THIS UNIT MUST BE EARTHED. Before connecting the unit to the mains supply, please check the information on the serial plate. The mains supply must be of the stated AC voltage and frequency.

EARTH/GROUND (E):-	Green & Yellow	or	Green
LIVE (L):-	Brown	or	Black
Neutral (N):-	Blue	or	White

Commissioning

With the Generator installed as described earlier. Disconnect the Nitrogen Outlet connection to allow the generator to vent to atmosphere until the unit is stabilized then open the air supply. The Generator has been pre-set in the factory to give the specified output flow-rate and pressure. Once the Membrane reaches the design pressure the Generator will stabilise and produce pure Nitrogen. Maximum purity will be achieved after around 1 hour. After this time the generator can be re-connected to the application.

The design of the generator is that it will deliver up to rated output flow of Nitrogen at 100 psig. Should the demand for Nitrogen be less than the rated output flow, or indeed should the demand stop the generator will Automatically go into standby mode this will switch off inlet Air supply, and on demand of Nitrogen the pressure switch will detect and energize solenoid valve and generator will start to produce Nitrogen. The generator is protected from over pressurising.

Tubing Lengths



The diameter of the tubing which will be connected to the gas outlet is important and is determined by the length of tubing required. Failure to follow these recommendations could lead to pressure between generator and application.

- | | |
|-------------------|---|
| < 10 meters: | Use 10/8 (10mm O/D, 8mm I/D) Tubing. |
| > 10 - 40 meters: | Use 12/10 (12mm O/D, 10mm I/D) Tubing. |
| > 40 metres: | Please contact Peak Scientific with the relevant distance and we will calculate the flow resistance and the tubing size required. |

A combination of 12/10 and 10/8 tubing may be used to ensure that there is no large diameter tubing within the lab (i.e. for the first 20 meters from the Generator use 12/10 and the final 10 meters to the Mass Spectrometer use 10/8 tubing). Keep the connections and bends to a minimum.

The imperial equivalents are: 10/8 = 3/8" O/D, 5/16" I/D
12/10 = 1/2" O/D, 3/8" I/D

IMPORTANT DOCUMENTS



Warranty Entitlement

To register your generator for your warranty entitlement, send the completed form to Peak Scientific by:

- Email warranty@peakscientific.com
- Online http://www.peakscientific.com/service-and-support/warranty_registration
- Phone +44 (0)141 530 4185
- Fax +44 (0)141 812 8200

PRODUCT WARRANTY REGISTRATION	
COMPANY:	CONTACT NAME:
ADDRESS:	
	EMAIL ADDRESS:
CITY/TOWN:	GENERATOR SERIAL NUMBER:
POSTCODE:	
COUNTRY:	MODEL TYPE:
TELEPHONE:	INSTALLATION DATE (DD/MM/YYYY):

Important Please Note:

You have 1 month to register your Peak Scientific product from the date of shipment.

If you wish to defer installation of your generator you must notify Peak Scientific within 1 month of the shipment date. This can be done by emailing warranty@peakscientific.com. Once registered the warranty will be honoured for a period of 12 months after the installation date.

For any generators that remain unregistered the warranty will begin from date of shipment.

Thank you on behalf of Peak Scientific.

Normal Operation

The Infinity 90* Gas Generator is designed specifically to minimize operator involvement. Given that the system is installed as described in earlier sections and is serviced in accordance with the specified maintenance recommendations (see [Service Requirements](#)), then it should simply be a matter of turning the Generator on when it is required.

The Generator will automatically produce the factory set flow and pressure as detailed in the [Technical Specifications](#).

On Demand Gas

Each individual system produces gas on demand. If the instrument is operating and requires a gas flow, the selected system will supply this to suit the requirements of the instrument. If the instrument requirement for gas stops, the system will also stop, once it has reached its upper set limit in the internal storage tanks. If the demand from the instrument starts again, the system will detect the demand for gas and will automatically start again to suit the demand.

Cleaning

Clean the outside of the Generator only using warm soapy water and a clean damp cloth. Ensure the cloth is thoroughly rung out to remove excess fluid prior to use.



Cleaning should only be undertaken with the power switched off and the power cord removed from the rear of the Generator.



Under no circumstances should any solvents or abrasive cleaning solutions be used as these can contain fumes that could be harmful to the Generator.



Care should be taken with Leak Detections Liquids.

Service Requirements



Servicing and/or repair of the Generator should only be undertaken by a **TECHNICALLY COMPETENT PERSON** with the Generator in a safely isolated condition.

Due to the simplicity of the design and the small number of moving parts the Infinity 90* Nitrogen Generators will have a long and trouble free life. However as with all scientific and technical equipment it should be regularly inspected and serviced as below.

Service Schedule

Service interval	Component	Part No.	9010-40	9050-80
			Qty.	Qty.
12 months	Element Active Carbon	00-0043	1	2
	Element 0.01 micron	00-0042	1	2
	RAC Filter Element	00-0041	1	1

As an alternative to purchasing the 12 month service items individually an Annual Service Kit is available as one part number. This contains all the filters required for this Generator.

Purchase Interval	Component	Part No.	Qty.
12 months	Annual Service Kit 9010-9040	08-0313	1
	Annual Service Kit 9050-9080	08-0314	1

Safely Isolated Condition

The unit is in a safely isolated condition when it is disconnected from its application and fully de-pressurised. Directions for isolating the Generator are shown below.



Failure to place the Generator in a safely isolated condition when instructed to do so may lead to personal injury or injury to others and even death.

- a) Switch generator off.
- b) Disconnect from air supply.
- c) Ensure the output pressure gauge reads zero. (If gauge does not fall to zero, loosen the outlet fitting slightly to allow trapped gas to escape).
- d) Disconnect from the application.

Safe State After Repair

To guarantee the generator is in a safe state after a repair, please ensure the following conditions are met;

- **All earth leads have been reconnected.**
Earth leads should be connected to the earth tabs located on the door panels, as shown below.

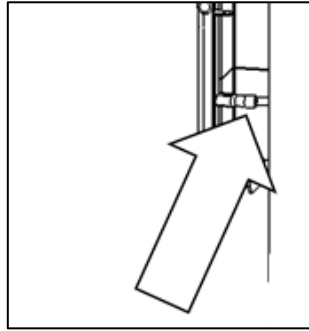

- **The electricity cable has been correctly refitted.**
The mains cable should be plugged into the IEC power inlet located on the rear panel of the generator. This unit is classified as SAFETY CLASS 1. THIS UNIT MUST BE EARTHED.

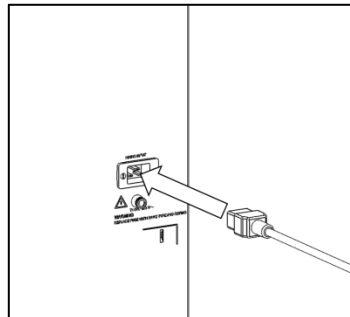

Product Overview

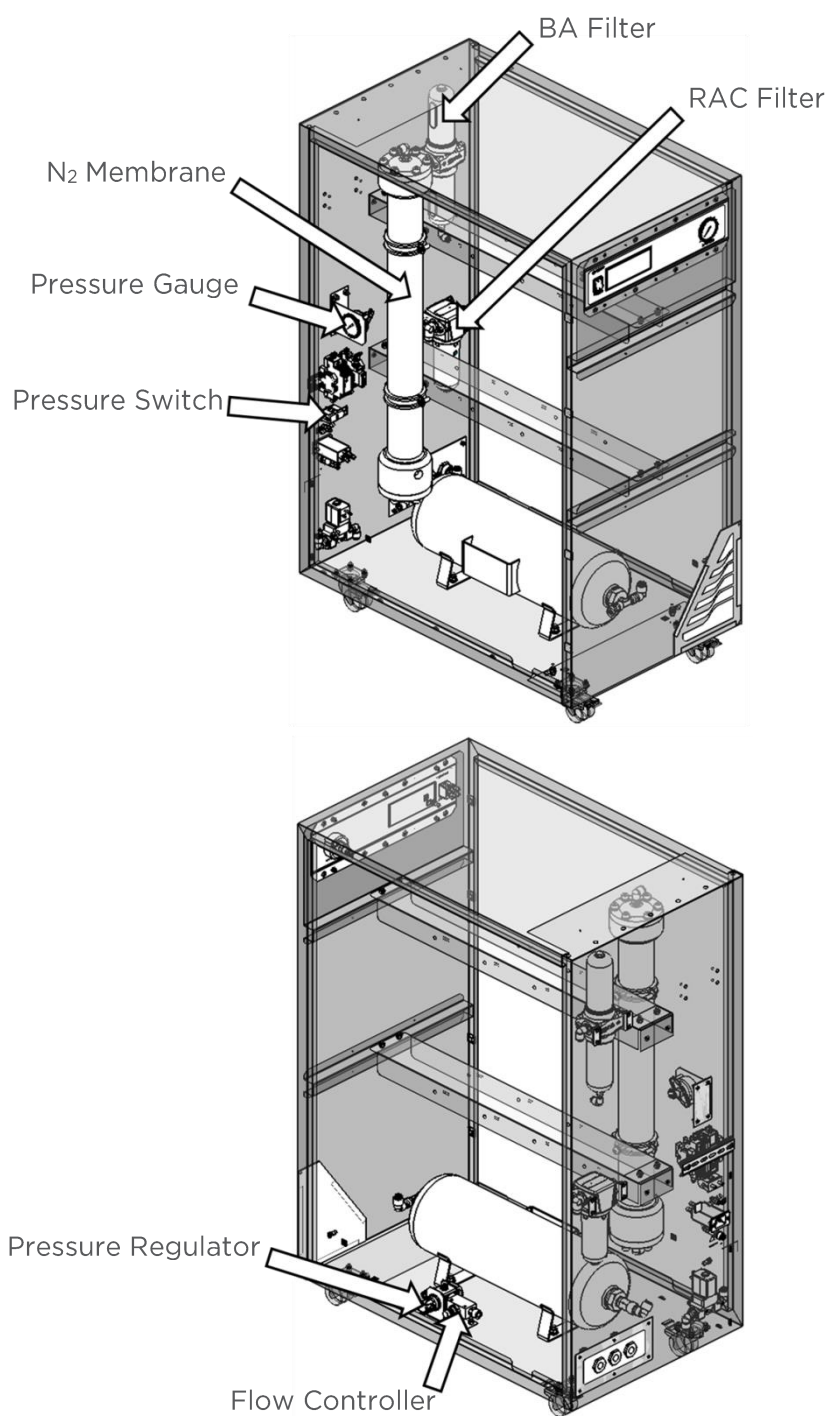

Breathing Air Filter Element Replacement



Ensure that Generator is in Safely Isolated Condition

1. Remove 6mm drain tubing from push-fit stud situated on under-side of the bowl.
2. Remove the top and bottom filter bowls by turning the bowl clockwise and anti-clockwise respectively.
3. Remove the filter element by pulling it away from the filter assembly.
4. Fit the replacement elements.
5. Re-fit the filter bowls.

00-0043

00-0042

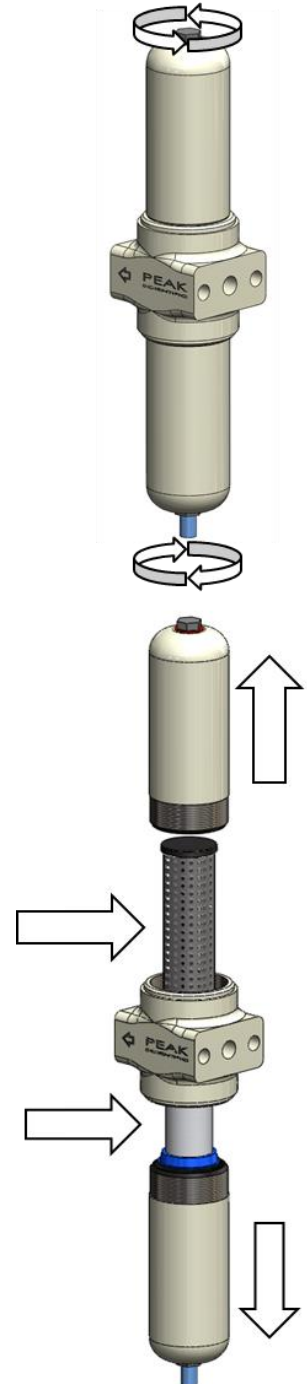

RAC Filter Element Replacement



Ensure that Generator is in Safely Isolated Condition

1. Open the filter bowl valve to ensure it is depressurised.
2. Remove the filter bowl by turning it as shown to reveal the RAC filter element Part number 00-0041.
 - a. For easier access, the filter assembly can be removed from the cabinet by removing the 4 of nyloc nuts and disconnecting the tubing.
3. Remove and replace the filter element and re-assemble.

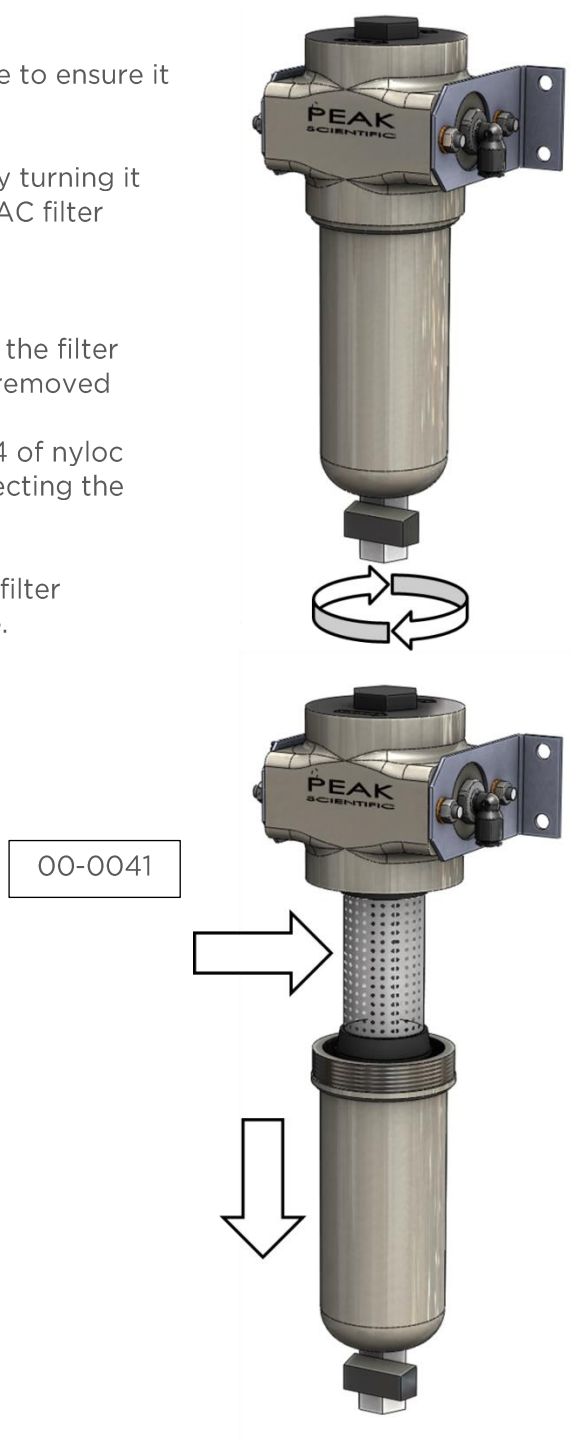

Pressure Switch



Accessing the electrical panel without safely isolating the Generator should only be carried out by trained service personnel

Overview

1. Electrical Connection
2. LED Display
3. Edit Button
4. Connection for Pressurised Air

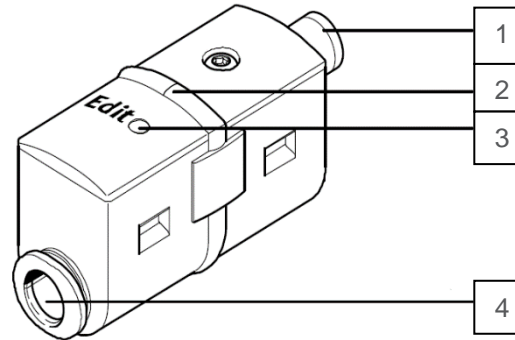

Pressure Settings

NM32LA Pressure Settings	
Pressure Limit	Pressure (PSI)
Upper	115
Lower	105

Table 2: NM32LA Pressure Settings

Procedure to set Pressure Switch

1. Close off the pressure regulator in the generator
2. Attach the external pressure regulator and valve assembly between the house air supply and the **AIR IN** port on the generator. Ensure the valve is in the closed position.
3. Connect the power cable to the generator and switch on the power.
4. On the house air regulator set the supply pressure as per the requirements listed in the Technical Specification of this manual.
5. Slowly release the house air supply to pressurise the tank.
6. When the internal gauge reads the required upper limit shown in the table above press the set button on the pressure switch, the LED will start to flash.
7. Close the shut off valve on the air supply in to the generator.
8. Gradually open the pressure regulator in the generator unit to reduce the tank pressure to the lower limit shown in the table above and press the button on the pressure switch to set the lower limit. The LED goes off.



Care should be taken so as to not over pressurise tanks

Trouble Shooting

Problem	Possible Solution
The Generator will not switch on & the power switch does not illuminate.	<ul style="list-style-type: none">• Ensure the power cord is plugged into the generator and that the power socket is turned on.• Check the fuse in the power cord plug.• Contact your service provider.
The generator will not switch on but the power switch is illuminated.	<ul style="list-style-type: none">• Disconnect the power cord from the rear of the unit.• Replace the fuse, reconnect the power cord.• Contact your service provider.

Infinity 90* User Manual

Infinity 9010 Pneumatic Schematic Rev 1

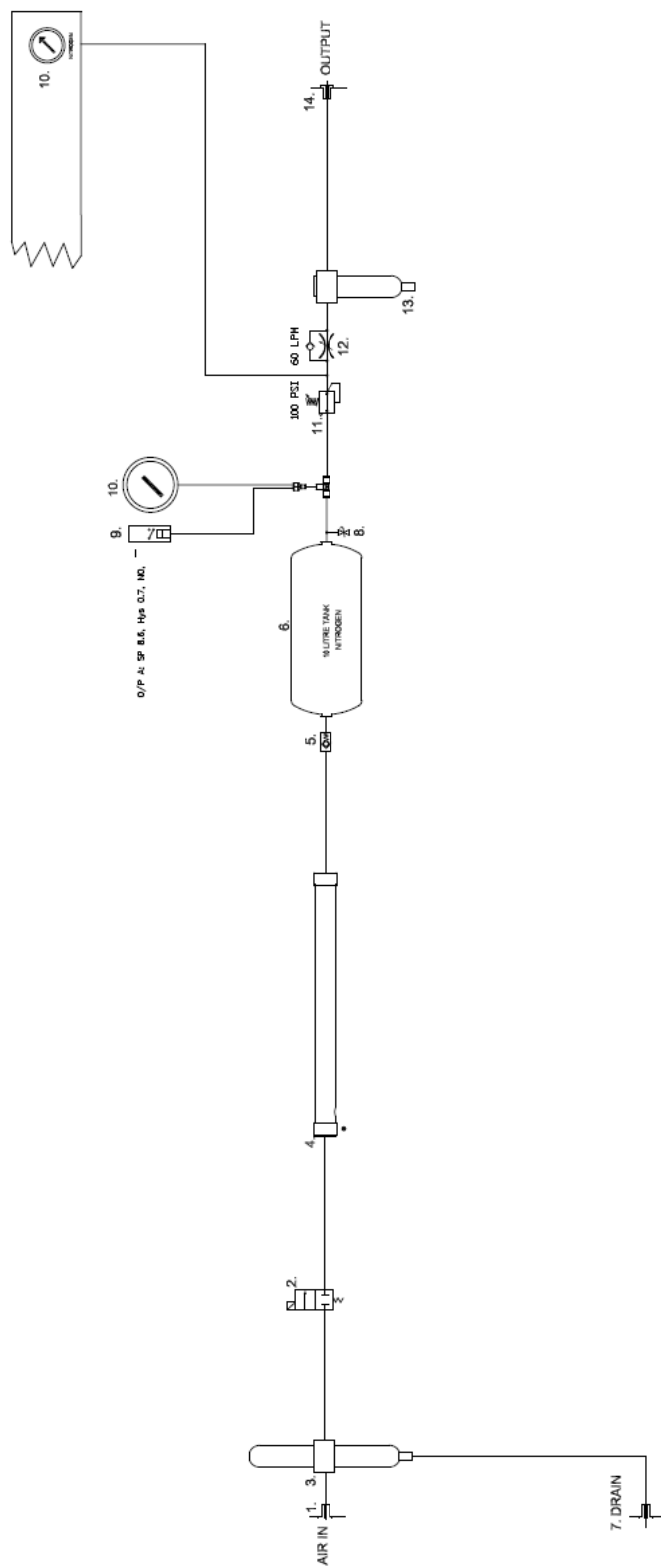

- 1. Air In
- 2. Inlet Valve
- 3. BA Filter
- 4. Membrane
- 5. Non-Return Valve
- 6. 10L Tank
- 7. Drain
- 8. Safety Relief Valve
- 9. Pressure Switch
- 10. Pressure Gauge
- 11. Pressure Regulator
- 12. Flow Controller
- 13. RAC Filter
- 14. Output

Infinity 90* User Manual

Infinity 9020 Pneumatic Schematic Rev 1

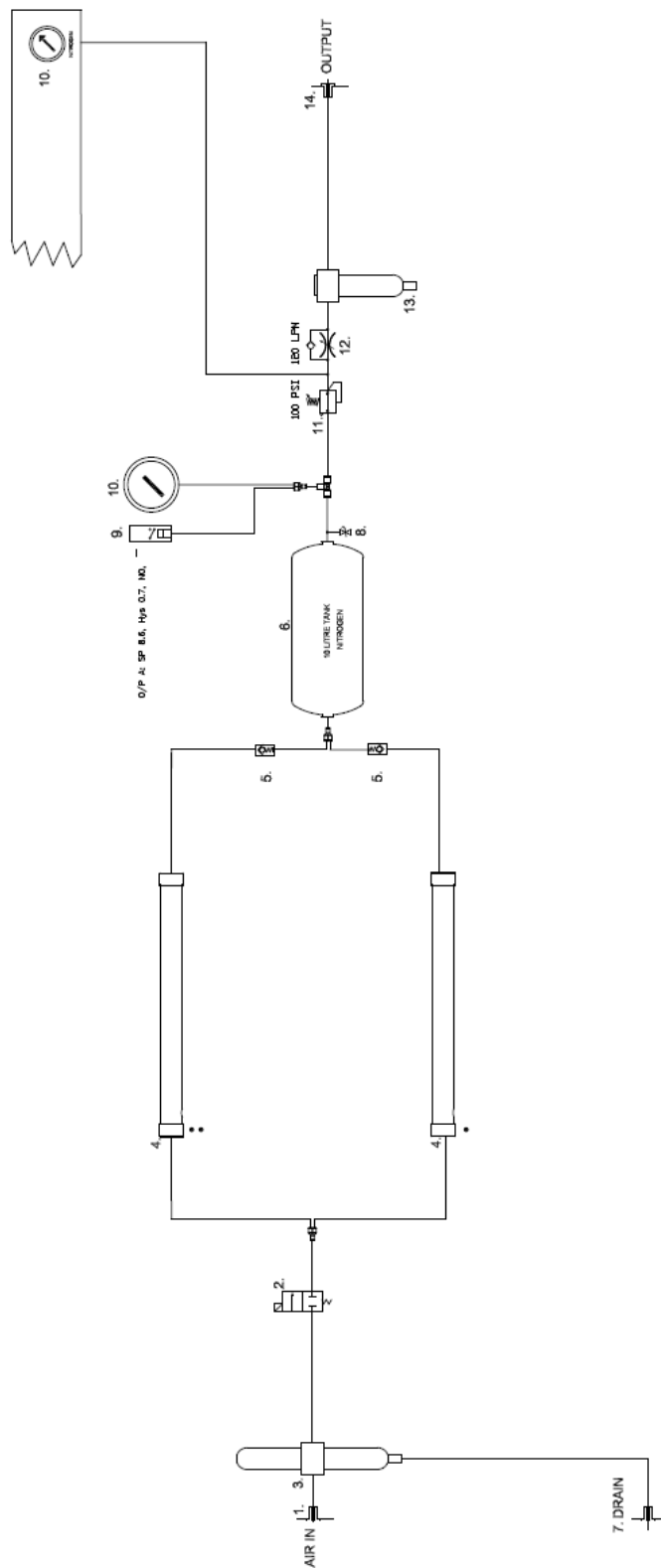

- 1. Air In
- 2. Inlet Valve
- 3. 3A Filter
- 4. Membrane
- 5. Non-Return Valve
- 6. 10L Tank
- 7. Drain
- 8. Safety Relief Valve
- 9. Pressure Switch
- 10. Pressure Gauge
- 11. Pressure Regulator
- 12. Flow Controller
- 13. RAC Filter
- 14. Output

Infinity 90* User Manual

Infinity 9030 Pneumatic Schematic Rev 1

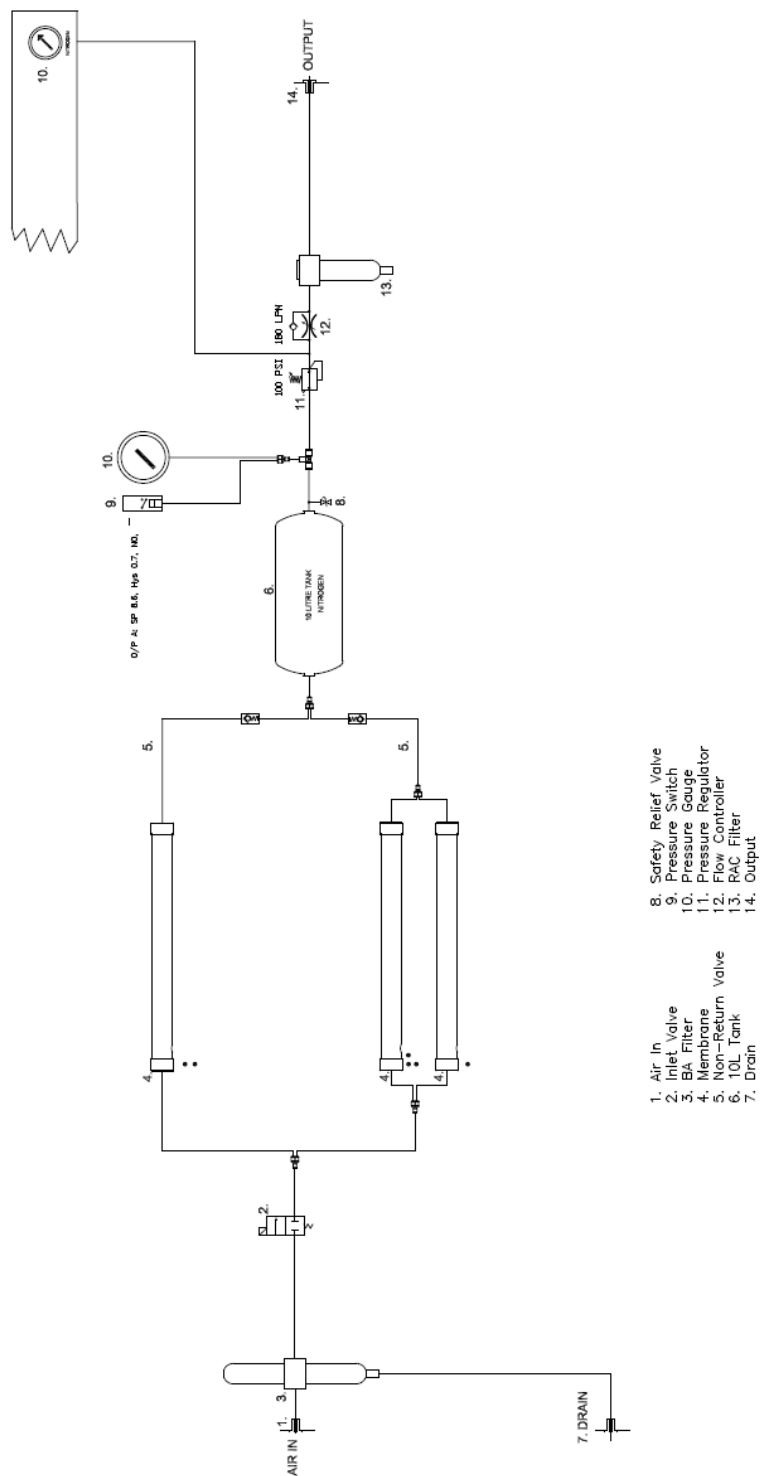

Infinity 90* User Manual

Infinity 9040 Pneumatic Schematic Rev 1

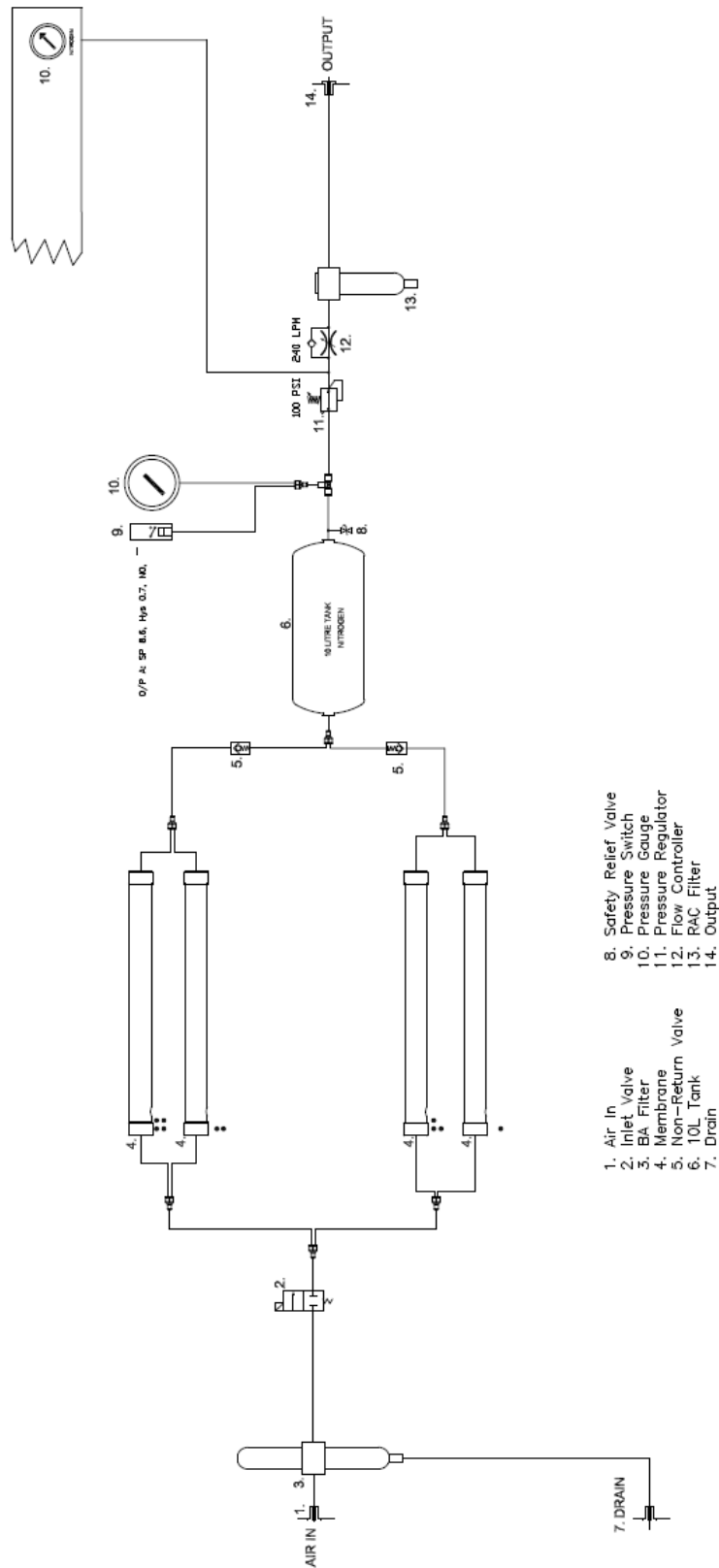

Infinity 90* User Manual

Infinity 9050 Pneumatic Schematic Rev 3A

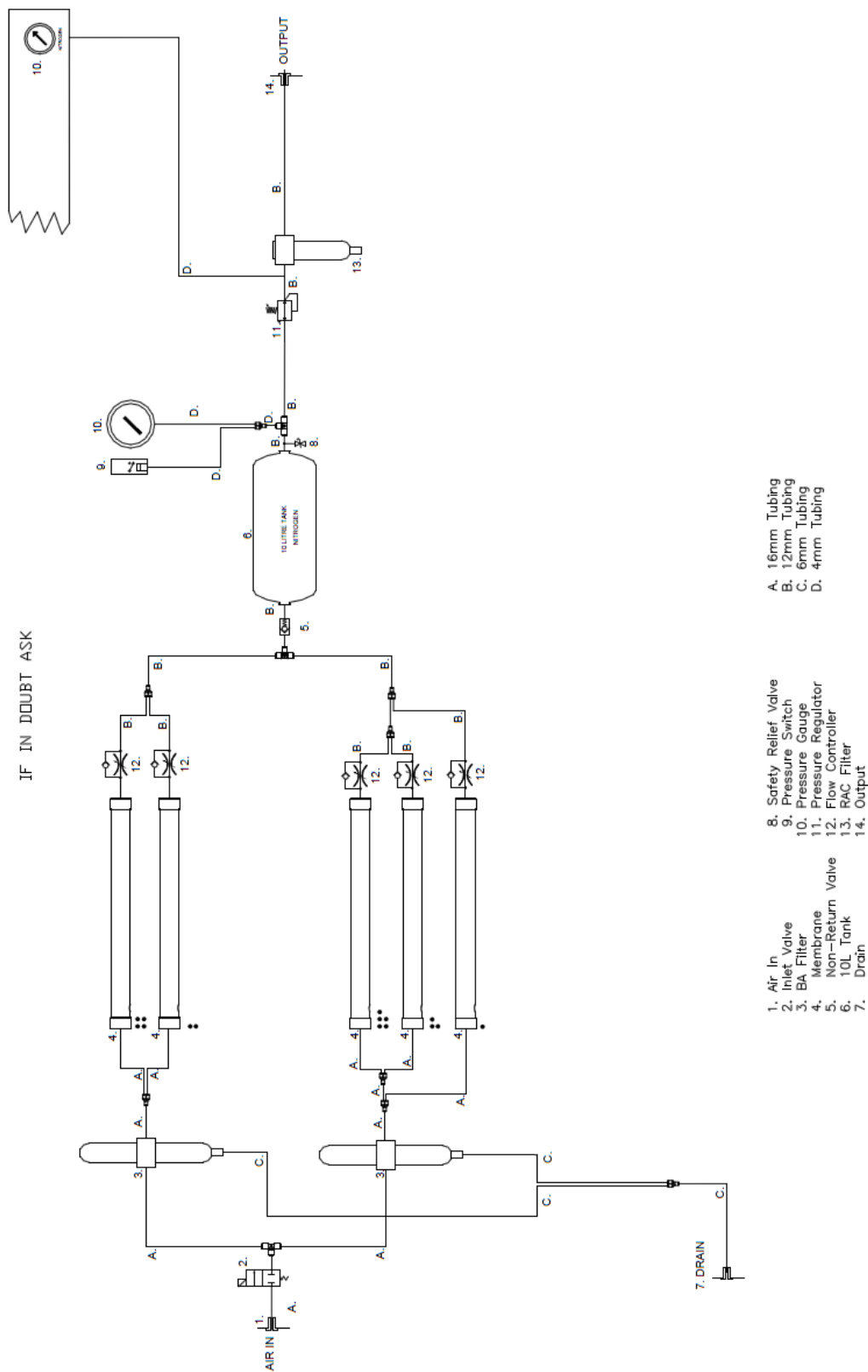

Infinity 90* User Manual

Infinity 9060 Pneumatic Schematic Rev 1

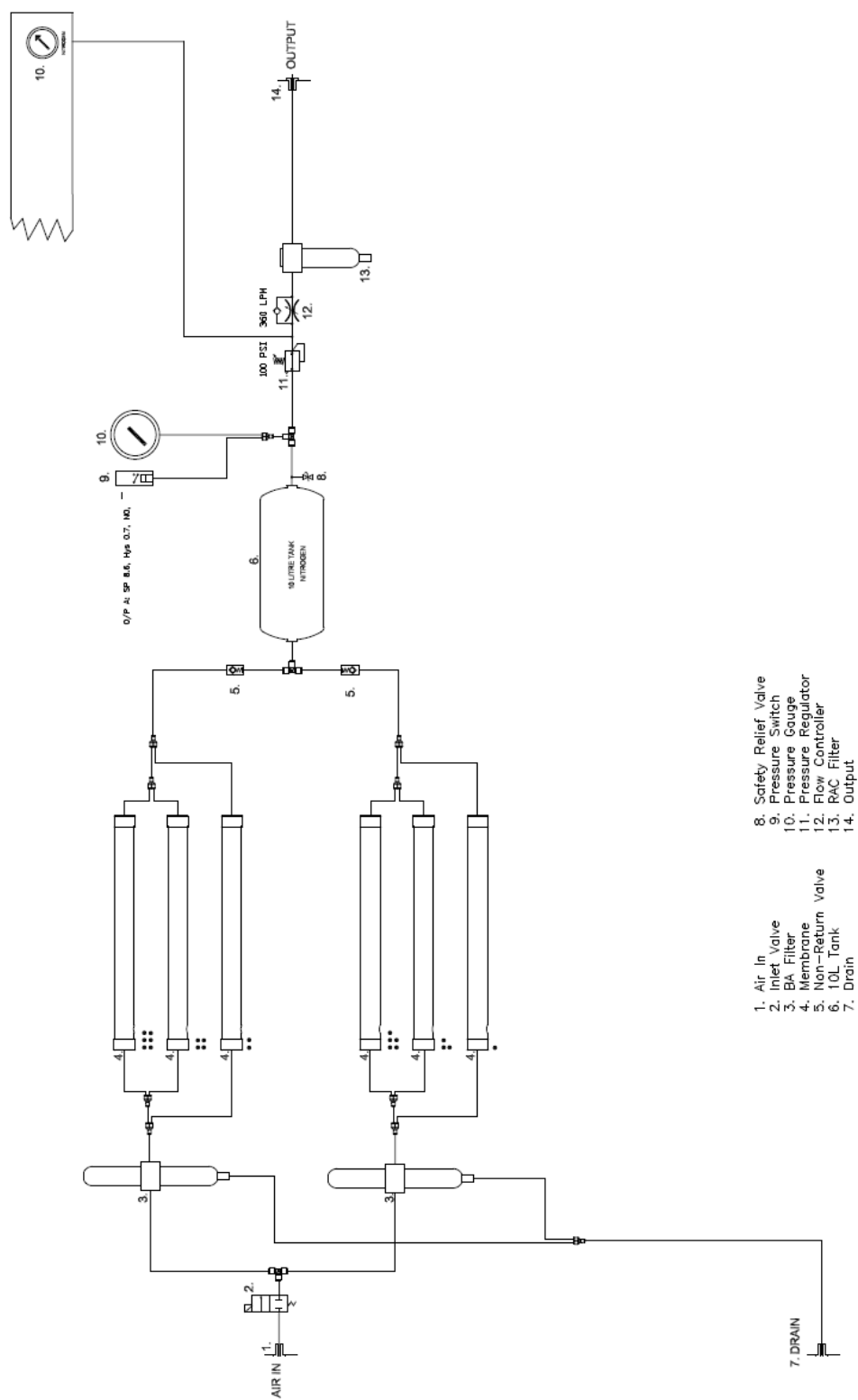

Infinity 90* User Manual

Infinity 9070 Pneumatic Schematic Rev 1

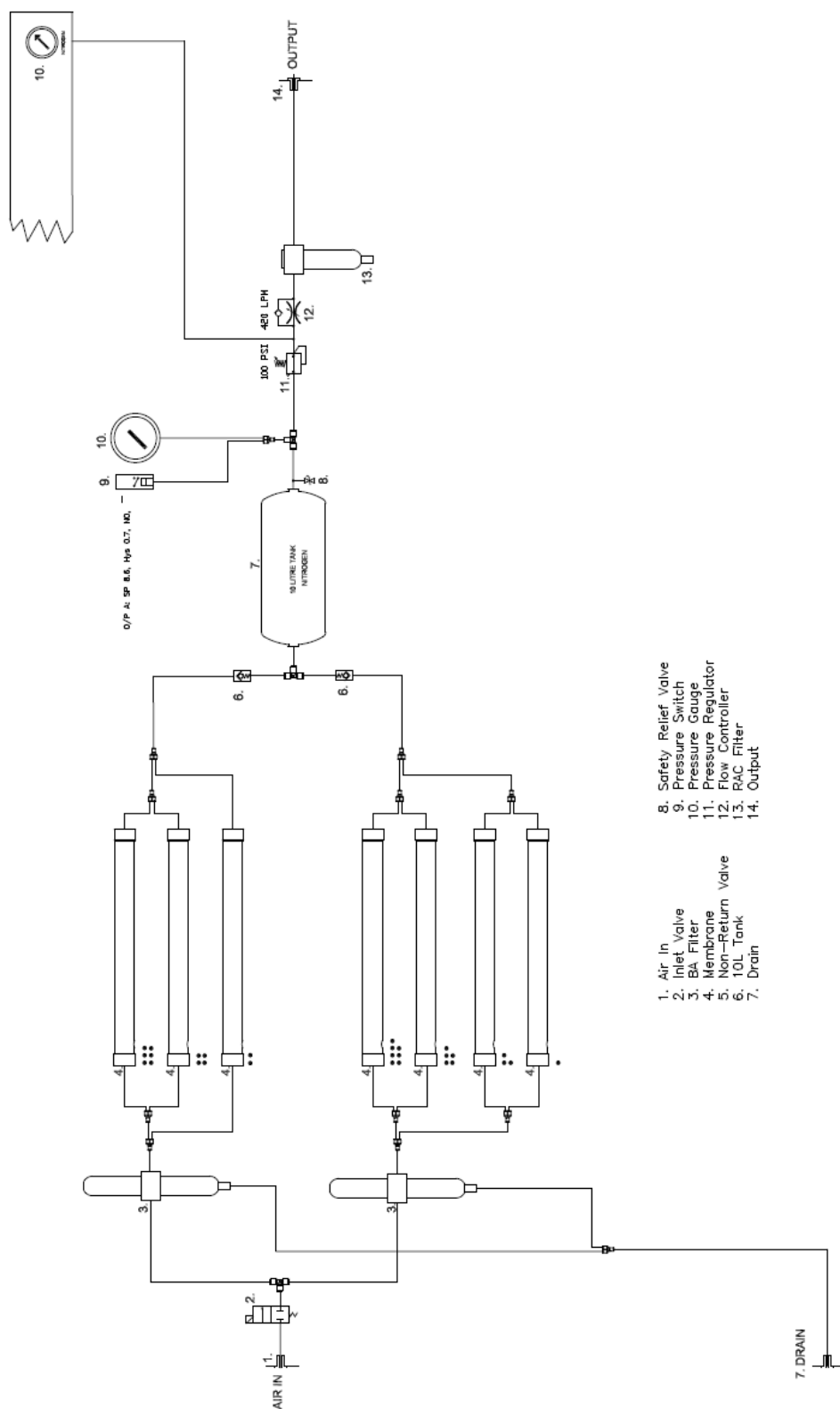

- 1. Air In
- 2. Inlet Valve
- 3. BA Filter
- 4. Membrane
- 5. Non-Return Valve
- 6. 10L Tank
- 7. Drain
- 8. Safety Relief Valve
- 9. Pressure Switch
- 10. Pressure Gauge
- 11. Pressure Regulator
- 12. Flow Controller
- 13. RAC Filter
- 14. Output

Infinity 90* User Manual

Infinity 9080 Pneumatic Schematic Rev 1

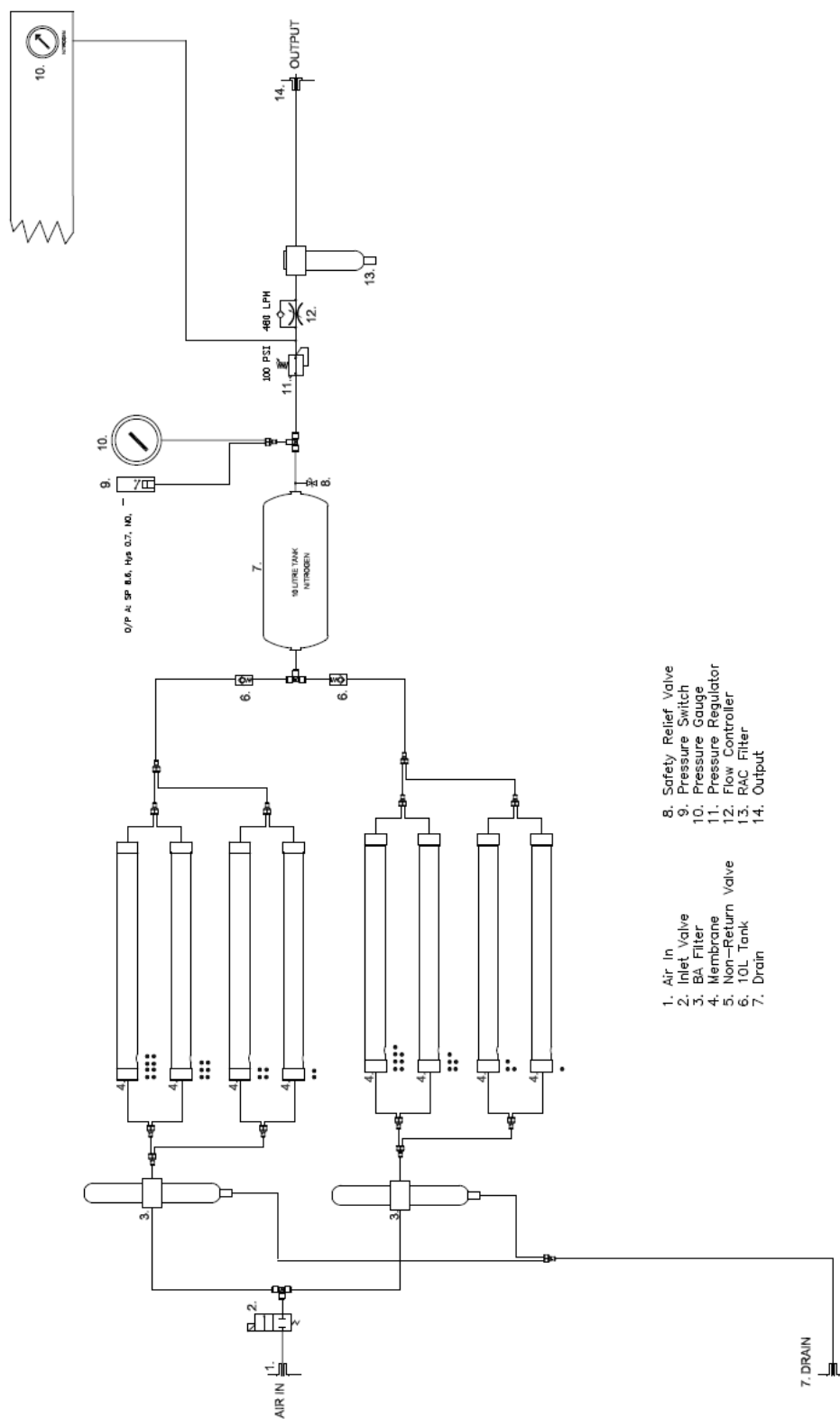

- 1. Air In
- 2. Inlet Valve
- 3. BA Filter
- 4. Membrane
- 5. Non-Return Valve
- 6. 10L Tank
- 7. Drain
- 8. Safety Relief Valve
- 9. Pressure Switch
- 10. Pressure Gauge
- 11. Pressure Regulator
- 12. Flow Controller
- 13. RAC Filter
- 14. Output

Infinity 90* User Manual

Infinity 90 Series Electrical Schematic Rev 1

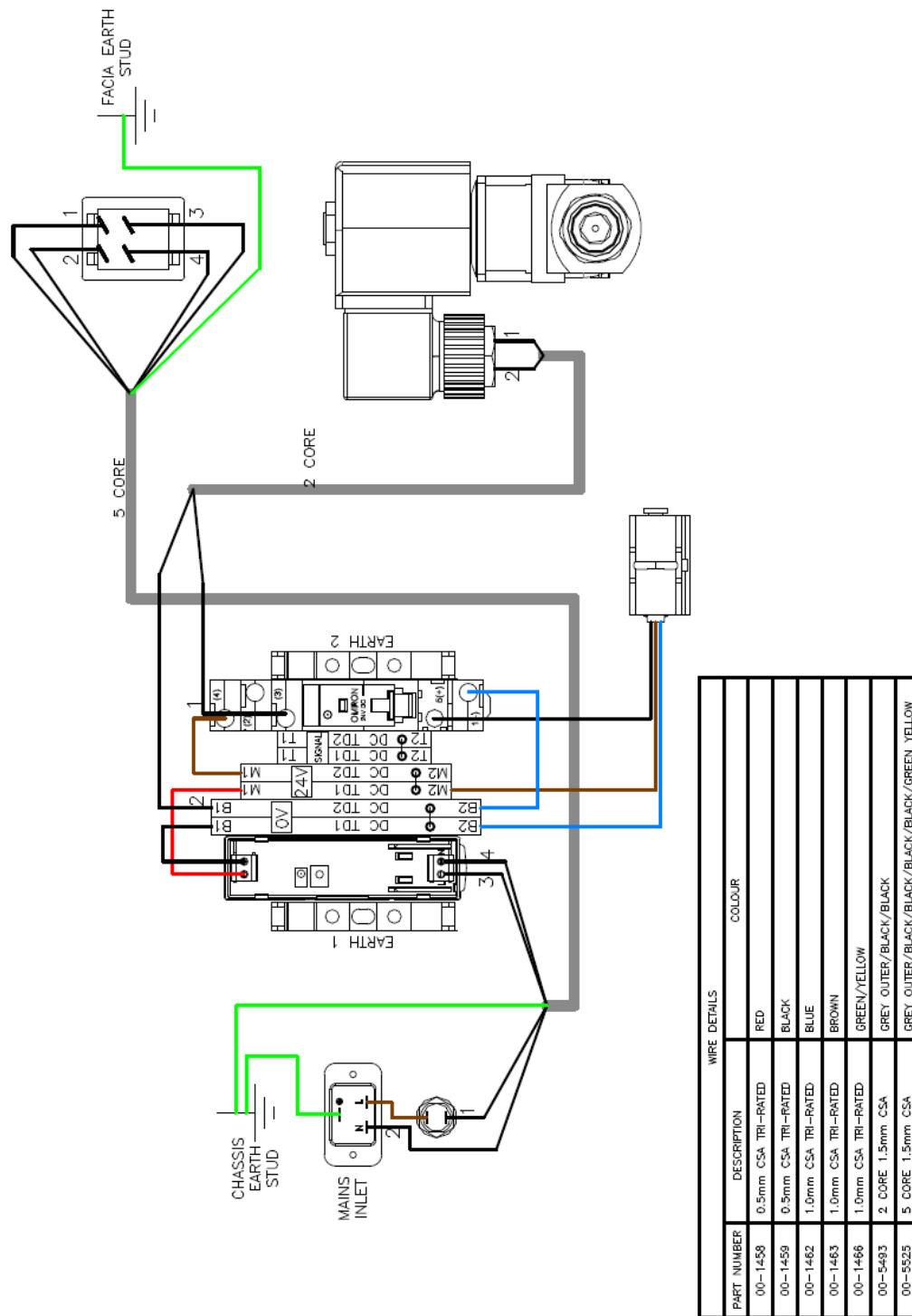

Peak Scientific UK

Fountain Crescent
Inchinnan Business Park
Inchinnan
PA4 9RE
Scotland, UK

Tel: +44 (0)141 812 8100
Fax: +44 (0)141 812 8200

Peak Scientific Germany

Herriotstrasse 1
60528 Frankfurt

Germany

Tel: +49 (0)69 677 33 490
Fax: +49 (0)69 677 33 200

Peak Scientific Taiwan

4F.-6, No.736
Zhongzheng Rd.
Zhonghe Dist.
New Taipei City

Tel: +886 2 8226 2383
Fax: +886 2 8226 9499

Peak Scientific North America

19 Sterling Road
Suite #1
Billerica, MA 01862

USA

Tel: +1 866 647 1649
Fax: +1 978 608 9503

Peak Scientific China

Room 606 Building 1
Lane 2277 Zuchongzhi Road
Pudong New Area
Shanghai
201203, China

Tel: +86 21 5079 1190
Fax: +86 21 5079 1191

Peak Scientific Brazil

Peak Scientific Brasil
Av. Quieroz Filho
1700 – torre Sunny-Conj. 602
São Paulo SP Brasil

Tel: +1 866 647 1649

Peak Scientific India

202, Amsri Shamira
Old Lancer Line
Opp. St. Mary's Degree College
S.D. Road Secunderabad
500 025, India

Tel: +91 40 2780 0663
Fax: +91 40 2780 0663

Peak Scientific Mexico

Solon 352
Col. Los Morales Polanco
11530 Mexico, D.F.

Mexico

Tel: +1 866 647 1649
Fax: +1 978 608 9503

Peak Scientific Japan K.K.

2-7-56, 2F Fuji Building 28
Kita Aoyama, Minato-Ku
Tokyo, Japan
107-0061

Tel: +81 3-6864-0468

Peak Scientific Africa

PO Box 478
Somerset Mall
7137

South Africa

Tel: +27 (0)2185 16542
Fax: +27 (0)8654 64473

Peak Scientific Australia

PO Box 65
Belmont
Victoria 3216

Australia

Tel: +61 1300 965 352

Peak Scientific Singapore

3 Science Park Drive
#03-14 The Franklin
Science Park Drive 1
Singapore, 118223

Tel: +65-6777 1966
Fax: +65-6777 1978