

Tips on Making your GC System and Analysis more Robust

Primary Areas of Concern

- Sample
- Auto-Injector
- Inlet
- Column
- Detector

Sample Preparation and Care

It is critical that the sample extract be handled in the most consistent manner possible with regard to the following variables:

- Temperature
- Vial seal integrity
- pH
- Solvent purity
- Exposure to light

Auto-Injector Setup

5uL syringe vs. 10uL syringe

Solvent washes before and after injection

Sample washes before injection

Sample pumps prior to injection

Plunger speed?

Viscosity delay?



Typical Auto-Injector Setup

10- μ L syringe with HP-Point

Use Agilent Certified Vials

3-5 sample pumps

3 washes with solvents A and B
pre and post injection:

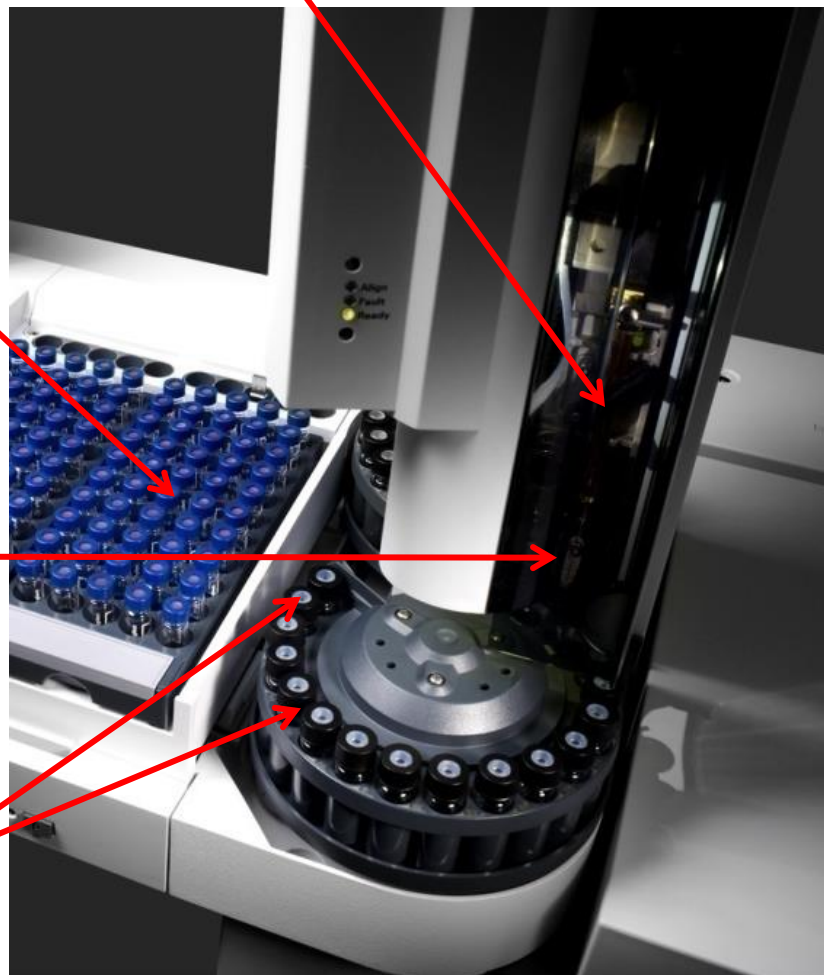

GC Surfaces that Samples Contact

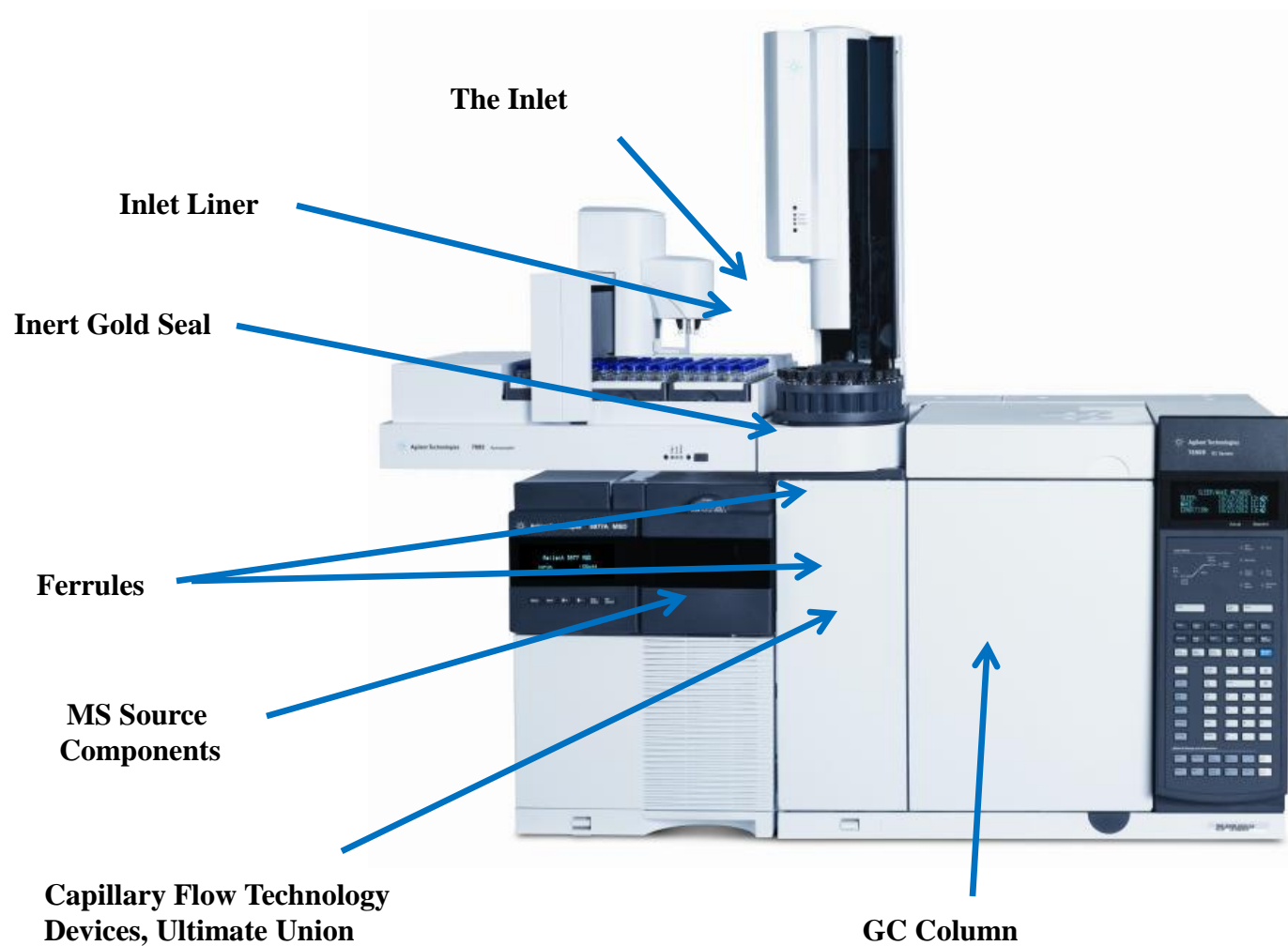

Agilent Inert Flow Solution



Ultra Inert Inlet Liner

Deactivated Inlet Weldments, Shell and Transfer Lines



Deactivated – FPD

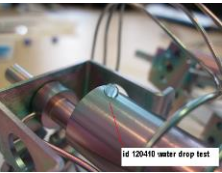

Flexible Metal Ferrules

350 Ultra Inert source



Ultra Inert Gold Seal



Ultra Inert GC Column

Deactivated Capillary Flow Technology Devices



Inlet Considerations

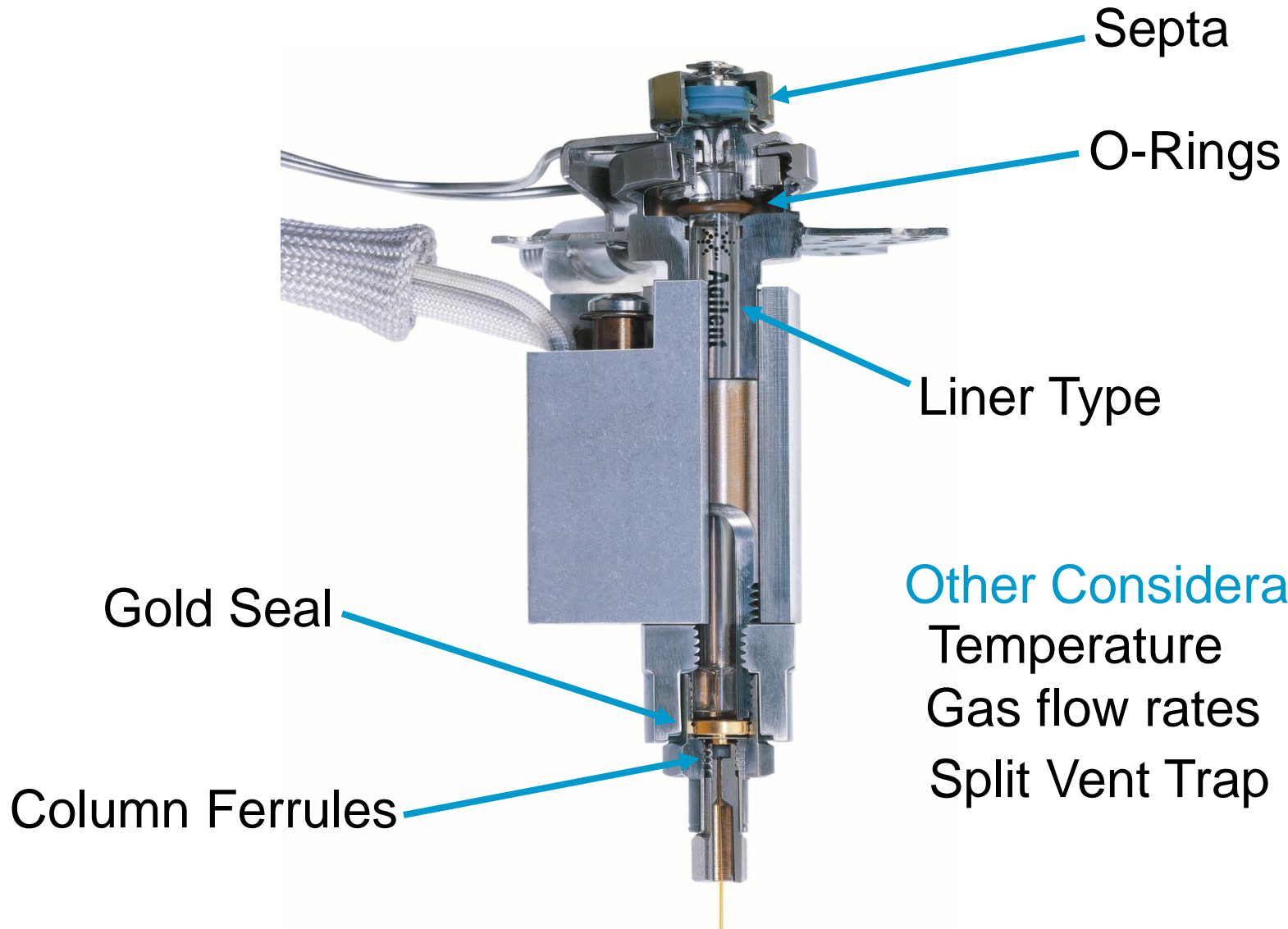

Preferred Inlet Septa

Use Bleed and Temperature Optimized (BTO) septa for inlet temperatures up to 400°C

Use Advanced Green septa for inlet temperature up to 350°C

The dimpled CenterGuide on Agilent septa greatly reduces coring related leak problems



CenterGuide Septum

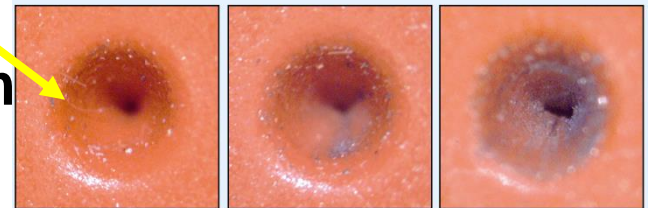
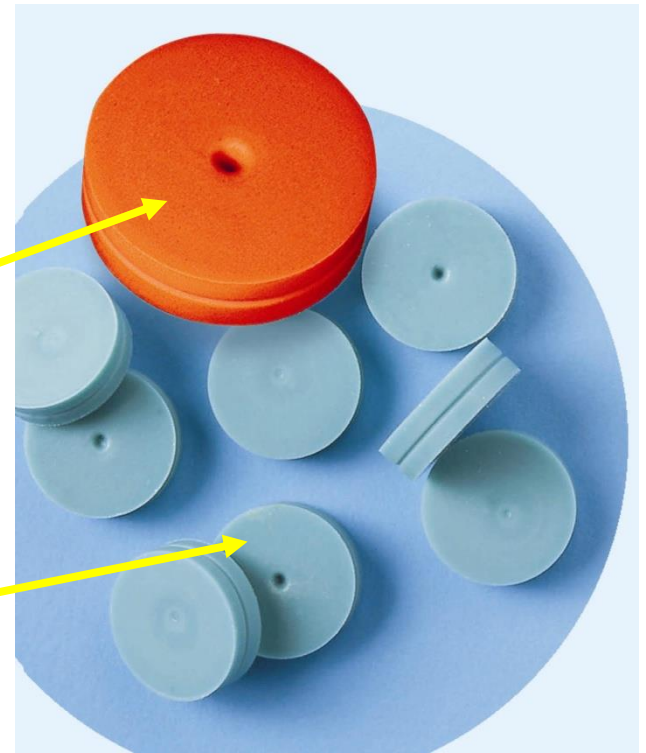

1 Injection

100 Injections

700 Injections

Septa vs GC Column Costs

Typical cost of 1 Premium Septum (list), **\$1.50**

Typical cost of 1 GC Column, 30 m x 0.25 mm ID, **\$500.**

Leaks affect flow rates causing inaccurate results.

“Don’t step over a dollar to pick up a dime!”

Proactively change inlet septa.

Liners - 3 Key Variables

Liner Volume

Liner Treatments or Deactivation

Special Characteristics (glass wool, cup, taper, etc.)

When choosing a liner for your application, consider all three aspects to give you the best chromatography.

You must also determine what type of inlet is in your GC

Then consider the application itself, and the types of liners and injection techniques used for it:

Split/Splitless

On-Column

Programmable Temperature

MultiMode (MMI)

Purge-Packed

Vaporization (PTV)

Inlet Liners – Volume Considerations

Glass Inlet Liners provide an “inert” space for liquid samples to be uniformly vaporized to a gas and moved to the column.

Liquid-gas phase change involves a significant change in volume.

Gaseous sample volume depends on

- Injection volume
- Solvent type
- Column head pressure
- Inlet temperature

These aspects should be optimized for your sample volume and application.

<u>Solvent</u> <u>(1μL, ambient)</u>	<u>Volume</u> <u>(μL at 250°C and 20psig)</u>
n-Hexane	140
Acetone	245
Acetonitrile	350
Methanol	450
Water	1010

See “A Practical Guide to the Care, Maintenance, and Troubleshooting of Capillary GC Systems”, Third Revised Edition, by Dean Rood, Wiley-VCH, New York, 2001.

Liner Volume

Choose a liner with enough volume to accommodate the vaporized sample.

Important, especially for polar solvents with large vapor volumes.

If vapor volume of sample exceeds liner volume, samples may back up (backflash) into carrier gas supply lines, causing ghost peaks and reproducibility problems in chromatography.

Agilent liners are primarily 2mm or 4mm in inner diameter (without tapers and additional features) and 78mm long.

- 2mm liners hold approx. 0.245 mL or 245 μ L of vapor
- 4mm liners hold approx. 0.972 mL or 972 μ L of vapor

Liner Volume (contd.)

Recommended injection volumes are 1-2uL or less for organic solvents, 0.5uL for water.

Try user-contributed GC Pressure/Flow/Vapor Volume calculator to calculate the vapor volume for a liquid solvent in a given inlet liner, based on solvent, inlet temperature, and pressure.

<https://www.agilent.com/en-us/support/gas-chromatography/gccalculators>

Or, Google: “agilent pressure flow calculator”

Vapor Volume Calculator Software

Hexane Looks Good

The screenshot displays the 'Vapor Volume Calculator' software interface. The window title is 'Vapor Volume Calculator'. The interface is divided into several sections:

- Solvent Properties:** A dropdown menu shows 'Hexane'. Below it, the following properties are listed:
 - Boiling Point (°C) : 68.7
 - Density (g/cm³) : 0.659
 - Mol Wt. (amu) : 86.2
- Injection Liner:** A dropdown menu shows '5183-4647 single-tapered s...'. Below it, the Liner Volume (µL) is 850.
- Injection Parameters (highlighted with a blue box):**
 - Injection volume (µL):** A slider and a numeric input field set to 1.00.
 - Inlet Temperature (°C):** A slider and a numeric input field set to 250.
 - Inlet Pressure (gauge):** A slider and a numeric input field set to 10.000.
 - Units: Radio buttons for kPa, **psi** (selected), and bar.
- Results:**
 - Estimated Volume: **195 µL**
 - % Capacity: **22%**
 - A horizontal bar chart shows a green segment representing 22% of the total capacity.
- Solvents:** Buttons for 'Add', 'Remove', and 'Defaults'.
- Liners:** Buttons for 'Add', 'Remove', and 'Defaults'.

Vapor Volume Calculator Software

Water Can Be Trouble

Vapor Volume Calculator

Liner capacity exceeded! Choose a liner of greater volume or modify method parameters.

Solvent Properties

Water

Boiling Point (°C) : 100

Density (g/cm³) : 0.998

Mol Wt. (amu) : 18.02

Injection Liner

5183-4647 single-tapered sy

Liner Volume (μL) : 850

Injection volume (μL)

1.00

Inlet Temperature (°C)

250

Inlet Pressure (gauge)

10.000

kPa psi bar

Estimated Volume

1414 μL

% Capacity

166%

Solvents

Add Remove Defaults

Liners

Add Remove Defaults

Pressure/Flow Calculator Software

Water– Reduce Injection Volume

Vapor Volume Calculator

Solvent Properties

Water

Boiling Point (°C) : 100

Density (g/cm³) : 0.998

Mol Wt. (amu) : 18.02

Injection Liner

5183-4647 single-tapered syringe

Liner Volume (µL) : 850

Injection volume (µL)

0.50

Inlet Temperature (°C)

250

Inlet Pressure (gauge)

10.000

kPa psi bar

Estimated Volume

707 µL

% Capacity

83%

Solvents

Add Remove Defaults

Liners

Add Remove Defaults

Pressure/Flow Calculator Software

Water– Increase Inlet Pressure

Vapor Volume Calculator

Solvent Properties

Water

Boiling Point (°C) : 100

Density (g/cm³) : 0.998

Mol Wt. (amu) : 18.02

Injection Liner

5183-4647 single-tapered syringe

Liner Volume (μL) : 850

Injection volume (μL)

1.00

Inlet Temperature (°C)

250

Inlet Pressure (gauge)

40.000

kPa psi bar

Estimated Volume

638 μL

% Capacity

75%

Solvents

Add Remove Defaults

Liners

Add Remove Defaults

Liner Treatments or Deactivation

Minimizes possibility of active sample components from adsorbing on active sites on the liner or glass wool surface.

Unwanted sample adsorption leads to tailing peaks and loss of response for active analytes.

Although not necessary for all applications, deactivated liners provide added insurance against possible sample adsorption.

Deactivation of borosilicate glass liners is often done with a silylating reagent like Dimethyldichlorosilane (DMDCS) or by coating with a siloxane (as capillaries are made).

Special Characteristics

Some liners have special features that are necessary for different injection techniques. For example:

Taper (gooseneck), minimizes sample contact with gold seal.

Dual taper, also minimizes sample contact with inlet weldment and reduces potential for backflash.

Glass wool and shelf to hold it in place, prevents non-volatiles from reaching column and removes residual sample from needle. Glass wool should be deactivated.

Jennings cup, normally used for efficient sample mixing in split inlets, reduces sample discrimination and prevents non-volatiles from reaching the column. Not for very dirty samples.

Press fit (direct) connection end to hold capillary column firmly (virtually all sample goes onto the column). Side hole needed for Electronic Pressure Control with direct connect liners.

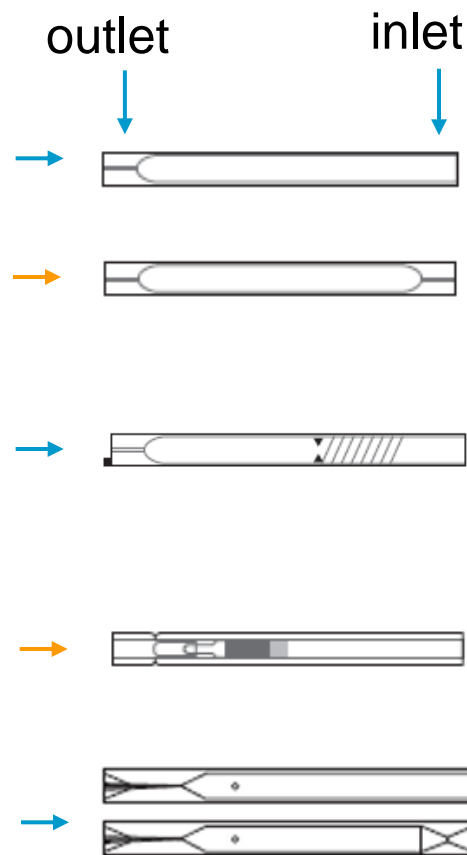





Split Injection Overview

- Most common injection technique
- Reduces the amount of sample that reaches the column (majority of sample exits the inlet via the split vent)
- Used primarily for highly concentrated samples (0.1 – 20mg/mL) and large sample volumes (up to 4 μL) .
- Highly efficient injection technique
- Must be inserted in inlet so bottom does not contact gold seal (need carrier flow access to split vent)



Split Injection Liners





Liner	Part No.	Comments
	5190-2294	Simplest split liner, glass wool, UI deactivation, large volume, 990 μ L volume. Use for general purpose. Also used for Splitless mode.
 <p data-bbox="144 699 338 735">Glass nub</p>	5190-2295	Glass wool (held near needle entrance to remove residual sample on needle), deactivated, 870 μ L volume. Glass nub ensures that gap remains below liner for split injection. Efficient, for most applications, including active compounds. Fail-safe insertion into injection port. Needle length is important.
	18740-80190	Liner with Jennings cup, no glass wool, 800 μ L volume. Use for general purpose applications, high and low MW compounds. Reduces inlet discrimination.
	18740-60840	Liner with Jennings cup, glass wool, and column packing, 800 μ L volume. For dirty samples, traps non-volatiles and particulates well. For high and low MW compounds. Not recommended for use with EPC.

Splitless Injection Overview

For Trace Level Analysis

- Use split/splitless injection port in the splitless mode (split vent closed).
- The dilute sample is injected, the sample is volatilized, and majority of analytes condense on column.
- Later, the split vent is opened and residual solvent is vented.
- Timing, carrier and split vent flows, and oven temperature program are important.
- Sample has longer residence time in the heated inlet giving more opportunity to vaporize high boiling sample components compared to split injection.

Splitless Injection Liners

Liner	Part No.	Comments
	5190-2292	Single taper, deactivated, 900µL volume. Taper isolates sample from metal seal, reducing breakdown of compounds that are active with metals. For trace samples, general application.
	5190-2293	Single taper, deactivated, with glass wool, 900µL volume. Glass wool aides volatilization and protects column. For trace (dirty) samples.
	5190-3983	Double taper, deactivated, 800µL volume. Taper on inlet reduces chance for backflash into carrier gas lines. High efficiency liner for trace, active samples.
	G1544-80730 G1544-80700	Direct connect liners, single and dual taper, deactivated. Capillary column press fits into liner end, eliminating sample exposure to inlet. Ultimate protection for trace, active samples. Side hole permits use with EPC.

Liner Maintenance

Liners become contaminated with use, collecting non-volatiles, salts, excess reagents, etc., or become damaged/cracked.

Should inspect and replace liners often.

Handle with gloves and forceps.

Insert into or remove liners only from cool injection ports.

Replacing with a new liner is recommended, to ensure reproducibility



Liner Maintenance (contd.)

Advantages of cleaning liners yourself:

- Reduced cost

Disadvantages:

- Time-consuming
- Liners with special features (glass wool, cup, etc.) are difficult to clean
- Reproducibility of liner is compromised
- Removing or inserting glass wool may create significant active sites in glass

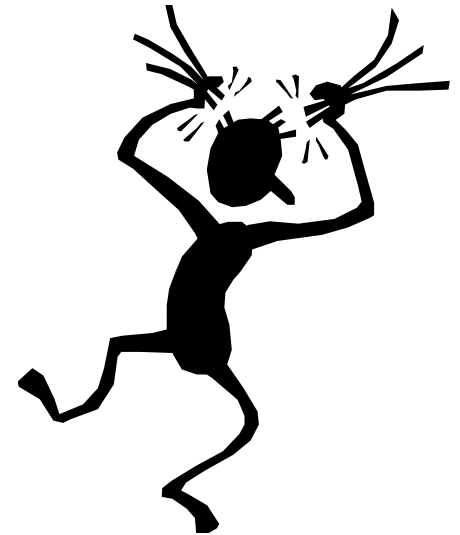

Best advice -- keep a supply of new liners on-hand!

Liner Troubleshooting

Many chromatographic problems are blamed on the column.

Often, a dirty liner is the culprit.

Symptoms include:

- Poor peak shape
- Irregular baselines
- Poor resolution
- Poor response

Do liner types really matter?

They do, especially for active compounds like:

- phenols
- organic acids
- pesticides
- amines
- drugs of abuse, etc.

Phenols, for example....in a separation of EPA method 8270 compounds

Cool On-Column-FID Injection of 11 Analyte Test Mix

From "Improvements in the Agilent 6890/5973 GC/MSD System for Use with USEPA Method 8270", Agilent Application Note 5988-3072EN

- 1 N-Nitrosodimethylamine
- 2 Aniline
- 3 2,4-Dinitrophenol
- 4 4-Nitrophenol
- 5 4,6-Dinitro-2-methylphenol
- 6 4-Aminobiphenyl

- 7 Pentachlorophenol
- 8 Benzidine
- 9 3,3-Dichlorobenzidine
- 10 Benzo(b)fluoranthene
- 11 Benzo(k)fluoranthene

- ISTD 1 Dichlorobenzene-d4
- ISTD 2 Naphthalene-d8
- ISTD 3 Acenaphthene-d10
- ISTD 4 Phenanthrene-d10
- ISTD 5 Chrysene-d12
- ISTD 6 Perylene-d12

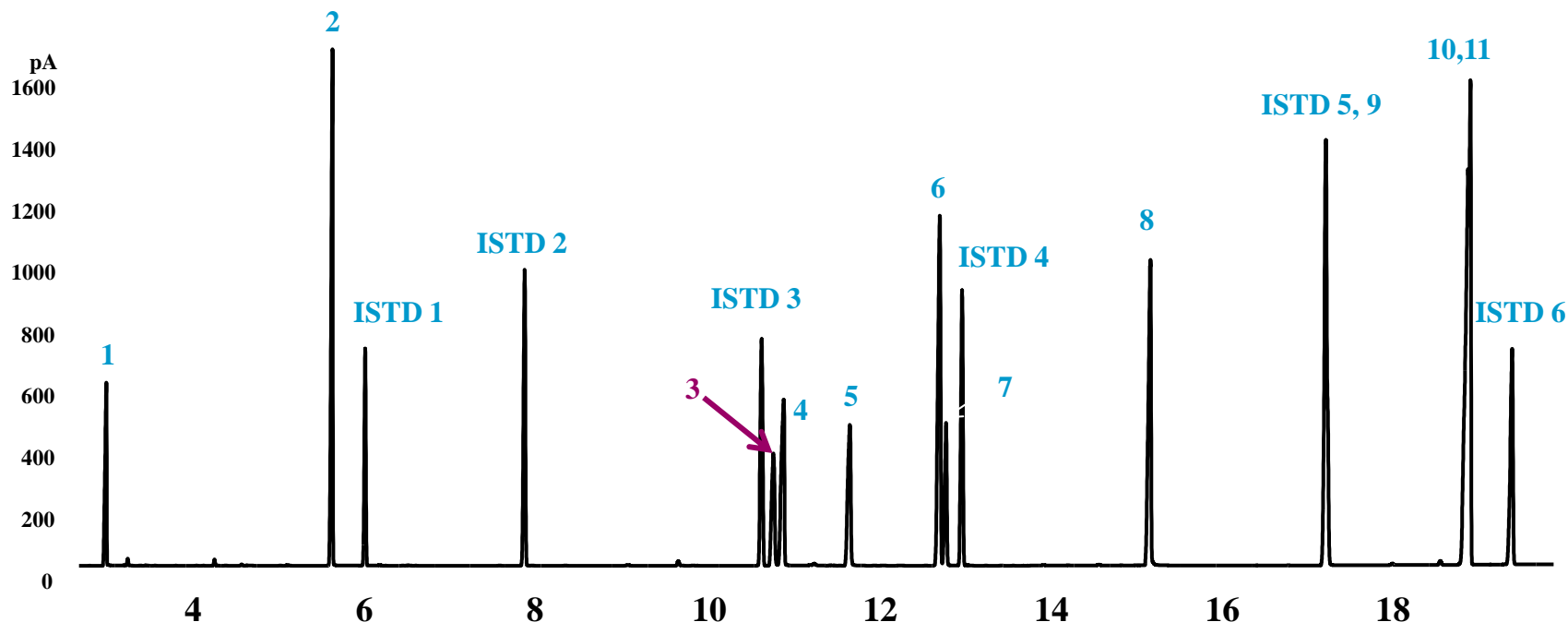

Liner Conclusions

Agilent inlet liners can be used with a broad range of samples and analytes and chromatographic response depends heavily on liner type.

To choose a liner, first consider:

- Type of inlet in your GC
- Concentration and type of sample
 - high conc. - use Split
 - trace analytes - use Splitless or PTV
 - broad range - use Split/Splitless or PTV – general purpose
 - heat-sensitive and high boiling point compounds - use On-Column or PTV

Liner Conclusions (contd.)

Next, consider

- Sample size, solvent, cleanliness, and potential analyte activity - helps to choose special liner features (cup, wool, taper, etc.) and liner volume that are necessary for your application.

Finally, optimize chromatographic conditions for the best separation.

Remember to check liner condition often and replace when necessary to minimize downtime.

Good chromatography starts with the inlet. Choose the correct liner for your application.

Examples of Non-Optimized Operation



Typical Cause—Re-use and mis-installation.



- Leak from O-ring, Gold Seal, ferrules, column nuts
- O-rings are elastomer compression fittings designed for one use, not perfectly elastic.
- Gold seals are designed for one use, knife edge cuts into gold layer giving leak tight seal w/o shrinkage or potential organic contaminants from polyimide out-gassing/degradation.
- Re-using could result in overlap in seal rings, resulting in a leak.

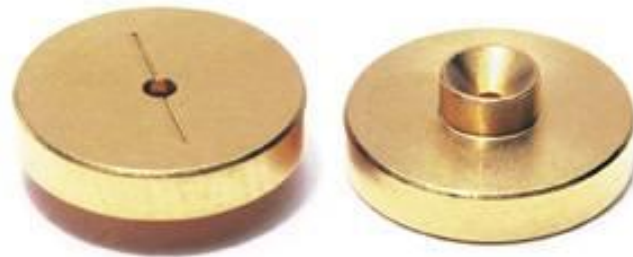
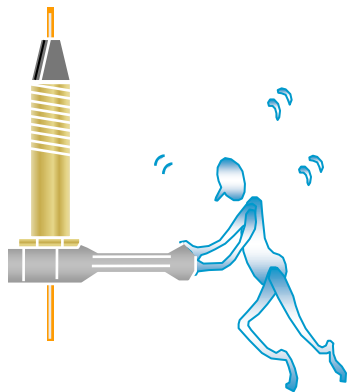

SPLIT VENT TRAP

Located behind the inlets,
under the back cover.

A dirty split vent trap can
affect the way that the flow
goes through the inlet.



7 Remove the old filter cartridge and two O-rings.

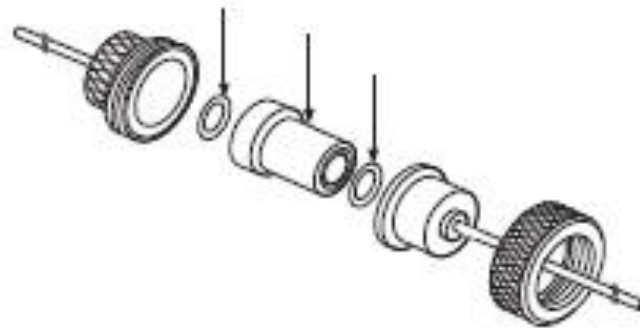

Column Installation Procedure

- Install the column
- Leak and installation check
- Column conditioning
- Setting linear velocity or flow rate
- Bleed profile
- Test mix (standard)

Column Installation

What type of ferrule should I use?

- Graphite
- Graphite/Vespel

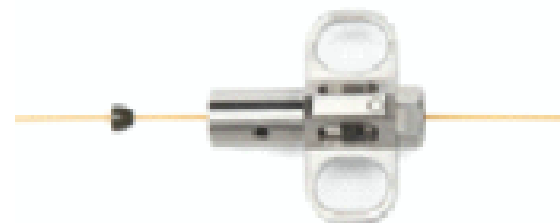

Column Installation

Measuring the right distance

White out

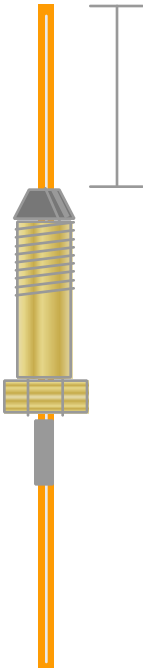

Septa

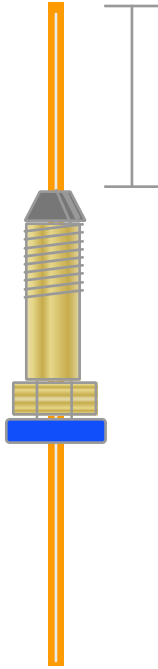

Cutting The Column

Gently scribe through the polyimide coating.
Do not attempt to cut the glass.

Recommended tools:

Diamond or carbide tipped pencil; or sapphire cleaving tool, ceramic wafer
Ocular

Do not use:

Scissors, file, etc.

Example of a Bad Cut

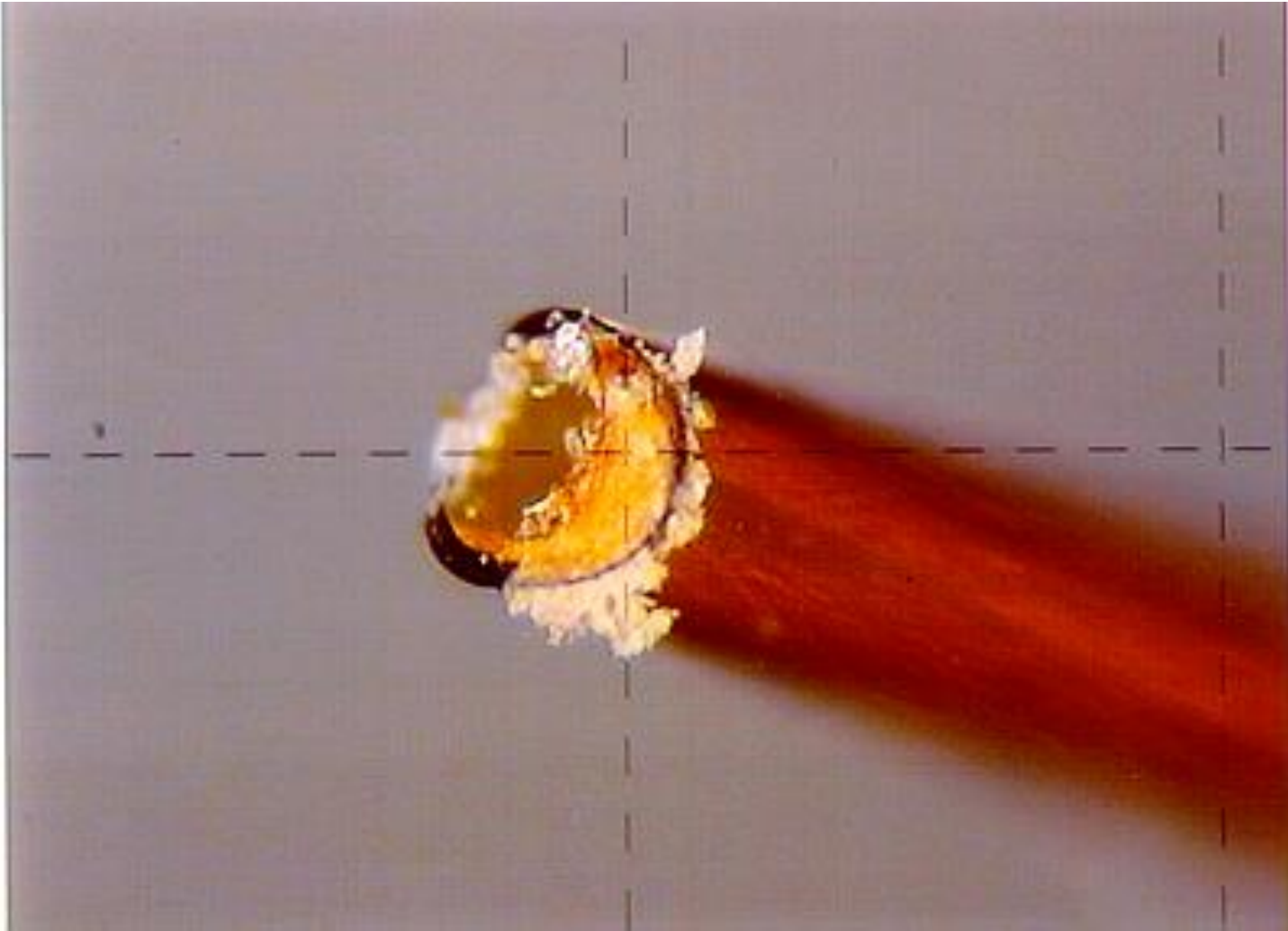

Examples of Column Cuts

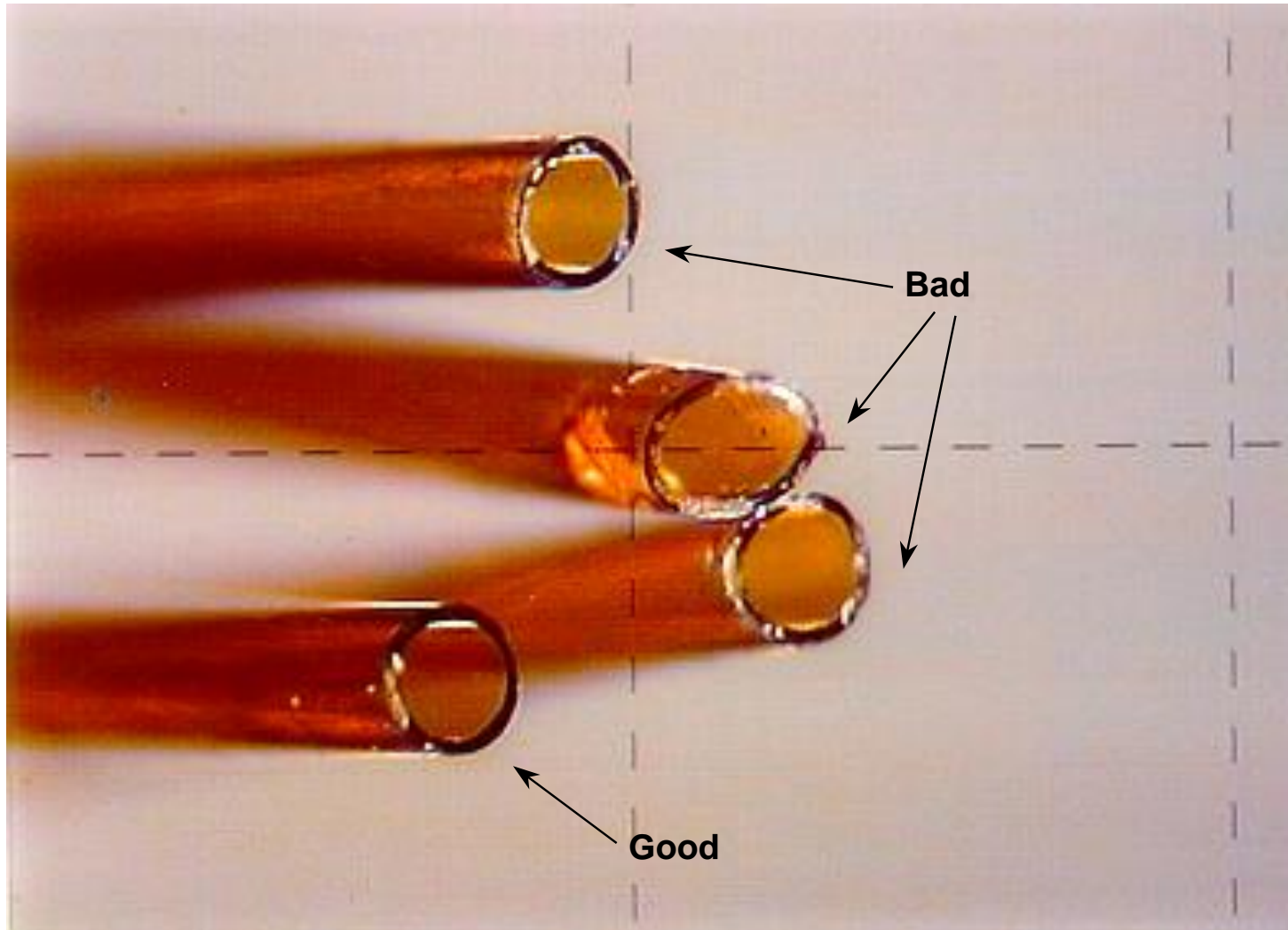

Column Installation

How tight is tight?

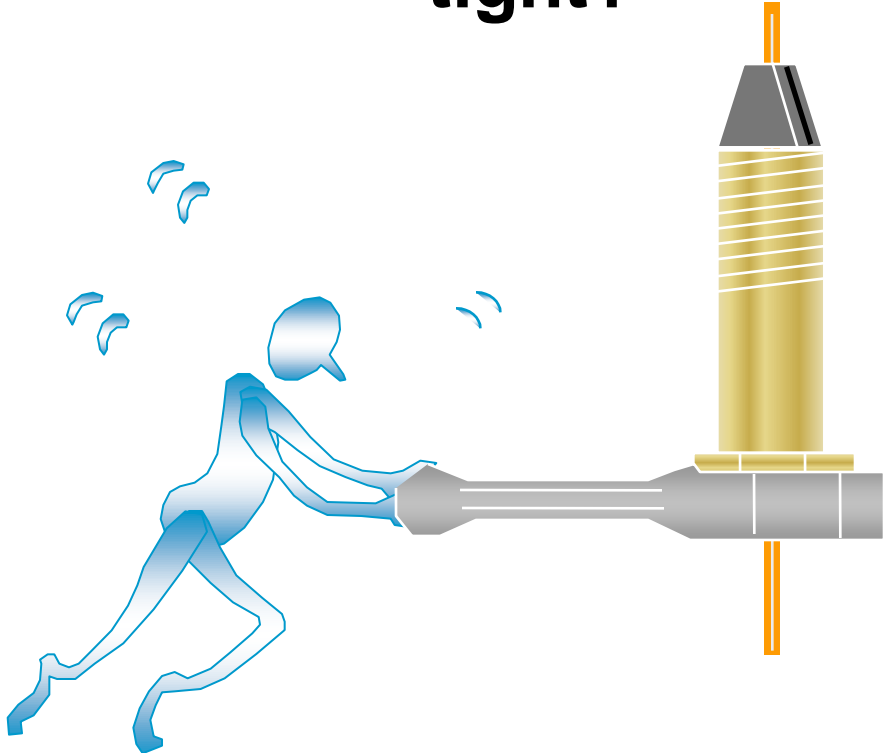

Overtightened Ferrule

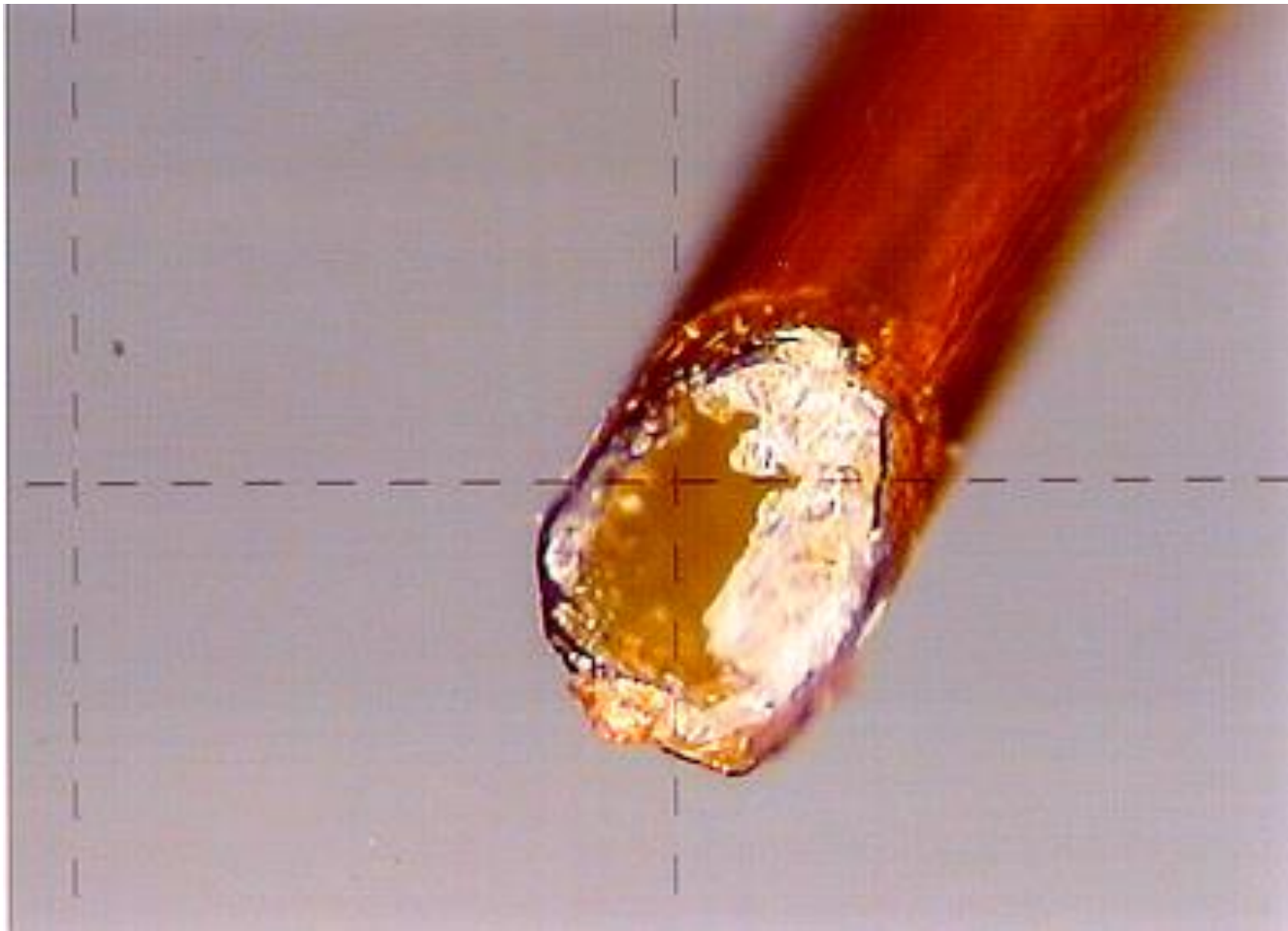

Column Installation

Leak Check

DO NOT USE SNOOP

Electronic leak detector

IPA/Water

Inject a non-retained peak

Leak and Installation Check

Inject a non-retained compound WCOT column

Detector	Compound
FID	Methane or Butane
ECD	MeCl ₂ (headspace or diluted)
NPD	CH ₃ CN-acetonitrile (headspace or diluted)
TCD	Air
MS	Air or Butane

The peak should be sharp and symmetrical

Non-Retained Peak Shapes

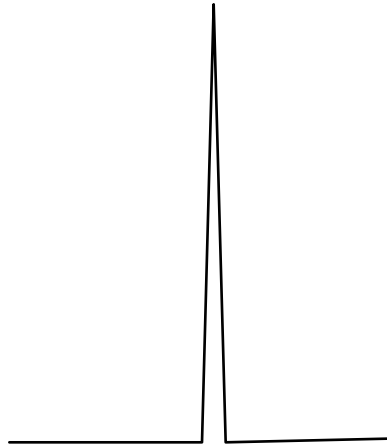

Good Installation

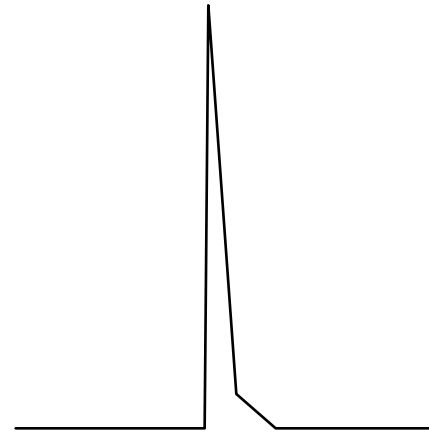

Improper Installation or
Injector Leak

- Check for:
- Too low of a split ratio
 - Injector or septum leak
 - Liner problem:
(broken, leaking, misplaced)
 - Column position in injector and detector

Calculating Linear Velocity

Inject a non-retained compound and obtain the retention time:

$$\bar{\mu} = \frac{L}{t_0}$$

$\bar{\mu}$ = Average linear velocity (cm/sec)
 L = Column length (cm)
 t_0 = Retention time (sec)

He 20-40 cm/sec
H₂ 35-55 cm/sec

$\bar{\mu}$ is dependent on column temperature

Calculating Flow Rate

Inject a non-retained compound and obtain the retention time:

$$\bar{F} = \frac{\pi r^2 L}{t_0}$$

\bar{F} = Flow rate (mL/min)

r = Column radius (cm)

L = Column length (cm)

t_0 = Retention time (sec)

\bar{F} is dependent on column temperature
Measuring flow with a flow meter is often
inaccurate

Column Conditioning

System must be leak free before conditioning column

Heat the column to the lower of:

Isothermal maximum temperature OR

20° to 30°C above highest operation temperature

Temperature programming is not necessary

Stop conditioning when the stable baseline is obtained:

1 to 2 hours in most cases

What Is Normal Column Bleed?

Normal background signal generated by the elution of normal degradation products of the column stationary phase



Column Bleed Is Influenced By:

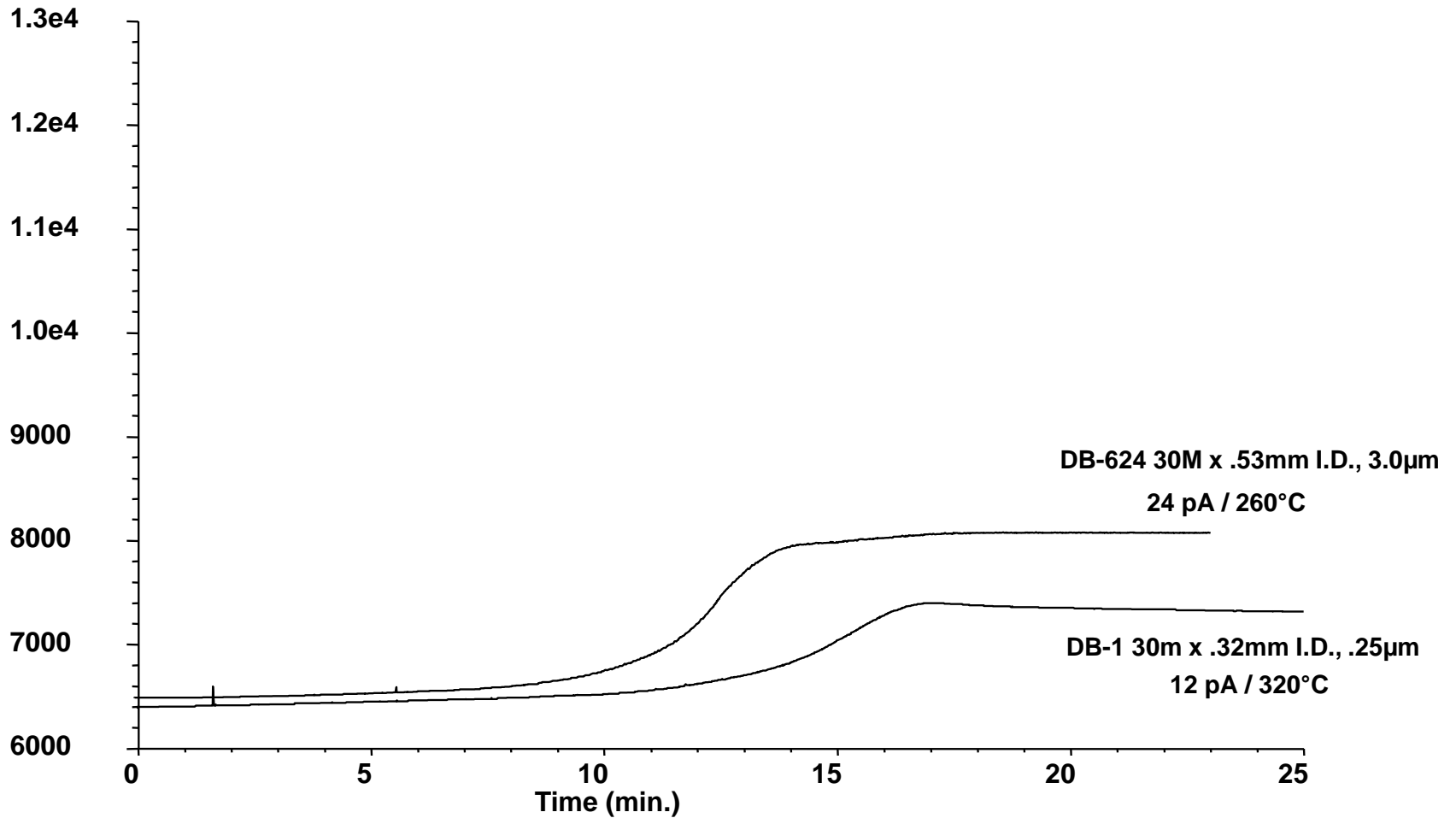

What Is A Bleed Problem?

An abnormal elevated baseline at high temperature

IT IS NOT

A high baseline at low temperature

Wandering or drifting baseline at any temperature

Discrete peaks

Example Of Column Contamination

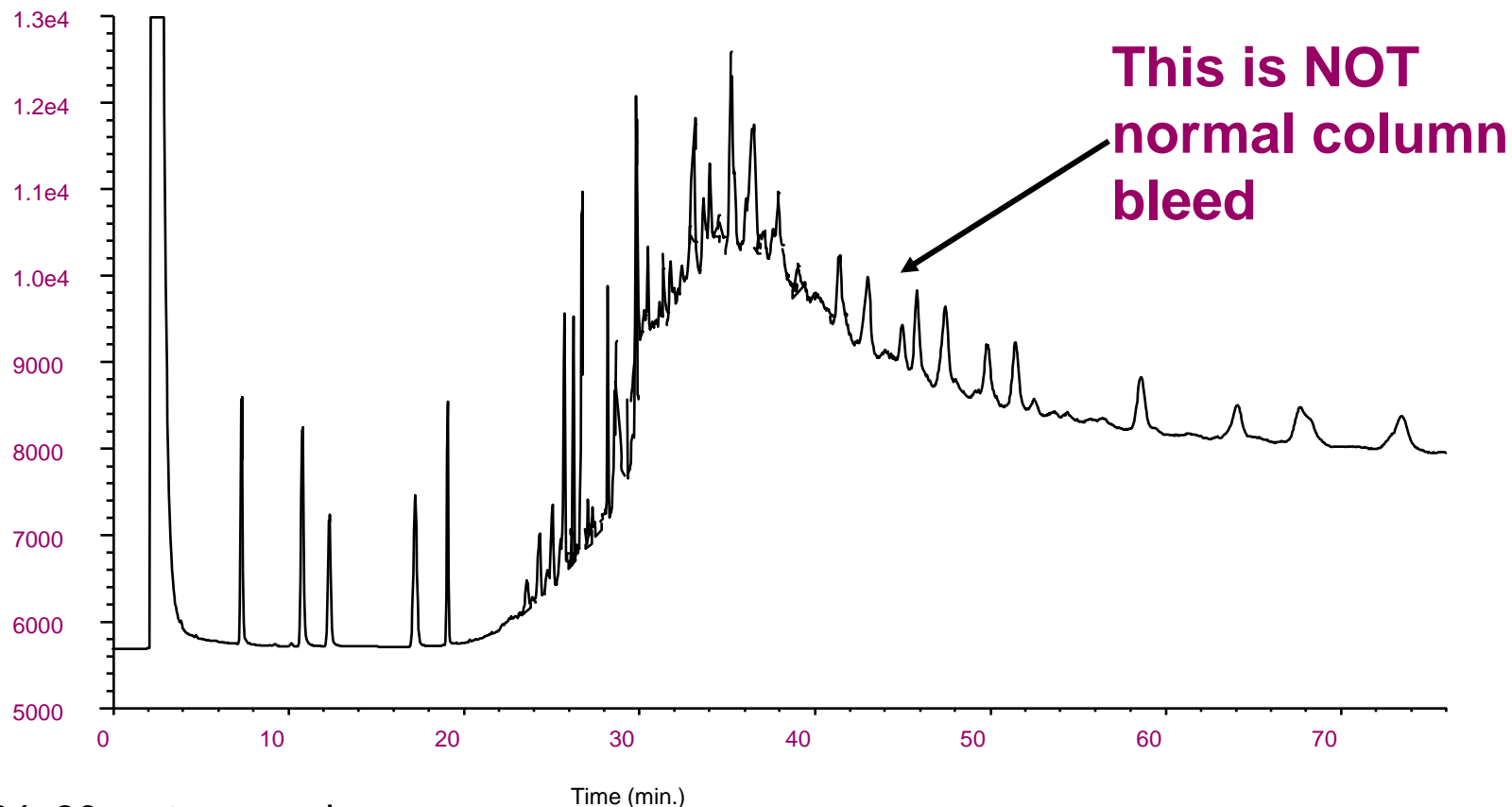

DB-624, 30 meter megabore

Temperature program // 35°C, hold 1.50 min // 30°/min to 65°C,

hold 15 min // 20°/min to 260°, hold 50 min

Same Column After Inlet And Column Maintenance

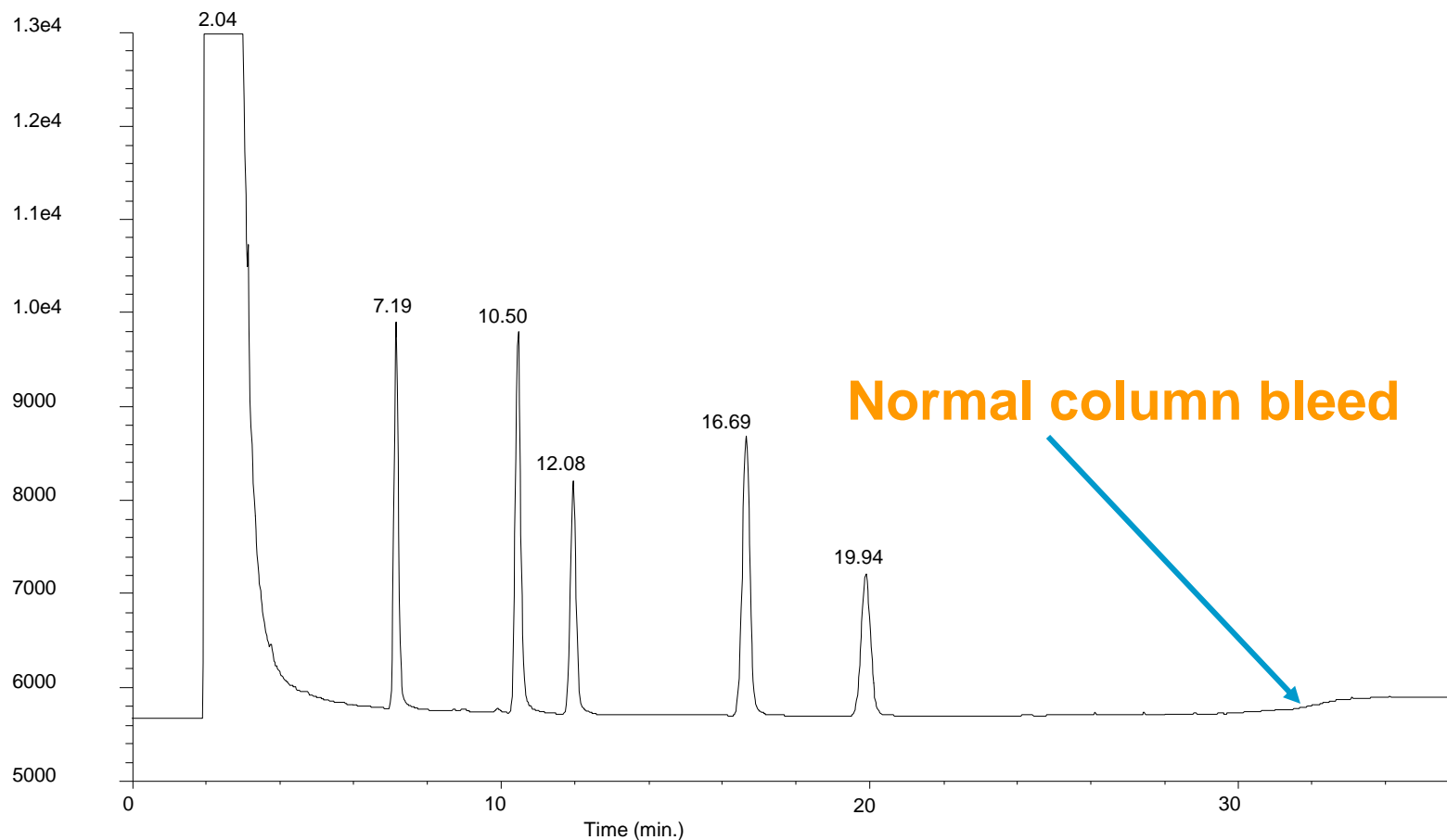

*Temperature program // 35°C, hold for 1.50 min // 30°/min to 65°C, hold 15 min // 20°/min to 260°C for 5 min

GC Column Advances

Last several years have seen modest advances in GC column technology

- Column bleed
- Custom columns
- Customized stationary phases
- Application specific columns
- High temperature phases including Sol-gel phases
- Dependability and reproducibility
- Ultra Inert
- Longer Life?????

Column Contamination

- Fouling of GC and column by contaminants
- Mimics nearly every chromatographic problem

Symptoms of Contamination

- Poor peak shape
- Loss of separation (resolution)
- Changes in retention
- Reduced peak size
- Baseline disturbances (semi-volatiles only)

Typical Samples That Contain a Large Amount of Residues

Biological (Blood, Urine, Tissue, Plants)

Soils

Foods

Waste Water

Sludges

All samples contain residues!! (even standards!)

Other Sources of Contamination

- Septum and ferrule particles
- Gas and trap impurities
- Unknown sources (vials, syringes, etc.)

Non-Volatile Residues

Any portion of the sample that does not elute from the column or remains in the injector.

Semi-Volatile Residues

Any portion of the sample that elutes from the column after the current chromatographic run.

Methods to Minimize Non-Volatile Residue Problems

- Sample cleanup
- Packed injection port liners
- Guard columns

Guard Column or Retention Gap

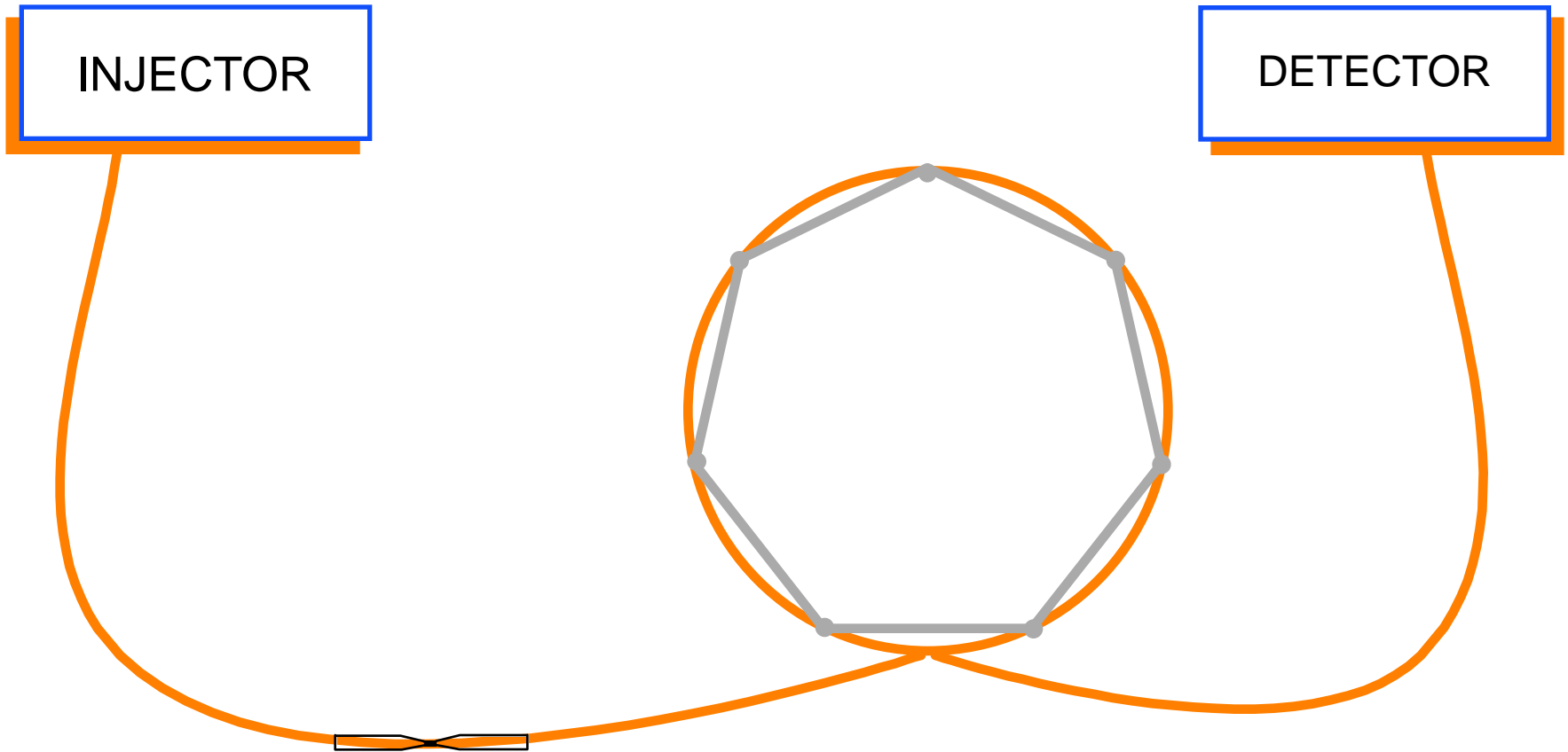

The guard column is 3 - 5 meters of deactivated fused silica tubing with the same diameter as the analytical column. It is connected with a zero dead volume union.

Column Connectors



Non-Volatile Contamination

What To Do If It Happens

- Do not “bake out” the column
- Front End Maintenance
 - clean or change the injector liner
 - clean the injector
 - cut off 1/2 -1 meter of the front of the column
- Turn the column around
- Solvent rinse the column
- Cut the column in half

What Should You Look For In a Quality GC Column?

How demanding are the test probes?

Do the probes used in the QC test emulate your analyses?

When looking at a “replacement” column for existing methods on a different column brand, does the manufacture’s test adequately test the stationary phase functionality (selectivity, film thickness)

What temperature is the test performed? Isothermal or programmed?

What Should You Look For In a Quality GC Column?

If bleed is measured/stated, how and at what temperature was it measured?

If comparing two columns, remember “don’t mix apples and oranges” when drawing conclusions.

Everything looks the same “from the cheap seats”, so take a close up look at small pictures in brochures and advertisements

Detector Considerations

The primary variables to focus on with the detector are:

Temperatures

Flows

General preventative maintenance



Conclusion

- ✓ Maximize consistency of sample stability by minimizing handling variance
- ✓ Develop methods using the correct inlet and auto-injector parts, including septa, syringes, ferrules, O-Rings and most importantly, inlet liners
- ✓ Choose capillary GC columns based on performance and true quality testing
- ✓ When changing a column, make sure to 'measure' the linear velocity or volumetric flow

Conclusion

- ✓ Follow a regular routine of inlet, column and detector preventative maintenance
 - ✓ When you replace a liner, trim the column
- ✓ Keep an accurate instrument record with all settings documented and all maintenance logged for future reference

Agilent GC Column Technical Support

800-227-9770 (phone: US & Canada)*

- *Select option 3...3...1*

866-422-5571 (fax)

gc-column-support@agilent.com

