

Technical Report

An Improvement in Preparative SFC Efficiency Utilizing Online SFE-SFC System as a "Solid Autosampler"

Takuya Yoshioka¹, Chihiro Kora¹, Keiko Matsumoto¹, Yasuhiro Funada¹

Abstract:

Preparative SFC is a groundbreaking separation and purification technology. It has a number of advantages in comparison to preparative LC including simplified posttreatment, shorter analysis times, and different separation selectivity. With preparative SFC, the injection of large sample volumes is often required in order to increase the recovered amount. If the injection volume is simply increased, however, peak shapes worsen from the impact of the sample solvent, raising concerns about separation failures. In order to avoid this, a way is needed to enable large-quantity sample injections without increasing the impact of the sample solvent. Here, we introduce the "solid autosampler" technique using online SFE-SFC system, which allows for the introduction of solid samples without dissolving them. In the online SFE-SFC system, the target compounds in the sample are extracted with supercritical CO₂ which is a weak solvent within the SFE unit, and the extract is then introduced into the SFC system online. The target compounds dissolved in the weak solvent can be injected in large quantities while maintaining the peak shape. This is expected to shorten the time required for recovery of the target compounds and to decrease the consumption of solvents.

Keywords: Online SFE-SFC system, Solid autosampler

1. Issues with Preparative Chromatography

Purification techniques are required in a variety of fields involving the search for useful compounds, the analysis of impurities in pharmaceuticals, and chemical synthesis. Preparative liquid chromatograph (LC) and preparative supercritical fluid chromatograph (SFC) are mainly used. With preparative SFC in particular, CO₂ vaporization reduces the volume of the recovered fraction. The amount of water in the recovered fraction is smaller in comparison to reversed-phase liquid chromatography, which simplifies evaporation process. The time required for separation is shorter in comparison to LC, a different separation selectivity from LC is obtained, and there are a number of other advantages. These advantages have led to an increased usage of SFC in recent years. With preparative LC/SFC, the amount of sample to purify is often determined in advance. However, if the total amount cannot be injected with a single injection, repeated injections and fractionation become necessary, which can lead to a drop in the efficiency of purification. In preparative SFC, cases in which the amount injected into the column is limited are shown below.

1) Peak Broadening Due to the Sample Solvent

The simplest method of increasing the recovered quantity of target compounds in a one-cycle purification process is to increase the injection volume. In this case, however, there are concerns about separation failures due to a worsening of the peak shapes. This is because when the injection volume is large, if the sample solution is not sufficiently diluted by the mobile phase, the sample solvent, which has a strong elution capacity, hinders enrichment of the target compounds at the edge of the column. As a result, worsening peak shape is obtained. This phenomenon frequently occurs when the sample solvent is a stronger solvent than the mobile phase (Fig. 1). With preparative LC using reversed-phase chromatography, this peak broadening can be reduced by such as dissolving the sample in water, which is a weak solvent, or co-

injecting the sample solution with water. With preparative SFC however, all solvents are stronger than supercritical CO₂, so a similar avoidance strategy cannot be taken, and the injection volume often cannot be increased.

2) Solubility of Samples

The load quantity in a single injection may be increased by increasing the concentration of the sample solution, but this is limited by the solubility of the sample. Particularly when purifying unknown compounds with unknown physical properties from extracts of vegetation and microorganisms, the sample must be completely dissolved, including the low solubility components, and this tends to result in a low concentration solution.

3) Deposition of Samples

If there is a large difference in solubility between the sample solvent and the mobile phase, when both mix, compounds dissolved in the sample solvent may inadvertently be deposited within the flow lines. In this case, not only costs increase due to instrument maintenance, but precious samples are lost, so the injection volume must be kept low.

This article introduces a method using online SFE-SFC that solves issues 1) to 3). The method increases the purification efficiency in comparison to the conventional method in which the sample solution is injected after pretreatment.

2. Using the Online SFE-SFC System as a Solid Autosampler

In an online SFE-SFC system, the target compounds in the sample are extracted by the SFE unit, and are then introduced directly into the column, with separation performed by the SFC. In other words, the SFE unit could be said to be a solid autosampler. The analyst simply places the solid in the instrument, and the target compounds are automatically introduced into the SFC.

As noted above, if extracts that are extracted or dissolved with supercritical fluid CO₂ which is a weak solvent for SFC, are introduced into SFC, the peak shapes should be retained, even with large volume injections. Also, since the injected solvent and the mobile phase are the same, there is less risk of deposition within the flow lines.

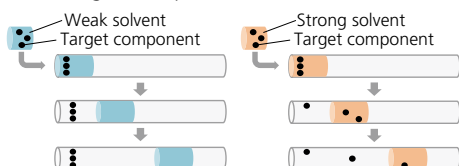

Fig. 1 Mechanism Behind the Occurrence of Peak Leading

The operation of the online SFE-SFC (solid autosampler) is as follows (Fig. 2).

1. Static extraction

Supercritical CO₂ is introduced into the extraction vessel. After the vessel is filled, extraction is performed under static conditions in the vessel without liquid passing through.

2. Dynamic extraction

After static extraction, extraction continues while supercritical CO₂ is passed through the extraction vessel. The extract is introduced into the column from the extraction vessel.

3. Separation and fractionation

The extraction vessel is separated from the flow line. The mobile phase containing a modifier begins to be delivered to the column. The target compounds are enriched and separated within the column. Then, the target compounds with the modifier and makeup solution are fractionated by the fraction collector. (For information on the Nexera™ UC Prep gas liquid separation mechanism, see "Evaluating the Performance of the LotusStream™ Gas-Liquid Separator for Preparative Supercritical Fluid Chromatography")

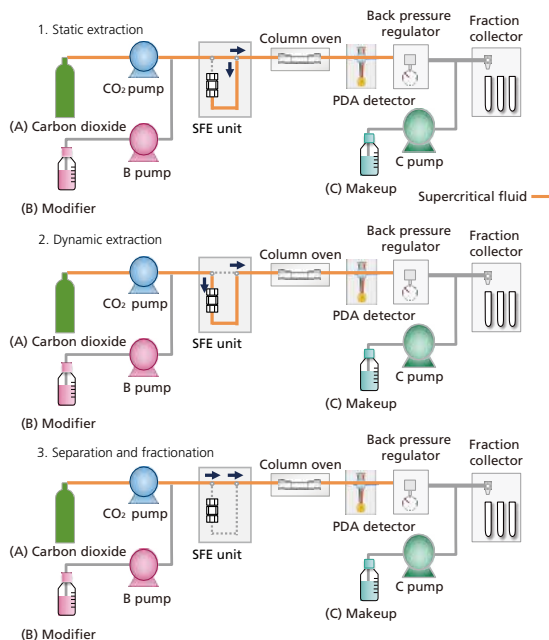

Fig. 2 Operation of Online SFE-SFC

In order to evaluate potential improvements in peak shape from online SFE-SFC, ketoprofen was analyzed with the conditions in Table 1. Also, it was analyzed with a liquid (methanol) injection (2 mL) and both peak shapes were compared. It is evident that sharper peaks were obtained with online SFE-SFC, in which the ketoprofen powder was placed in the extraction vessel (Fig. 3). In the case of purification, using online SFE-SFC enabled the fractionation of the target components while suppressing contamination of the adjacent peaks.

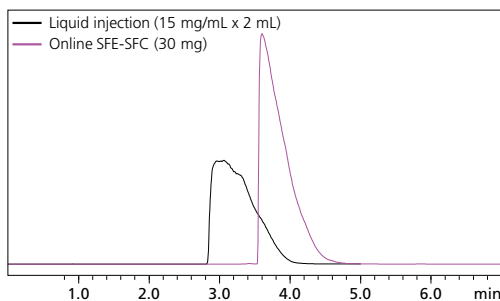

Fig. 3 Comparison of Liquid Injection and Online SFE-SFC

Table 1 Analytical Conditions

<SFE Conditions>	
Extraction vessel	: 5 mL
Mobile phase	: CO ₂ / Methanol = 95:5
Flow rate	: 60 mL/min
Extraction time	: 2 min (Static 1 min, dynamic 1 min)
BPR pressure	: 15 MPa
Extraction temp.	: Ambient
<SFC Conditions>	
Column	: Shim-pack™ UC-Py (250 mm x 20 mm I.D., 5 μm)
Mobile phase	: CO ₂ / Methanol = 80:20
Flow rate	: 60 mL/min
Column temp.	: 40 °C
Heat exchanger	: 40 °C
BPR pressure	: 15 MPa
Detection	: PDA (227 nm)
Flow cell	: High pressure preparative flow cell

3. Adjusting the Sample Load Via the Extraction Time

The column loading capacity is adjusted in sample solutions by controlling the sample concentration and injection volume, whereas in the case of extraction and injection of solid samples, it is adjusted by the dynamic extraction time. Fig. 4 shows the relationship between the dynamic extraction time and the peak area for 500 mg of ibuprofen. The longer the dynamic extraction, the larger the load quantity. The maximum quantity is reached at about 1.5 minutes, at which time it is evident that the area value reaches a peak. Extending the dynamic extraction time enables large quantity sample loading. Note that the analytical conditions are as shown in Table 2.

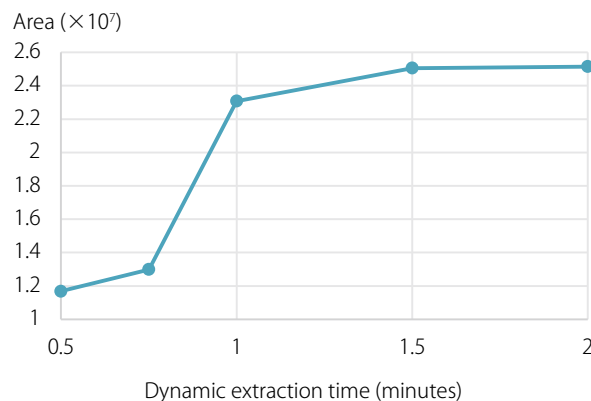

Fig. 4 Changes in Peak Area due to the Dynamic Extraction Time

Table 2 Analytical Conditions

<SFE Conditions>	
Extraction vessel	: 5 mL
Mobile phase	: CO ₂ / Methanol = 95:5
Flow rate	: 60 mL/min
Extraction time	: Static 1 min, dynamic 0.5, 0.75, 1, and 1.5 min
BPR pressure	: 15 MPa
Extraction temp.	: Ambient
<SFC Conditions>	
Column	: Shim-pack UC-Py (250 mm x 20 mm I.D., 5 μm)
Mobile phase	: CO ₂ / Methanol = 80:20
Flow rate	: 60 mL/min
Column temp.	: 40 °C
Heat exchanger	: 40 °C
BPR pressure	: 15 MPa
Detection	: PDA (227 nm)
Flow cell	: High pressure preparative flow cell

4. Improving the Throughput

Improvements in purification throughput can also be expected from online SFE-SFC.

1) Reducing the number of cycles of column injection

With preparative SFC by fluid injection, the sample injection volume is limited because of its solubility, injection volume, and peak broadening. In the case of compounds that are highly soluble in supercritical CO₂, efficient preparative purification can be performed by reducing the number of cycles of injection and recovery by increasing the column load via online SFE-SFC.

2) Shortening the pretreatment time

Preparing the sample solutions is laborious and time-consuming because the appropriate solvent must be selected and the solubility must be evaluated. With online SFE-SFC, pretreatment is not required. Analytical preparation can be started simply by positioning the solid sample, reducing the pretreatment time.

In order to evaluate the efficiency of the purification scheme using online SFE-SFC, a 500 mg mixture of ibuprofen and ketoprofen was used as a model sample. Under the conditions in Table 2, each component was isolated, and the times required with liquid injection and online SFE-SFC were compared. In the case of liquid injection, it took 10 minutes to create a sample solution (methanol solution) approaching the saturation concentration of 5 % (w/v), and for a 2 mL injection, and the 5-minute purification process was repeated 5 times (Fig. 6), so a total of 35 minutes was required. In contrast, with online SFE-SFC, since the interior of the column must be pre-filled with the solvent at the time of extraction, column equilibration took some time. However, almost all of the sample was processed in 3 cycles of analysis (Figs. 5 and 6), so a total of 21 minutes was required. Using online SFE-SFC, the sample volume injected into the column could be increased, and in this example, the time required was reduced 40 % in comparison to liquid injection (Fig. 7).

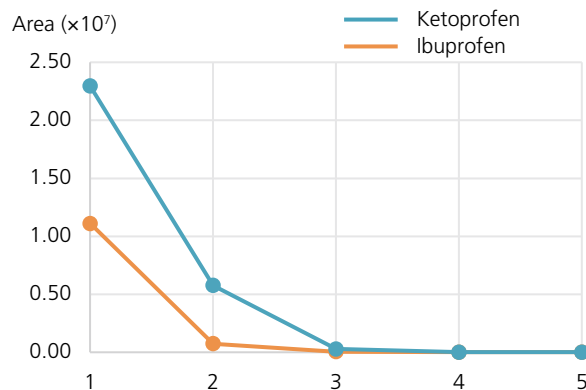

Fig. 5 Plot of Peak Area over Time

Table 3 Analytical Conditions

<SFE Conditions>	
Extraction vessel	: 5 mL
Mobile phase	: CO ₂ / Methanol = 95:5
Flow rate	: 60 mL/min
Extraction time	: 2 min (Static 1 min, dynamic 1 min)
BPR pressure	: 15 MPa
Extraction temp.	: Ambient
<SFC Conditions>	
Column	: Shim-pack UC-Py (250 mm x 20 mm I.D., 5 μm)
Mobile phase	: CO ₂ / Methanol = 80:20
Flow rate	: 60 mL/min
Column temp.	: 40 °C
Heat exchanger	: 40 °C
BPR pressure	: 15 MPa
Detection	: PDA (227 nm)
Flow cell	: High pressure preparative flow cell

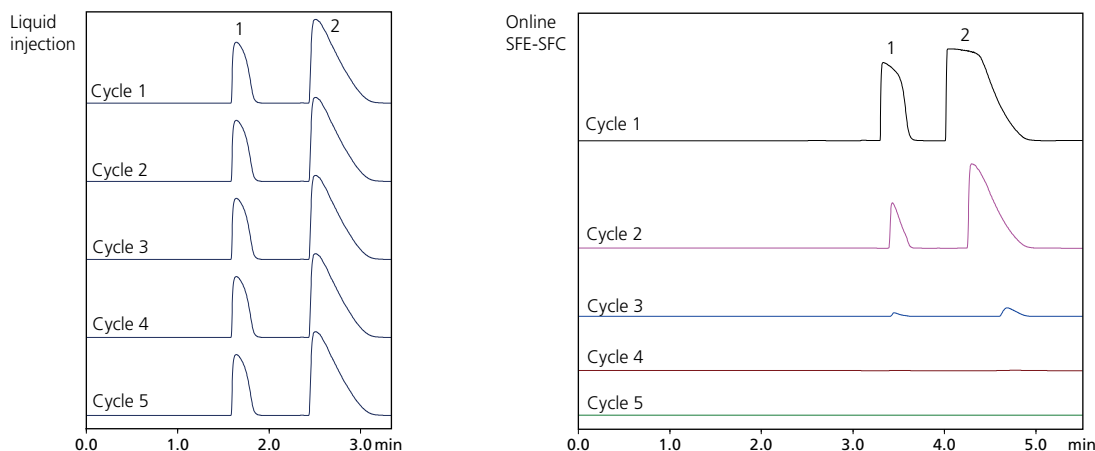

Fig. 6 Chromatograms for Liquid Injection (Left) and Online SFE-SFC (Right) (1: Ibuprofen; 2: Ketoprofen)

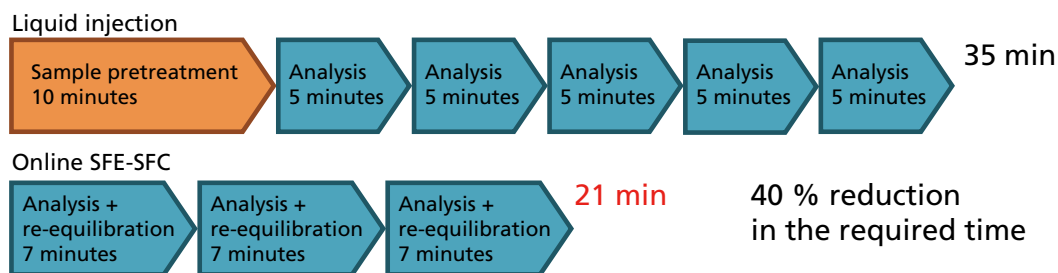

Fig. 7 Comparison of the Time Required for Sample Pretreatment and Fractionation

5. Cautions When Using Online SFE-SFC

In order to maintain good peak shapes with online SFE-SFC, the optimal extraction conditions must be selected, with reference to the recommended conditions raised in Table 4.

(1) Use a Vessel with as Small a Capacity as Possible

When a small extraction vessel is used, the dynamic extraction time is shortened, which should reduce peak broadening. In order to evaluate the impact of the extraction vessel capacity on peak shape, 30 mg of ketoprofen was analyzed in extraction vessels differing in capacity. The results showed that good peak shapes were obtained with a small 0.2 mL extraction vessel (Fig. 8). 30 mg of sample are loaded into a 0.2 mL vessel, so with this amount of sample of less, a 0.2 mL vessel is recommended. For more than this, a 5 mL vessel is used, but by inserting spacers, it can also be used as a 1 mL vessel (Fig. 9).

(2) Cautions Regarding Peak Broadening During Dynamic Extraction

During dynamic extraction, the mobile phase and the extracted target components flow into the column, so there is a risk that peak broadening will occur if the modifier ratio in particular increases, the dynamic extraction time lengthens, and the column inner diameter is narrow. Accordingly, the appropriate combination of modifier ratio, dynamic extraction time, and column inner diameter must be selected.

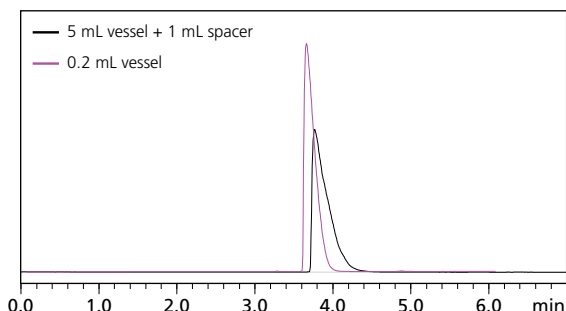

Fig. 8 Comparison of Extraction Vessels



Fig. 9 How to Use a 1 mL Spacer

6. Conclusion

This article has introduced an example of the improvements to the purification scheme using online SFE-SFC (solid autosampler). Using online SFE-SFC offers a variety of advantages: (1) Improved peak shape allows for enhanced separation and enables fractionation in a more concentrated state. (2) A large quantity of sample can be provided to the SFC, which should reduce the number of analysis cycles; (3) Consideration of sample solvents and the process of dissolving the sample in solvents are not required; (4) The risk of deposits due to a solubility difference between the sample solvent and the mobile phase can be reduced.

Additionally, with this method, not only is the time taken by the preparative scheme reduced, but solvent consumption should be reduced due to the reduction in the number of analysis cycles. In particular, a very large amount of solvent is required for one analysis cycle at the preparative scale, so this effect will be striking. Online SFE-SFC is a highly advantageous method from the standpoint of efficiency and the environment, so it should have applications in a variety of fields involving the search for useful compounds, the analysis of impurities in pharmaceuticals, and chemical synthesis.

Table 4 Recommended conditions

System	Column Inner Diameter	Flowrate	Modifier Concentration	Extraction Time (Static Extraction/Dynamic Extraction)	Vessel	Sample
SFE-30A (Analysis Scale)	4.6 mm	3 mL/min	5 %	0.5 min/0.2 min	0.2 mL	< 30 mg
	10 mm	5 mL/min		0.5 min/0.2 min	0.2 mL	< 30 mg
		5 mL/min		2 min/2 min	5 mL*	> 30 mg
SFE-40P (Preparative Scale)	20 mm	15 mL/min		2 min/2 min	5 mL*	> 30 mg
		60 mL/min		1 min/1 min	5 mL*	> 30 mg

*Note: If there is any extra space, inserting 1 mL spacers (228-69904-41) is recommended.

Nexera, LotusStream and Shim-pack are trademarks of Shimadzu Corporation or its affiliated companies in Japan and/or other countries.



Shimadzu Corporation

www.shimadzu.com/an/

For Research Use Only. Not for use in diagnostic procedures.

This publication may contain references to products that are not available in your country. Please contact us to check the availability of these products in your country.

The content of this publication shall not be reproduced, altered or sold for any commercial purpose without the written approval of Shimadzu. Company names, products/service names and logos used in this publication are trademarks and trade names of Shimadzu Corporation, its subsidiaries or its affiliates, whether or not they are used with trademark symbol "TM" or "®".

Third-party trademarks and trade names may be used in this publication to refer to either the entities or their products/services, whether or not they are used with trademark symbol "TM" or "®".

Shimadzu disclaims any proprietary interest in trademarks and trade names other than its own.

The information contained herein is provided to you "as is" without warranty of any kind including without limitation warranties as to its accuracy or completeness. Shimadzu does not assume any responsibility or liability for any damage, whether direct or indirect, relating to the use of this publication. This publication is based upon the information available to Shimadzu on or before the date of publication, and subject to change without notice.