

Applying Japanese
pharmacopeia draft purity test
methods to atrovastatin calcium
hydrate impurity profiling
using 2D-LCMS-IT-TOF system

ASMS 2011 MP08

Tairo Ogura, Ichiro Hirano, Yusuke Inohana,
Yoshihiro Hayakawa, Tsutomu Nakai
SHIMADZU CORPORATION, 1,
Nishinokyo-kuwabaracho, Nakagyo-ku, Kyoto
604-8511, Japan

Applying Japanese pharmacopeia draft purity test methods to atorvastatin calcium hydrate impurity profiling using 2D-LCMS-IT-TOF system

Introduction

Pharmaceutical companies are facing significant challenges as a result of a period exclusivity losses which has opened up new generic competition. As one example, Pfizer's \$10 billion-a-year drug, the cholesterol fighter Lipitor, will lose patent protection in the U.S. in November 2011 which will release the generic form. However, to gain regulatory approval for generic marketing requires strict adherence to regional regulatory requirements. In this report we describe an automated 2D-LCMS-IT-TOF system (Fig. 1) that can be applied to a standard 16th Japanese Pharmacopeia (JP) purity test in the analysis of atorvastatin calcium hydrate (ATO, brand name Lipitor).

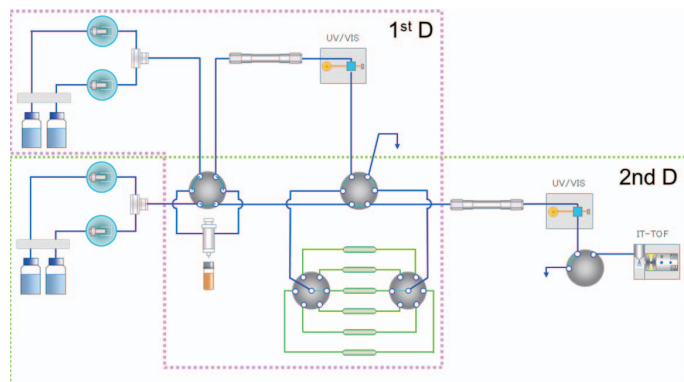

Fig. 1 Flow Diagram of 2D-LCMS-IT-TOF System

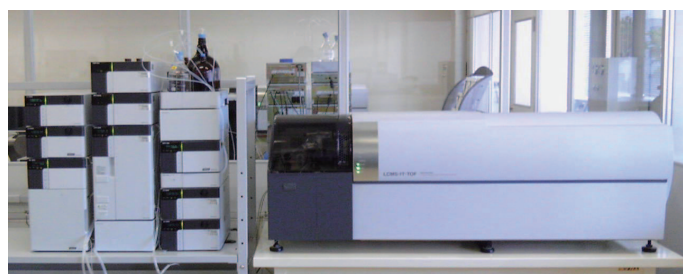

Fig. 2 Photograph of 2D-LCMS-IT-TOF system

Materials and Methods

Sample

1000 µg/mL of Atorvastatin calcium hydrate in water/acetonitrile(1/1)

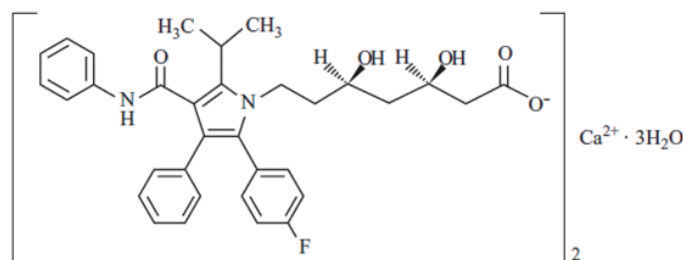

Fig. 3 Structure of atorvastatin calcium hydrate

1stD LC

Column : Shim-pack VP-ODS (4.6 mm I.D. x 250 mmL., 4.6 µm)
 Mobile phase A : Citrate buffer (pH5.0)*/
 Acetonitrile/Tetrahydrofuran (4/1/1)
 Mobile phase B : Acetonitrile/Tetrahydrofuran (1:1)
 Time program : 7%(0-40min) → 40%(80min)
 Flow rate : 1.3 mL/min
 Oven temp. : 40 °C
 Injection vol. : 20 µL
 Wavelength : 254 nm

*Dissolve 10.5g citric acid monohydrate in 900 mL water
 →Adjust pH5.0 by 28% ammonia
 →Add water to make 1L

2ndD LCMS

Column : Shim-pack XR-ODS (2.0 mm I.D. x 50 mmL., 2.2 µm)
 Mobile phase A : 10mM Acetate buffer (pH5.0)**
 Mobile phase B : Acetonitrile
 Time program : 7%(0 min) → 40%(10 min)
 Flow rate : 0.26 mL/min
 Oven temp. : 40 °C
 Injection vol. : 10 µL (Loop volume)
 UV : 254 nm

**Dissolve 572 µL acetic acid in 900 mL water
 →Adjust pH5.0 by 28% ammonia
 →Add water to make 1L

Applying Japanese pharmacopeia draft purity test methods to atorvastatin calcium hydrate impurity profiling using 2D-LCMS-IT-TOF system

Experimental & Results

1stD HPLC analysis based on JP

Analysis of atorvastatin based on JP Impurity test were performed.

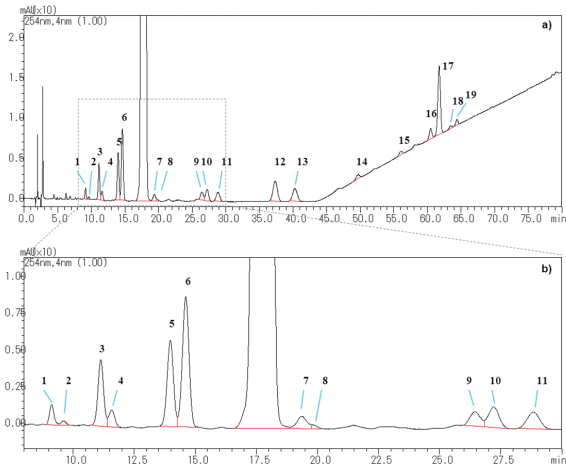

Fig. 4 UV chromatograms of impurity test based on JP

- 19 impurities were detected on UV chromatogram.
- 10 impurities have the area % greater than 0.1 %.

Table 1 Impurities detected on UV chromatogram

ID	R.T.(min)	area(%)	ID	R.T.(min)	area(%)
1	9.12	0.06	11	28.81	0.13
2	9.61	0.01	12	37.34	0.37
3	11.13	0.23	13	40.28	0.24
4	11.58	0.06	14	49.72	0.06
5	13.98	0.34	15	56.05	0.04
6	14.61	0.54	16	60.47	0.11
7	19.35	0.08	17	61.74	0.71
8	19.87	0.01	18	63.44	0.03
9	26.43	0.10	19	64.39	0.05
10	27.21	0.14			

2D LCMS analysis of Impurity 3 based on JP

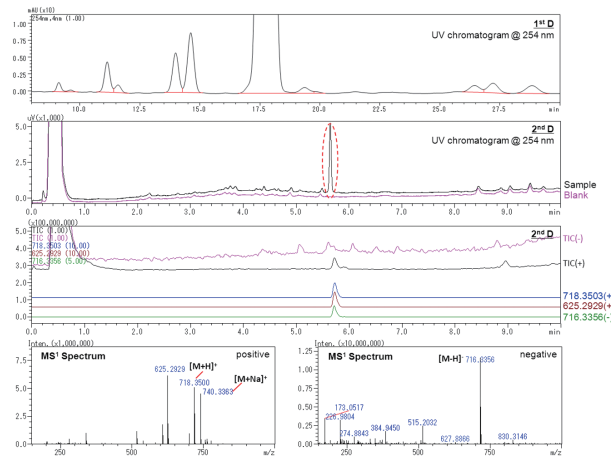

Fig. 5 1st D and 2nd D chromatograms and mass spectra of Impurity 3

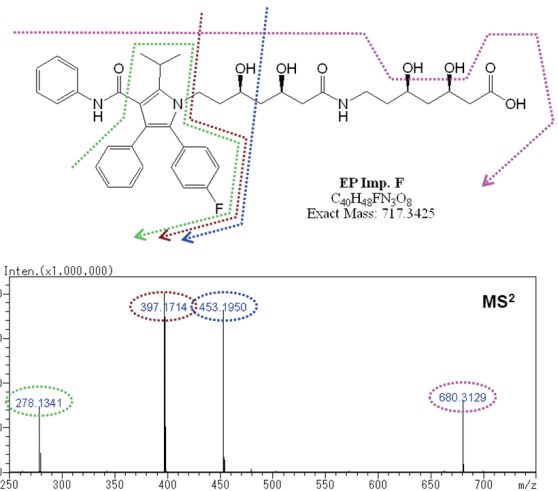
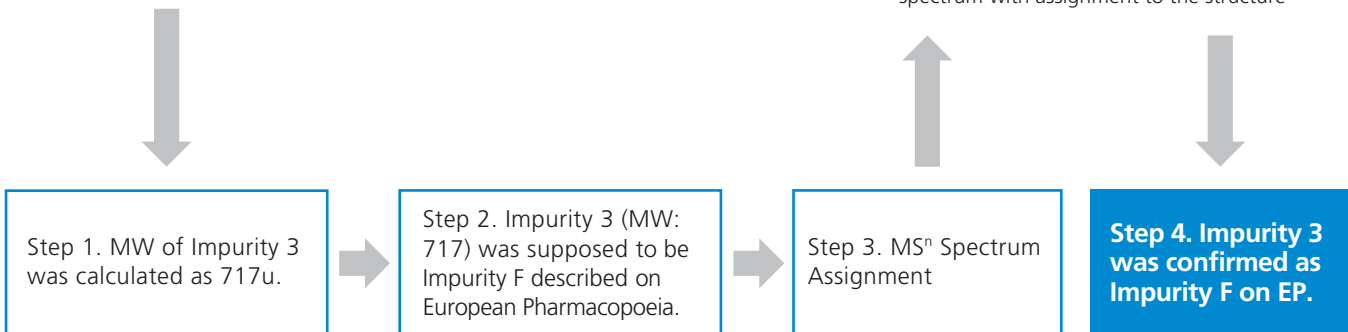

Fig. 6 Structure of EP Impurity F and positive MS² spectrum with assignment to the structure



Applying Japanese pharmacopeia draft purity test methods to atrovastatin calcium hydrate impurity profiling using 2D-LCMS-IT-TOF system

2D LCMS analysis of minor Impurity 2

Area% of Impurity 2 was just 0.013% but beautiful spectrum was obtained.

Only the peak top can be introduced into the LCMS, it is possible to analyze with high sensitivity in the minor peak.

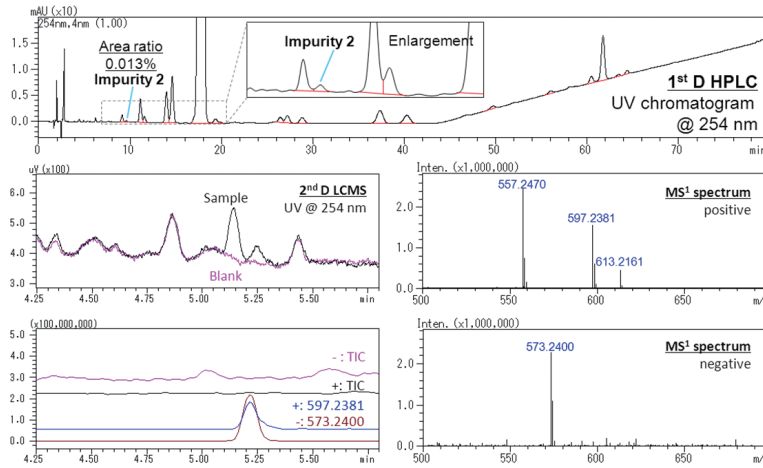

Fig. 7 Result of 2D analysis of Impurity 2

Precise fractionation using 2DLC-IT-TOF

Impurity 6 looks like containing two compounds such as MW 540 and 556.

Peak 6 was fractionated at two positions below.

The presence of two different compounds was clearly confirmed.

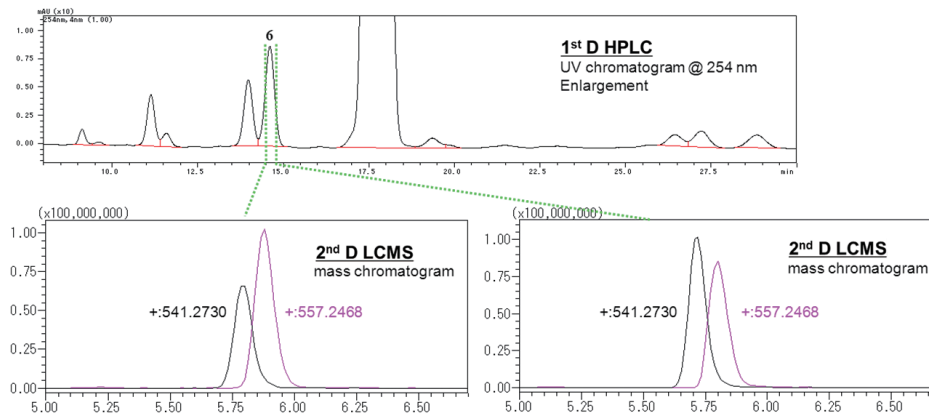

Fig. 8 Precise fractionation of impurity 6 including two component m/z 541 and 557

Applying Japanese pharmacopeia draft purity test methods to atorvastatin calcium hydrate impurity profiling using 2D-LCMS-IT-TOF system

Summary of impurities of atorvastatin

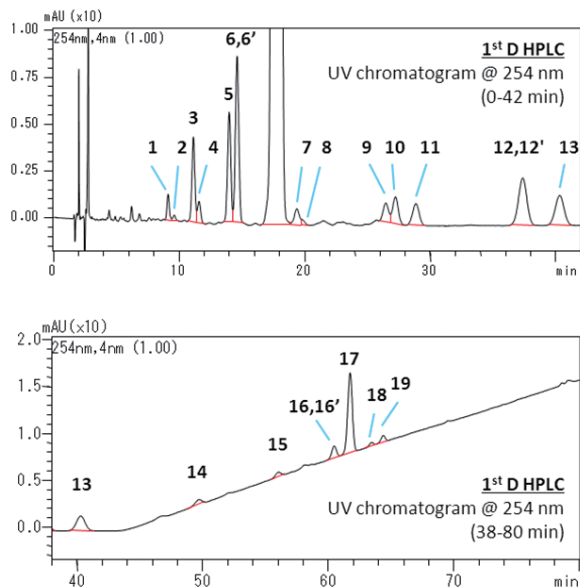

Fig. 9 UV chromatogram of atorvastatin and impurities

Table 2 Result of 2DLC-IT-TOF analysis of atorvastatin

	R.T.(HPLC)	[M+H] ⁺	[M-H] ⁻	Area %	EP Impurity
1	9.12	591.2529	589.2367	0.056	
2	9.606	597.2381	573.2407	0.013	
3	11.133	718.3513	716.335	0.234	F
4	11.582	575.2394	573.2394	0.062	
5	13.979	575.2559	573.2413	0.339	
6	14.608	541.2723	539.2565	0.536	A
6'	14.608	557.2459	555.2305	0.536	
-	17.631	559.2627	557.2479	96.700	(Atorvastatin)
7	19.349	557.2464	555.2325	0.078	
8	19.872	557.247	555.233	0.013	
9	26.429	573.2762	571.2639	0.097	G
10	27.212	629.3046	627.2879	0.137	
11	28.808	591.2536	589.2306	0.128	
12	37.34	573.2413	-	0.368	
12'	37.34	-	589.2357	0.368	
13	40.277	541.2527	539.2353	0.237	H
14	49.723	573.2773	-	0.058	
15	56.052	416.1653	414.1516	0.044	
16	60.472	362.1185	360.1584	0.110	
16'	60.472	432.1607	430.1474	0.110	D
17	61.739	432.1607	430.1468	0.709	D
18	63.442	432.161	430.1447	0.028	D
19	64.387	523.242	523.242	0.053	

Conclusion

- 19 impurity peaks were detected in UV chromatogram and 10 impurities of them have the area % greater than 0.1%. In the result of 2DLC-IT-TOF analysis, 23 components were found in 19 peaks and *m/z* value of each component was confirmed.
- Some of these peaks was found to be corresponding to impurities shown in EP. Especially, Impurity 3 was identified as "EP impurity F" using high mass accuracy MSⁿ data.

Founded in 1875, Shimadzu Corporation, a leader in the development of advanced technologies, has a distinguished history of innovation built on the foundation of contributing to society through science and technology. We maintain a global network of sales, service, technical support and applications centers on six continents, and have established long-term relationships with a host of highly trained distributors located in over 100 countries. For information about Shimadzu, and to contact your local office, please visit our Web site at **www.shimadzu.com**



SHIMADZU CORPORATION. International Marketing Division

3. Kanda-Nishikicho 1-chome, Chiyoda-ku, Tokyo 101-8448, Japan

Phone: 81(3)3219-5641 Fax. 81(3)3219-5710

URL <http://www.shimadzu.com>