

# Development of an ion transmission enhanced tandem ion guide system for triple quadruple mass spectrometer

**ASMS 2012** ThP26-584

Daisuke Okumura; Manabu Ueda; Tomohito Nakano  
Shimadzu Corporation, Nishinokyo-kuwabaracho,  
Nakagyo-ku, Kyoto 604-8511, Japan

# Development of an ion transmission enhanced tandem ion guide system for triple quadrupole mass spectrometer

## Introduction

The application of atmospheric pressure ionization sources in mass spectrometry necessitates the presence of a differential pumping system in order to maintain high vacuum in the analyzer. Commercial triple quadrupole mass spectrometers typically have from 3 to 4 differential pumping stages and an RF ion guide is generally utilized as a ion focusing device in the higher pressure region of the ion path. The ions generated under atmospheric pressure

need to be efficiently focused to minimize the loss of ions prior to introduction into quadrupole analyzer by use of an RF lens system. Using a QqQ with 4 differential pumping stages, we have investigated the application of a fringing field in the RF ion guides installed in the second and third differential pumping stages with a resultant improvement in sensitivity by a factor of five.

## Methods

Three distinct designs of the tandem quadrupole RF ion guide in differential pumping stages have been investigated. In order to examine the characteristics and performance of these configurations, each RF ion guide was installed in a triple quadrupole mass spectrometer (LCMS-8040, Shimadzu Corporation, Kyoto, Japan). Each tandem RF ion guide system had inscribed radii of a) 1.5 mm, b) 2.0 mm and c) 2.8 mm. Each system has one DC lens between RF ion guides, and its diameter was 4 mm.

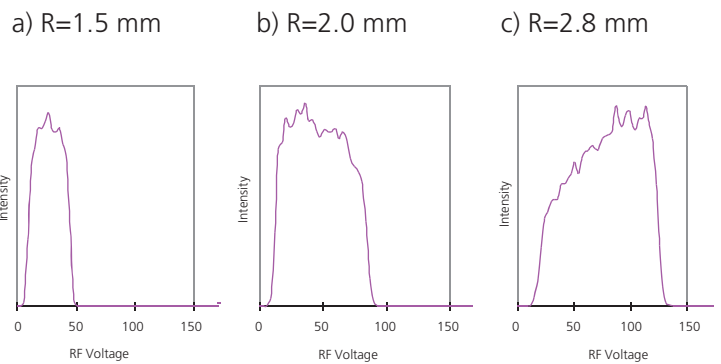

Fig. 2 The optimum operating RF voltage of quadrupole ion guides was acquired experimentally. The voltages were 27 V, 50 V and 100V for R= 1.5, 2.0 and 2.8 respectively.

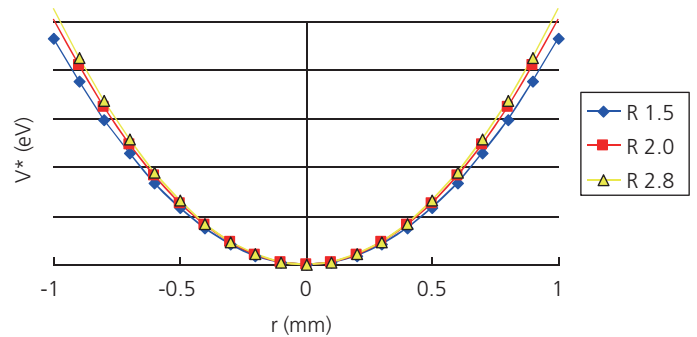

Fig. 3 Pseudo-potential of each tandem RF ion guide systems.

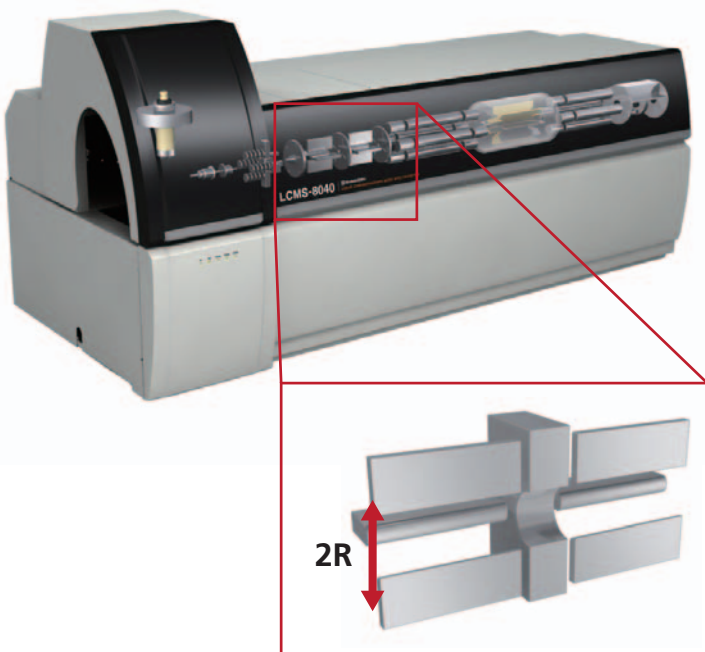

Fig. 1 LCMS-8040 triple quadrupole mass spectrometer.

# Development of an ion transmission enhanced tandem ion guide system for triple quadrupole mass spectrometer

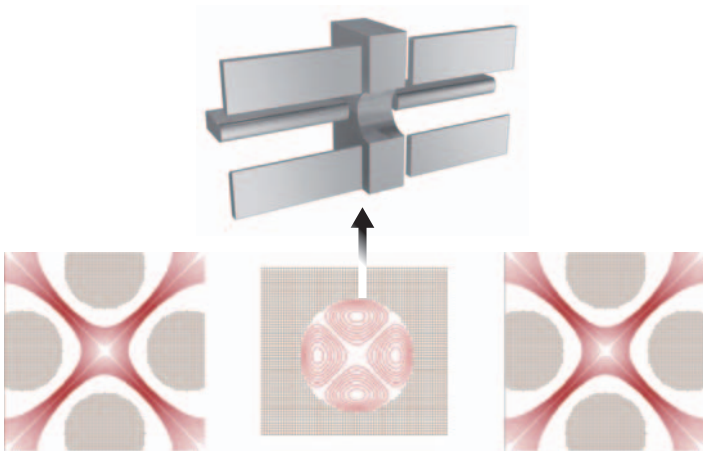

Fig. 4 Simulated fringing focusing field estimates of smaller R ion guides was found to be more effective than those of larger R. Therefore we have achieved higher sensitivity using smaller R ion guides.

## Results

We acquired Q1 scan spectra of pesticides at three different scan speeds with flow injection analysis (5000, 10000 and 15000 u/sec). The benefit of the quadrupole ion guide, with its narrower mass range transmission relative

to hexapole and octopole ion guides, was an increase in the absolute intensity of ion species in the Q1 scan at all three scan speeds by a factor of 2-5 times.

### LCMS-8040

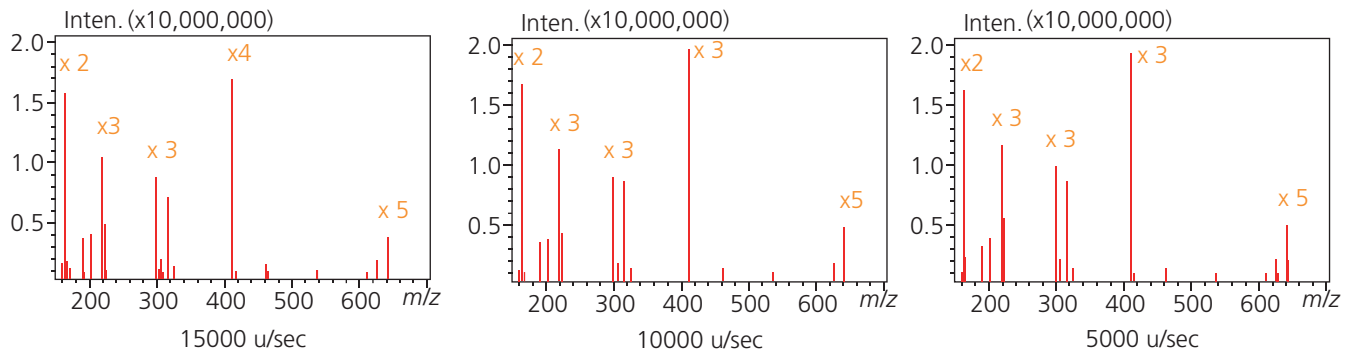

### LCMS-8030

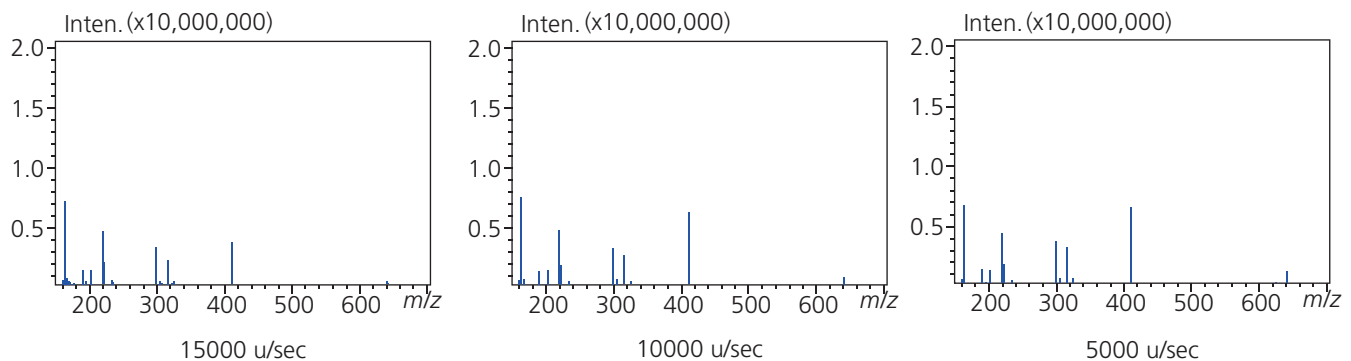
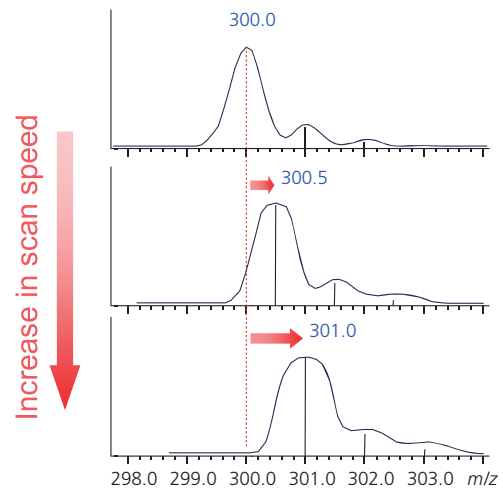

Fig. 5 Q1 scan spectra of pesticides at three different scan speed.

## Development of an ion transmission enhanced tandem ion guide system for triple quadrupole mass spectrometer

In some instruments a mass displacement effect can occur with linked scans, such as precursor or neutral loss scans, when performed at higher scan speeds.

Precursor ion scans were performed at two scan speeds, 2727 u/sec and 6000 u/sec. These scans showed no mass displacement at either speed for either the LCMS-8030 or LCMS-8040. LCMS-8040 sensitivity was about two times higher than for the LCMS-8030.



In case of typical triple quadrupole mass spectrometer

Precursor: ion of  $m/z$  149

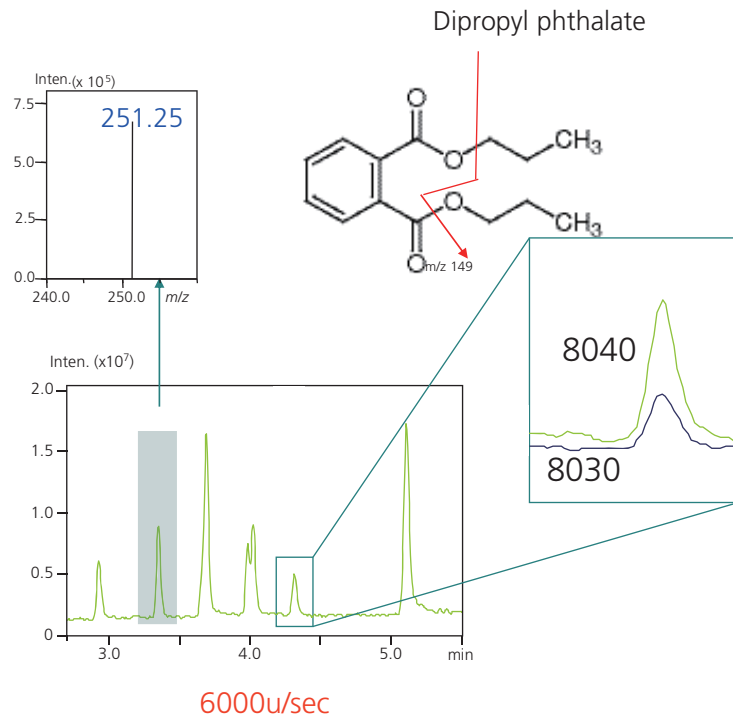
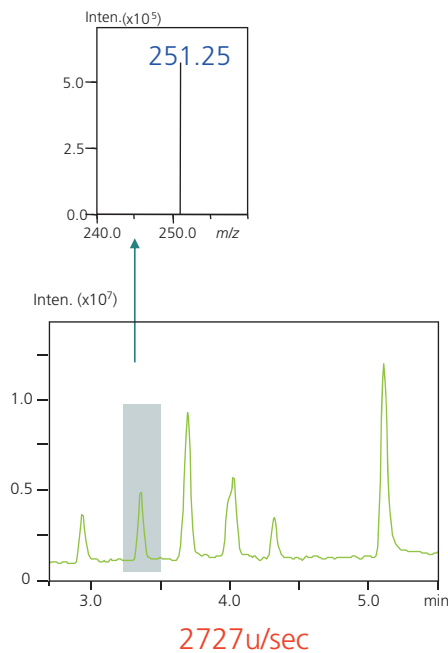

Dipropyl phthalate

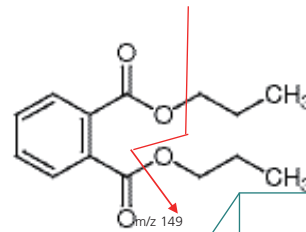

Fig. 6 Precursor ion scan of standard mixture sample of 8 phthalate esters.

## Conclusion

The development of a tandem ion guide system with an enhanced fringing field between two ion guides has

enabled increases in sensitivity for the LCMS-8040 up to a maximum of 5-fold.



Shimadzu Corporation  
[www.shimadzu.com/an/](http://www.shimadzu.com/an/)

For Research Use Only. Not for use in diagnostic procedures.  
The content of this publication shall not be reproduced, altered or sold for any commercial purpose without the written approval of Shimadzu. The information contained herein is provided to you "as is" without warranty of any kind including without limitation warranties as to its accuracy or completeness. Shimadzu does not assume any responsibility or liability for any damage, whether direct or indirect, relating to the use of this publication. This publication is based upon the information available to Shimadzu on or before the date of publication, and subject to change without notice.