

Thermo Scientific Dionex UltiMate 3000 Series

SD, RS, BM, and BX Pumps

Operating Instructions
(Original Operating Instructions)



Revision: 1.7

Date: September 2013



Declaration of Conformity

(Original Declaration of Conformity)

Product: Thermo Scientific Dionex UltiMate 3000 - Pump

Types: **ISO-3100SD, ISO-3100BM**
HPG-3200SD, HPG-3200RS, HPG-3200BX
HPG-3400SD, HPG-3400RS
LPG-3400SD(N), LPG-3400RS, LPG-3400XRS
DGP-3600SD(N), DGP-3600RS

Dionex Softron GmbH herewith declares conformity of the above products with the respective requirements of the following regulations:

- Low-Voltage Directive 2006/95/EC
- EMC Directive 2004/108/EC

The electrical safety of the products was evaluated based on the following standard:

- DIN EN 61010-1:2010
Safety requirements for electrical equipment for measurement, control and laboratory use, Part 1: General Requirements

The Electromagnetic Compatibility (EMC) of the products was evaluated based on the following standard:

- DIN EN 61326:2006
Electrical equipment for measurement, control and laboratory use
EMC Requirements

This declaration is issued for the manufacturer

Dionex Softron GmbH
Part of Thermo Fisher Scientific Inc.
Dornierstraße 4
D-82110 Germering

by the Managing Director, Rüdiger Obst and
the Vice President HPLC, Fraser McLeod.

September 2, 2013

Table of Content

1	Introduction.....	1
1.1	How to Use this Manual	1
1.2	Safety Information	3
1.2.1	Symbols on the Pump and in the Manual	3
1.2.2	Safety Precautions	4
1.2.3	Consignes de Sécurité.....	8
1.3	Intended Use	12
1.4	Federal Communications Commission (FCC) Note.....	13
2	Overview.....	15
2.1	Unit Description.....	15
2.2	Pump Configurations	16
2.2.1	Overview	16
2.2.2	Combinations of UltiMate 3000 Pumps and Solvent Racks	18
2.2.3	Special Information for Biocompatible Pumps	19
2.3	Operating Principle	20
2.4	Front Panel Elements	21
2.5	Rear Panel.....	22
2.5.1	Power Switch.....	23
2.5.2	Fuse Cartridge	23
2.5.3	USB Port.....	23
2.5.4	Digital I/O.....	23
2.5.5	Solvent Rack.....	24
2.6	Fluid Connections	25
2.7	Rear Seal Wash System	26
2.8	Mixing System and Inline-Filter	27
2.9	Purge Unit.....	28
2.10	Leak Sensor.....	28
2.11	Vacuum Degasser	29
2.12	Pulse Damper.....	29
2.13	Operation from Chromeleon.....	30
2.14	Wellness, Predictive Performance, and Diagnostics	31
3	Installation.....	33
3.1	Facility Requirements	33
3.2	Unpacking.....	33
3.3	Positioning the Pump in the UltiMate 3000 System.....	35
3.4	Connecting the Pump.....	37
3.4.1	General Information	37
3.4.2	Connecting the USB Cable.....	37
3.4.3	Connecting the Power Cord.....	38
3.4.4	Connecting the Solvent Rack and Digital I/O	38

3.5	Setting Up the Pump in Chromeleon	40
3.5.1	Loading the USB Driver for the Pump	40
3.5.2	Installing the Pump	42
3.5.3	Configuring the Pump	43
3.5.3.1	Initial Installation	43
3.5.3.2	Changing the Configuration Properties	51
3.6	Setting Up the Pump in DCMSLink	51
3.7	Connecting a Corona or Coulochem III Detector	52
4	Preparation for Operation (Startup)	53
4.1	Overview of Actions	53
4.2	Connecting and Handling Capillaries	55
4.3	Solvent Reservoirs	58
4.3.1	General Notes	58
4.3.2	Connecting the Solvent Reservoirs	60
4.3.2.1	All Pumps Except ISO-3100BM and HPG-3200BX	60
4.3.2.2	ISO-3100BM and HPG-3200BX	61
4.4	Connecting Drain Tubing	62
4.5	Setting Up the Rear Seal Wash System	63
4.6	Purging the Pump	65
4.6.1	Purging the Pump Manually	66
4.6.2	Purging the Pump by Using the Autosampler	68
4.7	Equilibrating the System	69
5	Operation and Maintenance	71
5.1	Power-Up	71
5.2	Status Screen	72
5.3	Operation from Chromeleon	74
5.3.1	Connecting to Chromeleon	74
5.3.2	Direct Control	75
5.3.3	Automated Control	78
5.4	Function Keys and Menus on the Pump Display	80
5.4.1	Showing the Function Keys	80
5.4.2	Pump Menus	82
5.4.2.1	General Menu Layout and Structure	83
5.4.2.2	Main Menu	84
5.4.2.3	Control Menu	85
5.4.2.4	Preferences Menu	86
5.4.2.5	Diagnostics Menu	86
5.4.2.6	Configuration Menu	87
5.5	Information for Operating the Pump	88
5.5.1	Choosing the Solvents	88
5.5.2	Linking the Pump to the Autosampler	91
5.5.3	Setting the Flow Rate, Flow Acceleration, and Flow Deceleration	92
5.5.4	Setting the Pressure Limits	93
5.5.5	Recording the Pump Pressure	94

5.5.6	Rear Seal Wash System.....	94
5.5.6.1	Working with Rear Seal Washing.....	94
5.5.6.2	Choosing the Seal Wash Solution.....	95
5.5.6.3	What happens.....	95
5.5.7	Purging the Pump.....	96
5.5.8	Detecting Liquid Leaks in the Pump.....	97
5.5.9	Adjusting the Screen Brightness or Contrast.....	97
5.5.10	SmartStartup and SmartShutdown.....	98
5.5.11	Vacuum Degasser (LPG-3400 and SRD-3x00).....	99
5.5.11.1	General Notes for Degasser Operation.....	99
5.5.11.2	Turning the Degasser On and Off.....	100
5.5.12	General Precautions for Operating an ISO-3100BM.....	101
5.5.13	General Precautions for Operating an HPG-3200BX.....	102
5.6	Special Chromeleon Functions.....	103
5.6.1	Predictive Performance.....	103
5.6.2	Pump Diagnostics.....	105
5.6.3	Setting a Gradient Curve.....	106
5.6.4	Liquid Level Monitoring for Solvent Reservoirs and Waste Container.....	106
5.6.5	Using the Digital Inputs and Outputs (Digital I/O).....	108
5.6.6	Operational Qualification and Performance Qualification.....	108
5.7	Shutting Down the Pump.....	109
5.8	Routine and Preventive Maintenance.....	111
6	Troubleshooting.....	115
6.1	Overview.....	115
6.2	Pump Block Status Indicator.....	116
6.3	Messages on the Pump Display.....	117
6.4	Chromeleon Diagnostics Messages.....	124
6.5	Operating Problems.....	126
6.6	Checking the Compression Values.....	134
7	Service.....	135
7.1	General Notes and Safety Precautions.....	135
7.2	Eliminating Leakage.....	137
7.3	Rear Seal Wash System.....	138
7.3.1	Inspecting the Rear Seal Wash System for Leakage.....	138
7.3.2	Replacing the Peristaltic Tubing.....	139
7.3.3	Replacing the Detector.....	140
7.3.4	Cleaning the Detector Electrodes.....	140
7.4	Replacing the Check Valve Cartridges.....	141
7.5	Pistons and Piston Seals.....	143
7.5.1	Visually Inspecting the Pump for Piston Seal Leakage.....	149
7.5.2	Pump Head and Pistons.....	150
7.5.2.1	Removing the Pump Head and Pistons.....	150
7.5.2.2	Installing the Pistons and Pump Head.....	152

7.5.3	Replacing the Piston Seals	155
7.5.3.1	Disassembling the Pump Head and Removing the Piston Seals	156
7.5.3.2	Cleaning the Pistons	157
7.5.3.3	Installing the Piston Seals and Reassembling the Pump Head	158
7.5.3.4	Recommended Actions after Main Piston Seal Replacement	161
7.5.3.5	Replacing the Piston Seals in the Plate of the Seal Wash System	162
7.6	Mixing System	165
7.6.1	Replacing the Capillary Mixer and/or Static Mixer	165
7.6.2	Checking the Static Mixer for Permeability	166
7.7	Inline Filter	167
7.7.1	Replacing the Inline Filter (ISO-3100)	167
7.7.2	Inline Filter (LPG-3400BM, DGP-3600BM)	168
7.7.2.1	Replacing the Inline Filter	168
7.7.2.2	Replacing the Filter Frit in the Inline Filter	169
7.7.3	Checking the Inline Filter for Permeability	170
7.8	Replacing the Purge Valve Knob	171
7.9	Testing the Pump for Leakage	172
7.10	Vacuum Degasser (Rinsing the Degassing Channels)	175
7.11	Replacing the Main Power Fuses	176
7.12	Updating the Pump Firmware	177
8	Pump-Specific Information	179
8.1	ISO-3100	180
8.1.1	ISO-3100SD	180
8.1.1.1	Interior Components	180
8.1.1.2	Flow Path	181
8.1.1.3	Operating Principle (Schematics)	182
8.1.2	ISO-3100BM	183
8.1.2.1	Interior Components	183
8.1.2.2	Flow Path	184
8.1.3	Operating Principle (Schematics)	185
8.2	LPG-3400	186
8.2.1	Interior Components	186
8.2.2	Flow Path	187
8.2.3	Operating Principle (Schematics)	189
8.3	DGP-3600	190
8.3.1	Interior Components	190
8.3.2	Flow Path	191
8.3.3	Operating Principle (Schematics)	193
8.4	HPG-3200	194
8.4.1	Interior Components	194
8.4.2	Flow Path	195
8.4.3	Operating Principle (Schematics)	197

8.5	HPG-3400	198
8.5.1	Interior Components	198
8.5.2	Flow Path	199
8.5.3	Possible Gradient Combinations and Operating Principle (Schematics)	200
9	Optimizing the Pump for Specific Applications	203
10	Technical Information	207
10.1	SD Pumps	207
10.2	RS Pumps	208
10.3	BM Pumps	209
10.4	HPG-3200BX	210
11	Accessories, Consumables, and Spare Parts	211
11.1	Standard Accessories	211
11.1.1	SD Pumps	211
11.1.2	RS Pumps	215
11.1.3	BM Pumps	218
11.1.4	HPG-3200BX	220
11.2	Optional Accessories	221
11.3	Consumables and Spare Parts	224
12	Reference Information	235
12.1	Chemical Resistance of PEEK	235
12.2	Solvent Miscibility	238
12.3	Properties of Common Solvents	239
12.4	Safety Information about Flammable Solvents	240
13	Appendix	243
13.1	Digital I/O (Pin Assignment)	243
13.2	Solvent Rack (Pin Assignment)	244
14	Index	245

1 Introduction

1.1 How to Use this Manual

The layout of this manual is designed to provide quick reference to the sections of interest to the reader when operating the Thermo Scientific™ Dionex™ UltiMate™ 3000 pump. However, in order to obtain a full understanding of the pump, Thermo Fisher Scientific recommends that you review the manual thoroughly before beginning operation.

The descriptions in this manual apply to the following models in the UltiMate™ 3000 pump series:

- SD and SDN pumps
ISO-3100SD, LPG-3400SD(N), DGP-3600SD(N), HPG-3200 SD, HPG-3400SD
- RS pumps
LPG-3400RS, DGP-3600RS, HPG-3200RS, HPG-3400RS
- BM pumps
ISO-3100BM, LPG-3400BM, DGP-3600BM
- BX pump
HPG-3200BX

The following conventions apply to the descriptions throughout this manual:

- The term "the device" or "the pump" is used throughout the manual. If some detail applies to only one model or version, the model (version) is identified by name.
If only the pump name is indicated, for example, HPG-3200, the information applies to all pump versions (that is, for the example, to the HPG-3200SD, HPG-3200RS, and HPG-3200BX).
- If not stated otherwise, the descriptions for
 - ◆ the SD pumps apply also to the SDN pumps.
 - ◆ Viper™ capillary connections apply also to nanoViper™ and possible other Viper capillary connections.
- The device configuration may vary. Therefore, not all descriptions necessarily apply to your particular pump.
- The representation of a component in this manual may be slightly different from the real component. However, this does not influence the descriptions.
- The descriptions in this manual refer to firmware version 3.40 and Chromeleon 6.80 Service Release 13. If you want to operate the pump from Chromeleon 7, note the information on page 30.

This manual is provided "as is". Every effort has been made to supply complete and accurate information and all technical specifications have been developed with the utmost care. The information contained in this manual should not be construed as a commitment by Thermo Fisher Scientific. Thermo Fisher Scientific assumes no responsibility for any errors that may appear in this document that is believed to be complete and accurate at the time of publication and, in no event, shall Thermo Fisher Scientific be liable for incidental or consequential damages in connection with or arising from the use of this document. We appreciate your help in eliminating any errors that may appear in this document.

The information contained in this document is subject to change without notice.

All rights reserved, including those for photomechanical reproduction and storage on electronic media. No part of this publication may be copied or distributed, transmitted, transcribed, stored in a retrieval system, or transmitted into any human or computer language, in any form or by any means, electronic, mechanical, magnetic, manual, or otherwise, or disclosed to third parties without the express written permission of Thermo Fisher Scientific Inc.

Trademarks

Analyst is a registered trademark of AB Sciex.

Compass and Hystar are trademarks of Bruker Daltonics.

Empower is a trademark of Waters Corp.

MP35N is a registered trademark of SPS Technologies.

PEEK is a trademark of Victrex PLC.

PharMed is a registered trademark of Saint -Gobain Performance Plastics.

Microsoft, Windows, and Windows Vista are registered trademarks of Microsoft Corp.





All other trademarks are property of Thermo Fisher Scientific Inc. and its subsidiaries.

1.2 Safety Information



The CE Mark label and cTUVus Mark safety label on the pump indicate that the pump is compliant with the related standards.

1.2.1 Symbols on the Pump and in the Manual

The table shows the symbols used on the pump:

Symbol	Description
	Alternating current—Courant alternatif
	Power supply is on (-)—Le module est mis sous tension (-) and Power supply is off (O)—Le module est mis hors tension (O)
	Refer to the Operating Instructions to prevent risk of harm to the operator and to protect the instrument against damage. Référez-vous à ce manuel pour éviter tout risque de blessure à l'opérateur et/ou protéger l'instrument contre tout dommage.
	Label according to the "Measures for Administration of the Pollution Control of Electronic Information Products" (China RoHS) guideline Étiquette "Measures for Administration of the Pollution Control of Electronic Information Products" (China RoHS)
	WEEE (Waste Electrical and Electronic Equipment) label—For more information, see the WEEE Information section in the "Installation and Qualification Documents for Chromatography Instruments" binder. Étiquette DEEE (Déchets d'Équipements Électriques et Electroniques) — Pour plus d'informations, référez-vous au chapitre WEEE Information dans le classeur "Installation and Qualification Documents for Chromatography Instruments".

At various points throughout the manual, the following symbols indicate messages of particular importance:

-  **Tip:** Indicates general information, as well as information intended to optimize the performance of the instrument.
-  **Important:** Indicates that failure to take note of the accompanying information could cause wrong results or may result in damage to the device.
-  **Important:** Indique que ne pas tenir compte de l'information jointe peut conduire à de faux résultat ou endommager l'instrument.

 **Warning:** Indicates that failure to take note of the accompanying information may result in personal injury.

 **Avertissement:** Indique que ne pas tenir compte de l'information jointe peut entraîner des blessures corporelles.

1.2.2 Safety Precautions

When working with analytical instrumentation, you must know the potential hazards of using chemical solvents.

 **Tip:** Before operating the pump for the first time, read this manual once to make yourself familiar with the contents of this manual.

For the safety precautions in French, see section 1.2.3 (→ page 8).

 **Warning:** All users of the device must observe the following safety precautions and all additional safety precautions in this manual to avoid the possibility of personal injury or damage to the device when operating the device or carrying out any maintenance or service procedures.

Observe any warning labels on the pump and see the related sections in these *Operating Instructions*.

- **Protective equipment**

When performing any work on or near the HPLC system, wear personal protective equipment (protective clothing, safety gloves, safety glasses) as required by the hazard of the mobile phase and sample. For information about the proper handling of a particular substance and for advice on specific hazards, refer to the material safety data sheet for the substance you are using. Observe the guidelines of Good Laboratory Practice (GLP).

An eyewash facility and a sink should be close to the device. If any substance splashes on the eyes or skin, wash the affected area and seek medical attention.

- **Hazardous substances**

Many organic solvents, mobile phases, and samples are harmful to health. Be sure that you know the toxic and infectious properties of all substances that you are using. You may not know the toxic or infectious properties of many substances that you are using. If you have any doubt about a substance, treat it as if it contains a potentially harmful substance. For advice on the proper handling of a particular substance, refer to the Safety Data Sheet (SDS) of the manufacturer. Observe the guidelines of Good Laboratory Practice (GLP).

Dispose of waste substance in an environmentally safe manner that is consistent with all local regulations. Do not allow flammable, toxic, and/or infectious substances to accumulate. Follow a regulated, approved waste disposal program. Never dispose of flammable, toxic, and/or infectious substances through the municipal sewage system.

- **Hazardous gases**

Install the HPLC system in a well-ventilated laboratory. If the mobile phase or sample includes volatile or flammable solvents, do not allow them to enter the workspace. If the mobile phase or sample includes volatile or flammable solvents, avoid open flames and sparks.

- **Electrostatic discharge**

Discharge of electrostatic energy may lead to sparking and can constitute a fire hazard. Keep in mind that liquid flowing through capillaries can generate static electricity. This effect is particularly pronounced in insulating capillaries and with non-conductive solvents (for example, pure acetonitrile).

Take appropriate measures to prevent the generation of static electricity near the HPLC system. For example, make sure that the air humidity level in the laboratory is sufficiently high and provide proper ventilation, wear anti-static clothing or shoes, prevent accumulation of air bubbles in waste lines, and use grounded waste containers. Use only non-conductive capillaries to direct solvents into the waste container. With electrically conductive capillaries, make sure that they are properly grounded.

- **Self-ignition of solvents**

Do not use solvents for which the self-ignition temperature is below 150 °C. In case of leakage, these solvents may self-ignite on a hot surface.

- **Capillaries, capillary connections, open connections**

- ◆ Capillaries, especially non-metallic capillaries may burst, slip out of their fittings or may not be screwed in. This may result in substances spraying out of the open connections.
- ◆ In an UltiMate 3000 system, some components are made of PEEK™. This polymer has superb chemical resistance to most organic solvents. However, it tends to swell when in contact with trichloromethane (CHCl₃), dimethyl sulfoxide (DMSO), or tetrahydrofuran (THF). In addition, it is attacked by concentrated acids, such as, sulfuric acid and nitric acid or a mixture of hexane, ethyl acetate, and methanol. In both cases, capillaries may start leaking or they can burst. Swelling or attack by concentrated acids is not a problem with brief flushing procedures.
- ◆ Do not use tubing that is stressed, bent, kinked, or damaged.
- ◆ Capillary connections can be contaminated by harmful substances or harmful substances can escape from open connections.

- ◆ Some capillaries of the RS pumps and some Viper system capillaries are made of MP35N[®], a nickel-cobalt based alloy. Individuals with sensitivity to nickel/cobalt may show an allergic reaction from skin contact.
- ◆ Always wear safety glasses when handling fused silica tubing, for example, during installation or when cutting capillaries to the length.
- Disconnect the pump from all power sources before removing the panels. When the panels are removed, dangerous electrical connections will be exposed. The enclosure must be opened only by Thermo Fisher Scientific service personnel.
- Replace faulty communication cables.
- Replace faulty power cords. Never use a power cord other than the power cords provided for the device.
- Always replace blown fuses with original spare part fuses authorized by Thermo Fisher Scientific.
- Use only the original spare parts and accessories authorized for the device by Thermo Fisher Scientific.
- Avoid looking directly into the pump light LED. Do not use light focusing instruments for viewing the light beam. The high luminosity of the lamp can be harmful to the eyes.
- The pump is primed with 2-propanol. During initial operation of the device, make sure that the solvents used are miscible with 2-propanol. Otherwise, follow the appropriate intermediate steps.
- After operation, rinse out buffers and solutions that form peroxides.
- Before switching from buffer to organic solution, rinse the pump thoroughly with deionized water.
- When switching to another solvent, ensure that the new solvent is miscible with the one contained in the pump. If the solvents are not miscible, the pump can be damaged, for example, by flocculation.
- When operating the HPLC system, always set a lower pressure limit for the pump. This prevents damage resulting from leakage or from running the pump dry. Activate solvent reservoir level monitoring reservoirs (→ page 106).
- Use only standard solvents (HPLC grade) and buffers that are compatible with all parts that may be exposed to solvents.
- Do *not* use methanol from aluminum reservoirs. This may impair the performance of the seals.
- Do not deliver in circles or recycle the eluent. This may impair the performance of the seals.

- When lifting or moving the pump, always lift by the sides of the instrument. Lifting the pump by the front panel may damage the front panel door.
- The open front panel door is not designed to carry weight. Do not place any heavy objects on the open front panel door; this may damage the door.
- To avoid that pressure calibration of the pump is impaired, turn on the pump only when the pump pressure is down. To ensure that the pressure is down, open the purge valve before turning on the pump. If you are operating an ISO-3100BM, observe the precautions on page 101.
- Never run the pump dry. Damage to the pistons or the piston seals could result.
- Before you start operating the pump, check the seal wash reservoir level and refill as needed. After turning on the pump, wait until the wash solution has passed all pump heads.
- Always use fresh rear seal wash solution.
- If the pump flow is interrupted for longer periods (> 1 hour), you have to turn off the lamps in any UV or RF detector connected to the device to prevent evaporation in the flow cell.
If you want to connect a Corona™ or Coulochem™ III detector to the pump, refer to page 52 for details.
- Always use the frits recommended by Thermo Fisher Scientific. This is to prevent particulate matters from entering the HPLC system. Using other frits may considerably affect the system performance.
- Do not use stainless steel frits with the biocompatible pumps. This renders the biocompatibility void. Frits are used on the drawing side (in the solvent reservoirs) and on the high-pressure side (in the inline filter).
- If a leak occurs, turn off the pump and remedy the situation immediately.
- Before interrupting operation for several days or more or when preparing the pump for transport, observe the precautions for shutting down the pump (→ page 109).
- Do not use the pump in ways other than those described in these *operating instructions*.
- Keep the operating instructions near the device to be available for quick reference.

1.2.3 Consignes de Sécurité

Si vous utilisez d'instrumentation analytique, vous devez connaître les risques d'utilisation de produit chimiques.

 **Veillez noter:** Avant de commencer à utiliser l'instrument, assurez-vous que vous vous êtes familiarisés avec le contenu de ce manuel.

 **Avertissement:** Toutes les personnes utilisant l'instrument doivent observer les consignes de sécurité suivantes et dans les autres chapitres de ce manuel pour éviter une mise en danger de sa personne ou de dommage à l'instrument pendant l'utilisation et des opérations de maintenance ou service de l'instrument.

Observez les étiquettes d'avertissement sur l'instrument et référez-vous aux sections correspondantes dans ce mode d'emploi.

- **Equipment de protection**

Pour tous les travaux sur le système HPLC ou à proximité, portez l'équipement de protection personnel (vêtements de protection, gant de sécurité, lunettes de protection) qui correspond aux risque découlant de la phase mobile et/ou de l'échantillon. Pour les informations sur la manipulation correcte des composés et des recommandations pour les situations de risque spécifiques, veuillez consulter la fiche de données de sécurité des substances que vous utilisez. Veuillez respecter des directives des Bonnes Pratiques de Laboratoire (BPL).

Une installation permettant de se laver les yeux ainsi qu'un lavabo doivent se trouver à proximité du système. Si une substance, quelle qu'elle soit, entre en contact avec vos yeux ou votre peau, rincez abondamment la zone affectée à l'eau, puis.

- **Substances dangereuses**

De nombreux solvants organiques, phases mobiles et échantillons sont nuisibles à la santé. Informez-vous de propriétés toxicologiques et infectieuses de toutes les substances que vous utilisez. Les propriétés toxicologiques et infectieuses de nombreuses substances peuvent être mal connues. Au moindre doute concernant une substance, traitez-la comme s'il contenait une substance potentiellement dangereuse. Pour des instructions comment utiliser correctement des composés particuliers, veuillez consulter à la fiche de données des sécurités du fabricant respectif. Veuillez respecter des directives des Bonnes Pratiques de Laboratoire (BPL).

Débarassez-vous de tous les déchets de substances de manière écologique, conformément à la réglementation en vigueur au niveau local. Empêchez impérativement l'accumulation de solvants inflammables, toxiques et/ou infectieux. Suivez un programme d'élimination des déchets réglementé et approuvé. Ne jetez jamais de solvants inflammables, toxiques et/ou infectieux dans le système municipal d'évacuation des eaux usées.

- **Gaz dangereux**

Installez le système HPLC dans un laboratoire bien ventilé. Si la phase mobile ou l'échantillon contient des solvants volatils ou inflammables, vous devez assurer qu'ils ne pénètrent dans l'espace de travail. Si la phase mobile ou l'échantillon contient des solvants volatils ou inflammables, évitez les flammes nues et les sources d'étincelles à proximité.

- **Décharge électrostatique**

Décharge électrostatique peut provoquer la formation d'étincelles et peut présenter un risque d'incendie. Veuillez noter que des solvants fluides dans les capillaires peuvent se charger automatiquement. Cet effet se peut produire particulièrement forte dans les capillaires isolants et avec des solvants non-conducteurs (par exemple, l'acetonitrile pur).

Prenez des mesures appropriées pour éviter les charges électrostatiques à proximité du système HPLC. Par exemple, s'assurez qu'il y a une humidité de l'air suffisante et une ventilation adéquate dans le laboratoire, portez des vêtements ou équipement de protection antistatique, évitez l'accumulation de bulles d'air dans les lignes de déchets et utilisez des réservoirs à déchets mis à la terre.

Utilisez uniquement des capillaires non-conducteurs pour diriger solvants au réservoir de déchets. Capillaires électriquement conducteur devrait être mis à la terre.

- **Inflammation spontanée des solvants**

N'utilisez aucun solvants avec une température d'auto-inflammabilité inférieure à 150° C. Si une fuite se produit, ces solvants peuvent s'auto-enflammer au contact d'une surface chaude.

- **Capillaires, connecteur capillaires, connexions ouvertes**

- ◆ Des capillaires, en particulier les capillaires non-métalliques, pourraient fendre ou glisser des connecteurs ou ne peuvent pas être vissés. Ceci peut en résulter aussi que des substances pourraient jaillir des connexions ouvertes.
- ◆ Dans un système UltiMate 3000, certaines composantes sont en PEEK. Bien que ce polymère présente une excellente résistance chimique à la plupart des solvants organiques, il a tendance à gonfler lorsqu'il est en contact prolongé avec du chloroforme (CHCl₃), du diméthyle sulfoxyde (DMSO) ou du tétrahydrofurane (THF). De plus, il est attaqué par des acides concentrés tels que l'acide sulfurique et l'acide nitrique ou d'un composé du hexane, éthyle acétate et méthanol. Ceci peut causer des capillaires de fuite ou risquer des capillaires d'éclater. Ces acides peuvent cependant être utilisés dans le cadre de procédures de nettoyage, à condition que l'exposition soit brève.
- ◆ N'utilisez pas de capillaires écrasés, pliés, abimés ou endommagés.
- ◆ Les connecteurs capillaires pour pourrait être contaminé par des substances dangereuses ou des substances dangereuses pourrait sortir des connexions ouvertes.

- ◆ Certains capillaires des pompes RS, ainsi que des capillaires du système Viper, sont faits d'alliage de nickel-cobalt MP35N. Contact avec la peau peut provoquer une réaction chez les personnes qui sont sensibles au nickel/cobalt.
- ◆ Portez des lunettes de protection lorsque vous manipulez des capillaires en silice fondue (pendant l'installation, découpe, etc.).
- Quand les capots de protection de l'appareil sont démontés, vous êtes exposés à des connexions électriques sous haute tension deviennent accessibles. Débranchez l'instrument de toute source d'alimentation électrique avant de retirer les capots. Ne démontez les capots de protection que si cela est explicitement demandé au cours de ces instructions. Les capots de protection devraient être démontés uniquement par le personnel de service de Thermo Fisher Scientific.
- Remplacez les câbles de communication défectueux.
- Remplacez les cordons d'alimentation électrique défectueux. Utilisez uniquement les cordons d'alimentation électrique spécifique à l'instrument.
- Remplacez toujours les fusibles grillés par des fusibles de rechange autorisés par Thermo Fisher Scientific.
- Utilisez seulement des pièces de rechange originales et des accessoires autorisés par Thermo Fisher Scientific.
- Ne regardez jamais directement la DEL pour l'éclairage intérieur dans la pompe et ne regardez pas du faisceau lumineux par des instruments qui focalisent le rayon lumineux. L'intensité lumineuse de la lampe peut être nocive pour les yeux.
- Réglez toujours une limite de pression minimum pour la pompe HPLC. Ceci prévient les dommages résultant de fuites ou de long-terme fonctionnement à sec de la pompe. Activez la surveillance de niveau liquide pour des réservoirs (→ page 106).
- La pompe est stockée sous 2-propanol. Au cours démarrage de la pompe, assurez-vous que les solvants utilisés soient miscibles avec le 2-propanol. Sinon, suivez les étapes intermédiaires appropriées.
- Après utilisation, purgez le système des tampons et des susceptibles de former des peroxydes.
- Lorsque vous passez d'une solution saline à un solvant organique, effectuez un rinçage intermédiaire de la pompe à l'eau dé-ionisée.
- Lorsque vous passez à un autre solvant, assurez-vous que le nouveau solvant soit miscible avec celui qui se trouve dans la pompe. Dans le cas contraire, la pompe peut être endommagée; par exemple, par des floculations!
- Utilisez uniquement des solvants (qualité HPLC) et des solutions salines compatibles avec les matériaux exposés phase mobiles.

- N'employez pas du méthanol stocké dans des réservoirs en aluminium. Ceci peut affecter les performances des joints.
- Thermo Fisher Scientific déconseille de recycler les solvants. Ceci peut nuire aux performances des joints.
- Le panneau avant bascule vers le haut. Afin d'éviter d'endommager la pompe lorsque que vous la soulevez ou la déplacez, saisissez-la toujours par les côtés de l'unité.
- Ne placez aucun objet lourd sur la porte ouverte du panneau avant. Ceci pourrait endommager la porte.
- Afin d'éviter que le calibrage de pression de la pompe ne soit pas entravé, mettez en marche la pompe seulement quand la pompe est sans pression. Toujours ouvrez la vis de purge avant mettre la pompe en marche. Si la pompe est une ISO-3100BM, observez les précautions figurant en page 101.
- Ne faites jamais fonctionner la pompe à sec. Il peut en résulter des dommages aux pistons ou aux joints de piston.
- Avant de mettre en marche la pompe, assurez-vous que le réservoir de rinçage du joint arrière est rempli. Attendez jusqu'à ce que le rinçage du joint arrière ait été pompé par toutes les têtes de pompe.
- Utilisez toujours le liquide frais pour le rinçage du joint arrière.
- Si le débit de la pompe est interrompu pour des périodes prolongées (> 1 heure), éteignez les lampes de tout détecteur UV ou RF raccordé à la pompe. Ceci empêchera l'évaporation dans la cellule.
Si vous utilisez un détecteur Corona ou Coulochem III avec la pompe, observez les remarques figurant en page 52.
- Utilisez toujours les frittés recommandés par Thermo Fisher Scientific afin d'empêcher les particules étrangères d'entrer dans le système HPLC. Utiliser d'autres frittés peut affecter considérablement les performances du système.
- N'employez pas des frites d'acier inoxydable avec des versions biocompatible de la pompe. Ceci rend vide de compatibilité biologique de la pompe.
- Si une fuite survient, arrêtez l'instrument et résolvez le problème immédiatement.
- Avant d'interrompre le fonctionnement pendant plusieurs jours ou plus, observez les précautions figurant en page 109.
- N'utilisez pas la pompe de manière autre que celles décrites dans ce manuel.
- Conservez ce manuel à proximité de l'instrument pour pouvoir le consulter facilement.

1.3 Intended Use

For Research Use Only. Not for use in diagnostic procedures.

The device is designed to be operated only by qualified and authorized personnel. All users must know the hazards presented by the device and the used substances.

The pump is designed for laboratory research use in high-performance liquid chromatography (HPLC) or ultra-high performance liquid chromatography (UHPLC) applications. It is part of the UltiMate 3000 system, but can be used also with other HPLC systems if adequate control inputs and outputs are available. A PC with USB port is required.

The pump is operated with the Chromeleon Chromatography Management System. Being part of the UltiMate 3000 system, the pump can also be operated with other data systems, such as

- Xcalibur™, Compass™/HyStar™, or Analyst®
To do so, installation of the DCMS^{Link} (Dionex Chromatography Mass Spectrometry Link) software is required in addition to the installation of the data system.
- Empower™
Installation of the Dionex Instrument Integration Software is required in addition to the installation of the data system.

For more information, contact the Thermo Fisher Scientific sales organization for Dionex HPLC Products.

Note that the pump may be operated only with accessories and spare parts recommended by Thermo Fisher Scientific (→ page 211) and within its technical specifications (→ page 207). If there is any question regarding appropriate usage, contact Thermo Fisher Scientific before proceeding. Thermo Fisher Scientific cannot be held liable for any damage, material or otherwise, resulting from inappropriate or improper use of the pump.



Warning:

If the device is used in a manner not specified by Thermo Fisher Scientific, the protection provided by the device could be impaired. Thermo Fisher Scientific assumes no responsibility and will not be liable for operator injury and/or instrument damage. Whenever it is likely that the protection is impaired, the instrument must be disconnected from all power sources and be secured against any intended operation.



Avertissement:

Si l'instrument est utilisé de façon non spécifiée par Thermo Fisher Scientific, la protection prévue par l'instrument pourrait être altérée. Thermo Fisher Scientific n'assume aucune responsabilité et ne sera pas responsable des blessures de l'opérateur et/ou des dommages de l'instrument. Si la protection de l'instrument n'est pas garanti à tout moment, débranchez l'instrument de toutes les sources d'alimentation électrique et assurez-vous que l'instrument n'est pas utilisé involontairement.

1.4 Federal Communications Commission (FCC) Note

This equipment has been tested and found to comply with the limits for a Class A digital device, pursuant to part 15 of the U.S. FCC Rules. These limits are designed to provide reasonable protection against harmful interference when the equipment is operated in a commercial environment. This equipment generates, uses, and can radiate radio frequency energy and, if not installed and used in accordance with the instruction manual, may cause harmful interference to radio communications. Operation of this equipment in a residential area is likely to cause harmful interference, in which case the user will be required to correct the interference at his expense.

2 Overview

2.1 Unit Description

The pump is the heart of the UltiMate 3000 system. The pump performs equally well as a flexible and reliable module for routine analysis and sophisticated research tasks in HPLC and UHPLC and can be used in numerous laboratory environments:

- The patented isokinetic pre-compression allows a precise and almost pulse-free flow.
- The technical specification meets the highest requirements for flow rate reproducibility, zero pulsation, and operational reliability (→ page 207).
- All pumps are fitted with floating pistons, allowing compensation for small mechanical tolerances within the specification and thus enhancing the robustness of the pump.
- As a standard, all pumps are equipped with an active rear seal wash system (→ page 26).
- Various monitoring and diagnostic features are provided for optimum system performance and reliability (→ page 31).
- The pump is designed for easy access to the fluid components, allowing fast and reliable maintenance while the instrument remains in the UltiMate 3000 system stack.
- For the secure and functional positioning of the solvent reservoirs on top of the pump, the Solvent Racks of the UltiMate 3000 series are available from Thermo Fisher Scientific (→ page 18). Except for the SR-3000, all Solvent Racks include an integrated vacuum degasser.
- The pump can be fully controlled by the Chromeleon Chromatography Management System, providing a high degree of system integration.
- All parts that may be exposed to solvents are made of materials that provide optimum resistance to the most commonly used solvents and buffer solutions.

2.2 Pump Configurations

2.2.1 Overview

The pump is available in the following configurations:

Pump	Description	Part No.
ISO-3100SD	Isocratic pump (analytical, 1 solvent) working pressure: up to 62 MPa (9000 psi)	5040.0011
ISO-3100BM	Same as ISO-3100SD, however as biocompatible micro pump with pulse damper (→ page 29) working pressure: up to 41 MPa (6000 psi)	5042.0011
LPG-3400SD	Low-pressure gradient pump (analytical, 4 solvents) with integrated vacuum degasser working pressure: up to 62 MPa (9000 psi)	5040.0031
LPG-3400SDN*	Same as LPG-3400SD, however with NP seals preinstalled as main piston seals	5040.0030
LPG-3400RS	Same as LPG-3400SD, however, as biocompatible pump for a working pressure of up to 103 MPa (15000 psi)	5040.0036
LPG-3400BM	Same as LPG-3400SD, however, as biocompatible micro pump working pressure: up to 50 MPa (7250 psi)	
DGP-3600SD	Dual low-pressure gradient pump (analytical) Two separate pumps in one enclosure (2 x 3 solvents), working pressure: up to 62 MPa (9000 psi)	5040.0061
DGP-3600SDN*	Same as DGP-3600SD, however with NP seals preinstalled as main piston seals	5040.0060
DGP-3600RS	Same as DGP-3600SD, however, as biocompatible pump for a working pressure of up to 103 MPa (15000 psi)	5040.0066
DGP-3600BM	Same as DGP-3600SD, however, as biocompatible micro pump working pressure: up to 50 MPa (7250 psi)	
HPG-3200SD	High-pressure gradient pump (analytical; 2 solvents) working pressure: up to 62 MPa (9000 psi)	5040.0021
HPG-3200RS	Same as HPG-3400SD, however, as biocompatible pump for a working pressure of up to 103 MPa (15000 psi)	5040.0026

Pump	Description	Part No.
HPG-3200BX	High-pressure gradient pump (semipreparative, biocompatible, 2 solvents) working pressure: up to 16 MPa (2400 psi)	5042.0025
HPG-3400SD	High-pressure gradient pump (analytical) with solvent selector (2 from 4) working pressure: up to 62 MPa (9000 psi)	5040.0041
HPG-3400RS	Same as HPG-3400SD, however, as biocompatible pump for a working pressure of up to 103 MPa (15000 psi)	5040.0046

* Available for order in January 2013

The isocratic pumps and the micro pumps have an inline filter installed. All other pumps are shipped with a two-step mixing system, including a capillary mixer and a static mixer. For more information, see page 27.

2.2.2 Combinations of UltiMate 3000 Pumps and Solvent Racks

The Solvent Racks of the UltiMate 3000 system series are an ideal complement to the pumps of the UltiMate 3000 pump series, whether you need high efficiency degassing of the solvents or simply want to safely organize your solvent reservoirs.

Solvent Rack	Part No.
SRD-3200 Solvent Rack with <i>analytical</i> 2-channel vacuum degasser typically for use with the following pumps: - one HPG-3200 (SD or RS) - one ISO-3100SD	5035.9250
SRD-3400 Solvent Rack with <i>analytical</i> 4-channel vacuum degasser typically for use with the following pumps: - one HPG-3400 - two HPG-3200 (SD or RS) pumps in a two-stack system - one HPG-3200 (SD or RS) or ISO-3100SD if you want to degas the solvents and the wash solution of an UltiMate 3000 series autosampler	5035.9245
SRD-3600 Solvent Rack with <i>analytical</i> 6-channel vacuum degasser typically for use with the following pumps: - one DGP-3600 - two HPG-3200 (SD or RS) pumps in a two-stack system - one HPG-3200 (SD or RS) and one HPG-3400 in a two-stack system - one HPG-3400 if you want to degas the solvents and the wash solution of an UltiMate 3000 series autosampler	5035.9230
SR-3000 Solvent Rack <i>without</i> vacuum degasser typically for use with a LPG-3400, ISO-3100BM, or HPG-3200BX	5035.9200

 **Tip:** A Solvent Rack with an *analytical* degasser cannot be used with a *semipreparative* HPG-3200BX pump.

For information about online degassing of the wash solution, see the *Autosampler manual*.

2.2.3 Special Information for Biocompatible Pumps

The UltiMate 3000 pump series includes the following biocompatible pump types:

- LPG-3400RS, LPG-3400BM
- DGP-3600RS, DGP-3600BM
- HPG-3200RS, HPG-3400RS, HPG-3200BX
- ISO-3100BM

Except for the fluid components, the biocompatible pumps are identical to the SD pumps. Therefore, almost all descriptions in this manual apply also to the biocompatible pump types. If some detail applies to only one pump type, the type will be identified by name. The differences are as follows:

The fluid components are made of titanium or MP35N (capillaries in the RS pump). Titanium is a base material, similar to aluminum and magnesium. When titanium is processed, a titanium oxide film builds up on the component surface, ensuring excellent corrosion resistance. The color of titanium and stainless steel is slightly different. In addition, titanium parts are lighter than parts made of stainless steel. Nevertheless, you can easily confuse titanium with stainless steel parts.

Observe the following:

- When substituting parts be sure to install the appropriate replacement part for the BM pumps. For information about the part numbers and for installation details, see the service sections (→ page 135 and following pages) and the Consumables and Spare Parts section (→ page 224).
- When connecting the solvent reservoirs, make sure to use appropriate filter frits on the end of the solvent supply lines. As a standard, filter holders with *stainless steel* frits are provided in the accessories kit of the Solvent Rack. Replace these stainless steel frits with the frits from the accessories kit of the pump (→ page 59).
- Ring seals with a titanium spring are installed as main piston seals in the biocompatible pumps, whereas common ring seals with a steel spring are used in the SD pumps. Do not confuse these seals.

2.3 Operating Principle

The pump is a zero-pulsation, serial dual-piston pump with electronic compressibility compensation. The pump head includes two cylinders—working cylinder and equilibration cylinder—that are connected in series. The solvent passes both cylinders successively.

Continuous delivery is achieved as follows: The working cylinder delivers at the appropriate flow rate while simultaneously filling the serially connected equilibration cylinder. The latter serves as a reservoir and delivers while the working cylinder carries out the suction stroke.

The characteristic feature of the patented isokinetic pre-compression is the overlapping phase of the delivery strokes of the working and equilibration cylinders. When delivering compressible liquids without controlled pre-compression, the pulsation increases as the working pressure increases, since part of the delivery stroke is required for compressing the solvent in the working cylinder. Pulsation during the pre-compression phase is reduced to a minimum by velocity modulation of the drive. The highly constant delivery is ensured by a patented secondary control system (automatic compressibility compensation). The flow rate is always kept constant in relation to the atmospheric pressure.

The schematics in section 8 illustrate how the pumps operate (→ page 179).

2.4 Front Panel Elements



Fig. 1: Front panel view

No.	Element	Description
1	Display	Shows information about the pump, for example: <ul style="list-style-type: none"> - General information upon power-up of the pump (→ page 71) - Status screen (→ page 72) - Functions and menus (→ pages 80 and 82) - Messages (→ page 117)
2	Standby button	Switches the pump to Standby mode (the LED is red). To cancel Standby mode and resume operation, press the Standby button again (the LED is not lighted). <i>Notes:</i> To allow the pump to change the mode, press and hold the Standby button for at least one second. If you switch a pump to which a SRD-3x00 Solvent Rack is connected to the Standby mode, the Solvent Rack, too, will be set to Standby mode.
3	Status LEDs	
	Power	The LED is blue when the pump is turned on.
	Connected	The LED is green when the pump is connected in Chromeleon.
	Status	The LED is green when the pump is ready for operation. The LED is red when an error has been detected, for example, a leak.

2.5 Rear Panel

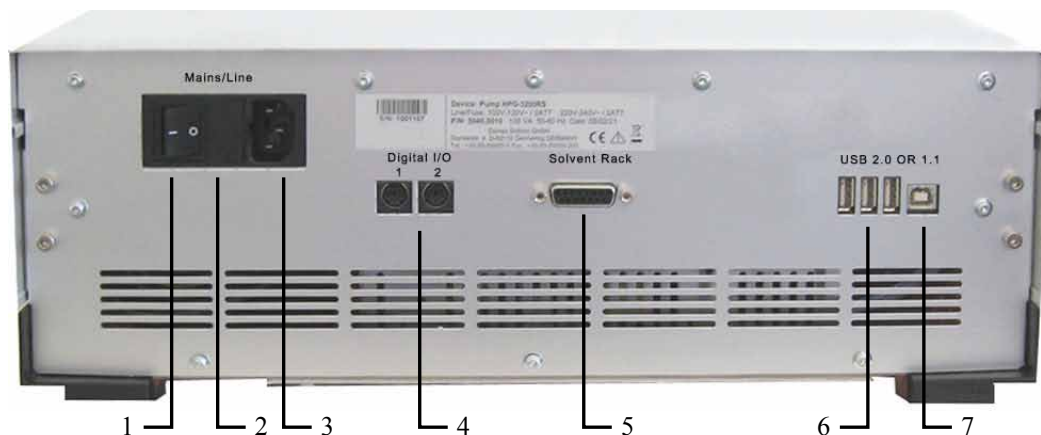

Fig. 2: Rear panel view

No.	Description
1	Power switch (→ page 23)
2	Fuse cartridge (→ page 23)
3	Main power receptacle (→ page 38)
4	Digital I/O ports for communication with external devices (→ page 23)
5	Solvent Rack port for connection of a SRD-3x00 Solvent Rack (→ page 24)
6	USB hub (3 USB ports, USB 2.0 or 1.1) Depending on the UltiMate 3000 system configuration, for connection of one UltiMate 3000 system module each or for connection of one USB hub each (→ page 23).
7	USB port (USB 2.0 or 1.1) for connecting the pump to the Chromeleon computer (→ page 23)

2.5.1 Power Switch

The main power switch is on the rear panel. The main power switch is used to turn the pump on or off.

2.5.2 Fuse Cartridge

The fuse cartridge contains two slow-blow fuses rated at 2 A, 250 V. For information about how to change the fuses, see page 176.

2.5.3 USB Port

The Chromeleon Chromatography Management System can use a USB connection to control the pump. Data is transferred digitally by means of the appropriate USB cable (→ page 37).

You can use the internal USB hub (→ Fig. 2, no. 10) to connect three other instruments in the UltiMate 3000 product line, depending on the configuration of the UltiMate 3000 system, or three external USB hubs to the pump.

 **Important:** Thermo Fisher Scientific recommends using these USB ports only for connections to Dionex instruments. Thermo Fisher Scientific cannot guarantee correct functioning if third-party instruments are connected.

 **Important:** Thermo Fisher Scientific recommande d'utiliser les ports USB uniquement pour les raccordements aux instruments Dionex. Thermo Fisher Scientific ne peut garantir le bon fonctionnement si les instruments d'autres fabricants sont raccordés.

For information about how to connect the pump to the Chromeleon computer, see sections 3.4.1 and 3.4.2 (→ page 37).

2.5.4 Digital I/O

The digital I/O ports provide two inputs and two relay outputs that can be used to exchange digital signals with external devices. For more information, see page 38.

For information about the functions of the connector pins and pin assignment, see page 243.

2.5.5 Solvent Rack

Use this port to connect a SRD-3x00 Solvent Rack with integrated vacuum degasser to the pump. A Solvent Rack with an analytical degasser *cannot* be used with the semipreparative HPG-3200BX pump.

 **Important:** Do not substitute any other Solvent Rack for the Solvent Racks mentioned in the table on page 18.

 **Important:** Ne remplacez les dégazeurs de la série SRD-3x00 mentionnés sur la page 18 par aucun autre type de dégazeur.

For information about the pin assignment of the Solvent Rack port, see page 244. For information about how to install and operate the Solvent Rack, see the *Solvent Rack manual*.

2.6 Fluid Connections

The front panel door tilts upward to provide easy access to the fluid connections in the pump. Tilt the front cover upward. The open front panel locks in the topmost position.

⚠ Important: The open front panel door is not designed to carry weight. Therefore, you shall not place any objects on the open front panel door.

When lifting or moving the pump, always lift by the sides of the instrument. Do *not* lift the pump by front panel door. This may damage the door.

⚠ Important: Ne placez aucun objet lourd sur la porte ouverte du panneau avant. Ceci peut endommager la porte.

Lorsque vous soulevez ou déplacez la pompe, saisissez-la toujours par les côtés de l'instrument. Soulever la pompe par le panneau avant risque d'endommager la porte du panneau avant.

Capillary guides on the pump bottom facilitate routing the capillaries to devices that are located below the pump in the UltiMate 3000 system stack.

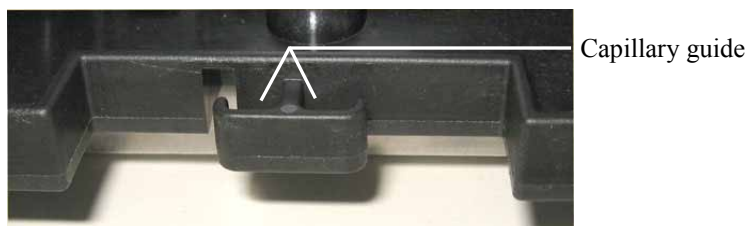

Fig. 3: Capillary guides on the pump bottom

See section 8 for the interior components and flow schematics of the pumps.

For the ...	Find the ...	See page ...
ISO-3100SD	Interior components Liquid flow path	180 181
ISO-3100BM	Interior components Liquid flow path	183 184
LPG-3400	Interior components Liquid flow path	186 187
DGP-3600	Interior components Liquid flow path	190 191
HPG-3200	Interior components Liquid flow path	194 195
HPG-3400	Interior components Liquid flow path	198 199

2.7 Rear Seal Wash System

The pump is equipped with an active rear seal wash system. Rear seal washing helps avoiding damages to the pistons, piston seals, and support rings, and thus prolongs the seal lifetime. The rear seal wash system consists of a peristaltic pump, a detector, and a reservoir containing the wash solution. The seal wash solution passes the individual components as shown in Fig. 4.

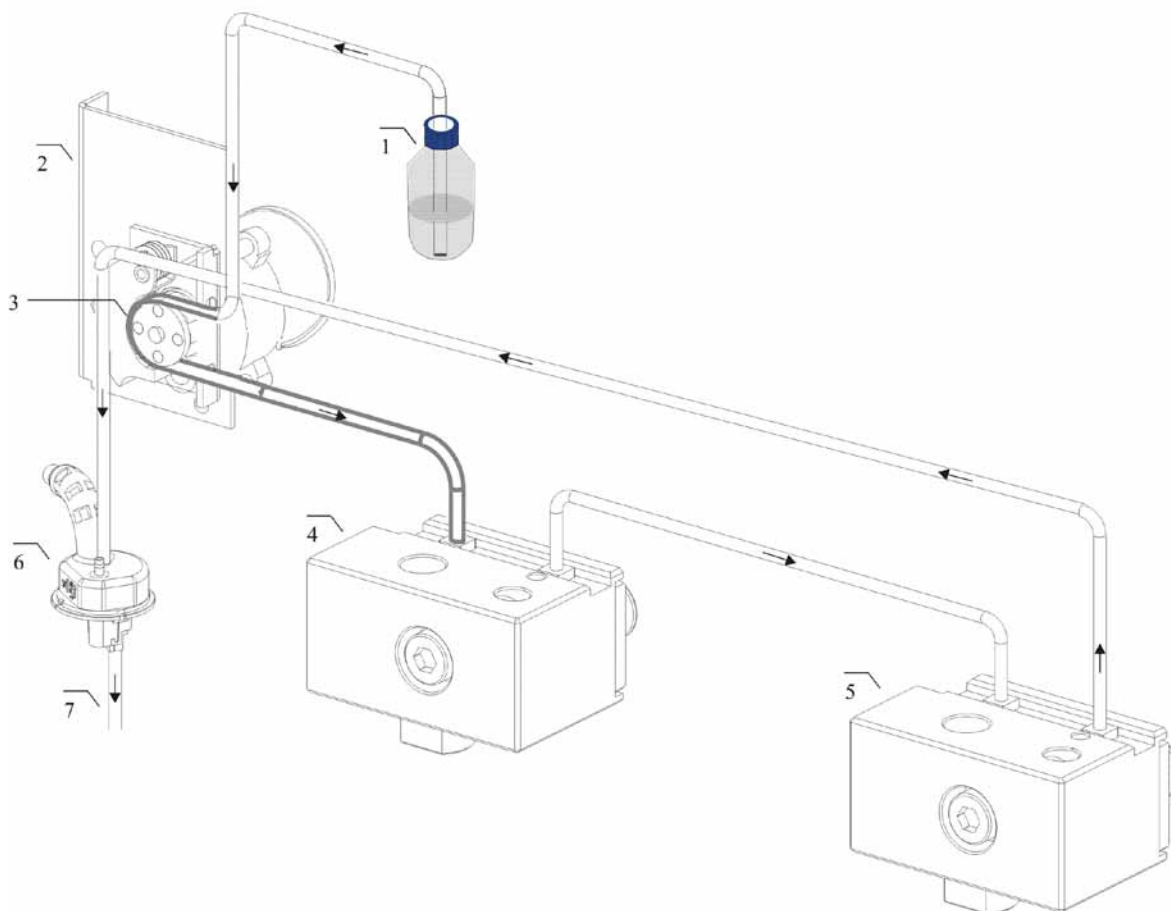

Fig. 4: Rear seal wash system (here for a pump with two pump heads)
(The arrows indicate the flow path of the wash liquid through the pump.)

No.	Description	No.	Description
1	Seal wash reservoir	4 + 5	Pump head
2	Peristaltic pump (→ page 61)	6	Detector
3	Peristaltic tubing (PharMed®) (→ page 61)	7	To waste

For information about how to set up the rear seal wash system, see page 63. For more information about how to operate the pump with rear seal washing, see section 5.5.6 (→ page 94).

2.8 Mixing System and Inline-Filter

RS pumps and SD pumps (except ISO-3100SD)

All RS and SD pumps (except ISO-3100SD) are shipped with a two-step mixing system (SpinFlow™). The system includes a capillary mixer and a static mixer. DGP-3600 pumps have to separate two-step mixing systems.

Pump	Two-step mixing system
All pumps except for HPG-3x00RS	Mixing volume: 400 µL; including: Capillary mixer (volume: 50µL) Static mixer (volume: 350 µL)
HPG-3x00RS	Mixing volume: 200 µL; including: Capillary mixer (volume: 50µL) Static mixer (volume: 150 µL)

In the capillary mixer, the solvent streams delivered by the pump are combined and premixed before they enter the static mixer. The static mixer improves the mixing quality of the combined solvent streams and thus guarantees a smoother baseline.



Fig. 5: Two-step mixing system (here in an HPG-3400SD)

In addition, mixing systems with other volumes are available for these pumps. For more information, see *Optimizing the Pump for Specific Applications* (→ page 203).

HPG-3200BX

Instead of the two-step mixing system, the HPG-3200BX has a static mixer installed (mixing volume: 750 µL).

ISO-3100SD and BM pumps

These pumps do not have a mixing system, but have an inline filter instead (→ page 167).

2.9 Purge Unit

The purge unit comprises a pressure transducer for the system pressure and purge valve with purge valve knob and outlet nozzle.

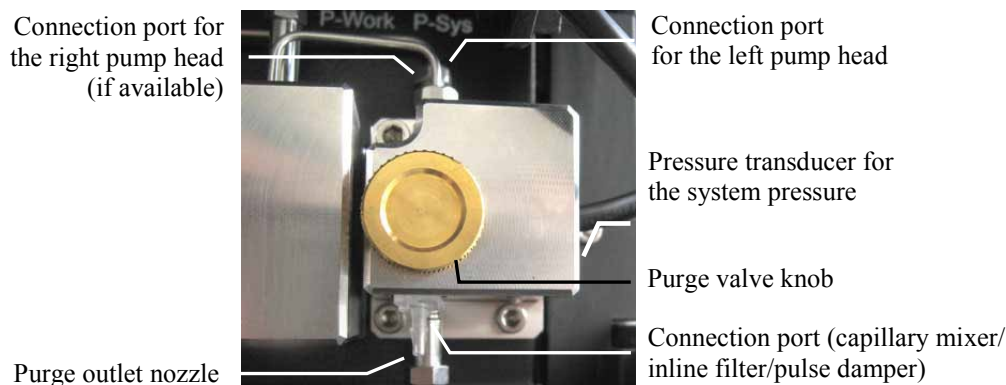

Fig. 6: Purge unit

Only HPG-3x00

In addition, the purge unit combines the eluent streams from the pump heads.

i Tip: To reduce the system pressure, you can open the purge valve. Turn the valve knob counterclockwise. If you are operating an ISO-3100BM, observe the precautions on page 101.

2.10 Leak Sensor

A leak sensor is installed inside the pump. When leak detection is enabled, the leak sensor reports a leak if liquid collects in the drip tray under the fluid connections. The Status LED on the front panel door is red. A beep sounds and a message appears on the pump display and in the Chromeleon Audit Trail.

When the leak sensor reports a leak, eliminate the cause for the leakage and dry the leak sensor (→ page 137).

Leak detection is enabled as a standard when the pump is shipped. For more information, see section 5.5.8 (→ page 97).

2.11 Vacuum Degasser

Usually, a vacuum degasser is used to remove air bubbles trapped in the solvents. LPG-3400 pumps have an inbuilt vacuum degasser. For all other pumps, consider connecting an appropriate SRD-3x00 Solvent Rack (→ page 18) or another external vacuum degasser.

i **Tips:** Normal phase eluents usually show only a low concentration of dissolved gases. Therefore, it is normally not required to use a degasser with these eluents.

A Solvent Rack with an analytical degasser *cannot* be used with the semipreparative HPG-3200BX pump.

If the UltiMate 3000 system includes an UltiMate 3000 series autosampler, you should degas also the wash liquid on a continuous basis. The procedure how to prepare and install the wash liquid lines is similar to the steps for the solvent supply (→ page 60). For more information, see the *autosampler manual*.

Observe the general precaution for degasser operation (→ page 99).

2.12 Pulse Damper

ISO-3100BM pumps have an integrated pulse damper that reduces the already low pulsation of the pump even further (→ Technical Information, page 207).

The pulse damper consists of a reservoir, filled with isopropanol, and a membrane that is placed in the mobile phase line. The damper diminishes pressure pulsations that would otherwise interfere, for example, with sensitive electrochemical detection.

Thus, an ISO-3100BM is the ideal choice for electrochemical detection applications, but also for applications for which lowest pulsation is one of the main requirements.

When operating an ISO-3100BM, also observe the general operating precautions on page 101.

2.13 Operation from Chromeleon

The pump can be controlled by the Chromeleon Chromatography Management System. To do so, an appropriate Chromeleon version and license are required.

Two modes of software control are available:

- *Direct Control*
With direct control, you select operating parameters and commands in the Commands (F8) dialog box. Direct commands are executed as soon as they are entered. For routine operation, most parameters and commands are available also on a control panel. For more information about direct control, see page 75.
- *Automated Control*
With automated control, you create a program (or PGM File). This is a list of control commands, executed in chronological order, for automated operation of the pump. You can create programs automatically with the software wizard or manually by editing an existing program. For more information about automatic control, see page 78.

 **Tip:** All software details in this manual refer to Chromeleon 6.80.

If you want to operate the pump from Chromeleon 7, refer to the following documents for information about how to perform the related processes in Chromeleon 7 (all documents are included in the Chromeleon 7 shipment):

- *Chromeleon 7 Help*—provides extensive information and comprehensive reference material for all aspects of the software.
- *Quick Start Guide*—describes the main elements of the user interface and guides you step-by-step through the most important workflows.
- *Reference Card*—provides a concise overview of the most important workflows.
- *Installation Guide*—provides basic information about module installation and configuration. For specific information about a certain module, refer to the *Chromeleon 7 Instrument Configuration Manager Help*.

Note the following:

- Chromeleon 7 terminology is different from the terminology used in Chromeleon 6.80. For details, refer to the 'Glossary - Chromeleon 7,' which is available in the Documents folder of your Chromeleon 7 installation.
- Chromeleon 7 may not yet support all functions supported in Chromeleon 6.80.

2.14 Wellness, Predictive Performance, and Diagnostics

System Wellness monitors the health of the pump. Therefore, the pump supports several performance and reliability features that can help you detect small problems before they turn into big ones:

- Internal monitoring of all mechanical operations
- Automatic self test upon power up
- Leak sensor (→ page 28)
- Active rear seal wash system (→ page 26)

When an error is detected, the Status LED on the front panel door is red and a message appears on the pump display (→ page 117).

When the pump is operated from Chromeleon, additional functions for estimating the lifetime of consumables and monitoring and recording service and (re)qualification information (= predictive performance; → page 103) are available. To check the performance of certain pump components and the overall performance of the instrument, Chromeleon also supports diagnostics functions for the pump (→ page 105).

3 Installation

3.1 Facility Requirements

The installation site must meet the following requirements:

- The main power switch and the main power receptacle are on the rear panel. Make sure that
 - ◆ Free and unrestricted access to the main power switch is ensured at all times.
 - ◆ The power cord of the device can be easily reached and disconnected from the power line at all times. Provide sufficient space behind the device to unplug the cable.
- Make sure that the installation site meets the power and environmental specifications listed in the Technical Information section (→ page 207).
- Install the pump in the laboratory on a stable surface. Make sure that the position is horizontal and free of vibrations.
- Make sure that the surface is resistant to solvents.
- Avoid locations with extreme changes in temperature. Also, avoid locations with extreme direct sunlight and high humidity.
- Allow sufficient clearance behind and to the sides of the pump for ventilation.

3.2 Unpacking

All electrical and mechanical components of the pump are carefully tested before the device is shipped from the factory. After unpacking, inspect the device for any signs of mechanical damage that may have occurred during transit.

i **Tips:** Immediately report any shipping damage to both, the incoming carrier and Thermo Fisher Scientific. Shipping insurance will compensate for the damage only if reported immediately.

Keep the original shipping container and packing material. They provide excellent protection for the pump in case of future transit. Shipping the pump in any other packaging automatically voids the product warranty.

1. Place the shipping container on the floor and remove the accessories kit, power cord, and solvent reservoir.

2. Grasp the pump by the sides. Slowly and carefully, pull the instrument out of the shipping container and place it on a stable surface.

⚠ Important: To prevent the pump from falling, grasp the pump by the sides, and then lift the pump together with the foam spacers out of the shipping container. Do not lift the pump by the foam spacers or the front panel.

⚠ Important: Afin d'empêcher la pompe de tomber, saisissez-la par les côtés. Ne soulevez la pompe à l'aide du matériau d'emballage ou par la porte du panneau avant.

3. Remove the foam spacers, and then remove the polythene packaging.
4. Tilt the front panel upward and remove the foam inserts securing the front panel door during shipment.
5. Before connecting the pump to the power source, wait approximately four hours to allow the instrument to come to room temperature and to allow any condensation that might have occurred during shipping to evaporate. After 4 hours, check the pump; if condensation still exists, allow the pump to continue to warm up (without connecting it to the power source) until the condensation is completely gone.

3.3 Positioning the Pump in the UltiMate 3000 System

If the pump is part of an UltiMate 3000 system, stack the individual modules (→ Fig. 7) and interconnect them on the rear panel (→ Fig. 8). The arrangement of the system modules depends on the application.

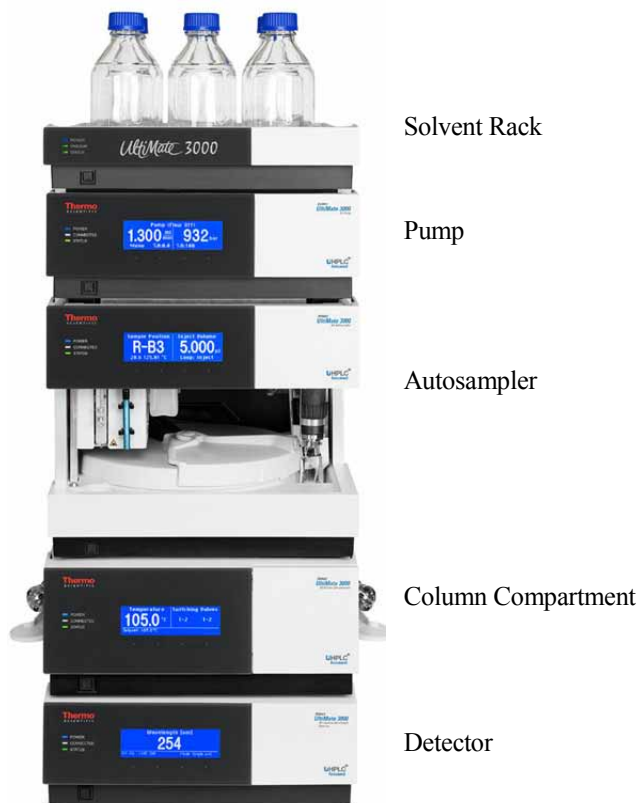

Fig. 7: Module arrangement for an UltiMate 3000 system (example)

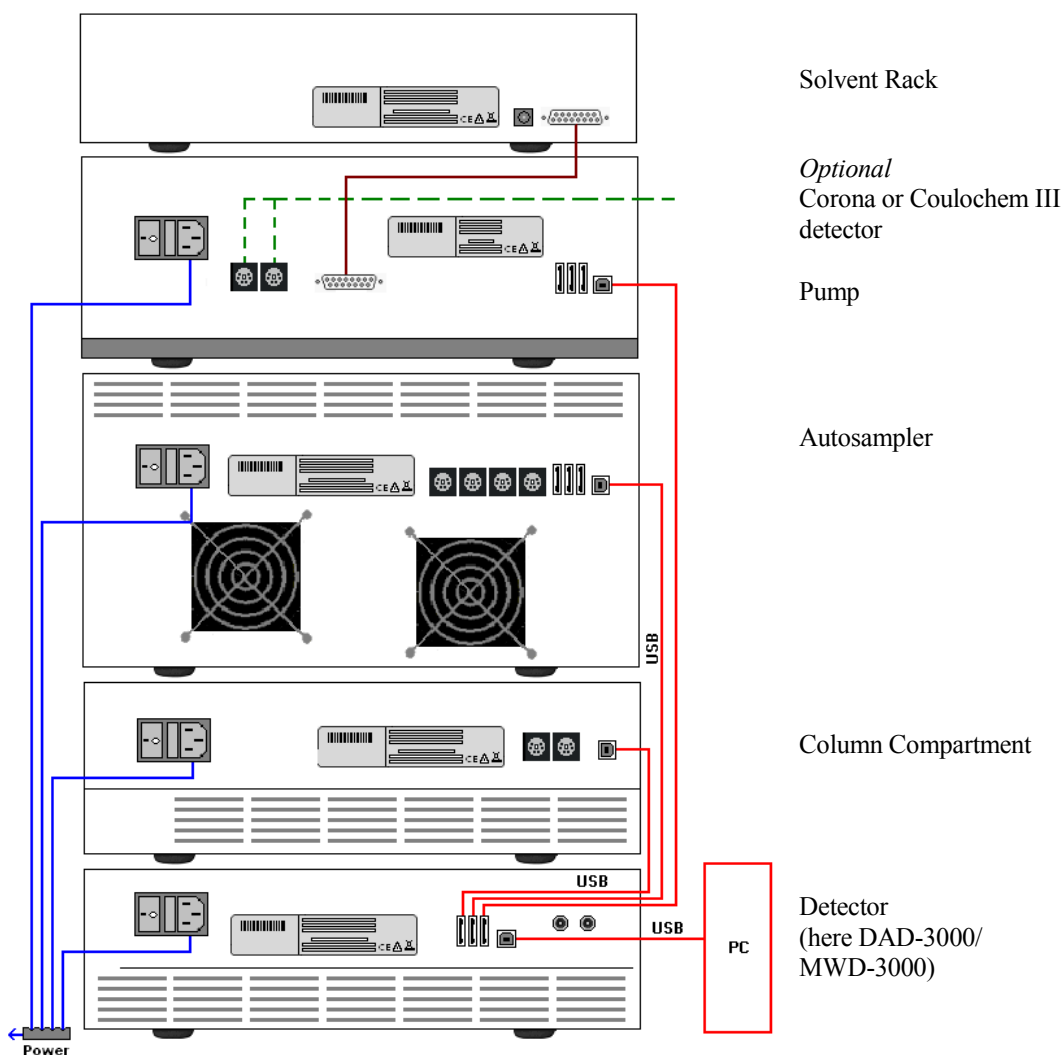

Fig. 8: Example for the rear panel connections on an UltiMate 3000 system

Apart from the Solvent Rack, all modules of the UltiMate 3000 system can be connected separately to the Chromeleon computer by using the USB port on the rear panel of the instrument. However, Thermo Fisher Scientific recommends interconnecting all modules, and then connecting the system to the Chromeleon computer with only one connection.

For systems with a DAD-3000(RS) or MWD-3000(RS), you can use *only* the hub on the detector for the connection.

For systems with a VWD-3x00(RS), use *only* the hub on the pump.

3.4 Connecting the Pump

3.4.1 General Information

If you want to operate the pump from Chromeleon

Before you connect the pump to the USB port on the Chromeleon computer and turn on the pump power, verify that Chromeleon is installed on the computer and that the license code is entered. Only if you install Chromeleon first, the USB driver for the pump is automatically loaded and the Windows® operating system can detect the pump when the power is turned on.

3.4.2 Connecting the USB Cable

Connect the pump to the Chromeleon computer via the USB ports on the rear panel (→ Fig. 2, page 22). Select one of the following alternatives:

- Connect the pump directly to the USB port on the Chromeleon computer.
- Connect the pump to an internal USB port on another module in the UltiMate 3000 system that is connected to the Chromeleon computer (→ page 36).
- Connect the pump to the Chromeleon computer via an external USB hub. (However, this may be the source for communication problems, depending on the quality of the hub.)

To ensure trouble-free operation, use only these cables for the connection (both cables are provided in the accessories kit for the pump):

USB Cable	Part No.
USB cable, type A to type B, high speed USB 2.0 (cable length: 5 m)	6911.0002
USB cable, type A to type B, high speed USB 2.0 (cable length: 1 m)	6035.9035

 **Tip:** The USB standard limits the USB cable length to 5 meters. Each USB device can be separated from the PC or next USB hub by no more than 5 meters

3.4.3 Connecting the Power Cord

Use the power cord shipped with the device to connect the module to the main power source. Connect the power cord from the main power receptacle on the rear panel (→ Fig. 2, page 22) to a grounded power source. No manual adjustment is required to adapt the line voltage to local voltage requirements.



Warning: Never use a power cord other than the power cords provided for the device.

Do not use multiple sockets or extension cords. Using defective multiple sockets or extension cords may cause personal injury or damage to the device.



Avertissement: Utilisez uniquement les cordons d'alimentation électrique spécifique à l'instrument.

N'utilisez pas des blocs multiprise ou des câbles prolongateurs. Cela pourrait entraîner des blessures corporelles ou endommager l'instrument.

3.4.4 Connecting the Solvent Rack and Digital I/O

Solvent Rack

Connect the Solvent Rack port on the rear panel of the pump to the 15-pin D-Sub connector on the rear panel of the Solvent Rack if applicable. The appropriate connection cable is included in the accessories kit of the Solvent Rack.

Digital I/O

To connect external devices to the digital I/O ports on the pump use the appropriate mini-DIN cables (part no. 6000.1004). The cable is available from Thermo Fisher Scientific.



Tip: To connect an OAS-3x00TXRS Open Autosampler to the pump, special connection cables are required. These cables are included in the autosampler shipment. The UltiMate 3000 pump model, detector, and pump/detector combination determine which digital I/O port on the pump is to be used for connecting the autosampler. For details about how to connect the autosampler to the pump, see the *autosampler manual*.

1. Plug the 6-pin connector of the mini-DIN cable into the Digital I/O port 1 (or 2). For information about the functions of the connector pins and pin assignment, see page 243.
2. For each relay output or digital input to be used, connect the appropriate signal wire and ground wire to the corresponding connectors on the external device (→ documentation provided with the external device).

3. When setting up the pump in the Chromeleon **Server Configuration** program (→ page 43), select the corresponding relay outputs on the **Relays** page (→ page 49) and the digital inputs on the **Inputs** page (→ page 50).

i **Tip:** If you want to connect a Corona or Coulochem III detector to the pump, refer to page 52 for details.

3.5 Setting Up the Pump in Chromeleon

This section provides brief instructions for setting up the pump in Chromeleon. For details, see the *Chromeleon Help*. For information about how to set up the pump in DCMSLink, see section 3.6 (→ page 51).

i **Tip:** When the pump is connected to the Chromeleon computer, verify that the Chromeleon software is installed *before* turning on the pump power for the first time. Only then, the USB driver for the pump is automatically loaded and the Windows operating system can detect the pump when the power is turned on.

3.5.1 Loading the USB Driver for the Pump

1. Turn on the power to the Chromeleon computer if it is not yet already on.
2. Under Windows Vista® (Windows® XP, Windows® 7, or Windows® Server 2008) log on as a
 - Local administrator if the computer is a local computer.
 - User with local computer administrator privileges if the computer is a network computer.
3. Open the **Chromeleon Server Monitor** program by double-clicking the Chromeleon Server Monitor icon  on the Windows taskbar.

If the Server Monitor icon is not on the taskbar, click **Start** on the taskbar, point to **Programs** (or **All Programs**, depending on the operating system), point to **Chromeleon**, and then click **Server Monitor**.

4. Click **Start** to start the server.
5. Click **Close** to close the Server Monitor window. The Server Monitor icon  appears on the taskbar.

i **Tip:** Clicking the **Quit Monitor** button quits (exits) the Server Monitor program, but does not stop the server. To stop the server, click **Stop**.

6. Turn on the main power switch on the rear panel of the pump.
7. *Depends on the operating system*

Windows Vista, Windows 7, and Windows Server 2008

will automatically detect the new pump and perform the USB installation. If Windows fails to detect the pump and launches a wizard instead, this indicates that you connected the pump to the computer and turned on the power for the first time *before* you installed Chromeleon.

To resolve the problem:

- a) Click **Cancel** to exit the wizard.
- b) Turn off the pump.
- c) Install Chromeleon.
- d) Turn on the power to the pump. Windows will now detect the pump and install the USB software for the pump automatically.

Windows XP

will automatically detect the new pump and launch the **Found New Hardware Wizard**, which guides you through the USB installation. Select the following options:

- a) If asked whether Windows can connect to Windows Update to search for software, select **No, not this time**.
- b) Accept the default option (**Install the software automatically**) and click **Next>**.
- c) Click **Finish** when the wizard reports that the software for the pump has been installed.

If Windows fails to detect the pump and a message box asks for a USB configuration file (cmwdmusb.inf), this indicates that you connected the pump to the computer and turned on the power for the first time *before* you installed Chromeleon. To resolve the problem:

- a) Click **Cancel** in the Windows message box.
- b) Turn off the pump.
- c) Install Chromeleon.
- d) Turn on the power to the pump. Windows will now automatically detect the pump and launch the **Found New Hardware Wizard**.

3.5.2 Installing the Pump

After the USB software for the pump has been installed (→ page 40), install and configure the pump in Chromeleon:

1. Start the Chromeleon Server Monitor and the Chromeleon server if they are not yet running (→ page 40).
2. Start the Chromeleon Server Configuration program by clicking **Start** on the taskbar. Point to **Programs** (or **All Programs**, depending on the operating system), point to **Chromeleon**, and then click **Server Configuration**.
3. If necessary, click the plus sign next to the server name to display the items underneath.
4. Select the timebase to which the pump will be assigned, or create a new timebase (on the **Edit** menu, click **Add Timebase**).
5. Open the **Add device to timebase** dialog box. To do so, click **Add Device** on the **Edit** menu or right-click the timebase and click **Add Device** on the menu.
6. On the **Manufacturers** list, click **Dionex HPLC: UltiMate 3000** and on the **Devices** list, click the pump you want to add, for example, **HPG-3x00RS Pump** or **LPG-3400SD Pump**.
7. The configuration pages for the pump are opened. On each configuration page, verify that the settings are correct and select additional settings if needed. For a description of the pages, see section 3.5.3.1 (→ page 43).
8. On the **File** menu, click **Save Installation** and then close the Server Configuration program.

3.5.3 Configuring the Pump

3.5.3.1 Initial Installation

On each configuration page for the pump, check and change the settings if necessary and select additional settings if needed. You may reopen the configuration pages later again to change the settings (→ page 51).

i **Tip:** Changing the settings for a specific application in the Commands dialog box, in a program file (PGM), or on a control panel will not change the standard settings on the configuration pages.

For additional information about a page, click Help.

General Page

Display general information about the pump:

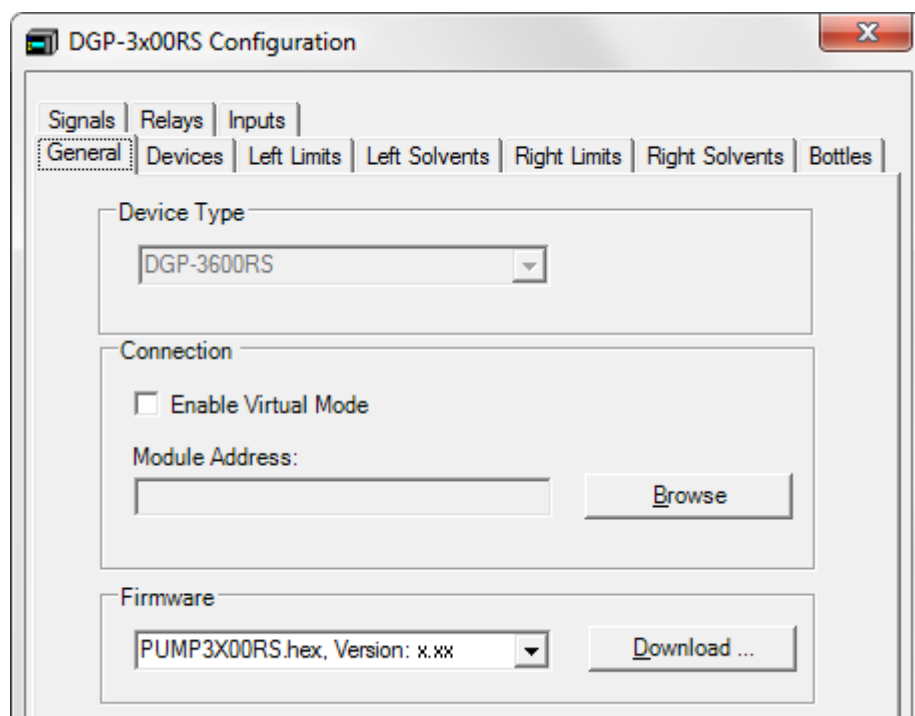

Fig. 9: General page

- **Device Type**
Indicates the pump model.
- **Enable Virtual Mode**
This check box should be cleared because Chromeleon only simulates the functions of the pump when the virtual mode is active. If the Virtual Mode is enabled, the **Module Address** box will be unavailable.

- **Module Address**

Select the module address of the pump if necessary. Click **Browse** and then double-click the pump that you want to use on the **Device List**. The address is automatically entered in the Module Address box. The button appears dimmed if the virtual mode is enabled.

- **Download**

Click the button to transfer the firmware version available for the pump in Chromeleon to the pump. The button appears dimmed if the virtual mode is enabled.

The pump is shipped with the most recent firmware version. If a firmware update is ever required, follow the steps in section 7.12 (→ page 177).

Devices Page

The pump type determines the settings and options on this page.

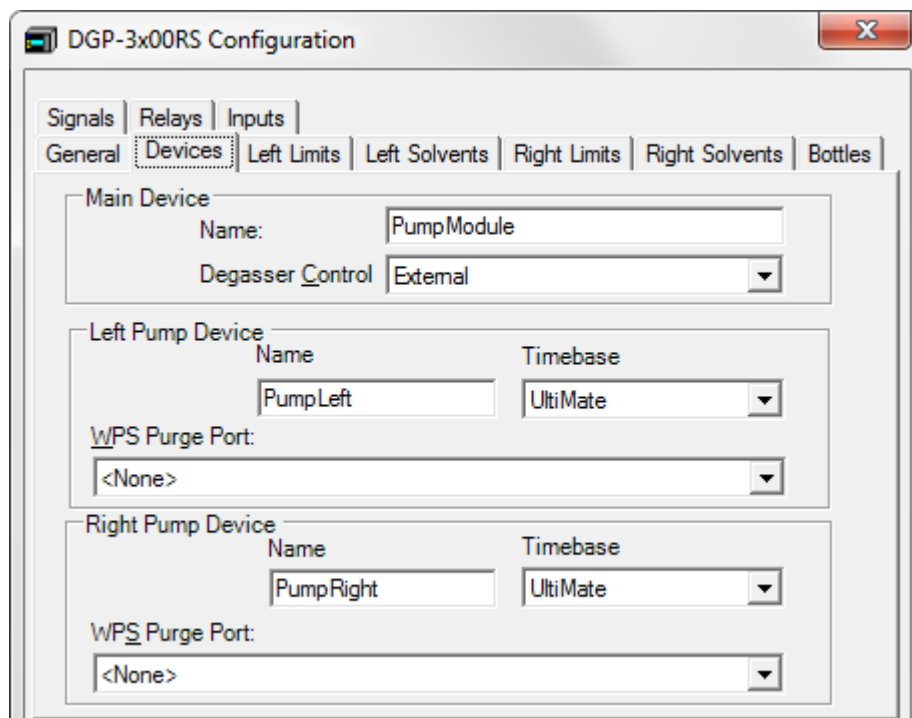

Fig. 10: Devices page (here for a DGP-3600RS)

- **Main Device**

- **Name** (default name: *PumpModule*)

Displays the name used to identify the pump in the installation environment and in the Chromeleon client. To control the pump with the existing control panels, accept the default name. If you enter a different name, you may have to re-link the controls on the control panels and edit the name in the program files.

Under *PumpModule*, the following commands and properties are displayed, for example, in the **Commands** dialog box (→ page 75):

- General pump properties and commands, such as, Connect, Connected, Disconnected, and Degasser.

- Specific groups of pump properties and commands, such as **Pump** or **PumpLeft** and **PumpRight** (see table further down in this section), with the flow-related properties and commands.
- ◆ **Degasser Control**
Indicates whether the vacuum degasser in a LPG-3400 or in a SRD-3x00 Solvent Rack can be operated and monitored. If it can, the related commands and properties are available, for example, in the Commands dialog box.
 - ◆ Click **Internal** if the pump is a LPG-3400.
 - ◆ Click **External** if a SRD-3x00 Solvent Rack is connected to the pump.
 - ◆ In all other cases, click **None**.
- *Depending on the pump type*
Pump Device or Left Pump Device and Right Pump Device (DGP-3600)

◆ **Name**

The following names are the default names:

Pump Type	Default Name		
	Pump Device Name	Left Pump Device Name	Right Pump Device Name
ISO-3100 HPG-3x00 LPG-3400	Pump	----	----
DGP-3600	----	PumpLeft	PumpRight

Under this name, specific groups of properties and commands are listed in the **Commands** dialog box, for example, the flow-related properties and commands of the pump. There you can set, for example, the flow rate and partial flows, and change the upper and lower pressure limits.

To control the pump with the existing control panels, accept the default name. If you enter different names, you may have to re-link the controls on the control panels and edit the names in the program files.

◆ **Timebase (only DGP-3600)**

Select the timebase to which the related the pump is assigned. The standard setting is the timebase in which the pump is installed. To change the setting, click the arrow next to the Timebase box and click a different timebase on the list. The list shows all timebases for that server.

◆ **WPS Purge Port¹**

If the UltiMate 3000 system includes a WPS-3000RS or WPS-3000SL autosampler, specify whether the pump is purged through the membrane pump of the autosampler. The standard setting is <None>.

◆ *All pumps except DGP-3600*

Click **UM3WPS_PURGE0** to connect the pump fluidically with the autosampler.

◆ *DGP-3600*

To connect both pumps of a DGP-3600 fluidically to the autosampler, click **UM3WPS_PURGE0** for one pump and **UM3WPS_PURGE1** for the other pump. To connect only one pump to the autosampler, click **UM3WPS_PURGE0** for the pump to be connected and click <None> for the other pump.

For more information about how to purge the pump by using the autosampler, see page 65.

¹ For patent reasons, this function must not be used in the following countries: China, Germany, Great Britain, Japan, and the USA.

Limits page or Left Limits and Right Limits pages (depending on the pump type)

Shows the allowed ranges for the flow rate and the pressure. You can change the upper and lower limits within the allowed ranges. In addition, you can change the pressure unit.

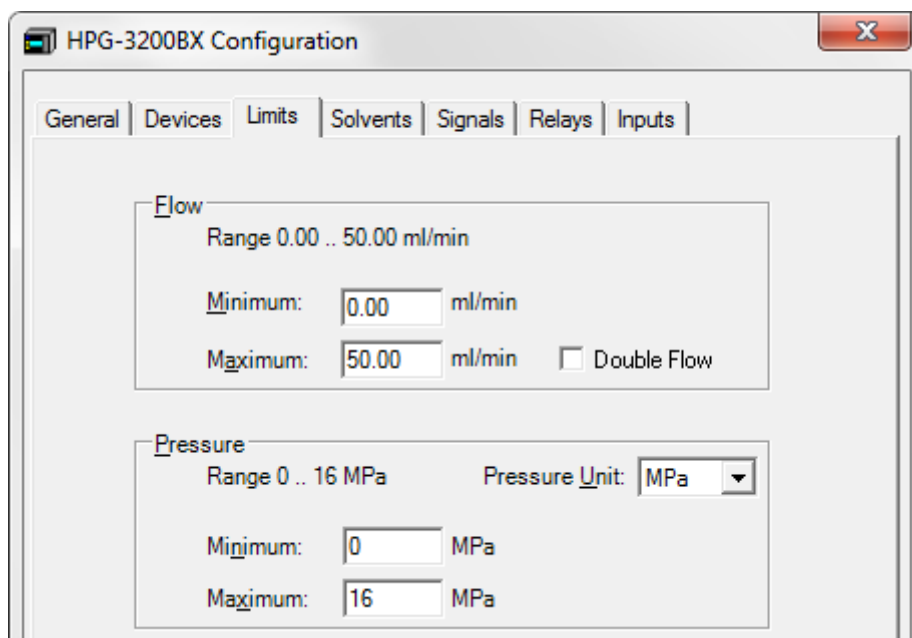

Fig. 11: Limits page (here for an HPG-3200BX)

- **Flow**
Shows the allowed flow range.
Enter a new value in the **Minimum** and/or **Maximum** box to change the limits for the flow rate within the allowed range.
Double Flow—Only HPG-3200BX
The check box is cleared by default. Select the check box if you want the pump to deliver flow rates above the flow rate that is usually allowed. When the check box is selected, both pump blocks are used for the delivery so that the maximum allowed rate is doubled (→ page 102).
- **Pressure**
Shows the allowed pressure range.
Enter a new value in the **Minimum** and/or **Maximum** box to change the pressure limits within the allowed range.
Click the arrow of the **Pressure Unit** box and select a different pressure unit (psi, bar, or MPa) on the list if required.

These values are the absolute limits. Within these limits, you can set specific limits on a control panel or in a program file.

Solvents page *or* **Left Solvents** and **Right Solvents** pages (depending on the pump type)

Check and change the number of solvents delivered by the pump and the solvent names if necessary.

- **Number of Solvents**

Indicate how many solvents are delivered by the pump. The pump type determines how many solvents can be delivered.

Pump Type	Max. Number of Solvents
ISO-3100	1
HPG-3200	2
LPG-3400, HPG-3400	4
DGP-3600	2 x 3

- **Solvent Names**

Enter a name for each connected solvent. A solvent name can contain a maximum of 30 characters. The names of the solvents appear, for example, in the gradient display of the online control panel and in the report.

Bottles page (only DGP-3600)

Check and, if necessary, change the settings for solvent consumption monitoring and waste liquid level monitoring:

- **Share Eluent Bottles**

The check box is selected by default. Accept this setting if both pumps of the DGP-3600 are connected to the same solvent reservoirs.

If the check box is selected, Chromeleon assigns the eluent properties, **%A/B/C_RemainTime** and **%A/B/C_WarningLimit**, the same values for each pump. (The eluent properties are available, for example, in the Commands dialog box under **PumpModule > [Pump Device Name]** (→ page 45).)

Clear the check box if the pumps are connected to different solvent reservoirs. With this setting, Chromeleon supports the two eluent properties separately for each pump.

- **Share Waste Bottle**

The check box is selected by default. Accept this setting if both pumps of the DPG-3600 are connected to the same waste container.

If the check box is selected, Chromeleon assigns the two waste properties, **Waste_RemainTime** and **Waste_WarningLimit**, the same values for each pump. (The waste properties are available, for example, in the **Commands** dialog box under **PumpModule > [Pump Device Name]** (→ page 45).)

Clear the check box if the pumps are connected to different waste containers. With this setting, Chromeleon supports the two waste properties separately for each pump.

For more information about liquid level monitoring, see page 106.

Signals Page

The **Signals** page lists all available signals. Select a check box to enable the signal. If a check box is cleared, the signal will not be available in Chromeleon. To change a signal name or the scaling factor, overwrite the existing entry directly in the corresponding line. To change the pressure unit, make your selection on the Limits page.

The signal for the pump pressure (**Pump_Pressure**) is selected by default (with a DGP-3600, **Pump_Pressure_Left** and **Pump_Pressure_Right**). Accept this setting if you want to record the pump pressure. Chromeleon then generates the appropriate channels for data acquisition. For more information, see section 5.5.5 (→ page 94).

Relays Page

The Relays page lists all available relays.

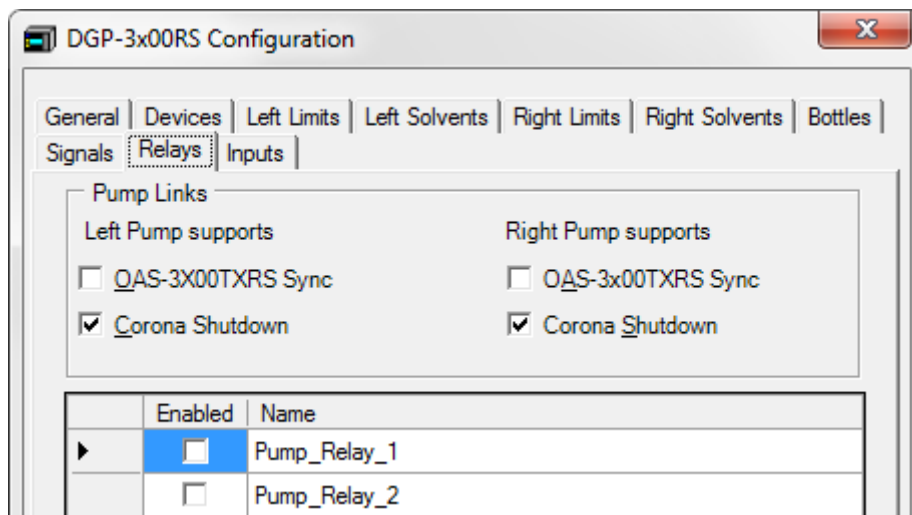

Fig. 12: Relays page (here for a DGP-3600 pump)

In the **Pump Links** group, the **Corona Shutdown** check box is selected by default. If the UltiMate 3000 system includes an OAS-3x00TXRS Open Autosampler and a LPG-3400 or DGP-3600 pump, select the **OAS-3X00TXRS Sync** check box. Only then, the injection command will be synchronized with the pump strokes.

i **Tip:** For information about how to synchronize the inject command of a WPS-3000 or ACC-3000 autosampler with the strokes of a low-pressure gradient pump, see section 5.5.2 (→ page 91).

Keep the following in mind:

- If **OAS-3X00TXRS** and/or **Corona shutdown** are selected, the related relays are controlled by the pump and are no longer available in Chromeleon for individual control. If you try to use a relay for more than one function, a message will alert you and you have to change the selection as appropriate.
- With a DGP-3600, synchronization of the injection command of the OAS-3x00TXRS with pump strokes is possible *only* for one pump. To activate stroke synchronization, you have to clear one of Corona shutdown check boxes *first*. Clear the check box for the pump for which Corona shutdown shall not be supported.
- If the relays are available for control from Chromeleon, select a check box to enable the corresponding relay. If a check box is cleared, the relay will not be available in Chromeleon. To change a relay name, overwrite the existing name directly in the corresponding line. For more information about the relays, see page 23.

Inputs Page

The **Inputs** page lists all available remote inputs. Select a check box to enable the remote input. If a check box is cleared, the input will not be available in Chromeleon. To change an input name, overwrite the existing name directly in the corresponding line.

If the UltiMate 3000 system includes an OAS-3x00TXRS Open Autosampler and a LPG-3400 or DGP-3600 pump, you have to activate an input here to make the input available for selection in the Chromeleon **Properties** dialog for the autosampler. To make sure that the injection response signal is properly transferred, additional settings are required on the autosampler and in Chromeleon, in the **Properties** dialog for the autosampler. For details, see the *autosampler manual*.

3.5.3.2 Changing the Configuration Properties

To change the standard configuration settings, reopen the configuration pages:

1. Start the **Server Configuration** program (→ page 42).
2. Right-click the pump in the timebase and click **Properties** on the menu.
3. Change the settings as needed. For a description of the pages, see section 3.5.3.1 (→ page 43).
4. To save the configuration, click Save Installation on the File menu and then close the Server Configuration program.

3.6 Setting Up the Pump in DCMSLink

1. Install and configure the DCMSLink-Software (→ *DCMSLink Installation Guide*). The Guide is provided on the DCMSLink DVD in the *Additional Documents\DCMSLink User Documents* folder.
2. Open the Chromeleon Server Configuration program (→ *DCMSLink Installation Guide*).
3. Add the pump to a timebase. The steps in section 3.5.2 apply equally (→ page 42).
4. Configure the pump. The steps in section 3.5.3 apply equally (→ page 43).

For more information about DCMSLink, refer to *DCMSLink Help* and the *DCMSLink Quick Start Guide*. The Quick Start Guide is also provided on the DCMSLink DVD.

3.7 Connecting a Corona or Coulochem III Detector

Note the following if you want to connect a Corona or Coulochem detector to the pump:

- To connect the detector to a digital I/O port on the rear panel of the pump, use the 6-pin mini-DIN signal cable (part no. 6000.1004).
- In an UltiMate 3000 XRS system, the pump model and the pump/detector combination determine which digital I/O port on the pump is to be used for connecting the detector. Observe the information in the *autosampler manual*.
- For information about how to connect the detector to the pump, follow the instructions in the *Chromeleon Help*. The Help provides separate sections for connecting these detectors to an UltiMate 3000 system pump, including details about the appropriate cabling and settings required in the Server Configuration program.
- *Only Corona*
When the pump and detector are connected and configured as described in the *Chromeleon Help*, pumping is stopped and an error message appears on the pump display and in the Chromeleon Audit Trail ('An emergency stop was requested over the digital input line') if an error occurs in the detector. Check the detector and take appropriate remedial action (→ *Detector manual*).
- *Only Coulochem III*
When the pump and detector are connected and configured as described in the *Chromeleon Help*, the detector cell is automatically turned off when the pump flow is zero. Also observe the information on page 101.

For more information, see the *Chromeleon Help*.

4 Preparation for Operation (Startup)

4.1 Overview of Actions

⚠ Important: The pump is filled with 2-propanol when being shipped from the factory. During initial operation of the device, make sure that the solvents used are miscible with 2-propanol. Otherwise, use an appropriate intermediate solvent.

⚠ Important: La pompe est stockée sous 2-propanol lorsqu'elle est expédiée depuis l'usine. Lors du démarrage initial de la pompe, assurez-vous que les solvants utilisés sont miscibles. Dans le cas contraire, utilisez un solvant intermédiaire approprié. Même d'infimes particules peuvent endommager le système.

After you have unpacked, positioned and connected the pump (→ sections 3.1 through 3.4, page 33 and following pages), prepare the pump for operation:

1. *If the UltiMate 3000 system includes a SRD-3x00 Solvent Rack*
Connect the 15-pin D-Sub port on the rear of the Solvent Rack with the Solvent Rack port on the rear of the pump (→ page 24).
2. *If you want to connect a Corona or Coulochem III detector to the pump*
Refer to section 3.7 for details (→ page 52).
Before you attach the column and cell, flush the system with several volumes of the mobile phase to be used.
3. Connect the pump to the other modules of your UltiMate 3000 system, as required by your application.
When you connect capillaries to the pump, observe the general precautions on page 55.
4. Connect the solvent reservoirs, and then connect the solvent supply lines to the degassing channels or pump inlet, depending on the pump type (→ page 58).
5. Connect drain tubing (→ page 62).
This is a *must* as also the seal wash solution is directed to waste through the drain system. If drain tubing is not connected, modules that are located below the pump in the UltiMate 3000 system stack, may suffer severe damage from the liquid leaving the drain port.
6. Set up the seal wash system and flush the system with the seal wash solution (→ page 63).
7. Turn on the power to the pump (→ page 71).

8. *If you want to operate the pump from Chromeleon*
 - ◆ Set up the pump in Chromeleon if it is not already set up (→ page 39).
 - ◆ If you want to operate the degasser of a LPG-3400 or a SRD-3x00 Solvent Rack from Chromeleon, open the Properties dialog for the pump, click the **Devices** tab, and verify that the **Degasser Control** setting is correct (→ page 44).
 - ◆ Link the autosampler of the UltiMate 3000 system with the pump as appropriate (→ page 91).
9. Purge the pump (→ page 65).
10. Check and change the leak sensor setting if necessary (→ page 97).
11. Adjust the brightness and contrast of the front panel display if necessary (→ page 97).
12. Before starting sample analysis, equilibrate the entire system (→ page 69).

4.2 Connecting and Handling Capillaries

When you connect capillaries to the pump, observe the following general precautions:

- Observe the precautionary statements for capillaries and capillary connections in section 1.2.2 (→ page 4).
- When you connect capillaries, make sure that the connectors are free from contaminants. Even minute particles may cause damage to the system.
- Different fitting systems are used in an UltiMate 3000 system. Install the capillaries and fittings only at the positions for which they are intended.
- Use only the capillaries shipped with the device and original Dionex spare capillaries.
- Thermo Fisher Scientific recommends using Viper capillary connections whenever possible. When using Viper capillaries, observe the information in the instructions shipped with the capillary.
- Different fitting systems are used in the UltiMate 3000 pumps. Depending on the fitting connection, observe the following:
 - ◆ *Viper connections - Depending on the Viper fitting:*



*Fig. 13: Viper fitting connections
(left: with knurled screw (example), right: with torque tothing)*

i **Tips:** You can reuse capillaries with Viper fitting connections also for a different connection.

If the knurled screw is a black screw (as shown in Fig. 13), you can remove it from the capillary and reattach it later again.

◆ *Viper fitting with torque tothing (RS pumps)*

Loosen or tighten these Viper connections *only* with your hand and by using the special installation tool (part no. 6040.2314). The installation tool is provided in the accessories kit for the RS pumps.

When tightening a connection, first tighten the connection hand-tight. Then, use the tool to tighten the connection further. Use the tool as shown in Fig. 14 (→ page 56). Tighten until you hear a click, indicating that the torque limitation has been reached. Loosen a connection in the same way.

If leakage is observed at the connection port, remove the capillary, clean the capillary ends carefully by using a cloth or tissue wetted with isopropanol, and reinstall the capillary. If the connection continues to leak, install a new Viper capillary.

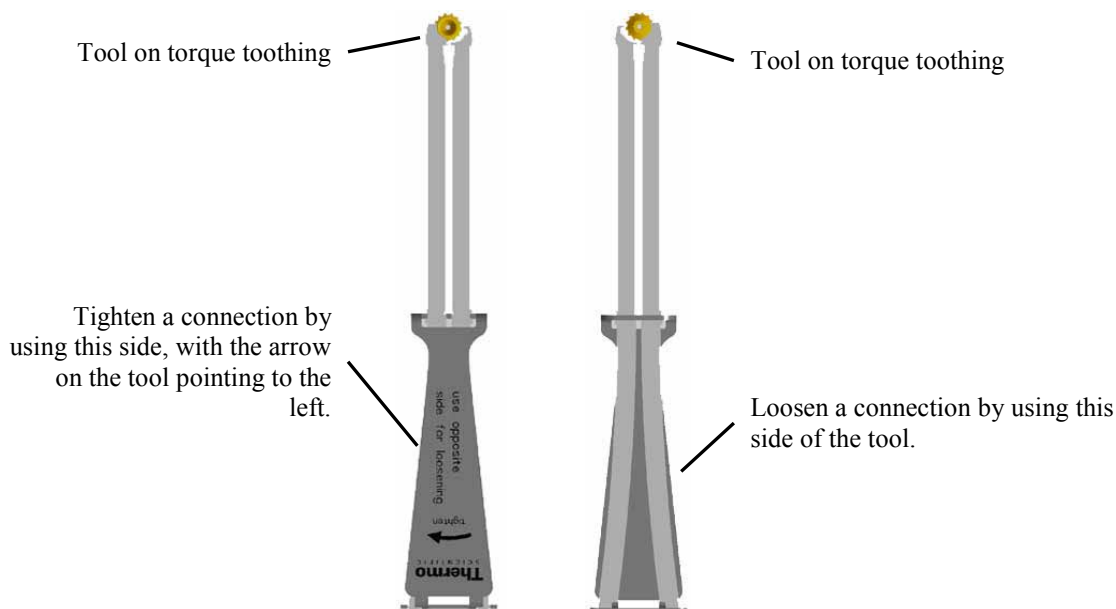

Fig. 14: Installation tool for Viper capillaries with torque tothing

◆ *Viper fitting with knurled screw*

Loosen or tighten these Viper connections *only* by using the black knurled screw and *only* with your hand (do *not* use tools).

First, tighten the screw hand-tight. If the connection leaks, tighten the screw a little more. If leakage continues, remove the capillary, clean the capillary ends carefully by using a cloth or tissue wetted with isopropanol, and reinstall the capillary. If the connection continues to leak, replace the Viper capillary.

◆ *Conventional fitting connections (non-Viper)*

Do not overtighten these fitting connections. The torque should not exceed 3 Nm for steel capillaries or 1.6 Nm for titanium capillaries. If you observe leakage on the connection, tighten a little further.

If leakage still exists, clean the connection port with a cleaning swab (part no. 6040.0006). Replace the capillary and/or fitting if this does not eliminate the problem.

To avoid increased dead volume or damage to the system and leakage, reuse fittings and ferrules only for the same capillary connection.

4.3 Solvent Reservoirs

For the secure and functional positioning of the solvent reservoirs, the UltiMate 3000 system series includes Solvent Racks with and without integrated vacuum degasser (→ page 18). All Solvent Racks are shipped with solvent reservoirs and appropriate tubing, including frit holders with filter frits.



Fig. 15: Pump with Solvent Rack

If the UltiMate 3000 system includes an UltiMate 3000 series autosampler, you should degas also the wash liquid on a continuous basis, for example, by using the vacuum degasser of either the LPG-3400 or an appropriate SRD-3x00 Solvent Rack. The procedure how to prepare and install the wash liquid lines is similar to the steps for the solvent supply. For more information, see the *autosampler manual*.

4.3.1 General Notes

When connecting the solvent reservoirs, observe the following general precautions:

- Before using the solvent reservoirs for the first time, rinse them thoroughly by using high-purity solvents.
- Always install filter frits on the solvent supply lines. This prevents contaminants from reaching the HPLC system that may increase wear and cause damage to the system.
- Regularly check the filter frits for permeability. This is especially important when using aqueous solvents. Aqueous solvents may contaminate the filters with algae and other microorganisms that deposit on the filter frits. Therefore, use fresh the solvents at regular intervals. Clean the reservoirs thoroughly before refilling them. Replace the filter frits as necessary.

- As a standard, filter holders with stainless steel frits are provided in the accessories kit of the Solvent Rack. Keep the following in mind:
 - ◆ *The system includes a biocompatible pump*
If the UltiMate 3000 system includes a *biocompatible* pump (→ page 19), replace the stainless steel frits with the frits from the accessories kit of the biocompatible pump. Open the filter holder and remove the filter frit. When placing the new filter frit into the bottom part, make sure that the frit is in a level position (avoid tilting the frit).
 - ◆ *The system includes a semipreparative pump*
If the system includes a semipreparative pump, use the filter holder and filter frits provided in the accessories kit of the semipreparative pump.
- Make sure that the tubing connecting the pump to the degasser is as short as possible and locate the solvent reservoirs as close as possible to the pump. To avoid formation of air bubbles in the reservoirs and reformation of air bubbles in the solvent, make sure that the reservoirs are on the same level or higher as the pump. Therefore, stack the Solvent Rack onto the pump (→ Fig. 15).
- Before connecting the solvent supply lines, make sure that the connectors are free of contaminants. Even minute particles can allow air to enter the degasser, and thus reduce the degassing effectiveness.
- Normal phase eluents usually show only a low concentration of dissolved gases. Therefore, it is normally not required to use a degasser with these eluents.

4.3.2 Connecting the Solvent Reservoirs

The steps depend on the pump type.

- *All pumps except ISO-3100BM and HPG-3200BX:*
Follow the steps in section 4.3.2.1.
- *ISO-3100BM and HPG-3200BX:*
Follow the steps on page 61.

4.3.2.1 All Pumps Except ISO-3100BM and HPG-3200BX

i **Tip:** Solvent supply lines are provided in the accessories kits for the SRD-3x00 Solvent Racks. For UltiMate 3000XRS systems with an OAS-3x00TXRS Open Autosampler, the solvent supply lines are provided in the accessories kit for the autosampler.

1. Feed the solvent supply line through the retaining guide, which holds the tubing in place in the reservoir. Then, feed it into the open hole in the reservoir cap.
2. Slide the filter holder with filter frit onto the end of the solvent supply line.
3. If required
Cut the tubing straight if necessary. The end of the solvent supply line should be cut straight and not deformed. Use only the original solvent supply lines.
4. Place the entire unit in the reservoir.
5. Tighten the reservoir cap hand-tight. Press the retaining guide into the hole in the reservoir cap to hold the solvent supply line in place inside the reservoir.

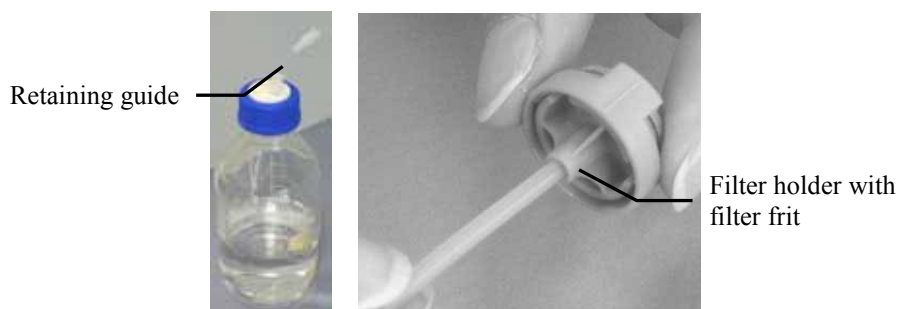

Fig. 16: Connecting the solvent supply lines to the reservoirs

When replacing a solvent supply line, remove the filter holder, then the retaining guide, and then the solvent supply line.

6. The solvent lines are connected to the pump at the factory.

◆ *All pumps except LPG-3400*

Connect the solvent supply lines from the reservoirs and from the pump to the degassing module of an appropriate SRD-3x00 Solvent Rack. For information about how to connect the tubing to the degasser, see the *Solvent Rack manual*.

◆ *LPG-3400*

Connect the solvent lines from the reservoirs and from the pump to the degassing module of the inbuilt vacuum degasser.

If a degasser is connected to the pump but is not used (degasser turned off), change the flow path and connect the solvent reservoirs directly to the pump, instead.

7. *Recommendation*

For the secure and functional positioning of the solvent reservoirs, place them in the tray of the Solvent Rack.

8. *ISO-3100SD, HPG-3200SD, HPG-3200RS*

For these pumps, keep the following in mind:

When the fluid components of the pump are filled with liquid and the solvent reservoirs are located above the pump outlet during pump operation, the hydrostatic pressure in the system may cause eluent to escape when you open a fluid connection in the pump. *Before* you open a fluid connection, position the reservoirs below the connection to be opened.

4.3.2.2 ISO-3100BM and HPG-3200BX

The solvent lines are connected to the pump at the factory.

1. Connect the free end of the tubing with the solvent reservoir as described in section 4.3.2.1 (→ page 60).

2. *Recommendation*

For the secure and functional positioning of the solvent reservoirs, place them in the tray of the Solvent Rack.

3. Keep the following in mind:

◆ When the fluid components of the pump are filled with liquid and the solvent reservoirs are located above the pump outlet during pump operation, the hydrostatic pressure in the system may cause eluent to escape when you open a fluid connection in the pump. *Before* you open a fluid connection, position the reservoirs below the connection to be opened.

◆ *HPG-3200BX*

To prevent the solvent from flowing through the pump fluidics when the pump flow is zero, close the shut off valve on the solvent supply line when the pump is not delivering.

4.4 Connecting Drain Tubing

To discharge liquids that might have accumulated in the interior and the seal wash solution, the pump has a drain port at the bottom right of the instrument.



Fig. 17: Drain port

Direct liquid leaks to waste through the drain system of the UltiMate 3000 system. The required components are shipped with the pump, but can be ordered also separately. The drain kit (part no. 6040.0005) includes all components for system drainage and detailed installation instructions.

Verify that the seal wash solution is discharged properly to the waste.

1. Remove the securing clip for the detector toward you, and then remove the detector toward to top.

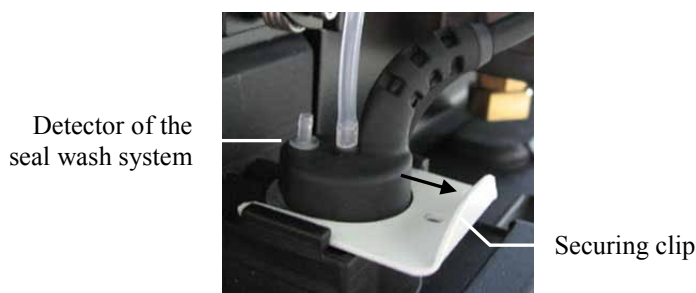

Fig. 18: Detector of the seal wash system

2. Fill the connection port of the seal wash system *several times* with HPLC grade water (→ Fig. 19) until the liquid exits the drain port at the bottom right of the pump.



Fig. 19: Filling water into the connection port

3. Verify that the liquid is discharged properly. If it is not, any modules that are located below the pump in the UltiMate 3000 system stack may suffer severe damage from the liquid leaving the drain port.

4.5 Setting Up the Rear Seal Wash System

The peristaltic pump is installed at the top left in the pump enclosure. The tubing under the peristaltic pump lever remains compressed and does not relax, thus blocking the wash solution. This can happen if the pump is not running for a longer period, for example, during shipment. That is why the pump is shipped with the active rear seal wash tubing *bypassing* the peristaltic pump.

1. Verify that the peristaltic tubing (white PharMed tubing) is engaged in the peristaltic pump.

If the tubing is not yet engaged in the peristaltic pump, press the lever to the left, place the tubing in the pump, and release the lever.

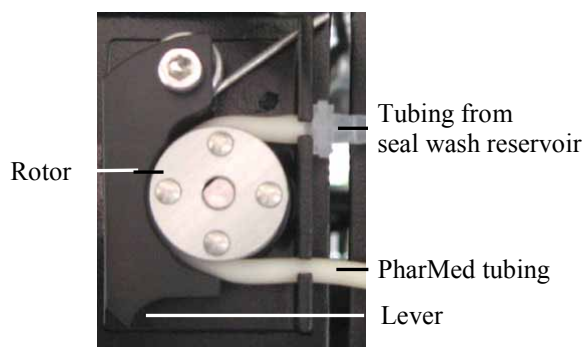

Fig. 20: Peristaltic pump

2. Fill the seal wash reservoir (a reservoir is provided in the accessories kit of the pump). Observe the precautions for the composition of the seal wash solution on page 95.
3. Connect the silicone tubing from the peristaltic pump with the seal wash reservoir. If necessary, prolong the tubing, for example, by using part of the silicone tubing from the pump accessories kit.
4. Place the seal wash reservoir in the Solvent Rack of the UltiMate 3000 system.
5. The seal wash solution is routed to the drain port at the bottom right of the pump. Verify that drain tubing is connected to the port and routed to an appropriate waste container (→ section 4.4, page 62).
6. Flush the system with seal wash solution.
 - a) Remove the seal wash tubing from the detector.

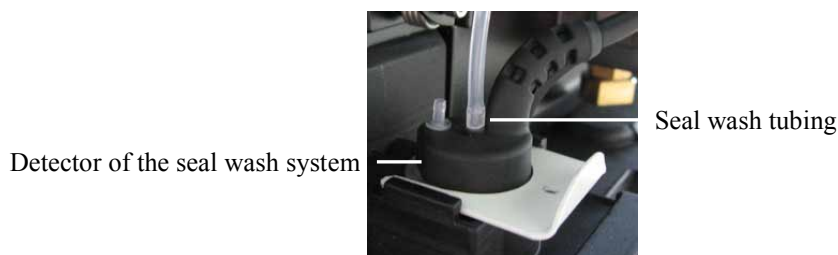

Fig. 21: Tubing connection on the seal wash detector

b) Draw seal wash solution into a syringe at the open end of the tubing. Press the lever of the peristaltic pump to the left so that the liquid can easily pass the system.

c) Reconnect the tubing to the detector.

Connect the tubing to the *inner* port (→ Fig. 21, page 63). The *outer* port has no function.

7. Verify that the seal wash solution is discharged properly to the waste (→ section 4.4).

For information about how to operate the pump with rear seal washing and for details about what happens, see section 5.5.6 (→ page 94).

4.6 Purging the Pump

Purging the pump means rinsing the system for a short time at a higher flow rate. Select one of the following alternatives:

- Purge the pump manually (→ page 66).
- If the UltiMate 3000 system includes a WPS-3000RS or WPS-3000SL autosampler, you can purge the pump also by means of the autosampler (→ page 68).

After the purge cycle has been initiated, the pump is purged with the following settings:

Pump Type	Purge Flow	Purge Time
Analytical pump	3 mL/min	5 min
Micro pump	2 mL/min	5 min
Semipreparative pump	30 mL/min	5 min

If necessary, you may change these standard settings in Chromeleon in the **Commands** dialog box or on the control panel for the pump or on the pump display on the **Preferences** menu (→ page 86).

Observe the following for the different pump types:

- *DGP-3600*
The two pumps of a DGP-3600 must be purged separately.
- *ISO-3100 and HPG-3200*
When the fluid components of the pump are filled with liquid and the solvent reservoirs are located above the pump outlet during pump operation, the hydrostatic pressure in the system may cause eluent to escape when you open a fluid connection in the pump. *Before* you open a fluid connection, position the reservoirs below the connection to be opened.
- *ISO-3100BM*
Also observe the information on page 101.

4.6.1 Purging the Pump Manually

1. Attach a piece of silicone tubing to the outlet nozzle on the purge unit. (Silicone tubing is provided in the accessory kit of the pump.)



Fig. 22: Purge valve on the purge unit

2. Attach the free end of the tube to a plastic syringe. A syringe is provided in the accessory kit of the pump.
3. Open the purge valve (turn the valve knob counterclockwise). If you are operating an ISO-3100BM, observe the precautions on page 101.
4. To be able to generate negative pressure, an autosampler or another type of pressure drop needs to be connected to the pump outlet. If necessary, cap the pump outlet.
5. Purge the pump from Chromeleon or from the pump display.

To purge the pump from Chromeleon

- a) In Chromeleon, open the **Commands** dialog box for the pump.
- b) Set the channel to be purged to 100%.
In Chromeleon, you cannot set %A directly. Thus, if %A be 100%, you have to set all other components of the eluent to 0%.
- c) Start the purge cycle. To do so, set **Purge** to **On**.
The purge cycle is performed with the selected settings (→ page 65).
- d) When the specified **PurgeTime** has elapsed, **Purge** is automatically reset to **Off**. You can stop purging also manually by setting **Purge** to **Off** yourself.
- e) Repeat the above steps for *all* channels (even if they are not used for the application) until all air bubbles are gone.

To purge the pump from the pump display

- a) Select the **Control** menu.
- b) Set the channel to be purged, for example **%A**, to 100%.
- c) Start the purge cycle. To do so, set **Purge** to **On**.
The purge cycle is performed with the selected settings (→ page 65).

- d) Draw the liquid with the syringe.
 - e) When the specified **PurgeTime** has elapsed, **Purge** is automatically reset to **Off**. You can stop purging also manually by setting **Purge** to **Off** yourself.
 - f) Repeat the above steps for all channels of the pump (even if they are not used for the application) until all air bubbles are gone.
- i** **Tip:** With some pump types, you can start the purge cycle also by selecting **Purge** on the navigation bar.
6. Close the purge valve. Turn the valve knob only with your hand (use no tools). If the valve knob leaks, tighten a little more. Overtightening the purge valve can damage the cap seal.

4.6.2 Purging the Pump by Using the Autosampler²

If the UltiMate 3000 system includes a WPS-3000RS or WPS-3000SL autosampler, you can purge the pump also from Chromeleon via the membrane pump of the autosampler to remove small amounts of air, for example, after exchanging the solvent. For an optimum performance, the purge flow should be as high as possible.

Pump Type	Recommended Flow Rate
Analytical pump	3 mL/min
Micro pump	2 mL/min
Semipreparative pump	30 mL/min

In addition, the static mixer or inline filter, depending on the pump type, should be permeable. Check the permeability (→ page 166 for the static mixer or page 170 for the inline filter).

1. Open the Properties dialog for the pump in the Chromeleon Server Configuration program (→ page 51).
2. On the **Devices** page, check the entry in the **WPS Purge Port** box to find out whether and with which autosampler the pump is fluidically connected (→ page 46).
3. In Chromeleon, open the **Commands** dialog box for the pump (→ page 75). Check and change the PurgeViaSampler setting if necessary.

Property	Setting
PurgeViaSampler	Select Yes to purge the pump by using the autosampler when Purge = On .

The property is listed under **PumpModule > [Pump Device Name]** (→ page 45).

4. Start the purge cycle. To do so, set **Purge** to **On**.

This is what happens: The autosampler needle descends into the wash port, and the solvent is drawn and directed to the waste through the membrane pump of the autosampler. The purge cycle is performed with the time and flow rate settings made under **PurgeTime** and **PurgeFlow** (→ page 65).

When the specified **PurgeTime** has elapsed, **Purge** is automatically reset to Off. You can stop purging also manually by setting **Purge** to **Off**.

² For patent reasons, this function must not be used in the following countries: China, Germany, Great Britain, Japan, and the USA.

4.7 Equilibrating the System

Before using the pump for sample analysis, equilibrate the UltiMate 3000 system:

1. Pump the starting solvent through the entire system until the system is free of any other liquid composition.
2. Heat or cool all temperature-controlled devices to the temperature required for the application.
3. Set the detector wavelengths and turn on the lamps.
4. Monitor the pump pressure. Verify that the reading is correct for the application and is stable. The compression value should remain stable under 100%. The compression value is displayed, for example, on the **Diagnostics** menu on the pump display (→ page 86).
5. Monitor the detector signal and verify that the baseline signal is at the expected reading for your application and is stable.

Perform system equilibration in Chromeleon or select the required commands and parameters on the front panel menus of the instruments.

To equilibrate the system from Chromeleon

- Select and perform the operating commands and parameters from the **Commands** dialog box.
- Create and run an equilibration program to automate the process (→ page 78).
- Use the SmartStartup Wizard to create and run the equilibration program (see further down in this section).

To create the equilibration program with the SmartStartup Wizard

1. To open the wizard, select **SmartStartup** on the **Batch** menu.
2. Follow the instructions as they appear on each page of the wizard. For additional information about a page, click **Help**.
3. After you finish the wizard, Chromeleon
 - ◆ Generates an equilibration program and sequence.
 - ◆ Opens the equilibration control panel for the instruments in the timebase (→ Fig. 23, page 70).
 - ◆ Opens the **Start Batch on** dialog box.

Click **Start** to begin equilibration.

The equilibration panel shows the equilibration status of each instrument in the system.

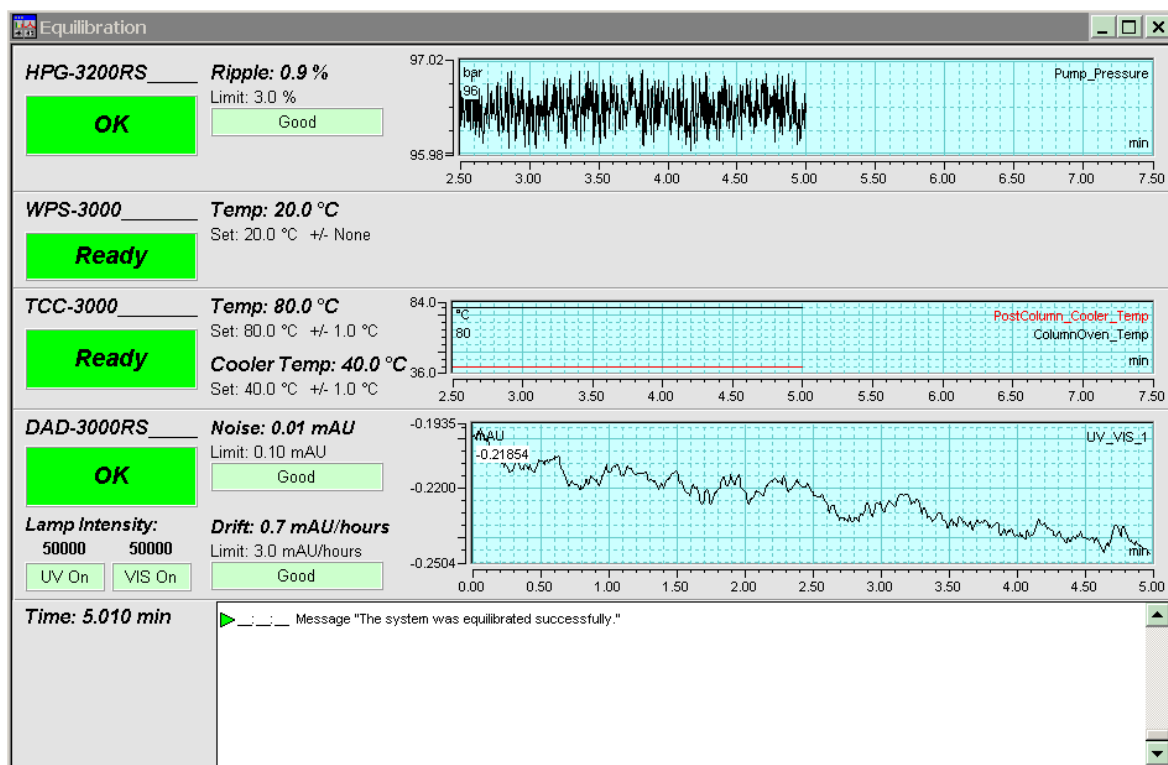

Fig. 23: Equilibration panel

To equilibrate the system from the front panel menus

Select and perform the operating commands and parameters on the front panel menus of the instruments. For information about the pump menus, see section 5.4.2 (→ page 82). For information about the menus of other system modules, see the *Operating Instructions* for the respective module.

5 Operation and Maintenance

The pump is operated with the Chromeleon Chromatography Management System. For details, see section 5.3 (→ page 74).

In addition, function keys and menus are available on the pump display to facilitate operation during, for example, initial installation, diagnostics, and maintenance. For example, you can:

- Perform certain commands (purge the pump, start and stop the flow)
- Set parameters (leak sensor mode, brightness, and contrast of the screen display)
- View and change the device configuration

For details, see section 5.4 (→ page 80).

5.1 Power-Up

To start the pump for the first time, turn on the main power switch on the rear panel of the pump. The following sequence of events occurs when the pump is powered up:

- For a short time, general information about the pump appears on the pump display: device type, serial number, and bootloader and firmware versions.
- The pump runs a series of internal tests. During these self-diagnostics, all of the main components are checked. When the self test was successful, the initial screen changes to the status screen (→ page 72).
- If an error is detected, the pump is not ready for analysis. The **Status** LED on the front panel door changes to red and a message appears on the pump display. If the pump is operated from Chromeleon, the message is also displayed in the Chromeleon Audit Trail. Turn off the pump, take appropriate remedial action (→ page 115), and turn on the pump again.

For routine operation of the pump, leave the main power switch on. For routine on/off control, use the standby button on the front of the pump (→ page 16). Press and hold the button for one second to allow the pump to change the mode. Turn the main power switch off when instructed to do so, for example, before performing a service procedure.

5.2 Status Screen

When the self test was successful, the initial screen changes to the status screen. The pump type determines the appearance of the screen:

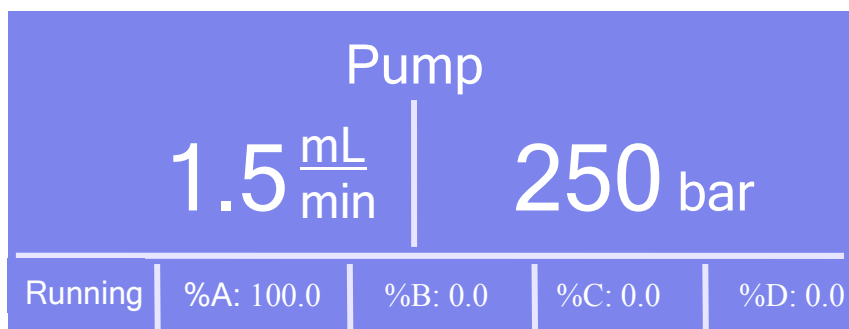

Fig. 24: Status screen (example)

The status screen shows the following information:

- Pump name
The pump name is the name specified under **Pump Device Name** on the **Devices** page in Chromeleon Server Configuration program (→ page 44). For a DGP-3600, the names are specified in the **Left Pump Device Name** and **Right Pump Device Name** boxes. On the pump display, you can then select on the Control menu for which pump of the DGP-3600 the values are displayed (→ page 85).
- Flow
- Pressure
- Components of the solvent in percent of the total flow

In addition, the following information may appear on the screen:

The screen shows ...	When ...
Running or Flow on	the pump is delivering with the specified flow rate. The display always shows the flow rate that the pump is actually delivering. When a flow ramp has been set in Chromeleon, it may take some time until the specified target flow is reached.
Off or Flow off	the pump is not delivering. While is pump is idle, the nominal flow rate is displayed and the flow value is flashing.
Purge	the pump is purged. While purging is running, the remaining purge time is displayed.

The screen shows ...	When ...
Hold	you performed the Hold command for the pump from Chromeleon. The retention time is stopped; however, the pump continues delivering with the current settings (flow rate, solvent composition). Perform the Continue command in Chromeleon to cancel the Hold command. For more information, see the <i>Chromeleon Help</i> .
Stopped	you performed the StopFlow command for the pump from Chromeleon. The retention time and the pump flow are stopped. Perform the Continue command in Chromeleon to cancel the StopFlow command. For more information, see the <i>Chromeleon Help</i> .

You can adapt the screen brightness and contrast to your requirements if necessary (→ page 97).

5.3 Operation from Chromeleon

Before you begin, verify that

1. The Chromeleon software is installed on the computer and the license code is entered.
2. The pump is connected to the Chromeleon computer by means of an USB connection.
3. The pump is set up in Chromeleon (→ page 40).

Before you can operate the pump from Chromeleon, you have to connect the timebase in which the pump is installed to the Chromeleon client program (→ section 5.3.1).

Two modes of software control are available:

- *Direct control* with the parameters and commands in the Commands dialog box (→ page 75) or on a control panel (→ page 77).
- *Automated control* with a control program (PGM) (→ page 78).

5.3.1 Connecting to Chromeleon

1. Start the Chromeleon Server Monitor and the Chromeleon server if they are not yet running (→ page 40).
2. Start the Chromeleon client by clicking the Chromeleon icon  on the desktop. If the Chromeleon icon is not on the desktop, click **Start** on the taskbar, point to **Programs** (or **All Programs**, depending on the operating system), point to **Chromeleon**, and then click **Chromeleon**.
3. Connect the Chromeleon client program to the timebase in which the pump is installed. For details about how to do this from the **Commands** dialog box, see page 75. For details about how to do this on a control panel, see page 77

When the pump is correctly connected to Chromeleon:

- The Connected LED on the front panel is green.
- Front panel input is disabled.
- Functions for estimating the lifetime of consumables and monitoring and recording service and (re)qualification information are provided (→ page 103).
- The Standby button on the front panel remains active.

Before turning off the pump by the main power switch, always disconnect the pump in Chromeleon.

5.3.2 Direct Control

With direct control, you select operating parameters and commands in the Commands (F8) dialog box. Direct commands are executed as soon as they are entered. For routine operation, most parameters and commands are available also on a control panel.

To open the Commands dialog box for the pump

1. Open a control panel (any panel is possible). To open a control panel, open the Chromeleon Browser and double-click a control panel in the Dionex Templates/Panels folder.
2. Connect the control panel to the timebase in which the pump is installed. On the **Control** menu, select **Connect to Timebase**, and then select the timebase on the **Timebase** tab. For information about the Timebase dialog, click Help.



Tip: The **Control** menu is visible only when a control panel is already open.

3. Press the F8 key or select **Command** on the **Control** menu.
4. To see the parameters and commands that are available for the pump, click the plus sign next to **PumpModule**. Here you see
 - ◆ General pump properties and commands, such as, Connect, Connected, Disconnected, LeakSensorMode, and Degasser.
 - ◆ Specific groups of properties and commands (listed under the **Pump Device** name specified during the configuration of the pump (→ page 45)), for example, the flow-related properties and commands.

The commands and parameters available in the dialog box vary, depending on the

- ◆ Chromeleon version
- ◆ Options selected for the pump in the Properties dialog (→ page 43).
- ◆ Display filter level (**Normal**, **Advanced**, or **Expert**)

5. Change the display filter level if necessary. Right-click in the commands list and select the filter level on the menu.

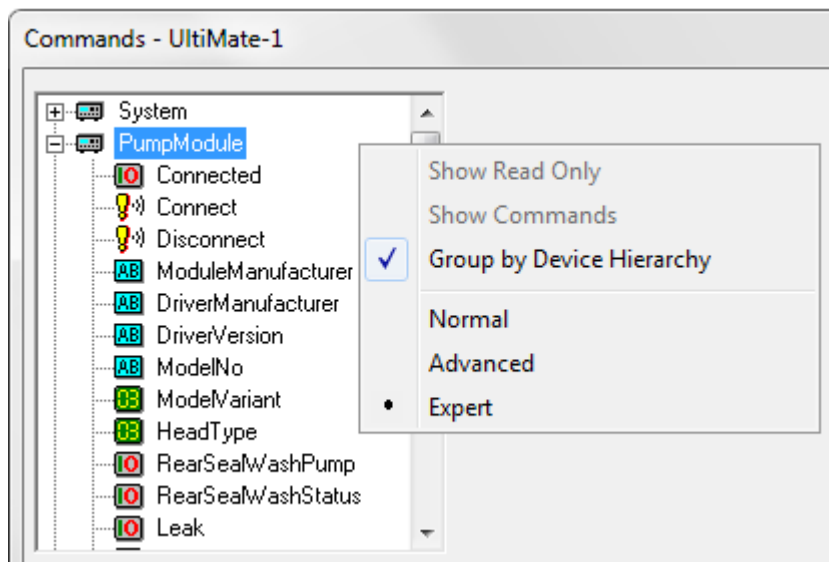

Fig. 25: Commands dialog box

6. Verify that the pump is connected to Chromeleon. If the pump is not yet connected, perform the **Connect** command.

For a list of the commands and properties that are supported for the pump, see the *Chromeleon Help*. In addition to the pump commands and parameters, the **Commands** dialog box provides access to all of the commands and parameters available for all devices that are installed in the selected timebase.

To open a control panel for the pump

1. On the **View** menu, click **Default Panel Tabset** or click the corresponding icon on the toolbar , and then connect to the Chromeleon server.

Chromeleon creates centralized control panels, called panel tabsets, for all timebases available on the Chromeleon server. A panel tabset provides control panels for the individual instruments in a timebase and, in addition, one or more panels for performing system-wide functions, for example, creating and running sequences. For more information about panel tabsets, see the *Chromeleon Help*.

2. On the Panel Tabset for your timebase, click the page for the pump.

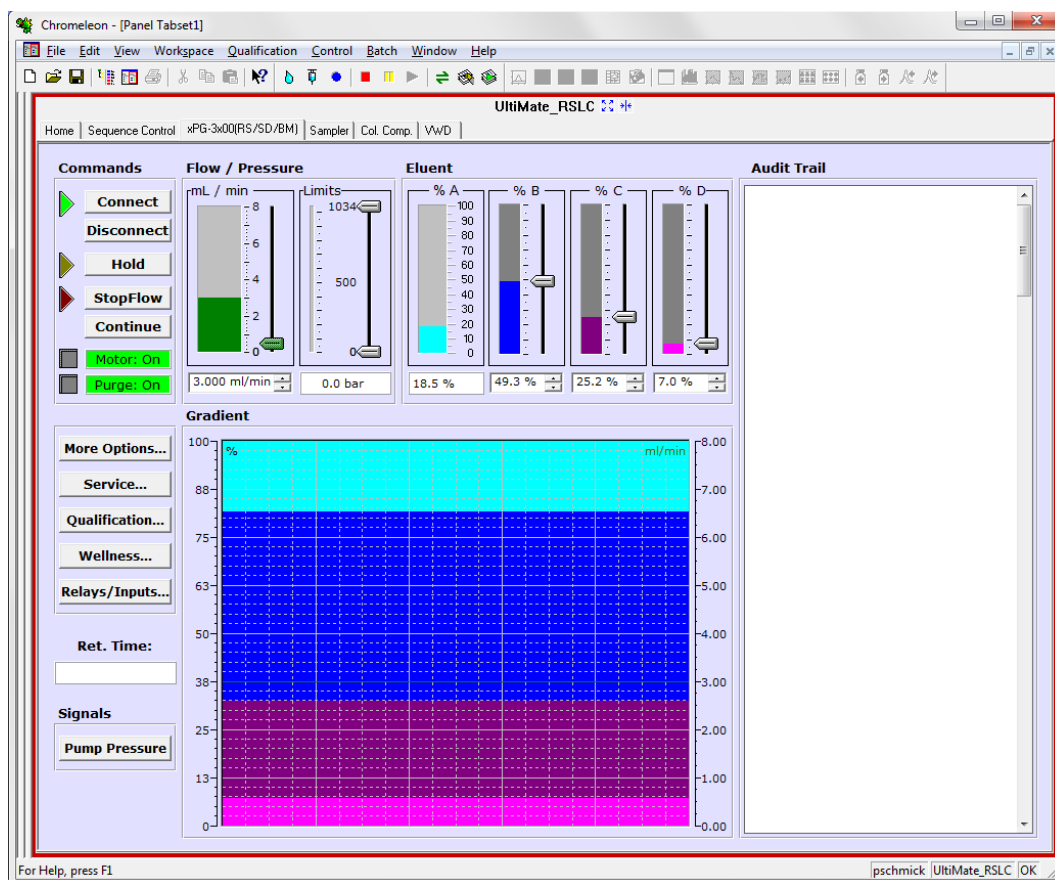

Fig. 26: Pump control panel

3. Verify that the pump is connected to Chromeleon (the LED next to the Connect button is green). If the pump is not yet connected, click **Connect**.

The control panel provides access to the operating parameters and commands required for routine operation of the pump. Additional functions are available in the Commands dialog box. To open the **Commands** box from the panel tabset, select **Command** on the **Control** menu.

5.3.3 Automated Control

With automated control, you create a program file (PGM) for automated operation of the pump. You can create programs automatically with the software wizard or manually by editing an existing program. In addition to programs for sample analysis, you can also create programs for special purposes, for example, to automate system shutdown (→ page 110) or to ensure that the system automatically restarts operation as desired after a power failure. For details, see the *Chromeleon Help*.

To create a program with the Program Wizard

1. Open the Program Wizard. On the **File** menu, select **New**, and then select **Program File**.
2. The wizard guides you through program creation. On each wizard page, accept or change the settings as appropriate. For additional information about a page, click **Help**.
3. After you finish the wizard, Chromeleon automatically creates the program.
4. To start the program, follow the steps on page 79.

To create a program manually

1. Open an existing program.

Select and double-click the program you want to open.

—or—

On the **File** menu, select **Open**. In the dialog box, select **Program** on the **Object of Type** list and select the program.

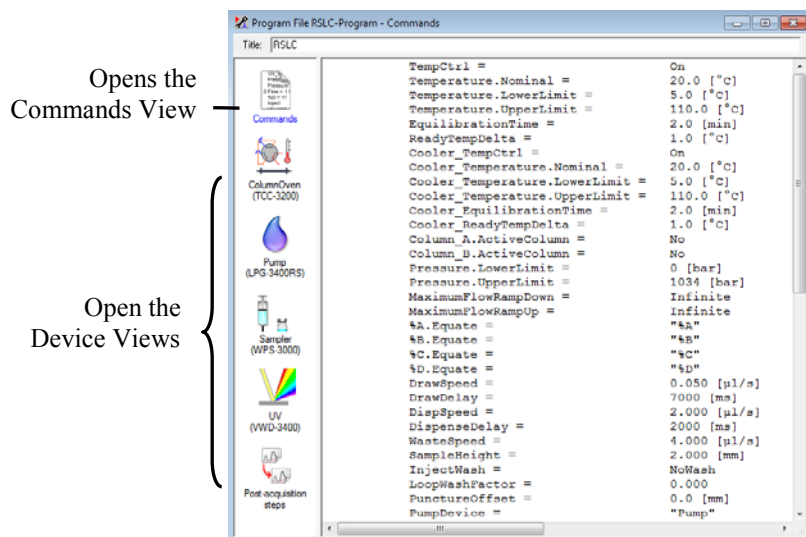

Fig. 27: Chromeleon program (here program shown in the Commands view)

2. Change the program settings as needed.

The easiest way to edit a program is to do this in the Device Views (→ Fig. 27). Click a device icon and change the settings on the device pages. Editing the program in the Device Views ensures correct command syntax.

If you cannot edit a certain parameter in the Device View, click **Commands** to open the Commands View. The **Commands** view shows the entire program, listing the control commands in chronological order. For more information, see the *Chromeleon Help*.

3. To start the program, follow the steps in the next section.

To start a program

Program for sample analysis

1. Create a sample list (sequence). A sequence must include the program and a method for evaluating the sample data (for example, for peak identification, area determination, and amount determination).
2. Assign the program and method to each sample on the list.
3. Add the sequence to the batch and start the batch.

For information about each of these steps, see the *Chromeleon Help*.

Other programs

Add the program to the batch and start the batch.

5.4 Function Keys and Menus on the Pump Display

Function keys and menus are available on the pump display. Thus, you can make several settings or execute certain commands directly from the pump.

- For information about the function keys, see section 5.4.1 and page 83.
- For information about the menus, see section 5.4.2 (→ page 82).

5.4.1 Showing the Function Keys

Four white spots on the front panel mark the positions of four function keys: **Menu**, **Flow on** (or **Flow off**), **Set flow**, and **Purge** (→ table further down in this section). To show the keys, touch the position of the utmost left spot on the pump display with the menu pen. The menu pen is included in the pump shipment.



Fig. 28: Showing the function keys

The function keys replace the information in the bottom line of the status screen. The pump type determines which function keys are available. When the pump is connected in Chromeleon, the function keys (except Menu) are not available.

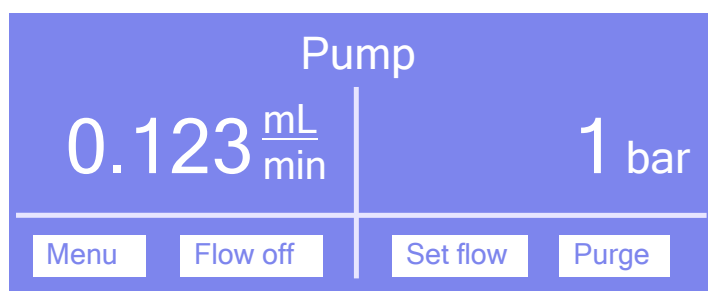

Fig. 29: Function keys

To ...	Select ...
Open the Main menu (→ page 84).	Menu
Have the pump deliver with the specified flow rate. While is pump is idle, the nominal flow rate is displayed and the flow value is flashing. Select Flow on to have the pump deliver with the displayed rate. While the pump is delivering with the displayed flow rate, the key name changes to Flow off, the real flow is displayed, and the flow value stops flashing. Select Flow off to have the pump stop delivering.	Flow on
Enter the pump flow.	Set flow
Purge the pump. The channel set on the Control menu is purged (→ page 85) with the Purge flow and Purge time values set on the Preferences menu (→ page 86). For more information about purging the pump, see section 4.6 (→ page 65).	Purge

If no key is selected, the bottom line of the status screen is restored after about 5 seconds.

5.4.2 Pump Menus

Fig. 30 shows an overview of the pump menus, here as an example for a DGP-3600RS. The pump type determines which menu items are available on the menus.

For information about the general menu layout and structure, see page 83. For information about the commands and parameters that are available on the menus, see sections 5.4.2.2 through 5.4.2.6 (→ page 84).

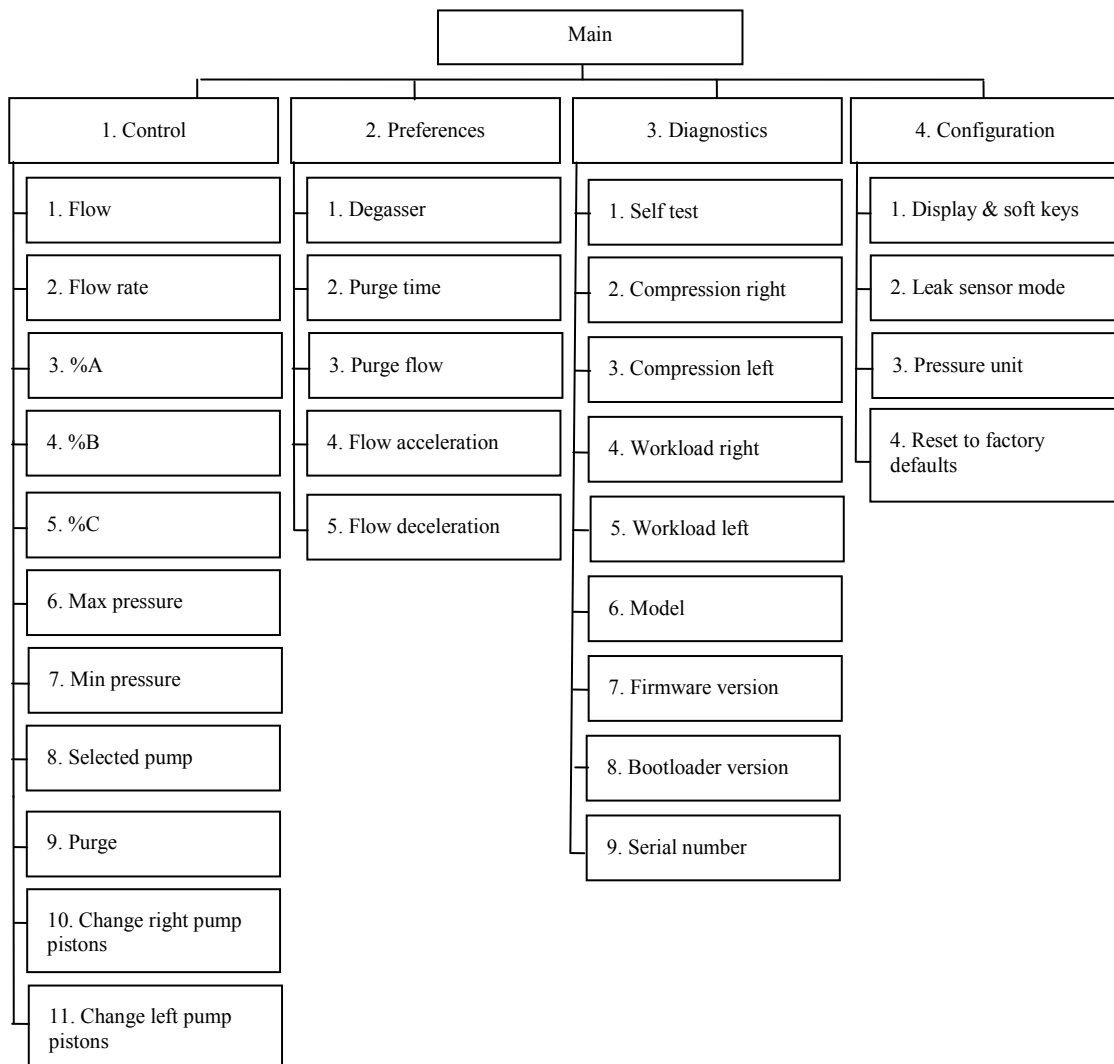

Fig. 30: Menu structure (here for a DGP-3600RS)

5.4.2.1 General Menu Layout and Structure

In general, the menu layout is as follows:

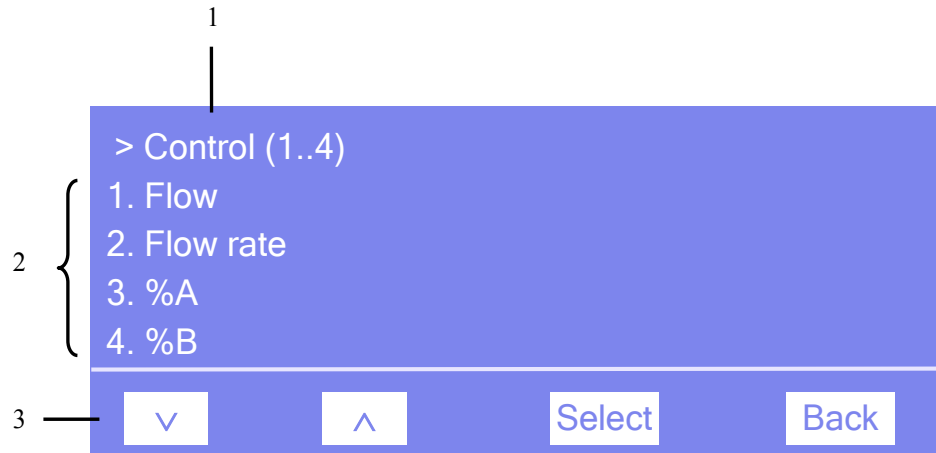

Fig. 31: Menu layout (here Control menu)

No.	Description
1	Reports the menu name and the number of items on the menu list.
2	The menu items appear on a list and are numbered consecutively. The selected item is underlined.
3	Navigation bar

Select an item with the arrow up or down key—the selected item is underlined. Confirm your selection with **Select**. **Back** returns you to the previous menu level.

The selected menu item or parameter determines which keys appear on the navigation bar:

To ...	Select ...
Return to the previous entry on a list. If the list contains 5 or more items, you can use the arrow up key to scroll up through the list, after reaching the first line (→ Key autorepeat , page 87).	^
Increment numerical values.	^
Proceed to the next entry on a list. If the list contains 5 or more items, you can use the arrow down key to scroll up through the list, after reaching the fourth line (→ Key autorepeat , page 87).	v
Proceed to the next figure in a number. Any decimal point is skipped.	>
Confirm the selection and activate the input field if applicable. If an item is read-only, the Select key will not be available.	Select
Return to the previous menu level.	Back
Toggle between two operating states (for example, between On and Off).	Toggle

To ...	Select ...
Confirm the selection or input.	OK
Cancel the action and restore the last value.	Cancel
Note: Depending on the selected option, specific keys may replace these general keys.	

If an error is found, one or more messages appear on the pump display. In this case, the **Prev**, **Next**, and **Clear** keys appear on the navigation bar.

To ...	Select ...
Return to the previous message.	Prev
Proceed to the next message.	Next
Remove a message from the display.	Clear

5.4.2.2 Main Menu

The **Main** menu provides top-level access to the menu structure. To open the Main menu, show the function keys and select **Menu** (→ page 80).

From the **Main** menu, you can open the following menus:

- **Control**
On the **Control** menu, you can make the different settings for pump operation (→ page 85).
- **Preferences**
On the **Preferences** menu, you can make the basic settings for the pump (→ page 86).
- **Diagnostics**
The **Diagnostics** menu provides information for diagnostic purposes (read-only). In addition, you can perform a self-test for the pump module (→ page 86)
- **Configuration**
The **Configuration** menu provides information about the pump configuration and allows you to make the required settings or perform the related commands (→ page 87).

The pump type determines which menus, commands, and parameters are available on the menus.

5.4.2.3 Control Menu

On the **Control** menu, you can make the different settings for pump operation.

To ...	Select ...
Start the pump flow with the selected flow rate or to stop the flow.	Flow
Set the flow rate.	Flow rate
Enter the related component of the solvent in percent of the total flow.	%A through D
Set the maximum pressure.	Max. pressure
Set the minimum pressure.	Min. pressure
Specify for a DGP-3600 for which pump the values are entered or displayed on the pump display.	Selected pump
Purge the pump. The selected channel is purged with the Purge flow and Purge time values from the Preferences menu (→ page 86). For more information about purging the pump, see section 4.6 (→ page 65).	Purge
Open the Pump/Maintenance dialog for piston and piston seal replacement. From this dialog box, you can undock the pistons for the replacement procedures and dock them later again. For more information, see section 7.5.2 (→ page 150).	<i>Depending on the pump type:</i> Change right pump pistons and/or Change left pump pistons —or— Change pump pistons

5.4.2.4 Preferences Menu

On the **Preferences** menu, you can make the basic settings for the pump.

To ...	Select ...
Turn the degasser of a LPG-3400 or SRD-3x00 Solvent Rack on or off.	Degasser
Set how long the pump is purged. The default purge time is 300 seconds.	Purge time
Set the flow rate for purging. The default purge flow is as follows: 3 mL/min for analytical pumps 2 mL/min for micro pumps 30 mL/min for the semipreparative pump	Purge flow
Set the upper value for the flow rate acceleration. For details, see page 92.	Flow acceleration
Set the upper value for the flow rate deceleration. For details, see page 92.	Flow deceleration

5.4.2.5 Diagnostics Menu

The **Diagnostics** menu provides information for diagnostic purposes (read-only). In addition, you can perform a self test.

To ...	Select ...
Perform a self test. If an error or mechanical fault is detected, the Status LED on the front panel door changes to red and a message appears on the pump display.	Self test
See the compression value of the last stroke for the related pump head. The value is indicated in per cent. For more information about the compression value, see page 134.	<i>Depending on the pump type:</i> Compression right and/or Compression left —or— Compression
See the workload of the related pump block since the pump has been operated for the first time. The workload is calculated from the flow rate, pressure, and time.	<i>Depending on the pump type:</i> Workload right and/or Workload left —or— Workload
See the pump model.	Model
See which firmware version is installed.	Firmware version
See the bootloader version.	Bootloader version
See the serial number of the pump.	Serial number

5.4.2.6 Configuration Menu

The **Configuration** menu provides information about the pump configuration and allows you to make the required settings or perform the related commands.

To ...	Select ...
Set the display and function key parameters: Brightness —sets the screen brightness. (The input is in percent.) Contrast —sets the screen contrast. (The input is in percent.) Key sound —sets whether a beep sounds when you select a function key. Key autorepeat —sets whether the keystroke is automatically repeated when you remain on the key for a longer period, for example, to change a value quickly.	Display & soft keys
Turn leak detection off if necessary and on again: Disabled —turns leak detection off. Enabled —turns leak detection on. Leak detection is enabled as a standard. For more information about how operate the pump with leak detection, see page 97.	Leak sensor mode
Set the pressure unit.	Pressure unit
Restore the factory settings. In the Reset to factory defaults? dialog box, select OK to confirm the restore the factory settings or select Cancel to keep your settings.	Reset to factory defaults

5.5 Information for Operating the Pump

This section provides specific information about settings and functions that should be considered for operating the pump.

To learn more about ...	See page ...
Choosing the solvents	See below.
Linking the pump to the autosampler	91
Setting the flow rate, flow acceleration, and flow deceleration	92
Setting the pressure limits	93
Recording the pump pressure	94
Rear seal wash system	94
Purging the pump	96
Detecting liquid leaks	97
Adjusting the screen brightness or contrast	97
SmartStartup and SmartShutdown	98
Notes on degasser operation (LPG-3400 and SRD-3x00)	99
Precautions for pump operation (ISO-3100BM)	101
Precautions for pump operation (HPG-3200BX)	102

Also observe the information about special functions in Chromeleon (→ page 103).

5.5.1 Choosing the Solvents

Observe the following precautions for solvent selection:

- Observe the precautionary statements in section 1.2.2 (→ page 4).
- The pump is primed with 2-propanol. During initial operation, make sure that the solvents used are miscible with 2-propanol. Otherwise, follow the appropriate intermediate steps.
- Use only HPLC grade or LC-MS grade water (0.2 µm, filtered).
If water from water purification systems is used that are not properly maintained, polymeric contamination may seriously damage the column, rapidly block the solvent frits, and result in early piston seal wear.
- Use only standard solvents and buffers that are compatible with all parts of the UltiMate 3000 system that may be exposed to solvents.
For information about the wetted parts in the pump, see the Technical Information section (→ page 207). For information about the wetted parts in the other UltiMate 3000

system modules, refer to the 'Technical Information' section in the operating instructions for the modules.

- Make sure to use special (highly pure) solvents. They are usually labeled accordingly by the vendor.
- Mind the special properties of the solvents, such as viscosity, boiling point, UV absorption (UV/VIS detector), refractive index (refractive index detector), and dissolved gas (degasser).
- pH range: 1 through 13
In rare cases, reactions with pump components have been observed for pH values \geq in combination with special solvents and longer application times. Therefore, you should flush the system thoroughly after these applications and monitor the system behavior. pH values > 12 may affect electrochemical detection. Therefore, disconnect the detector from the system fluidics before using highly alkaline solvents for flushing the system. For more information about the requirements for electrochemical detection, see the Operating Instructions for the electrochemical detector.
- Buffer concentration
SD pumps: Typically up to 1 mol/L (< 0.1 mol/L chloride ions).
RS, BM, and BX pumps: Typically up to 1 mol/L (≤ 1 mol/L chloride ions).
- Observe also the information about the pH range and buffer concentration in the Operating Instructions for the other UltiMate 3000 system modules.
- Except for the SDN pump, the pump is shipped with reversed phase (RP) seals as main piston seals.
Keep in mind that using chloroform, trichlorobenzene, methylene chloride, tetrahydrofuran, or toluene as solvents chemically damages the UHMW-PE seals. Chemical reactions may also occur when using tetrachloromethane, diethyl ether, diisopropyl ether, ketones, toluene, methylcyclohexane, and monochlorobenzene. If you use these solvents, contact the Thermo Fisher Scientific sales organization for Dionex HPLC Products.
- If the UltiMate 3000 system includes a LPG-3400 pump or a SRD-3x00 Solvent Rack, observe also the solvent compatibility of the degasser.
Whenever possible, avoid using the following solvents: hexafluoroisopropanol, solvents containing hydrofluoric acid, perfluorinated solvents, and freons. For modules with a serial number < 8014538 , you should avoid also hexanes (60% n-Hexane).

- In an UltiMate 3000 system, some components are made of PEEK. This polymer has superb chemical resistance to most organic solvents. However, it tends to swell when in contact with trichloromethane (CHCl₃), dimethyl sulfoxide (DMSO), or tetrahydrofuran (THF). In addition, it is attacked by concentrated acids, such as, sulfuric acid and nitric acid or a mixture of hexane, ethyl acetate, and methanol. In both cases, capillaries may start leaking or they can burst. Swelling or attack by concentrated acids is not a problem with brief flushing procedures. For more information about the chemical resistance of PEEK, see the table in section 12.1 (→ page 235).
- Before switching from buffer to organic solution, rinse the pump thoroughly with deionized water.
- When switching to another solvent, ensure that the new solvent is miscible with the one contained in the pump. Otherwise, the pump can be damaged; for example, by flocculation.
- When replacing solvents, make sure that the solvents are miscible. Mix immiscible solvents with an intermediate solvent (for example, isopropanol) to replace them step-by-step.
- After operation, rinse out buffers and solutions that form peroxides.

 **Important:** *Neither* recycle the solvent **nor** use methanol from aluminum reservoirs. This may impair the performance of the seals.

 **Important:** Thermo Fisher Scientific déconseille de recycler les solvants ou employer du méthanol stocké dans des réservoirs en aluminium. Ceci peut affecter les performances des joints.

5.5.2 Linking the Pump to the Autosampler

The autosampler determines which settings have to be made:

- *OAS-3x00TXRS*
Follow the steps in the *autosampler manual*.
- *WPS-3000 or ACC-3000 autosampler*
Follow the steps further down on this page.

UltiMate 3000 system with WPS-3000 or ACC-3000

Specify the pump with which the autosampler is to be linked. Thermo Fisher Scientific recommends always specifying a pump because this setting

- Indicates which pump delivers the flow. The information is important if you want to operate the system in bypass mode (possible only with WPS-3000SL and WPS-3000RS). For more information about the bypass mode, see the *autosampler manual* and the *Chromeleon Help*.
 - Allows synchronizing the injection command of the autosampler with the strokes of a low-pressure gradient pump. Synchronization ensures that all injections are performed at the same phase of the pump cycle, considerably enhancing the retention time precision with gradient applications.
1. Start the **Server Configuration** program (→ page 42).
 2. Right-click the autosampler in the timebase and click **Properties** on the menu.
 3. Click the **Segments / Pump Link** page and select the pump to which the autosampler is linked. Select the pump to which the autosampler is linked on the **Flow through sampler is delivered by pump(s)** list.
 - ◆ *If the UltiMate 3000 system includes a DGP-3600 pump*
Select **UM3PUMP_L_STRK** to link the autosampler to the left pump. To link the autosampler to the right pump, select **UM3PUMP_R_STRK**.
 - ◆ *If the UltiMate 3000 system includes a pump other than a DGP-3600*
Select **UM3PUMP_STROKE**.
 - ◆ *If you do not want to link the autosampler to a pump*
Select **<None>**.

The pump link setting on the **Segments / Pump Link** page is the standard setting. To change the setting for a specific application, use the **SyncWithPump** and **PumpDevice** properties in the **Commands** dialog box or in the program (PGM).

- To disable synchronization, set **SyncWithPump** to **Off**.
- To use a different pump, enter the pump under **PumpDevice**, and then verify that **SyncWithPump** is set to **On**.

The standard setting on the **Segments / Pump Link** page remains unchanged.

5.5.3 Setting the Flow Rate, Flow Acceleration, and Flow Deceleration

In Chromeleon or on the pump menus, you can set how fast the pump starts delivering with the selected flow rate (flow acceleration) and how fast the pump flow is reduced (flow deceleration).

- If the values are too low, it will take accordingly long for the pump to reach the necessary flow, and thus to build up the necessary pressure or reduce the flow and thus, the pressure as required.
- If the values are too high, this may or reduce the lifetime of the column.

Recommendation: Set these parameters to values between 1/3 and factor 3 of the (column) flow rate.

To set the flow rate, flow acceleration, and flow deceleration in Chromeleon

1. In Chromeleon, open the **Commands** dialog box for the pump (→ page 75).
2. Select **Flow** and enter the flow rate in the **Nominal** box.
The property is listed under **PumpModule > [Pump Device Name]** (→ page 45).
The allowed flow rate range is indicated in the Properties dialog for the pump (→ page 47). In the Properties dialog box, you can change the upper and lower limit for the flow rate within the allowed range.
3. Under **MaximumFlowRampUp**, check and change the flow acceleration setting if necessary.
Under **MaximumFlowRampDown**, check and change the flow deceleration setting if necessary.

To set the flow rate, flow acceleration, and flow deceleration on the display

1. Select the **Control** menu.
2. Select **Flow Rate** and enter the preferred value.
 **Tip:** You can enter the flow rate also by selecting **Set flow** on the navigation bar.
3. On the pump display, select the **Preferences** menu.
4. Under **Flow Acceleration**, check and change the flow acceleration setting if necessary.
Under **Flow Deceleration**, check and change the flow deceleration setting if necessary.

5.5.4 Setting the Pressure Limits

The pump firmware and Chromeleon provide standard values for the upper and lower pressure limits. The limits depend on the pump type. You are free to change the limits within the allowed pressure range.

If the pump pressure is outside the specified limits, the related message appears on the pump display. If the pump is operated from Chromeleon, the message is also displayed in the Chromeleon Audit Trail. In addition, Chromeleon stops the flow and aborts the batch. Check the Troubleshooting section for a short description of possible causes along with recommended courses of action (→ page 115).

- *Lower pressure limit*
Helps to prevent the pump, and thus the column, from running dry. A typical setting is 1 MPa.
- *Upper Pressure Limit*
Helps to protect the column from too high a pressure. The application and column type determine the setting.

To set the pressure limits in Chromeleon

A Pressure range

The range within which the pressure limits can be set and the pressure unit are specified in the Properties dialog for the pump (→ page 47). You can set the upper and lower pressure limits only within the specified range.

B To change the pressure limits for a specific application

1. Open the **Commands** dialog box for the pump (→ page 75).
2. Select **Pressure** and enter the new limits under **LowerLimit** and **UpperLimit**.
The property is listed under **PumpModule > [Pump Device Name]** (→ page 45).

To set the pressure limits on the front panel display

1. Select the **Control** menu.
2. Check and change the limits for **Max. pressure** and **Min. pressure** if necessary.

You can change the **Pressure unit** on the **Configuration** menu. When the pump is operated from Chromeleon, the pressure unit specified in Chromeleon will be used.

5.5.5 Recording the Pump Pressure

On the **Signals** page, the check box for the pump pressure is selected by default when the pump is installed and configured in Chromeleon (→ page 49). With this setting, Chromeleon generates the appropriate channel for recording the pump pressure. The channel is then available in the Commands dialog box for the pump.

The channel name is generated from the entry in the **Pump Device Name** box on the **Devices** page (→ page 45). The name is extended by **_Pressure**. The recorded pressure is the pressure in the purge unit, which, in all cases, should be the *column pressure*.

If a problem occurs, the pump pressure channel can provide helpful information to identify and eliminate the source for the problem. Therefore, always record the pump pressure.

5.5.6 Rear Seal Wash System

Rear seal washing helps avoiding damages to the pistons, piston seals, and support rings, and thus prolongs the seal lifetime. For information about how to connect the rear seal wash system, see page 63.

5.5.6.1 Working with Rear Seal Washing

The rear seal wash system is enabled and cannot be disabled. As a standard, one seal washing cycle is performed per hour. However, you can start an additional wash cycle or stop a running cycle.

1. Open the **Commands** dialog box for the pump.
2. Select **RearSealWashPump**. If **RearSealWashPump** =
 - ◆ **Idle**, select **Active** to start a wash cycle.
 - ◆ **Active**, select **Idle** to stop the running wash cycle.

Observe the following:

- Always use fresh rear seal wash solution.
- Observe the precautions for the composition of the seal wash solution (→ page 95).
- There will be a warning when the reservoir is empty ("Rear seal wash system has run out of wash solution"). Nevertheless, check the liquid level in the seal wash reservoir at regular intervals.
- Regularly check the volume in the waste container for the seal wash solution. Empty the container as necessary.

5.5.6.2 Choosing the Seal Wash Solution

Observe the precautions for the composition of the seal wash solution:

- Make sure that the liquid used for rear seal washing is miscible with the solvent. This is to avoid impairing the tightness of the pump.
- Make sure that the seal wash solution is compatible with the silicone tubing.
- For reliable detector performance, the seal wash solution must have certain conductivity. For RP applications, standard HPLC grade water with 10% methanol is appropriate. (Isopropanol should not be used as an additive.)

NP applications

For NP applications, isopropanol with 0.1% sulfuric acid (to ensure that the liquid is conductive) is recommended. In addition, replace the silicone tubing and the detector of the rear seal wash system with the PharMed tubing and the NP detector from the appropriate Normal Phase (NP) kit (SD(N) pumps, part no. 6040.1972; HPG-3200BX, part no. 6040.1975). Replacing these components is required also for running NP applications with SDN pumps.

- If you have to use a liquid other than HPLC grade water due to the miscibility of the delivered solvent, you have to make the liquid slightly conductive by using the appropriate additives. Do not use additives with a high salt content or additives that cause solid residuals upon evaporation. Be sure that with this liquid drops are present in the detector.

5.5.6.3 What happens

Correct functioning of the rear seal wash system

During the delivery period of the peristaltic pump, liquid reaches the detector of the rear seal wash system. This means that the seal wash system performs correctly. The tubing is all right and the peristaltic pump works correctly.

Malfunctioning of the rear seal wash system

If no drops reach the detector after maximum five minutes although the peristaltic pump is pumping, this may indicate that the

- Seal wash reservoir is empty.
- Peristaltic tubing is blocked or crimped.
- The seal wash tubing (silicone tubing) is pinched.
- Detector of the system is dirty.

In all cases, the following message appears in the Chromeleon Audit Trail: "Rear seal wash system has run out of wash solution". If the rear seal liquid is not discharged properly to the waste, the following message may appear: "The rear seal leak sensor detects drops constantly".

Take the following remedial action:

- Check the seal wash reservoir level.
- Replace the peristaltic tubing.
- Verify that the liquid can pass the tubing properly. Replace the tubing if required.
- Clean the detector electrodes (→ page 140).

i **Tip:** If the seal wash reservoir is empty, the **RearSealWashDry** property in Chromeleon (Commands dialog box) reports **Dry**. To start a batch or set the pump flow nevertheless, set **OverrideRearSealDry** to **Enabled**. However, note that the property will be automatically reset to **Disabled** after each wash cycle.

Possible leakage of the main piston seal

If the message "Piston seal leakage has exceeded the recommended limit" appears, this indicates possible leakage of the piston seals.

Take the following remedial action:

- Inspect the piston seals for leakage (→ page 149).
- Replace the piston seals (→ page 155).

5.5.7 Purging the Pump

If you observe pressure pulsation, a high noise level, or pulsation during the operation of the pump or if the analysis is not reproducible, this may indicate that there are air bubbles in the system.

In this case, purge the pump as described in section 4.6 (→ page 65).

5.5.8 Detecting Liquid Leaks in the Pump

Leak detection is enabled as a standard when the pump is shipped. When leak detection is active and the leak sensor reports a leak

- The Status LED on the front panel door is red.
- A message appears in Chromeleon and on the pump display.
- The Leak property in Chromeleon is set to Leak.
- A beep alerts you.
- The pump stops the flow if the leak sensor reports a leak for at least 3 minutes.

When the leak sensor reports a leak,

- Locate the source for the leak, eliminate the cause, and dry the leak sensor (→ page 137).
- You can disable the alarm temporarily.

To do so, open the **Commands** dialog box for the pump and perform the **AlarmOff** command.

This also turns off the beep and allows you to restart the pump flow.

If the leak sensor does not report Leak = NoLeak within 30 minutes after you have restarted the flow, another leak alarm will be issued and the pump flow will be stopped again.

You may disable leak detection permanently. However, it is not recommended to do so. To do so, select one of the following alternatives:

- In Chromeleon, open the **Commands** dialog box for the pump and set **LeakSensorMode** to **Disabled**.
- On the pump display, select the **Configuration** menu (→ page 87) and set **Leak sensor mode** to **Disabled**.

5.5.9 Adjusting the Screen Brightness or Contrast

You can adjust the screen brightness or screen contrast to your requirements from Chromeleon or on the pump display. Select one of the following alternatives:

- In Chromeleon, open the **Commands** dialog box for the pump. Change the screen brightness under **Brightness** and/or the screen contrast under **Contrast**.
- On the pump display, select the **Configuration** menu (→ page 87) and select **Display & soft keys**. Change the screen brightness under **Brightness** and/or the screen contrast under **Contrast**.

5.5.10 SmartStartup and SmartShutdown

The **SmartStartup** wizard assists you in automating regular routine tasks (→ page 69). With SmartStartup, the different modules of the UltiMate 3000 system are turned on automatically and in a controlled manner. For example, SmartStartup can purge the pump of the HPLC system automatically, flush the column, and perform system equilibration. Important module parameters, such as the pressure pulsation of the pump, are monitored. When the modules operate within these limits, the sample sequence, which was set up before, can be started automatically. SmartStartup can be used at any time.

i **Tip:** If the UltiMate 3000 system includes an ISO-3100BM pump, observe the information for the **Maximum Equilibration Time** on page 101.

If you have to interrupt system operation, use the **SmartShutdown** wizard to create a program to set the HPLC system into standby mode or to automate shutdown of the system (→ page 110).

5.5.11 Vacuum Degasser (LPG-3400 and SRD-3x00)

5.5.11.1 General Notes for Degasser Operation

In normal operation, the degasser is quiet. Even if the vacuum pump is running, the operating noise is very low. With higher load, the operating noise may slightly increase. However, this does not impair the degassing performance.

In addition, observe the following to ensure optimum degassing performance:

- Fill *all* channels (even if they are not used for the application) with eluent. Degas *all* channels. This will reduce the speed of the vacuum pump and reduce the degasser noise.
- To avoid contamination of the degasser:
 - ◆ Use fresh the solvents at regular intervals.
 - ◆ Clean the solvent lines.
 - ◆ Rinse the degassing channels (→ page 175).
- Do not deliver in circles or recycle the eluent. This may impair the degassing performance.
- Before connecting the solvent supply lines, make sure that the connectors are free of contaminants. Even minute particles can allow air to enter the degasser, and thus reduce the degassing effectiveness.
- When replacing solvents, make sure that the solvents are miscible. Mix immiscible solvents with an intermediate solvent (for example, isopropanol) to replace them step-by-step.
- Thoroughly rinse the degasser with methanol or isopropanol after operation. The methanol or isopropanol do not need to be removed afterward.
- Longer periods of inactivity after using saliferous buffers may result in salt crystallization in the gas separation membrane, thereby impairing the degassing performance. Rinse the degasser thoroughly with de-ionized water followed by either methanol or isopropanol.
- Also, observe the information about the solvent compatibility of the degasser (→ page 89).

5.5.11.2 Turning the Degasser On and Off

You can turn the vacuum degasser in a LPG-3400 or in a SRD-3x00 Solvent Rack (→ page 24) that is connected to the pump on and off from either the pump display or Chromeleon.

To turn the degasser on and off from the pump display

Select the Preferences menu and set Degasser to **On** or **Off**.

To turn the degasser on and off from Chromeleon

1. In the **Server Configuration** program, open the Properties dialog for the pump (→ page 51).
2. On the **Devices** page, verify that the **Degasser Control** setting is correct, that is, **Internal** for a LPG-3400 or **External** if a SRD-3x00 Solvent Rack is connected to the pump (→ page 44).
3. Open the **Commands** dialog box for the pump and set **Degasser** to **On** or **Off**.
—or—
Open the Tabset Panel for the pump (→ page 77) and click **More Options**. Under **Degasser**, set **Mode** to **On** or **Off**.

When the degasser is operated in Chromeleon, monitoring of the degasser vacuum and leak detection is performed from the pump. The related commands and properties are available in the Commands dialog box for the pump:

Chromeleon Property	Description
DegasserVacuum	Reports whether the degasser has reached the operating vacuum.
SolventRackLeak	Reports whether the leak sensor in the SRD detected a leak.

Tips for operating the degasser

- Thermo Fisher Scientific recommends always leaving the degasser on while the pump is on.
- Turning off the pump to which a SRD-3x00 Solvent Rack is connected also turns off the solvent rack. The same applies to Standby mode.

5.5.12 General Precautions for Operating an ISO-3100BM

When operating an ISO-3100BM, observe the following:

- When the fluid components of the pump are filled with liquid and the solvent reservoirs are located above the pump outlet during pump operation, the hydrostatic pressure in the system may cause eluent to escape when you open a fluid connection in the pump. *Before* you open a fluid connection, position the reservoirs below the connection to be opened.
- Avoid sudden pressure drops at the pulse damper, for example, by opening the purge valve. Damages to the pulse damper may result.
- To prevent eluent from abruptly escaping any connections, open any capillary connections in the pump and on to the column *only* when the system pressure is almost down. Wait until the pressure is less than 1 MPa before opening a connection.
- If the pressure can be reduced only by opening the purge valve, turn the valve knob slowly counterclockwise to allow sufficient time (minimum 5 seconds) for the pressure to bleed to zero.
- If you create an equilibration program for your system by using the SmartStartup wizard (→ page 98) *and* if the pump is to delivery at very low flow rates, you may have to prolong the **Maximum Equilibration Time** of 45 minutes on the **SmartStartup Wizard: Equilibration Conditions for Timebase** page.
- When using the pump with an electrochemical (EC) Coulochem III detector
 - ◆ It is highly recommended that the system be configured to automatically turn off the EC cells when a pump or system error occurs (→ Coulochem III User Manual, section 2.7.7 Inputs).
 - ◆ Always turn off the EC cells first *before* shutting down the pump or performing maintenance tasks.

5.5.13 General Precautions for Operating an HPG-3200BX

When operating a HPG-3200BX, observe the following:

- Only use the solvent supply lines with an inner diameter of 3.0 mm (part no. 6042.2530) that are shipped with the pump.
- Only use the filter frits from the accessories kit of the pump.
- Do not prolong the solvent supply lines.
- Especially for applications with high flow rates, make sure that the solvent reservoirs are located near the pump. The reservoirs should be on the same level or higher. To avoid the formation of air bubbles in the reservoirs, they must not be located below the pump level.
- To prevent the solvent from flowing through the pump fluidics when the pump flow is zero, close the shut off valve on the solvent supply line when the pump is not delivering.
- Thermo Fisher Scientific recommends using a preparative degasser. An analytical degasser *cannot* be used with the pump. If required, degas the solvent, for example, in an ultrasonic bath.
- Chromeleon supports the **Double Flow** mode for the pump. In the **Server Configuration** program, on the Limits page of the Properties dialog for the pump, verify that the **Double Flow** check box is selected (→ page 47).

In Double Flow mode, the pump can deliver flow rates above the rate that is usually allowed. Both pump blocks are used for the delivery, thus doubling the maximum allowed flow rate to 100 mL/min. The Double Flow mode is available for each solvent combination and composition that the pump supports. The pump automatically calculates the flow rate maximum considering that none of the two pump blocks delivers more than 50 mL/min.

Example A:

Both pump blocks deliver 50 %. In this way, each pump block delivers 50 mL/min so that the pump reaches the flow rate maximum of 100 mL/min.

Example B:

Pump block A delivers 60% and block B delivers 40%. Block A then delivers 50 mL/min while block B delivers correspondingly less, that is, 33.333 mL/min. In this case, the total maximum flow rate is 83.333 mL/min.

For more information, refer to the *Chromeleon Help*.

5.6 Special Chromeleon Functions

This section provides a short overview of some special functions that Chromeleon supports for the pump.

To learn more about ...	See page ...
Predictive performance	See below.
Diagnostics tests	105
Setting a gradient curve	106
Liquid level monitoring for solvent reservoirs and waste container	106
Using the digital inputs and outputs	108
Operational Qualification and Performance Qualification	108

All of these functions are available in the Commands dialog box (unless otherwise noted). In addition, some functions are available also on the control panel for the pump. For additional information about a function, see the *Chromeleon Help*.

5.6.1 Predictive Performance

Predictive Performance provides various functions for estimating the lifetime of consumables and for monitoring and recording service and (re)qualification information.

Commands Dialog Box

Open the **Commands** dialog box for the pump and enter the limits for the predictive performance parameters. For a list of the commands and counters that are supported for the pump, see the *Chromeleon Help*.

To keep the predictive performance information up-to-date, perform the following commands (→ table).

After you have ...	Perform the following command ...
Replaced the valve cartridges	CheckValveServiceDone ¹
Replaced the static mixer, inline filter, or filter frit in the inline filter (depending on the pump type)	MixerFritChanged ²
Replaced a piston	PistonsChanged ¹
Replaced the main piston seal	SealChanged ¹
Replaced the peristaltic tubing	RearSealWashTubeChanged ³
Replaced the entire pump head assembly	CheckValveServiceDone ¹ , PistonsChanged ¹ , SealChanged ¹ , SupportRingChanged ¹

After you have ...	Perform the following command ...
Replaced a support ring	SupportRingChanged ¹
Serviced the instrument (for example, annual maintenance)	ServiceDone ³
Performed instrument qualification	QualificationDone ³

¹ Listed in the Commands dialog box under PumpModule > [Pump Device Name]_Wellness_LeftBlock and/or PumpModule > [Pump Device Name]_Wellness_RightBlock

² Listed in the Commands dialog box under PumpModule > [Pump Device Name]_Wellness

³ Listed in the Commands dialog box under PumpModule_Wellness

For information about the [Pump Device Name], see page 45.

These commands reset the counters and update the information when the action was performed.

Control Panel

On the control panel for the pump, click **Wellness**, **Qualification**, and **Service** to see the related predictive performance commands and parameters on separate panels. On these panels, you can enter the limits and reset the counters. In addition, wellness bars provide visual indicators of qualification and service periods. The color-coding of the wellness bars provides information about the status:

Color	Description
Green	OK.
Yellow	The value will soon reach the specified limit and/or the related component needs servicing or should be replaced soon.
Orange	(Only for monitoring Qualification properties.) The value has reached the specified limit. However, a Grace Period has been specified during which the pump may still be operated.
Red	The value has reached the specified limit or the specified grace period has expired; replacement of a component, servicing, or qualification of the pump is overdue. The pump can no longer be operated; besides, it is not possible to start a batch.

In addition, a message appears in the Chromeleon Audit Trail when a limit has been reached.

5.6.2 Pump Diagnostics

All pumps except HPG-3200BX

To perform the tests, the diagnostics toolkit (part no. 6040.3099) is required. The kit includes all materials required for performing the tests.

1. Verify that the signal for pump pressure is enabled (→ page 49). If it is not, pump diagnostics cannot be performed.
2. On the **Control** menu, select **Diagnostics**. The **Control** menu is visible only when a control panel is open.
3. The Diagnostics dialog box lists all tests that are available for the devices in the current timebase. Select a pump test. A wizard guides you through the test. For more information about a test, see the *Chromeleon Help*.

To check the ...	Run the ...
Pump system (especially the fitting connections) for leakage	General Leak Test*
Valves and seals for leakage. The test provides information about the source for the leak.	Detailed Leak Test*
Overall performance of the pump, that is the pressure pulsation and compressibility compensation	Performance Test
The permeability of the static mixer or inline filter	Mixer Frit Test
Degasser vacuum. You can run this test for both the internal degasser of a LPG-3400 pump and the degasser of a SRD-3x00 Solvent Rack.	Degasser Vacuum Test

- * Before running these tests, be sure that the StaticMixer property is set to the correct value. If it is not, the leak tests may not provide reliable results.
You have to set the property also for the inline filter (ISO-3100, BM pumps, and single-step mixing system). Therefore, verify (for example, in the Commands dialog box) that the property is set to the value indicated on the mixer (inline filter). For the inline filter in LPG-3400BM and DGP-3600BM pumps and in the single-step mixing system, select **InlineFilter_10µL** on the list. For the inline filter in the ISO-3100BM, select **150µL**.

If a test fails, check the Chromeleon Diagnostics Messages section for a short description of possible causes along with recommended courses of action (→ page 124).

5.6.3 Setting a Gradient Curve

For ramp gradients and multi-step gradients, you can specify linear or non-linear (curved) gradient profiles. The gradient profile (curve) is set in the program.

1. Create a program with the Program Wizard (→ page 78).
2. On the Pump Options page, select Ramp or Multi-Step Gradient on the Gradient Type list.
3. On the **Flow Gradient Pump Options** page, enter the preferred curve (1 through 9) in the **Curve** box.

Curve 5, which is the standard setting, is linear. Changes in composition of the delivered solvent over time are constant. Curves 1 through 4 are convex upward. Curves 6 through 9 are concave upward.

In addition, you can define step gradients directly in the gradient table (for example, step A and B). As a result, more than 11 different options are available to change the gradient.

For more information, see the *Chromeleon Help*.

5.6.4 Liquid Level Monitoring for Solvent Reservoirs and Waste Container

Chromeleon features functions for solvent consumption monitoring and for monitoring the liquid level in the waste container. The following properties are available, for example, in the **Commands** dialog box for the pump:

Solvent Reservoirs (X = A, B, C, or D)	Description
%X_Level Value LowerLimit	Enter the following information for the related component of the solvent: The volume at the beginning of the sequence. The lower limit. If the liquid level in the solvent reservoirs reaches the lower limit and - an emergency program is available in Chromeleon, the pump is stopped as defined in the program. - <i>no</i> emergency program is available in Chromeleon, the batch is aborted, the pump flow is stopped, and the related message appears.
%X_WarningLimit	Set the limit when you want to be informed about the liquid level in the solvent reservoir. The input is in percent and refers to the lower limit. A message appears when the liquid level is below the lower limit plus the warning limit (= %X_Level.LowerLimit + %X_WarningLimit).
%X_Remain Time	Reports the time left until the liquid level is expected to reach the lower limit. The time is calculated from the current flow rate and the volume entered for %X_Level.Value.

Solvent Reservoirs (X = A, B, C, or D)	Description
WasteLevel Value UpperLimit	Set the following: The liquid level in the waste container at the beginning of a sequence. The upper limit for the liquid level. If the liquid level in the waste container reaches the upper limit and - an emergency program is available in Chromeleon, the pump is stopped as defined in the program. - <i>no</i> emergency program is available in Chromeleon, the batch is aborted, the pump flow is stopped, and the related message appears.
WasteWarningLimit	Set the limit when you want to be informed about the liquid level in the waste container. The input is in percent and refers to the upper limit. The message appears when the liquid level is above the upper limit x warning limit\100 (= WasteLevel.UpperLimit x WasteWarningLimit/100).
WasteRemain Time	Reports the time left until the liquid level is expected to reach the upper limit. The time is calculated from the current flow rate and the calculated current liquid level.

For more information about the properties in the table and about emergency programs, see the *Chromeleon Help*.

Only DGP-3600

In the Properties dialog of the pump, on the **Bottles** page, the standard setting is that both pumps of the DGP-3600 are connected to the same solvent reservoirs and waste container (→ page 48).

With this setting, Chromeleon assigns the two eluent properties, **%A/B/C_RemainTime** and **%A/B/C_WarningLimit**, and the two waste properties, **WasteRemainTime** and **WasteWarningLimit**, the same values for each pump.

Clear the check boxes on the **Bottles** page if the two pumps are connected to different solvent reservoirs and/or waste containers. Chromeleon will then support the properties for both pumps separately.

5.6.5 Using the Digital Inputs and Outputs (Digital I/O)

Before you begin, verify that

- The device that you want to control is connected to the digital I/O port on the rear panel of the pump (→ page 38) by an appropriate signal cable (6-pin Mini-DIN).
- The relay outputs and digital inputs you want to use are selected in the Properties dialog for the pump (→ page 49).

When these conditions are fulfilled, the relay outputs and digital inputs are available in Chromeleon, for example, in the Commands dialog box for the pump, and can be programmed as required. For information about the functions of the connector pins and pin assignment, see page 243.

5.6.6 Operational Qualification and Performance Qualification

To check and document the performance of the HPLC system, perform Operational and Performance Qualification. All materials required for performing qualification and detailed instructions are available on request.

5.7 Shutting Down the Pump

Observe the following precautions before interrupting the operation or before shipping the pump:

- Rinse out any solvents if necessary. Fill the pump with methanol or a similar alcohol, such as 2-propanol or ethanol. If a buffer is used as a part of the mobile phase, flush the system with several volumes of methanol/water (50:50) before it is shut down. This will prevent salt buildup inside the unit.
- If pump operation is interrupted for more than 5 days, remove the PharMed tubing from the peristaltic pump. To remove the tubing, slightly press the lever to the left, remove the tubing, and release the lever. This will avoid that the tubing remains compressed and does not relax, thus blocking the wash solution.
- If operation is interrupted for more than one week, fill the pump with methanol or a similar alcohol, such as 2-propanol or ethanol. If the solvents in the pump are not miscible with water, use an appropriate intermediate solvent.
- Rinse out buffers or solvents that form peroxides.
- If the pump flow is interrupted for longer periods (> 1 hour), you have to turn off the lamps in any UV or RF detector connected to the device to prevent evaporation in the flow cell.
- When using an electrochemical (EC) detector with the pump, *always* turn off the potential to the EC cells *before* shutting off the pump flow to prevent damage to the cells.
- If you want to ship or move the pump to a new location, no liquid must remain in the waste line of the rear seal wash system. The waste line is routed on the pump bottom to the drain port. If necessary, lift and tilt the pump from the left side of the enclosure and wait until no more liquid leaves the waste line.
- Ship the pump only in the original shipping container and observe the packing instructions.

If the original shipping container is not available, appropriate shipping containers and packing material can be ordered from Thermo Fisher Scientific sales organization for Dionex HPLC products. The packing instructions are included in the "Installation and Qualification Documents for Chromatography Instruments" binder and are available on request.

Shipping the pump in anything other than the original packaging voids the warranty.

If you are running Chromeleon, you can set the pump and HPLC system into the standby mode or automate system shutdown.

Standby Program

A standby program sets the HPLC system into standby mode. The main program steps are:

- At the end of the program, the program automatically reduces the flow.
- The program reduces temperature of all temperature-controlled modules in the system.

From the standby mode, you can reactivate the application very quickly.

Shutdown Program

A shutdown program automates shutdown of the HPLC system. The main program steps are:

- At the end of the program, the program automatically reduces the flow.
- The program turns off certain system components and functions (for example, detector lamps, temperature control).

To create a standby or shutdown program

Select one of the following alternatives:

- Select and perform the operating commands and parameters from the **Commands** dialog box (→ page 75).
- Create and run a corresponding program to automate the process (→ page 78).
- Use the SmartShutdown Wizard to create and run the program (see below).

To create the program with the SmartShutdown wizard

1. To open the wizard, click **SmartShutdown** on the **Batch** menu.
2. Follow the instructions as they appear on each page of the wizard. For additional information about a page, click **Help**.
3. After you finish the wizard, Chromeleon
 - ◆ Creates the program and saves it in the timebase for which you create the program.
 - ◆ Opens the **Start Batch on** dialog box.

Select the program and click **Start** to run the program.

For more information about the SmartShutdown wizard, see the *Chromeleon Help*.

5.8 Routine and Preventive Maintenance

The pump is made of high-quality components and materials to minimize maintenance requirements. All surfaces are resistant to weak acids, alkali, and organic solvents. Nevertheless, immediately wipe up all liquids spilled onto the module surface, by using lint-free cloth or paper. If surfaces are exposed for longer periods, these liquids can cause damage.

- *Internal Maintenance*

Every six weeks, the pump automatically performs an internal maintenance procedure when you initiate a purge cycle. While internal maintenance is running, the purge valve must remain open. When internal maintenance is complete, the purge cycle starts automatically.

If no purge cycle is initiated after another 6 weeks, a message appears in the Chromeleon Audit Trail, reminding you to start a purge cycle.

- *Predictive Performance and Diagnostics*

Chromeleon supports functions for estimating the lifetime of consumables and diagnostic tests to check the performance of certain pump components (→ pages 103 and 105).

- *ISO-3100 and HPG-3200*

When the fluid components of the pump are filled with liquid and the solvent reservoirs are located above the pump outlet during pump operation, the hydrostatic pressure in the system may cause eluent to escape when you open a fluid connection in the pump. *Before* you open a fluid connection, position the reservoirs below the connection to be opened.

To ensure optimum performance and maximum uptime of the pump, perform the maintenance procedures listed in the table at regular intervals. The exact maintenance schedule depends on a number of factors.

Frequency	What you should do...
Daily	Before you start operating the pump, inspect the fluid lines for air bubbles and degas the solvent.
	Check the fluid lines for indications of leakage.
	Check the fluid connections for indications of salt deposits.
	If the eluent is pure water, replace the eluent in the reservoir on a daily basis.
	Check the liquid level in the seal wash reservoir.
Daily	Check the liquid level in the waste container for the drain liquid and seal wash solution. Empty the container as necessary.
	When using buffer solutions, flush the system thoroughly after use. Use a solvent that does not contain buffers or salts.

Frequency	What you should do...
Regularly	Fill the seal wash reservoir, by using fresh liquid. Observe the precautions for the composition of the seal wash solution on (→ page 95).
	Inspect the tubing for indications of damage, such as cracks, nicks, cuts, or blockage.
	When buffer solutions are used, inspect the pump for leakage at least once a month (→ page 149).
	Check the filter frits in the solvent supply line filters for permeability. Replace the filter frits in regular intervals. This is especially important with aqueous solvents. Aqueous solvents may contaminate the filters with algae and other microorganisms that deposit on the filter frits. Therefore, use fresh the solvents at regular intervals. Rinse the reservoirs thoroughly before filling them.
	Drain tubing is connected to the drain ports on the bottom right of the pump. Verify that the tubes are unclogged and routed below the drain ports. Empty the waste container as needed.
	Inspect the electrodes of the seal wash detector for contamination. Clean the detector electrodes as necessary (→ page 140).
	Depending on the pump type, check the permeability of the static mixer (→ page 166) or inline filter (→ page 170). This check is especially important when you use normal phase piston seals in SD pumps.
	To avoid contamination of the degasser, prepare fresh solvents, clean the solvent supply lines, and rinse the degassing channels at regular intervals (→ page 175).
Annually	<i>Recommended:</i> Have authorized Service personnel perform preventive maintenance once a year.

The following maintenance kits are available for the pumps:

Maintenance kit for:	Part No.
ISO-3100SD	6040.1950
ISO-3100BM	6042.1950
HPG-3x00SD	6040.1953
HPG-3x00RS	6040.1956A
HPG-3200BX (RP Kit)	6042.1953
HPG-3200BX (NP Kit)	6042.1954
LPG-3400SD	6040.1951
LPG-3400RS	6040.1954A
LPG-3400BM	6042.1951
DGP-3600SD	6040.1952
DGP-3600RS	6040.1955A
DGP-3600BM	6042.1952
For information about the kit content, see section 11.3 (→ page 224).	

6 Troubleshooting

6.1 Overview

The following features help you to identify and eliminate the source for problems that may occur during the operation of the pump or UltiMate 3000 system.

- **Status LEDs**

- ◆ The status LEDs (light emitting diodes) on the front panel provide a quick visual check of the operational status of the pump. They indicate whether the pump is turned on, connected in Chromeleon, and operating properly (→ page 21).
- ◆ The status LED that is located above each pump head on the interior front panel indicates the operational status of the pump block (→ page 116).

- **Messages**

If a fault or error is detected during the operation of the pump, a message appears on the pump display. Check the Messages on the Pump Display section for recommended courses of action (→ page 117). If the pump is operated from Chromeleon, a message is also displayed in the Chromeleon Audit Trail.

i **Tip:** For information about operating problems that might occur during the operation of the pump or an UltiMate 3000 system, see Operating Problems (→ page 126).

- **Diagnostics Tests**

If the pump is connected in Chromeleon, Chromeleon provides several diagnostic tests allowing you to check the performance of certain pump components (→ page 105). If a test fails, check the Chromeleon Diagnostics Messages section for a short description of possible causes along with recommended courses of action (→ page 124).

i **Tip:** You can test the pump for leakage even if the pump is *not* connected in Chromeleon (→ page 172).

If you are unable to eliminate a problem following the instructions given here, contact Thermo Fisher Scientific Service for Dionex HPLC Products.

6.2 Pump Block Status Indicator

The status LED above a pump head on the interior front panel indicates the operational status of the pump block:

LED	Operational Status
The LED is dark.	No flow
The LED is green.	The pump head is delivering.
The LED flashes green. <i>In normal operation</i>	In addition, the message 'Compression limit reached' appears in the Chromeleon Audit Trail. The compression value was 100% during each of the past three strokes. If the compression value is lower than 100% for several strokes afterward, the message 'Compression back to normal' will appear in the Audit Trail. For more information about the compression values, see section 6.6 (→ page 134).
<i>During pump maintenance</i>	The pistons are in the appropriate position for piston (seal) replacement.
The LED flashes red.	The pistons are not in the appropriate position for normal operation (for example, after piston (seal) replacement) or an error occurred during internal maintenance (→ page 111). In both cases, the following message appears on the pump display "Undock err., open purge valve". A similar message appears in the Chromeleon Audit Trail. To resolve the problem: 1. Open the purge valve. If you are operating an ISO-3100BM, observe the precautions on page 101. 2. Perform the Dock Pistons command. 3. Close the purge valve.

6.3 Messages on the Pump Display

Each time a fault or error occurs during the operation of the pump, the Status LED on the front panel door changes to red and a message appears on the pump display. In this case, the Prev, Next, and Clear keys appear on the navigation bar.

To ...	Select ...
Return to the previous message.	Prev
Proceed to the next message.	Next
Remove all messages from the display.	Clear

These keys are active also when the pump is connected in Chromeleon.

When the pump is operated from Chromeleon

- The error is also displayed in the Chromeleon Audit Trail. The Audit Trail may provide additional information.
- Messages on the front panel display can be removed also by performing the **ClearDisplayError** command in Chromeleon.

The table lists pump-related messages and suggests appropriate remedial actions. The component to which the message relates may appear in front of the message text. In addition to the messages listed in the table, other messages may appear. If you cannot eliminate the problem, note the exact wording of the message. Contact Thermo Fisher Scientific Service for Dionex HPLC Products.

Message	Remedial Action
(x) counts deviation in zero position	<i>(where x is the exact deviation from the zero position.)</i> Turn the pump off and on again by pressing the power switch on the rear panel. Contact Service if the message appears more often.
All flows need to be stopped before servicing the pistons.	You tried to move the pistons of the pump into the position for piston or piston seal replacement although the flow rate was not yet down to zero. Set the pump flow rate to 0. Wait until the system pressure is down to zero.
An emergency stop was requested over the digital input line	This message appears if a Corona detector is connected to the pump and the digital input is configured to stop the pump when an error occurs in the detector. Check the detector and take appropriate remedial action (→ <i>Detector manual</i>).
Can't do this when the flow is on.	You tried to perform a self test although the flow rate was not yet down to zero. Set the pump flow rate to 0 and repeat the command.

Message	Remedial Action
Can't reset pressure sensor. Pressure is not constant.	The pump pressure is not down to zero during the self test. Wait until the pressure is down and repeat the test. Verify that the cable for the system pressure transducer is properly connected to the P-Sys connector on the interior front panel.
Can't reset pressure sensor. Pressure is out of range.	The pump pressure is not down to zero during the self test. Wait until the pressure is down and repeat the test. Verify that the cable for the system pressure transducer is properly connected to the P-Sys connector on the interior front panel.
Can't start pump while alarm is on.	An alarm has occurred, for example, a leak alarm. You can restart the pump flow only after having acknowledged the alarm, for example, by performing the AlarmOff command in Chromeleon.
Configuration error: Found <i>x</i> ID chips and <i>y</i> pump blocks.	<i>(where x and y are numbers)</i> A pump block may be defective. Contact Service.
Degasser malfunction	<i>LPG-3400</i> The vacuum level monitoring function of the degasser in the pump recognized insufficient vacuum. Turn the pump off and on again by pressing the power switch on the rear of the module. Check the degasser vacuum in Chromeleon (Commands dialog box). After about 1 minute, the setting should change from NotOk to OK. Inspect the degassing module for indications of leakage if the vacuum is still insufficient. The degassing module may be defective and should be replaced by your Service representative. <i>Pumps to which a SRD-3x00 Solvent Rack is connected</i> The vacuum level monitoring function of the degasser in the Solvent Rack was activated. The vacuum level is insufficient. The degasser may not be connected properly to the pump. Verify that the Solvent Rack is properly connected to the pump. Turn the Solvent Rack off and on again by pressing the standby button on the front panel. The degassing module may be defective and should be replaced by your Service representative.
I2C device <i>xx</i> does not work	<i>(where xx is a number indicating the device. The number is important for servicing.)</i> Turn the pump off and on again by pressing the power switch on the rear panel.
Internal pump maintenance is due, please open purge screw and purge	Internal pump maintenance is overdue and has not been performed for more than 45 days. Open the purge screw and initiate a purge cycle.
Leak detected	<i>When this message appears, the flow is automatically turned off after 180 seconds.</i> The leak sensor has reported a leak. Find and eliminate the source for the leak. Dry the leak sensor and tray (→ page 137).

Message	Remedial Action
Motor current too large	<p>The motor current is too high when the pump is running.</p> <p>The flow path before the transducer for the system pressure may be blocked. Make sure that neither the capillary from the working cylinder to the equilibration cylinder nor the capillary to the purge unit is blocked. Replace the capillaries if necessary.</p> <p>Verify that the check valve cartridges are installed in the direction of flow (→ page 141).</p> <p>Inspect the purge valve for indications of blockage. Replace the purge valve screw if necessary (→ page 171).</p> <p>The motor may be defective. Contact Service.</p>
No abortable command was executing.	An attempt was made to perform an Abort command. However, no action or command was being executed that can be aborted.
Position error	<p>A position error is reported for the pump.</p> <p>Turn the pump off and on again by pressing the power switch on the rear panel. Contact Service if the message appears again.</p>
Pressure buildup during maintenance operation. Please open the purge valve.	<p>A pressure of more than 0.5 MPa built up during piston and/or piston seal maintenance. Open the purge valve to reduce the pressure. If you are operating an ISO-3100BM, observe the precautions on page 101.</p> <p>If the message appears during the internal maintenance procedure (→ page 111), perform an additional purge cycle (→ page 65).</p>
Pressure fallen below lower limit	<p>The solvent reservoirs are empty. Fill the reservoirs and purge the system (→ page 65).</p> <p>There are air bubbles in solvent supply line. Check the filter frits; purge the system (→ page 65).</p> <p>The solvent emits gas when mixing. Degas the solvent. Check the degasser.</p> <p>There is a leak in the system. Find and eliminate the source for the leak. Tighten loose connections.</p> <p>One of the check valves is defective. Check and replace the valve cartridges as appropriate (→ page 141). Purge the system (→ page 65).</p> <p>The lower pressure limit cannot be reached for the specified flow. The main task of the lower pressure limit is to monitor the system for leakage. Leakage may occur especially at the fittings and or screw joints, the switching valve in the autosampler, or the piston seals.</p>
Pressure recalibration deviates by xx bar	<p>The message appears if, during the self test or when performing the SetPressureZero command, the pressure deviates by more than 2 MPa from the former value.</p> <p>The pump pressure is not down to zero during the self test or during execution of the SetPressureZero command. Wait until the pressure is down and repeat the test or command. Verify that the cable for the system pressure transducer is properly connected to the P-Sys connector on the interior front panel.</p>

Message	Remedial Action
Pressure sensor malfunction	The pressure transducer for the system pressure reported a pressure under 0 MPa. Verify that the cable for the system pressure transducer is properly connected to the P-Sys connector on the interior front panel.
Pump drive flow limit exceeded.	The message appears for an HPG-3200BX if the flow rate is set to a value above the allowed range. Check and change the flow rate setting or the solvent composition if required. Observe the information for the Double Flow mode (→ page 102).
Purge pressure limit exceeded.	After you have initiated purging in Chromeleon (Purge property set to On), a pressure of more than 5 MPa built up. Open the purge valve if it is not yet open. If you are operating an ISO-3100BM, observe the precautions on page 101. Check the flow path for indications of blockage (also, see "Upper pressure limit exceeded").
Quiescent current too large	The motor current is too high when the pump is stopping. Turn the pump off and on again by pressing the power switch on the rear panel.
Self test failed: xx	(where xx = additional text) <i>This message usually appears together with another message indicating which failure occurred during the self test. Refer to this message for recommended remedial actions.</i>
Solvent rack leak detected.	The leak sensor in the Solvent Rack has reported a leak. The degasser may not be connected properly to the pump. Verify that the Solvent Rack is properly connected to the pump. There is a leak in the system or a fluid connection is loose. Find and eliminate the source for the leak. Tighten leaking connections and dry the leak sensor (→ <i>Solvent Rack manual</i>).
The cam position is yet unknown. It is necessary to run at least 2 revolutions.	The position of the cam is unknown after the piston has been replaced. Turn on the flow and have the pump run for two revolutions to establish the position.
The piston seal leakage has exceeded the recommended limit.	Inspect the piston seals for leakage (→ page 149). Replace the piston seals (→ page 155).

Message	Remedial Action
<p>The pressure exceeded the absolute limit.</p>	<p>The pressure has exceeded the absolute pressure limit. This message appears when pressure builds up extremely fast.</p> <p>This may happen, for example - When the pump delivers at a high flow rate while the pump outlet is closed with a fitting plug. - If a pump with a low-volume mixing system (mixing volume $\leq 200 \mu\text{L}$) delivers at a high volume rate and the valve in the autosampler switches from Load to Inject or vice versa.</p> <p>Take appropriate remedial action and retry.</p>
<p>The pressure signals are not consistent. Air may be trapped in the working cylinder.</p>	<p>The error can be due to large amounts of air in the pump heads, for example, during initial installation.</p> <p>Verify that the pressure transducer cable of the pump head is properly connected to the P-Work connector on the interior front panel.</p> <p>Purge both pump heads thoroughly (→ page 65).</p> <p>Perform a self test if necessary.</p>
<p>The pump drive is still in maintenance position.</p>	<p>An attempt was made to start the pump while the pump is still in maintenance position, for example, during piston replacement or piston seal replacement. Return the pistons into the position for normal operation (→ page 153) and retry.</p> <p>If the message appears during the internal maintenance procedure (→ page 111), perform an additional purge cycle (→ page 65).</p>
<p>The rear seal leak sensor detects drops constantly.</p>	<p>Verify that the pump is installed in a horizontal position and that the seal wash solution can run properly to the waste.</p> <p>Remove the detector of the seal wash system (→ page 140). Verify that the detector seat is dry, for example, by using a lint-free cloth or tissue.</p> <p>Inspect the electrodes of the seal wash detector for indications of contamination. Clean the detector electrodes as necessary (→ page 140).</p> <p>The message appears also if the seal wash system is equipped with the NP detector <i>and</i> the wash solution has too high a water portion. Observe the precautions for the composition of the seal wash solution (→ page 95).</p> <p>Install the RP detector (→ page 140) and observe the information for the composition of the seal wash solution (→ page 95).</p> <p>If the above actions are not successful and if the message continues to appear, the detector of the seal wash system may be defective. Replace the detector (→ page 140).</p>

Message	Remedial Action
The rear seal wash system has run out of wash solution	<p>Rear seal washing is enabled and the peristaltic pump is running, but no liquid reaches the detector of the seal wash system.</p> <p>Verify that wash solution is present in the seal wash reservoir.</p> <p>Initiate another Wash cycle manually. To do so, set RearSealWashPump to Active (→ page 94).</p> <p>Verify that the seal wash tubing is connected properly (→ Fig. 4, page 26) and check the tubing for permeability. Replace the seal wash tubing <i>and</i> the tubing connectors as necessary.</p> <p>The peristaltic tubing may be blocked or draws air. Replace the tubing if necessary (→ page 139).</p> <p>Inspect the rear seal wash tubing for indications of leakage (→ page 138). Replace the seal wash tubing <i>and</i> the tubing connectors as necessary.</p> <p>Verify that the lever of the peristaltic pump (→ Fig. 34, page 139) is not blocked.</p> <p>Inspect the electrodes of the seal wash detector for indications of contamination. Clean the detector electrodes if necessary (→ page 140).</p> <p>Make sure that the seal wash solution is sufficiently conductive (→ page 95).</p>
Undock err., open purge valve	<p>(Usually, also the pump block status LED flashes red.)</p> <p>The pistons are not in the appropriate position for normal operation (for example, after piston (seal) replacement) or an error occurred during internal maintenance (→ page 111).</p> <p>Open the purge valve (with an ISO-3100BM, observing the precautions on page 101), perform the Dock Pistons command, and close the purge valve.</p>
Upper pressure limit exceeded	<p>Check whether the flow path is blocked. Open the purge valve. If you are operating an ISO-3100BM, observe the information on page 101.</p> <p>If the flow path is blocked</p> <ul style="list-style-type: none"> - The column may be contaminated. Rinse or replace the column. If the problem occurs due to column ageing, it may be sufficient to increase the setting for the upper pressure limit. - The autosampler may be blocked. Find and eliminate the source for the blockage. <p>If the flow path is <i>not</i> blocked</p> <p>Depending on the pump type, check the static mixer or inline filter for indications of blockage (→ page 166 or 170).</p>
Working piston zero pressure out of range.	<p>Verify that the pressure transducer cable of the pump head is properly connected to the P-Work connector on the interior front panel.</p>
Zero position not found during the last revolution.	<p>Turn the pump off and on again by pressing the power switch on the rear panel. Contact Service if the message appears more often.</p>
Zero position not found during the last 3 revolutions.	<p>Turn the pump off and on again by pressing the power switch on the rear panel. Contact Service if the message appears more often.</p>

When the pump is operated from Chromeleon and if communication between Chromeleon and the pump cannot be established, messages appear in the Chromeleon Audit Trail.

Message	Remedial Action
HPG-3400USB-1610103 - Device not found on the USB	The USB connection between the pump and the Chromeleon server may be interrupted. Check the USB connection. The power supply to the pump may be interrupted. Check the power supply connection of the pump. Restart the Chromeleon Server Monitor and/or the Chromeleon server.
Error opening HPG-3400 @USB-1610103 – The System cannot find the file specified	The USB connection between the pump and the Chromeleon server may be interrupted. Check the USB connection. The power supply to the pump may be interrupted. Check the power supply connection of the pump.
Error issuing control request to HPG-3400@USB-1610103	The USB connection between the pump and the Chromeleon server may be interrupted. Check the USB connection. Check the power supply connection of the pump. Remove the pump specified in the message from the server configuration or else, select a different pump from the list of available pumps in the server configuration program.
Error reading from HPG-3400 @USB-1610103 Data error (cyclic redundancy check)	Check the USB connection. The connection to the next hub must not exceed 5 m. The overall connection length, including the hub connections must not exceed 30 m. Replace defective USB cables. Replace a defective USB hub.
Error reading from HPG-3400 @USB-1610103	The USB connection between the pump and the Chromeleon server may be interrupted. Check the USB connection. The power supply to the pump may be interrupted. Check the power supply connection of the pump.

6.4 Chromeleon Diagnostics Messages

If the pump fails a diagnostics test, perform the instructions given here and repeat the test. If the test fails again, contact Thermo Fisher Scientific Service for Dionex HPLC Products.

Degasser Vacuum Test failed

Probable Cause	Remedial Action
The degasser module did not reach the appropriate operating vacuum.	Check the tubing of the vacuum system and the degasser module and repeat the test. If the test fails again, the degasser module may be defective. Contact Service.

Mixer Frit Test failed

Probable Cause	Remedial Action
The backpressure has exceeded the limit. The static mixer or inline filter may be blocked.	<p><i>All pumps except LPG-3400BM and DGP-3600BM</i> Depending on the pump type, replace the static mixer (→ page 165) or inline filter (→ page 167).</p> <p><i>LPG-3400BM and DGP-3600 BM</i> Replace the inline filter (→ page 168) or the frit in the inline filter (→ page 169).</p>

General Leak Test failed

Probable Cause	Remedial Action
The pressure drop has been too high.	<p>Check the fitting plug on the pump outlet for tightness. Visually inspect all fluid connections for liquid droplets. Check all fluid connections for indications of leakage. Replace the valve cartridge (inlet check valve) (→ page 141). If you still suspect there is a leak, run the detailed leak test.</p>
The pressure level has not been reached in time.	
The initial pressure has not been reached within the first minute.	
The pressure drop during relaxation has been too high.	

Detailed Leak Test failed

Probable Cause	Remedial Action
The check valve has a leak.	Replace the valve cartridge (outlet check valve) (→ page 141) and repeat the test. Replace the valve cartridge (inlet check valve) (→ page 141) and repeat the test.
The piston seals are leaking.	Replace the piston seals (→ page 155).

Performance Test failed

Test Result	Probable Cause	Remedial Action
The pressure/% compression was outside specification!	Eluent may not have been degassed correctly. It is likely that the wrong eluent was chosen in test step 1 (Prepare Pump). There may be air bubbles in the pump head. The check valves may not be working correctly. The piston seals are leaking. Backpressure may have fluctuated due to problems with the restrictor. The restrictor may be blocked.	Degas the eluent. Repeat the test. Make sure that the correct eluent is chosen. Purge the pump (→ page 65). Replace the valve cartridges (→ page 141). Replace the piston seals (→ page 155). Replace the restrictor.
The pressure was outside specification.	The pressure was outside the upper and lower pressure limits.	Repeat the test with changed flow settings.
The % compression value was over the limit!	There may be air bubbles in the pump head. The flow may have been too high.	Purge the pump (→ page 65). Repeat the test with reduced flow.
The % compression value was below the limit!	The flow may have been too low.	Repeat the test with increased flow.
Pressure ripple was too high.	There may be a mechanical fault.	Repeat the test. If the test fails again, contact Service.
The pulse damper may not work properly.	The pulse damper or the pulse damper membrane is defective or the pulse damper does not contain sufficient liquid.	Repeat the test. If the test fails again, contact Service.

6.5 Operating Problems

The table provides information about common operating problems that might occur with the pump or an UltiMate 3000 system and lists probable causes, as well as remedial actions.

For more information and remedial actions, see the manuals for the other modules of the UltiMate 3000 system.

Problem	Probable Cause	Remedial Action
No information appears on the pump display.	<p>The pump is not connected to the mains.</p> <p>The power is turned off.</p> <p>The pump is in standby mode.</p> <p>The screen brightness or contrast is not adjusted correctly.</p> <p>The fuses blow.</p> <p>Replacement fuse blows immediately.</p> <p>An error occurred in the electronic system.</p>	<p>Connect the power cord.</p> <p>Turn on the power to the pump.</p> <p>Press the Standby key on the front panel.</p> <p>Adjust the brightness and/or contrast (→ page 97).</p> <p>Replace the fuses (→ page 174).</p> <p>Contact Service.</p> <p>Contact Service.</p>
The pump does not work correctly when operated from Chromeleon.	<p>There is no connection between the pump and the Chromeleon computer.</p> <p>The USB port on the computer is not ready for operation.</p>	<p>Check the USB cable and connection to the computer.</p> <p>Check the USB port on the computer.</p>
The rear seal wash system is leaking.	The tubing of the seal wash system is not connected properly; the tubing is damaged by bending or is blocked.	Check the seal wash tubing (→ Fig. 4, page 26). Replace the tubing if required.
The degasser of a SRD-3x00 Solvent Rack that is connected to the pump cannot be turned on from the pump.	The degasser is not configured in the Properties dialog for the pump.	In the Chromeleon Server Configuration program, verify on the Devices page of the properties dialog for the pump that Degasser Control is set to External (→ page 44).

Problem	Probable Cause	Remedial Action
<p>The degasser of a SRD-3x00 Solvent Rack that is connected to the pump does not work (the Vacuum and Status LED on the Solvent Rack are off).</p>	<p>The Solvent Rack is not connected properly to the pump and/or the degasser is not configured in the Properties dialog for the pump.</p> <p>The degasser is turned off.</p> <p>A first generation SRD-3x00 Solvent Rack is connected to the pump.</p>	<p>Verify both that the Solvent Rack is connected properly to the pump and that Degasser Control is set to External in the properties dialog for the pump (→ page 44).</p> <p>Turn the degasser on.</p> <p>Contact Service.</p>
<p>The system has very high backpressure.</p>	<p>One or more capillaries in the system are blocked or damaged by bending.</p> <p><i>Depending on the pump type:</i> The static mixer or inline filter is blocked.</p> <p>The column is contaminated or blocked.</p>	<p>Check the capillaries in the system systematically from the detector to the pump. Replace the capillaries if needed.</p> <p>Replace the static mixer (→ page 165) or inline filter (→ page 167 or 168). With a LPG-3400BM and DGP-3600BM, you can replace the filter frit in the inline filter instead (→ page 169).</p> <p>Rinse or replace the column.</p>
<p>High baseline drift</p>	<p>The column is contaminated.</p> <p>The system is not sufficiently equilibrated.</p> <p>The eluents are degraded or inhomogeneous.</p> <p>The mobile phase is delivered in circles.</p>	<p>Clean or replace the column.</p> <p>Flush the system until equilibration. Usually, a volume of 5–10 times the column volume will be sufficient.</p> <p>Before you start an analysis, be sure that the eluents are already homogenized in the reservoirs. Use fresh solvent and check the eluent filter frits. In aqueous solvents, growth of microorganisms is possible.</p> <p>Direct the mobile phase to waste.</p>

Problem	Probable Cause	Remedial Action
High baseline drift (Cont'd)	The environmental conditions are unstable. For additional causes, see the operating instructions for the detector.	Make sure that the temperature and the humidity are constant. Avoid draft. Verify on the detector that the lamp and flow cell covers are in proper position and that the front panel door is closed. → <i>Detector manual</i>
High noise level, non-periodic baseline fluctuation	The eluent is degraded or of poor quality/purity. For additional causes, see the operating instructions for the detector.	Use fresh solvent. Use fresh and appropriate solvents (HPLC grade). → <i>Detector manual</i>
Periodic baseline fluctuation, pulsation	There are pressure fluctuations from the pump. There are air bubbles in the system. <i>ISO-3100BM</i> The membrane in the pulse damper is defective.	Purge the pump (→ page 65). Purge the pump (→ page 65). Contact Service.
Pressure pulsation or inconstant pressure	The solvent is not degassed sufficiently. The solvent is degraded. There are pressure fluctuations from the pump. There are air bubbles in the system. The inlet valve or outlet valve on the working cylinder is dirty.	Degas the eluent. Use fresh solvent. Purge the pump (→ page 65). Check the compression values for the pump and perform the remedial actions as suggested (→ page 134). Purge the pump (→ page 65). Clean the inlet check valve and/or outlet check valve. Replace the check valve (→ page 141).

Problem	Probable Cause	Remedial Action
<p>Pressure pulsation or inconstant pressure (<i>Cont'd</i>)</p>	<p>After a maintenance procedure (replacement of pump head, piston, or piston seal) the pistons are not in the appropriate position for normal operation.</p> <p><i>Depending on the pump type:</i> The static mixer or inline filter is blocked.</p> <p><i>ISO-3100BM</i> The pulse damper is defective.</p>	<p>Remove and reinstall the pistons (→ pages 150 and 152).</p> <p>Replace the static mixer (→ page 165) or inline filter (→ page 167 or 168). With a LPG-3400BM and DGP-3600BM, you can replace the filter frit in the inline filter instead (→ page 169).</p> <p>Contact Service.</p>
<p>Peak tailing</p>	<p>Too large extra column volume.</p> <p>There are poor capillary connections.</p>	<p>Use short capillaries. Use capillaries with an appropriate inner diameter (0.13 mm with UHPLC columns; 0.18 mm with conventional HPLC columns.)</p> <p>Replace the capillaries. Consider using Viper capillaries.</p>
<p>Peak Broadening, increased dead time</p>	<p>The inner diameter of the capillary to the detector is too large.</p> <p>The filter frits on the solvent supply line filters are clogged.</p> <p>The capillaries are clogged or there a poor capillary connections.</p> <p>The sample loop is clogged.</p> <p>The proportioning valve is defective.</p> <p>The column is overloaded or contaminated.</p> <p>The eluent has changed.</p>	<p>Use a capillary with an appropriate inner diameter.</p> <p>Check the filter for permeability. Replace the filter frit if necessary (→ page 58).</p> <p>Replace the capillaries. Consider using Viper capillaries.</p> <p>Replace the sample loop (→ <i>Autosampler manual</i>).</p> <p>Contact Service.</p> <p>Clean or replace the column.</p> <p>Use fresh solvent.</p>

Problem	Probable Cause	Remedial Action
Reproducible ghost peaks in the chromatogram.	<p>The degassing channels are contaminated.</p> <p>The eluents are degraded, dirty or of poor purity/quality.</p> <p>Contamination occurs somewhere in the system.</p>	<p>Rinse the degassing channels (→ page 175 or <i>Solvent Rack manual</i>).</p> <p>Use fresh solvent. Use fresh and appropriate solvents (HPLC grade).</p> <p>Flush the system with an appropriate solvent.</p>
Additional peaks appear in the injection peak.	<p>With gradients, the equilibration time after the flush cycle is too short.</p> <p>There is excessive dead volume.</p>	<p>Extend the equilibration time.</p> <p>Eliminate any dead volume.</p>
Spikes	<p>There is electrical interference from other modules.</p> <p>For additional causes, see the operating instructions for the detector and for the column compartment.</p>	<p>Isolate the electrical circuit from strong current consumers. Consider installing an uninterruptible power supply (UPS).</p> <p>→ <i>Detector manual</i> → <i>TCC manual</i></p>
Negative peaks	<p>Sample solvent and mobile phase differ in composition.</p> <p>The absorption of the solute is lower than the absorption of mobile phase.</p>	<p>Dissolve the sample in the mobile phase.</p> <p>Select a different wavelength. Use a mobile phase with less UV background absorption.</p>
Poor peak area precision	<p>The capillary connections are not installed properly or they are not tight.</p> <p>There are dead volumes in the capillary connections.</p>	<p>Check and tighten the capillary connections. Consider using Viper capillaries.</p> <p>Replace the needle seat (→ <i>Autosampler manual</i>).</p> <p>Replace the needle (→ <i>Autosampler manual</i>).</p> <p>Replace the conventional (non-Viper) fittings. Make sure that the capillaries are installed correctly. Consider using Viper capillaries.</p>

Problem	Probable Cause	Remedial Action
<p>Poor peak area precision (Cont'd)</p>	<p>The piston seals are leaking.</p> <p>There is air in the working cylinder.</p> <p>There is pump pulsation.</p> <p>The gradient is irreproducible.</p> <p>There are shifts in retention times.</p> <p>The sample is unstable and decomposes.</p> <p>Baseline fluctuations</p> <p>The environmental conditions are unstable.</p> <p>Contamination occurs somewhere in the system.</p> <p>For additional causes, see the autosampler manual.</p>	<p>Replace the piston seals (→ page 155).</p> <p>Purge the pump (→ page 65).</p> <p>Use degassed solvents.</p> <p>Check the compression value for the pump head (→ page 141).</p> <p>Change the gradient.</p> <p>Check the pump function and degassing.</p> <p>Check the filter frits in the solvent line filters for contamination. Replace the frits if necessary.</p> <p>Check the compression value for the pump head (→ page 141).</p> <p>Use new sample or change the conditions. Cool the sample in the autosampler if possible.</p> <p>See the remedial actions provided in the related baseline sections further up in this table.</p> <p>Make sure that the temperature and the humidity are constant. Avoid draft. Consider using a thermostatted column compartment.</p> <p>Flush the system with an appropriate solvent.</p> <p>→ <i>Autosampler manual</i></p>

Problem	Probable Cause	Remedial Action
No flow	<p>The system is leaking.</p> <p>The eluents are degraded, dirty or of poor purity/quality.</p> <p>Contamination occurs somewhere in the system.</p> <p>One or both valve cartridges are not installed correctly (not in the direction of flow) or are defective.</p> <p>There are air bubbles in the eluent or in the pump head.</p> <p><i>Depending on the pump type:</i> The static mixer or inline filter is blocked.</p> <p>There are air bubbles in the flow path.</p> <p>After a maintenance procedure (replacement of pump head, piston, or piston seal) the pistons are not in the appropriate position for normal operation.</p>	<p>Find and eliminate the leak.</p> <p>Use fresh solvent. Use fresh and appropriate solvents (at least HPLC grade).</p> <p>Flush the system with an appropriate solvent.</p> <p>Install the cartridges in the direction of flow or replace the cartridges if necessary (→ page 141).</p> <p>Purge the pump (→ page 65) and check the degasser.</p> <p>Replace the static mixer (→ page 165) or inline filter (→ page 167 or 168). With a LPG-3400BM and DGP-3600BM, you can replace the filter frit in the inline filter instead (→ page 169).</p> <p>Perform a wash cycle (→ <i>Autosampler manual</i>). Non-degassed wash solution is used. Degas the wash solution (→ <i>Autosampler manual</i>).</p> <p>Remove and reinstall the pistons (→ pages 150 and 152).</p>
Flow fluctuation	<p>The inlet path is blocked.</p> <p>There is air in the inlet path.</p> <p>The check valves are dirty or defective.</p> <p>The piston does not contact the magnet holder.</p> <p>The piston seals are leaking.</p>	<p>Check the inlet lines, filter of the pump, proportioning valve etc. for signs of blockage.</p> <p>Purge the pump (→ page 65) and check the degasser.</p> <p>Clean the check valves or replace the valve cartridges (→ page 141).</p> <p>Check whether the piston is installed correctly. Reinstall the piston (→ page 158).</p> <p>Replace the piston seals (→ page 155).</p>

Problem	Probable Cause	Remedial Action
Poor degassing	<p>There is a leak in the capillaries or solvent lines or there are loose connections.</p> <p>The degasser is not working properly.</p> <p>The flow rate is too high.</p>	<p>Inspect the capillary and solvent supply line connections for leakage; tighten loose fitting connections.</p> <p>Inspect the degasser for indications for leakage. Test the degasser vacuum.</p> <p>Reduce the flow rate.</p>
Degasser noise	<p>The vacuum pump of the degasser is running at high speed.</p>	<p>Fill and degas <i>all</i> channels (even if they are not used for the application).</p>

6.6 Checking the Compression Values

The compression value of the pump head can provide valuable information for troubleshooting. If you observe pump pulsation and/or shifts in retention times, check the compression values:

- On the pump display, select the **Diagnostics** menu and **Compression right** or **Compression left**.
- In Chromeleon, open the **Commands** dialog box for the pump and select **[Pump Device Name]_Wellness_LeftBlock** and **Compression** or **[Pump Device Name]_Wellness_RightBlock** and **Compression**. (For information about the [Pump Device Name], see page 45.)

The values are indicated in per cent and show the compression of the last stroke. The compression value should be lower than 100% and remain stable. If the value is close to 100%, the required precompression may not be reached and pulsation may occur.

The table shows guides values for some solvents:

Solvent	Compression*			
	RS Pumps	SD pumps	BM pumps	BX pump
Acetonitrile	45 % ± 10 %	70 % ± 10 %	75 % ± 10 %	23 % ± 5 %
Methanol	50 % ± 10 %	70 % ± 10 %	80 % ± 10 %	23 % ± 5 %
Water	25 % ± 10 %	50 % ± 10 %	55 % ± 10 %	18 % ± 5 %

* with 100 % of degassed solvent delivered at 40 MPa (BX pump: 10 MPa), pump purged and stable for some time. The values are linear to the pressure.

- If the compression value is lower than indicated in the table, the cartridge in the valve cartridge (outlet check valve) may be defective. Replace the cartridge (→ page 141).
- If the compression value is *higher* than indicated in the table
 - ◆ The piston seals may be defective. Replace the piston seals (→ page 155).
 - ◆ The valve cartridge (inlet check valve) may be defective. Replace the cartridge (→ page 141).
- If the compression is very high and the pressure is low, there may be air bubbles in the system. Purge the pump (→ page 65).

7 Service

7.1 General Notes and Safety Precautions

The following sections describe all service and repair procedures that the user may perform. All other maintenance and service procedures must be performed only by Thermo Fisher Scientific service personnel

 **Warning:** The fluid components of the device may be filled with solvents that are harmful to health. Wear appropriate personal protective equipment. Rinse the fluid components with an appropriate solvent to remove harmful substances.

For information about the proper handling of a particular substance and for advice on specific hazards, refer to the material safety data sheet for the substance you are using. Observe the guidelines of Good Laboratory Practice (GLP).

 **Avertissement:** Les composants fluidiques de l'instrument peuvent être remplis de solvants nocifs. Portez l'équipement de protection personnel approprié. Rincez les composants fluidiques avec un solvant approprié afin d'éliminer les substances nocives.

Pour les informations sur la manipulation correcte des composés et des recommandations pour les situations de risque spécifiques, veuillez consulter la fiche de données de sécurité des substances que vous utilisez. Veuillez respecter des directives des Bonnes Pratiques de Laboratoire (BPL).

Before starting maintenance or service procedures, observe the following precautions:

- For all service and repair procedures, observe all precautionary statements provided in these operating instructions.
- *ISO-3100 and HPG-3200*
When the fluid components of the pump are filled with liquid and the solvent reservoirs are located above the pump outlet during pump operation, the hydrostatic pressure in the system may cause eluent to escape when you open a fluid connection in the pump. *Before* you open a fluid connection, position the reservoirs below the connection to be opened.
- Use only the original spare parts authorized for the device by Thermo Fisher Scientific.
- Before returning the pump for repair, contact Thermo Fisher Scientific Service for Dionex HPLC Products. An RMA (Return Material Authorization) number is required to track your module. Always use the original packaging and observe the packing instructions when shipping the module. Shipping the module in anything other than the original packaging voids the warranty.

If the original shipping container is not available, appropriate shipping containers and packing material can be ordered from Thermo Fisher Scientific sales organization for Dionex HPLC products. The packing instructions are included in the "Installation and Qualification Documents for Chromatography Instruments" binder and are available on request.

For instructions on shutting down the pump, see page 109.

i **Tip:** Do not forget to test the pump for leakage after you have carried out maintenance or repair work on the fluid connections (→ page 172).

7.2 Eliminating Leakage

The leak sensor reports a leak when liquid collects in the drip tray under the fluid connections. Locate the source for the leak, eliminate the cause, and dry the leak sensor.



Fig. 32: Leak sensor

1. Wait until the pressure is down to zero.
2. Inspect the fluid connections in the pump for signs of leakage. Tighten or replace leaking connections if necessary.
3. With a cloth or tissue, absorb all liquid that has collected in the tray. Be careful; do not bend or damage the sensor.
4. Allow the sensor to adjust to the ambient temperature for a few minutes. The red sensor LED should now be dark. (The yellow LED may be dark or illuminated; this LED does not indicate errors.)
5. If no errors are reported, you can resume operation.
6. Do not forget to test the pump for leakage after you have carried out maintenance or repair work on the fluid connections (→ page 172).

i **Tip:** If the sensor is not dry, the Status LED remains red. If a message appeared on the front panel display, select **Clear** on the navigation bar to remove the message from the display.

7.3 Rear Seal Wash System

7.3.1 Inspecting the Rear Seal Wash System for Leakage

1. Remove the seal wash tubing from the detector.

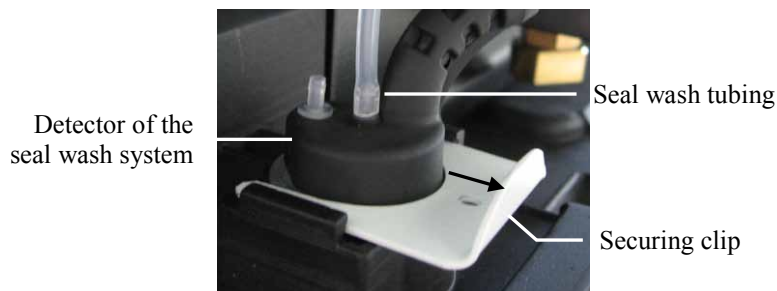

Fig. 33: Detector of the seal wash system

2. Draw seal wash solution into a syringe at the open end of the tubing. Press the lever of the peristaltic pump to the left so that the liquid can easily pass the system.
3. Press the lever of the peristaltic pump firmly onto the tubing, and then press liquid into the seal wash system from the syringe.
4. Inspect the tubing and connections of the seal wash system for indications of leakage. Tighten or replace leaking connections as necessary.

7.3.2 Replacing the Peristaltic Tubing

Description	Part No.
Peristaltic tubing (= PharMed tubing, white) from the Tubing Kit for the Rear Seal Wash System	6040.9502

1. First, remove the seal wash tubing from the seal wash reservoir to avoid liquid spill.
2. Remove the peristaltic tubing from the peristaltic pump. Press the lever to left, remove the tubing from the pump, and release the lever.

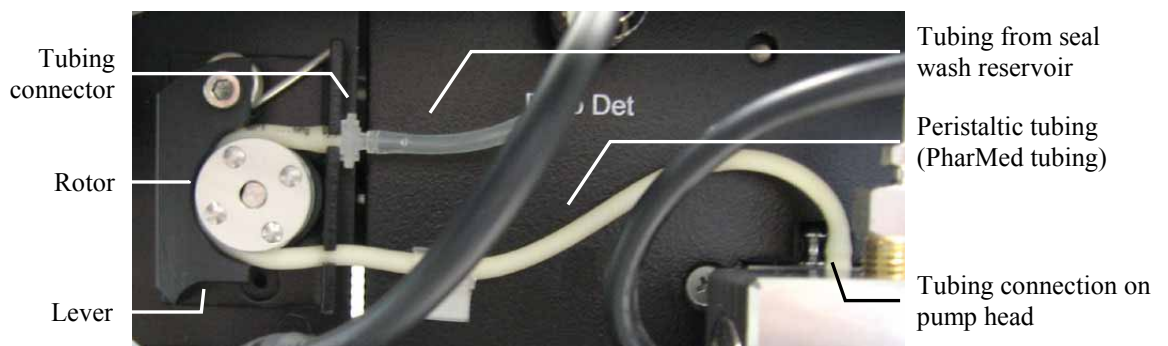

Fig. 34: Peristaltic pump

3. Disconnect the peristaltic tubing from the connection port on the pump head.
4. Disconnect the other end of the peristaltic tubing from the seal wash tubing (clear tubing).
5. Locate the PharMed tubing (white tubing) in the Tubing Kit for the Rear Seal Wash System and cut the tubing to the required length.
6. Connect the replacement tubing to the connection port on the pump head and to the tubing from the seal wash reservoir. Push the PharMed tubing onto the connector as far as it goes on (a small collar should be visible).
7. Engage the tubing in the peristaltic pump. Press the lever to left, place the tubing in the pump, and release the lever.
8. Update the service information in Chromeleon. Perform the **RearSealWashTubeChanged** command (→ page 103).

7.3.3 Replacing the Detector

Description	Part No.
Detector of the rear seal wash system Note the information for NP applications (→ page 95).	6040.4131

1. Remove the seal wash tubing from the detector (→ Fig. 33).
2. Unplug the detector cable from the **Drop Det** connector on the interior front panel.
3. Remove the securing clip for the detector toward you, and then remove the detector toward to top.
4. Install the replacement detector following the above steps in the reverse order.
Connect the seal wash tubing to the *inner* port (→ Fig. 33). The *outer* port has no function.

7.3.4 Cleaning the Detector Electrodes

The detector electrodes can be contaminated by deposits impairing the correct functioning of the seal wash system.

1. Remove the detector (→ section 7.3.3).
2. Clean the electrodes with distilled water and wait until they are dry. The electrodes in the detector are critical for proper operation. Therefore, be careful not to bend or otherwise damage them during cleaning.

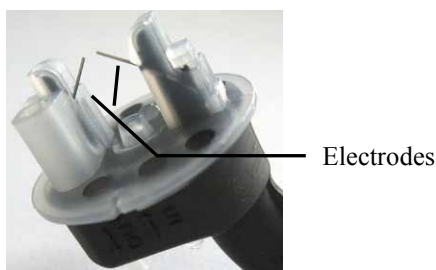

Fig. 35: Detector of the seal wash system

3. Reinstall the detector.

7.4 Replacing the Check Valve Cartridges

Two check valves are installed in the pump head: inlet check valve and outlet check valve (→ nos. 11 and 13 of Fig. 37, page 143 and/or Fig. 38, page 147).

Description	Part No.
Valve cartridge, ceramics (the cartridge is the same for both the inlet and outlet valve)	6041.2301
Valve nut kit (inlet check valve nut and outlet check valve nut) for SD pumps	6040.7007
RS, BM and BX pumps	6042.7007

1. If necessary, purge the pump to remove harmful solvents.
2. Set the pump flow rate to 0. Wait until the system pressure is down to zero.
3. Put on a pair of clean room gloves to prevent contamination on the valve parts. Even minute particles may cause damage to the system and result in poor pump performance.
4. Disconnect *all* tubing connections from the inlet and outlet check valves. Observe the information about the different fitting connections on page 55.
To remove the capillary on the outlet valve nut, consider disconnecting the other end of the capillary (on the rear (lower) connection port) first to facilitate the procedure.
5. Loosen the check valve nuts, by using an open-end wrench (size 13), and remove them from the pump head.
6. Hold the nuts over your hand and turn them upside down, allowing the cartridges to drop into your hand.
7. Insert a new cartridge into the check valve nut. Make sure that you insert the cartridge in the direction of solvent flow, as indicated by the arrow on the cartridge.
8. Screw the check valve into the pump head and tighten the check valve (recommended torque: 10 Nm). Do not overtighten; this will crush the cartridge.
Tighten the inlet check valve hand-tight (→ Fig. 36, page 142) and turn the bottom part so that the inlet opening faces backward.
Then, use an open-end wrench (size 13 mm) to tighten the nut until the inlet opening is on the left (about one-quarter turn).

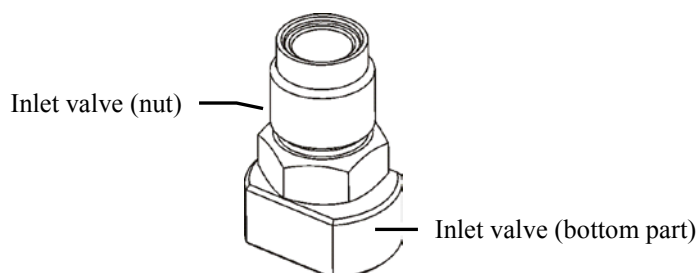

Fig. 36: Inlet check valve

9. Reconnect the tubing connections to the inlet and outlet check valve.

Inlet check valve

When you attach the solvent supply line to the inlet valve, take care to avoid cross-threading. If you observe leakage, tighten a little more.

Outlet check valve

RS pumps: Observe the information about the different Viper fitting connections on page 55.

SD, BM, and BX pumps: On the outlet check valve, tighten the tubing hand-tight, and then tighten it an additional one-quarter turn, by using a wrench. If you observe leakage, tighten a little more. Do not overtighten; this may cause damage to the capillary.

10. To prevent contaminants from entering the HPLC system, thoroughly rinse the pump (using at least 30 mL HPLC grade water or purely organic solution).
Open the purge valve (with an ISO-3100BM, observing the precautions on page 101) to prevent the rinsing liquid from entering the HPLC system.
11. Test the pump for leakage (→ page 172). Tighten leaking connections.
12. Update the service information in Chromeleon. Perform the **CheckValveServiceDone** command (→ page 103).

7.5 Pistons and Piston Seals

- Analytical and micro pumps: see below
- Semipreparative pump: see page 147

Analytical and micro pumps

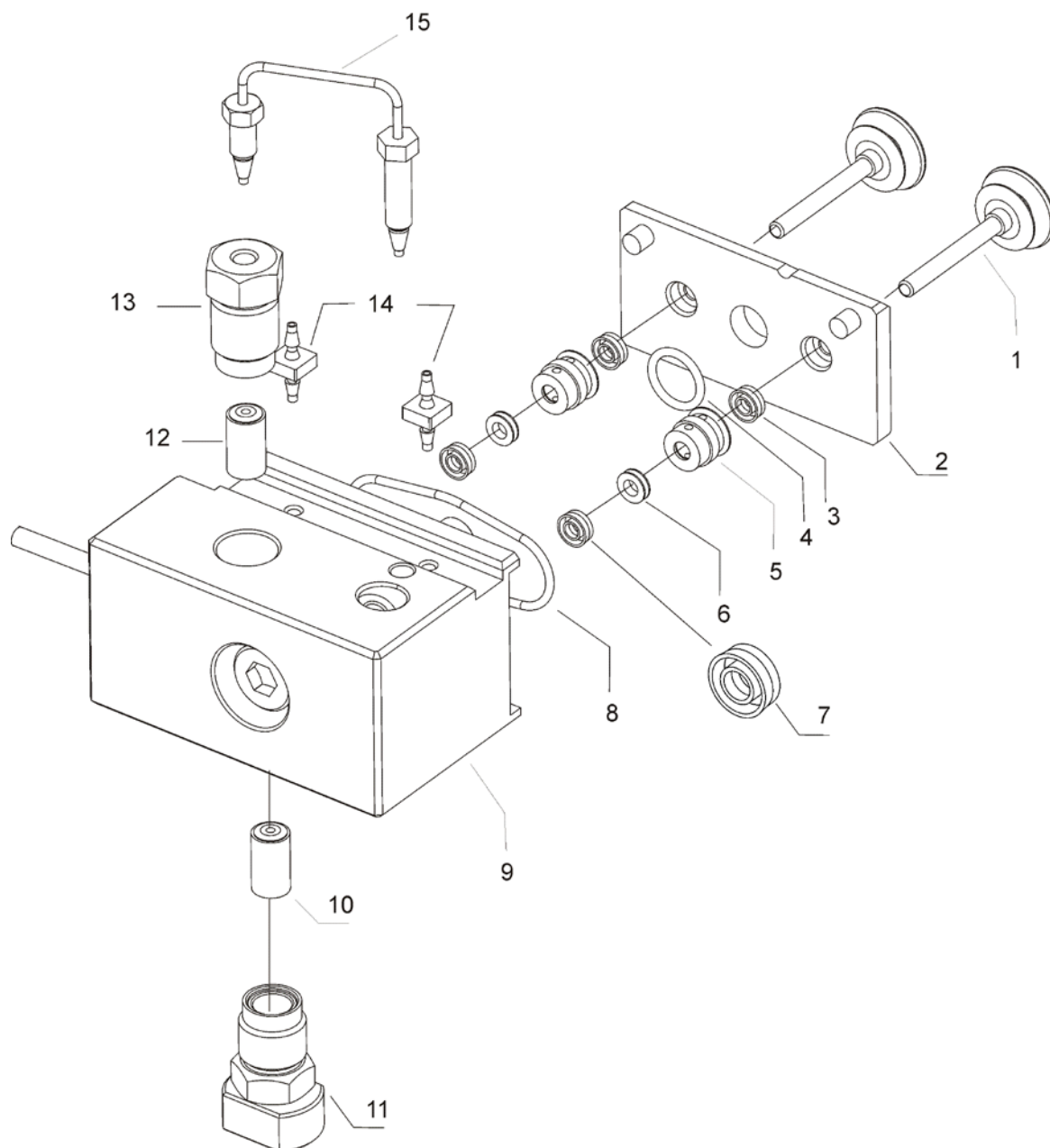

*Fig. 37: Pump head, pistons, and piston seals
(all pumps except HPG-3200BX)*

Depending on the pump version, the representation of a part may be different from the real part. However, the position of the parts is the same for all pump versions.

No.	Description	Part No.	
		HPG-3x00RS	HPG-3x00SD
	Pump head, entire assembly, with:	6040.1901B	6040.1903A
1	Piston (sapphire)	6040.0042	
2	Plate (seal wash system)	----	
3	Piston seal (in plate of seal wash system) (normal phase)	6040.0306	
4	Seal ring (rear seal wash system)	Included in 6040.2208	
5	Rear seal wash body (pump head bushing)	----	
6	Support ring of the piston seal	6040.0012	
7	Main piston seal (reversed phase)	6266.0305	6040.0304
8	Seal ring (rear seal wash system)	Included in 6040.2208	
9	Pump head	----	
10	Valve cartridge (same as no. 12)	6041.2301	
11	Valve nut (inlet check valve)	Included in 6042.7007	Included in 6040.7007
12	Valve cartridge (same as no. 10)	6041.2301	
13	Valve nut (outlet check valve)	Included in 6042.7007	Included in 6040.7007
14	Tubing connector for the seal wash tubing	Included in 6040.9502	
15	Capillary from working cylinder to equilibration cylinder (U-tube)	Included in 6040.3002	Included in 6040.3000

i **Tip:** For SD pumps, normal phase seals are available for the main piston seal as an option (part no. 6040.0306).

No.	Description	Part No.		
		LPG-3400RS DGP-3600RS	ISO-3100SD LPG-3400SD DGP-3600SD	LPG-3400SDN DGP-3600SDN
	Pump head, entire assembly, with:	6040.1902B	6040.1904A	See Tip further down.
1	Piston (sapphire)	6040.0042		
2	Plate (seal wash system)	----		
3	Piston seal (in plate of seal wash system) (normal phase)	6040.0306		
4	Seal ring (rear seal wash system)	Included in 6040.2208		
5	Rear seal wash body (pump head bushing)	----		
6	Support ring of the piston seal	6040.0012		
7	Main piston seal depending on the pump type Reversed Phase or Normal Phase	6266.0305 (Reversed Phase)	6040.0304 (Reversed Phase)	6040.0306 (Normal Phase)
8	Seal ring (rear seal wash system)	Included in 6040.2208		
9	Pump head	----		
10	Valve cartridge (same as no. 12)	6041.2301		
11	Valve nut (inlet check valve)	Included in 6042.7007	Included in 6040.7007	
12	Valve cartridge (same as no. 10)	6041.2301		
13	Valve nut (outlet check valve)	Included in 6042.7007	Included in 6040.7007	
14	Tubing connector for the seal wash tubing	Included in 6040.9502		
15	Capillary from working cylinder to equilibration cylinder (U-tube)	Included in 6040.3003	Included in 6040.3001	

i **Tips:** For SD pumps, normal phase seals are available for the main piston seal as an option (part no. 6040.0306).

SDN pumps

You can use the pump head (part no. 6040.1904A) also with SDN pumps. However, this pump head has reversed phase seals installed as main piston seals. Consider replacing these seals with normal phase seals (→ page 158).

No.	Description	Part No.
		LPG-3400BM DGP-3600BM ISO-3100BM
	Pump head, entire assembly, with:	6042.1902
1	Piston (sapphire)	6040.0042
2	Plate (seal wash system)	-----
3	Piston seal (in plate of seal wash system) (normal phase)	6040.0306
4	Seal ring (rear seal wash system)	Included in 6040.2208
5	Rear seal wash body (pump head bushing)	----
6	Support ring of the piston seal	Included in 6025.2012
7	Main piston seal (reversed phase)	Included in 6025.2012
8	Seal ring (rear seal wash system)	Included in 6040.2208
9	Pump head	----
10	Valve cartridge (same as no. 12)	6041.2301
11	Valve nut (inlet check valve)	Included in 6042.7007
12	Valve cartridge (same as no. 10)	6041.2301
13	Valve nut (outlet check valve)	Included in 6042.7007
14	Tubing connector for the seal wash tubing	Included in 6040.9502
15a	Capillary from working cylinder to equilibration cylinder (U-tube) LPG-3400BM and LPG-3600BM ISO-3100BM	Included in 6042.3001 Included in 6042.3002

Semipreparative pump

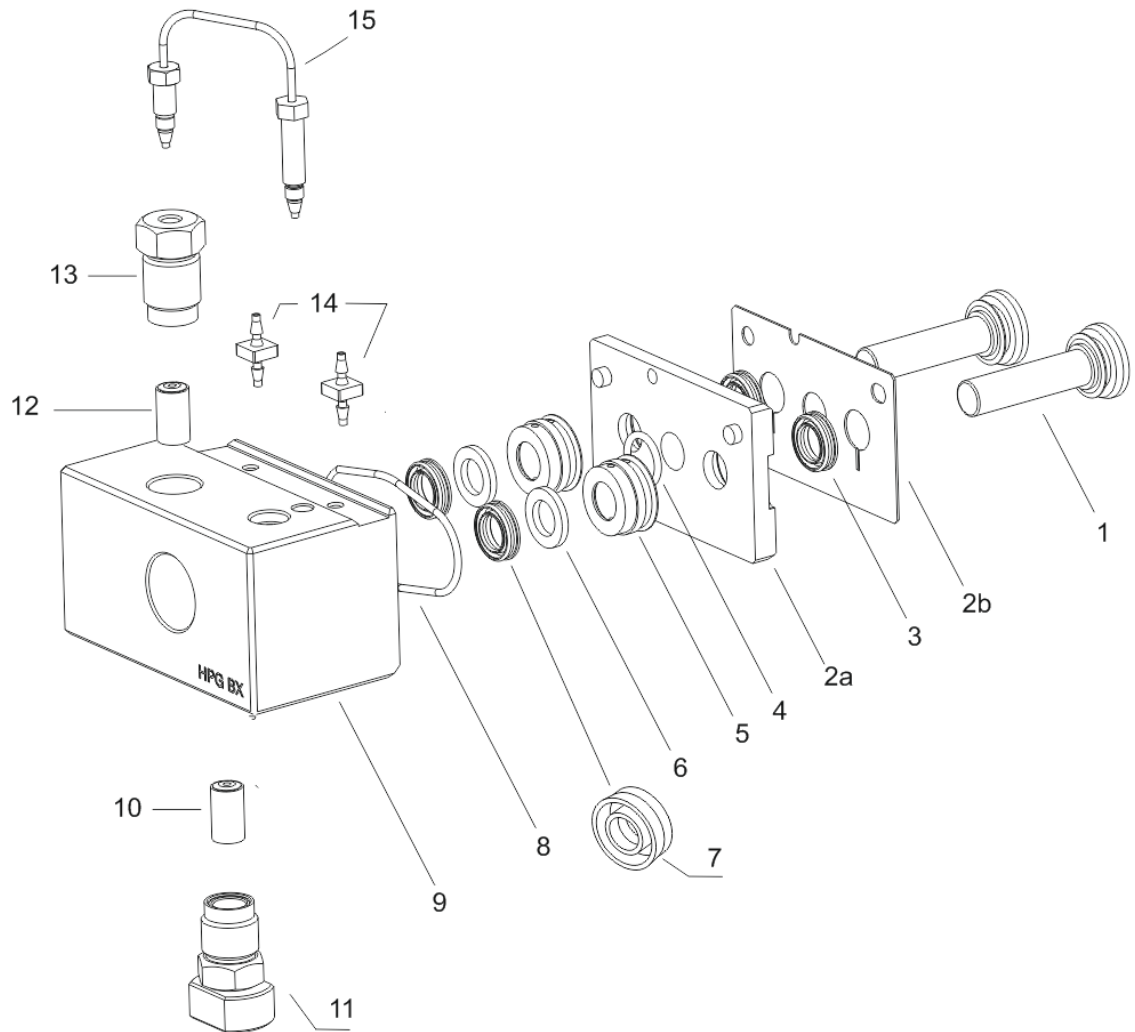

Fig. 38: Pump head, pistons, and piston seals (HPG-3200BX)

No.	Description	Part No.
		HPG-3200BX
	Pump head, entire assembly, with:	6042.1901
1	Piston (ceramics)	6040.0842
2a	Plate of the rear seal wash system	----
2b	Sheet of the rear seal wash system	----
3	Piston seal (in the plate of the seal wash system) (reversed phase)	Included in 6040.9010
4	Seal ring (rear seal wash system)	Included in 6040.2208
5	Rear seal wash body (pump head bushing)	----
6	Support ring of the piston seal	Included in 6040.9010
7	Main piston seal (reversed phase)	Included in 6040.9010
8	Seal ring (rear seal wash system)	----
9	Pump head	----
10	Valve cartridge (same as no. 12)	6041.2301
11	Valve nut (inlet check valve)	Included in 6042.7007
12	Valve cartridge (same as no. 10)	6041.2301
13	Valve nut (outlet check valve)	Included in 6042.7007
14	Tubing connector for the seal wash tubing	Included in 6040.9502
15	Capillary from working cylinder to equilibration cylinder (U-tube)	Included in 6042.3005

i **Tip:** Normal phase seals are available for the main piston seal as an option (part no. 6040.9011). The kit includes 2 normal phase seals and 1 support ring.

7.5.1 Visually Inspecting the Pump for Piston Seal Leakage

You can inspect the pump visually for liquid leaks from the piston seals.

1. Flush the rear seal wash system with the seal wash solution.
 - a) Remove the seal wash tubing from the detector.

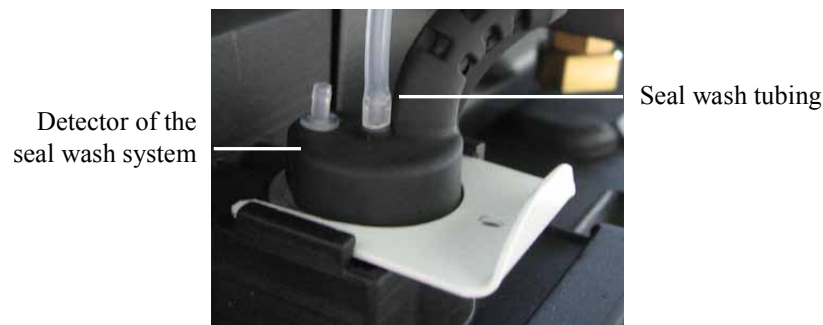

Fig. 39: Tubing connection on the seal wash detector

- b) Draw seal wash solution into a syringe at the open end of the tubing. Press the lever of the peristaltic pump to the left so that the liquid can easily pass the system.
 2. Remove some of the liquid by shaking the tube.
 3. Set the flow rate. Arrange the system in such a way that approximately 30 MPa of backpressure (BX pump: 5 MPa) is produced.
 4. To evaluate possible leakage, observe the air/liquid level in the silicone tube. Finish the observation before a new seal wash cycle starts.
 - ◆ If the level remains unchanged, the piston seals seal tightly. Proceed with the next step.
 - ◆ A rising level indicates leakage from one or more piston seals. Follow these steps:
 - a) On the right pump head, remove the seal wash tubing connecting the left pump head to the right pump head.
 - b) Repeat the observation.
 - c) If the level rises again, replace the piston seals in the left pump head (→ page 155) and repeat the test starting with step 1. If the level does not rise, replace the piston seals in the right pump head and repeat the test starting with step 1.
 - d) Reconnect the seal wash tubing to the right pump head.
 5. Reconnect the seal wash tubing to the detector.

Be sure to connect the tubing to the *inner* port (→ Fig. 39). The *outer* port has no function.

Tip: If leakage from a pump head is observed, check also the tubing connected to the rear seal wash system. If the seal wash tubing is not connected properly or if the tubing is crimped or kinked, the liquid may leak into the pump.

7.5.2 Pump Head and Pistons

7.5.2.1 Removing the Pump Head and Pistons

1. Tilt the front cover upward.
2. If necessary, purge the pump to remove harmful solvents.
3. Set the pump flow rate to 0 and wait until the system pressure is down to zero.
4. Move the pistons into the appropriate position for piston replacement. Perform the command for the pump head that you want to remove.
 - ◆ On the pump, perform the command for piston replacement on the **Control** menu, that is, depending on the pump type, perform the **Change pump pistons**, **Change right pump pistons**, or **Change left pump pistons** command. Wait until the **Pump/Maintenance** screen indicates that the pump head can be removed, before you continue with the next steps.
 - or—
 - ◆ In Chromeleon, perform the **UndockPistons** command from the Commands dialog box (listed under **[Pump Device Name]_Wellness_RightBlock** and/or **[Pump Device Name]_Wellness_LeftBlock**; for information about the [Pump Device Name], see page 45).
Wait until the **PistonPositionStatus** property reports **Undocked** before you continue with the next steps.
5. Undock the pistons of the second pump head if applicable.
6. *Only HPG-3x00*
Unplug the pressure transducer cable from the **P-Work** connector on the interior front panel.
7. Disconnect *all* fluid connections from the pump head. (It is not necessary to remove the U-tube, that is, the capillary from the working cylinder to the equilibration.)
Disconnect the capillary to the purge unit also on the purge unit if necessary.
Observe the information about the different fitting connections on page 55.

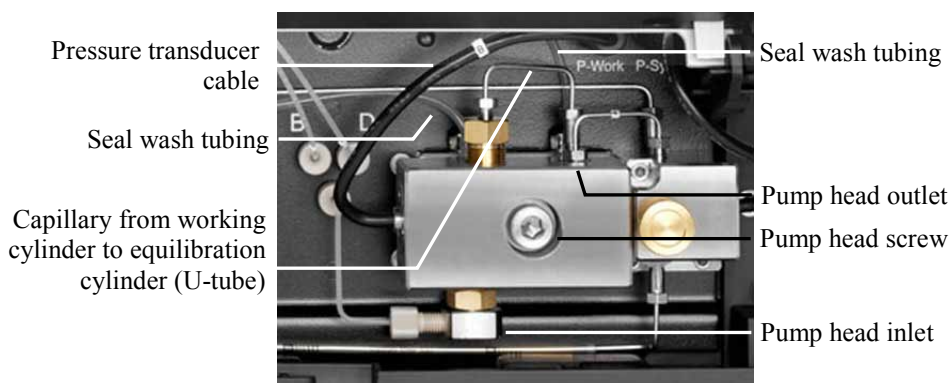

Fig. 40: Pump head

8. Loosen the pump head screw by using the hexagon wrench (size 6 mm) from the accessories kit of the pump.
9. Hold the pump head with one hand in its position, remove the pump head screw, and then remove the pump head toward you.

The pistons are removed from the pump together with the pump head. Hold down the plate of the rear seal wash system on the pump head and remove the pistons from the head.

If the plate of the rear seal wash system remains in the pump when you remove the pump head, do the following:

- a) Hook in the pump head tool at the lower edge of the plate (see further down). Carefully remove the plate from the pump block. The pump head tool is provided in the accessories kit of the pump.

◆ *All pumps except HPG-3200BX*

Hook in the tool at the *upper* edge of the plate.

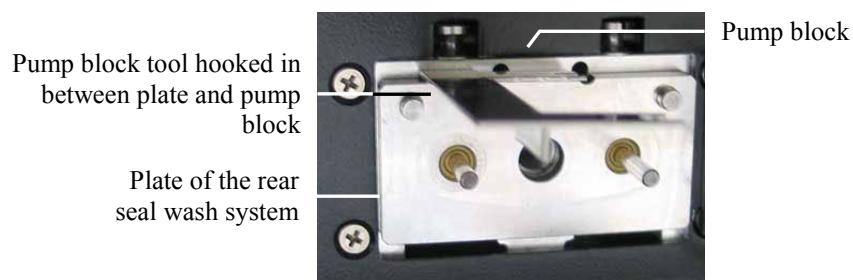

Fig. 41: Pump head tool, hooked in

◆ *HPG-3200BX*

Hook in the tool at the lower edge of the plate.

- b) *HPG-3200BX*

Verify that the sheet of the seal wash system (→ Fig. 38, no. 2b, page 147) has also been removed from the pump.

- c) Remove the pistons from the pump.

7.5.2.2 Installing the Pistons and Pump Head

Description	Part No.
Pump head (entire assembly) HPG-3x00RS HPG-3x00SD HPG-3200BX LPG-3400RS and DGP-3600RS ISO-3100SD, LPG-3400SD, and DGP-3600SD ISO-3100BM, LPG-3400BM, and DGP-3600BM	6040.1901B 6040.1903A 6042.1901 6040.1902B 6040.1904A ¹ 6042.1902
¹ This pump head has reversed phase seals installed as main piston seals. You can use the pump head also with SDN pumps. However, in this case, consider replacing the reversed phase seals with normal phase seals (→ page 158).	
Piston All pump types except HPG-3200BX (sapphire, 2 pistons) HPG-3200BX (ceramics, 2 pistons)	6040.0042 6040.0842

1. Only HPG-3200BX

Place the sheet of the rear seal wash system onto the plate of the seal wash system. Mind the correct orientation.

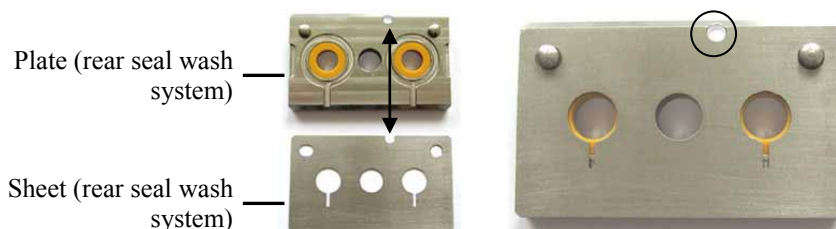

Fig. 42: Rear seal wash system: plate and sheet (HPG-3200BX)

- Place the plate of the rear seal wash system onto the pump head.
- Inject a few drops of isopropanol into the piston cavities.
- Use the pump head tool (spacing tool) to establish the correct distance between the piston and the plate of the rear seal wash system. (Appropriate pump head tools for the different pump types are provided in the accessories kit of the pumps.)

Place the spacing tool on the plate of the rear seal wash system, insert the pistons, and then push both pistons downward as far as possible. The distance is correct when both pistons touch the spacing tool. Remove the tool.



Fig. 43: Establishing the distance

5. Place the pump head back into the pump and tighten the pump head screw by using the hexagon wrench (size 6) from the accessories kit of the pump (recommended torque: 10 Nm).
If both pump heads were removed, be sure not to interchange them during reinstallation.
 - ◆ HPG-3x00: Note the label on the pressure transducer cable: A identifies the left pump head; B identifies the right head.
 - ◆ DGP-3600: Note the label (L or R) on the capillary from the working cylinder to the equilibration cylinder (U-tube).

i **Tip:** Replacement pump heads have no label. For easy identification for future maintenance, consider marking the replacement pump heads accordingly.
6. Reconnect the fluid connections on the pump head. Observe the following:
 - ◆ When installing the capillary from the pump head to the purge unit, be careful not to bend the capillary. Make sure that you install the capillary in the direction of solvent flow. Note that one side of the capillary is longer than the other is. Connect the longer side to the pump head. With some capillaries, the direction of the flow is indicated by an arrow on the capillary.
 - ◆ When you attach the solvent supply line to the inlet valve, take care to avoid cross-threading.
7. *Only HPG-3x00*
Reconnect the pressure transducer cable to the **P-Work** connector on the interior front panel.
Verify that the cable is properly connected. If it is not, messages relating the working pressure may appear on the pump display, for example, 'Working piston pressure out of range.'
8. Return the pistons into the appropriate position for normal operation. To do so, perform the appropriate command for the pump head that you want to install:
 - ◆ On the **Pump/Maintenance** screen on the pump display, select **Dock**. Wait until the screen returns to the Main menu before continuing with the next steps.

—or—

- ◆ In Chromeleon, perform the **DockPistons** command from the **Commands** dialog box (listed under **[Pump Device Name]_Wellness_RightBlock** and/or **[Pump Device Name]_Wellness_LeftBlock**; for information about the [Pump Device Name], see page 45). Wait until the **PistonPositionStatus** property reports **Operational** before you continue with the next steps.
9. Flush the pump head with seal wash solution (→ step 1 on page 149).
 10. Rinse the pump thoroughly to prevent contaminants from entering the HPLC system.
 - ◆ Rinse the pump with at least 30 mL of HPLC grade water or pure organic solution.
 - ◆ Open the purge valve (with an ISO-3100BM, observing the precautions on page 101) to prevent the rinsing liquid from entering the HPLC system.
 11. Test the pump for leakage (→ page 172). Tighten leaking connections.
 12. Update the service information in Chromeleon.

Perform the **PistonsChanged** command for the pump head for which you replaced the pistons (→ page 103).

If you replaced the entire pump head assembly, perform also the **SealChanged**, **CheckValveServiceDone**, and **SupportRingChanged** commands.

7.5.3 Replacing the Piston Seals

The seals prevent solvent from leaking into the rear seal wash system or into the pump. This may cause unstable flow rates and baseline noise.

Each piston has two piston seals: One main piston seal in the front part of the pump head (→ Fig. 37, no. 7, page 143 and/or Fig. 38, no. 7, page 147) and one piston seal in the plate of the rear seal wash system (→ Fig. 37 and/or Fig. 38, no. 3).

The replacement procedure for the main piston seals in the pump head consists of

1. Removing the pump head and pistons (→ page 150)
2. Disassembling the pump head and removing the pistons seals (→ page 156)
3. Cleaning the pistons (→ page 157)
4. Reassembling the pump head (→ page 158)
5. Installing the pistons and pump head (→ page 152)
6. After you have replaced the piston seals, observe the recommendations on page 161.

If you want to replace the piston seals in the plate of the rear seal wash system, follow the steps on page 162.

i **Tips:** Except for the SDN pumps, the pumps are shipped with reversed phase (RP) seals as main piston seals.

Keep in mind that using chloroform, trichlorobenzene, methylene chloride, tetrahydrofuran, or toluene as solvents chemically damages the UHMW-PE seals. Chemical reactions may also occur when using tetrachloromethane, diethyl ether, di-isopropyl ether, ketones, toluene, methylcyclohexane, and monochlorobenzene. If you use these solvents, contact the Thermo Fisher Scientific sales organization for Dionex HPLC Products.

The SDN pumps are shipped with normal phase piston seals (NP) as main piston seals. For SD and BX pumps, normal phase piston seals are available as an option (→ page 221). Depending on the application, the abrasion may be slightly increased. Therefore, depending on the pump type, check the permeability of the static mixer or inline filter at regular intervals.

7.5.3.1 Disassembling the Pump Head and Removing the Piston Seals

1. To remove the pump head and pistons, follow the steps in section 7.5.2.1 (→ page 150).

i Tip: Never disassemble the pump head with bare hands. Put on a pair of clean room gloves to prevent contamination on the pump parts. Even minute particles may cause damage to the system and result in poor pump performance.

2. Remove the plate and also the sheet of the rear seal wash system if applicable.

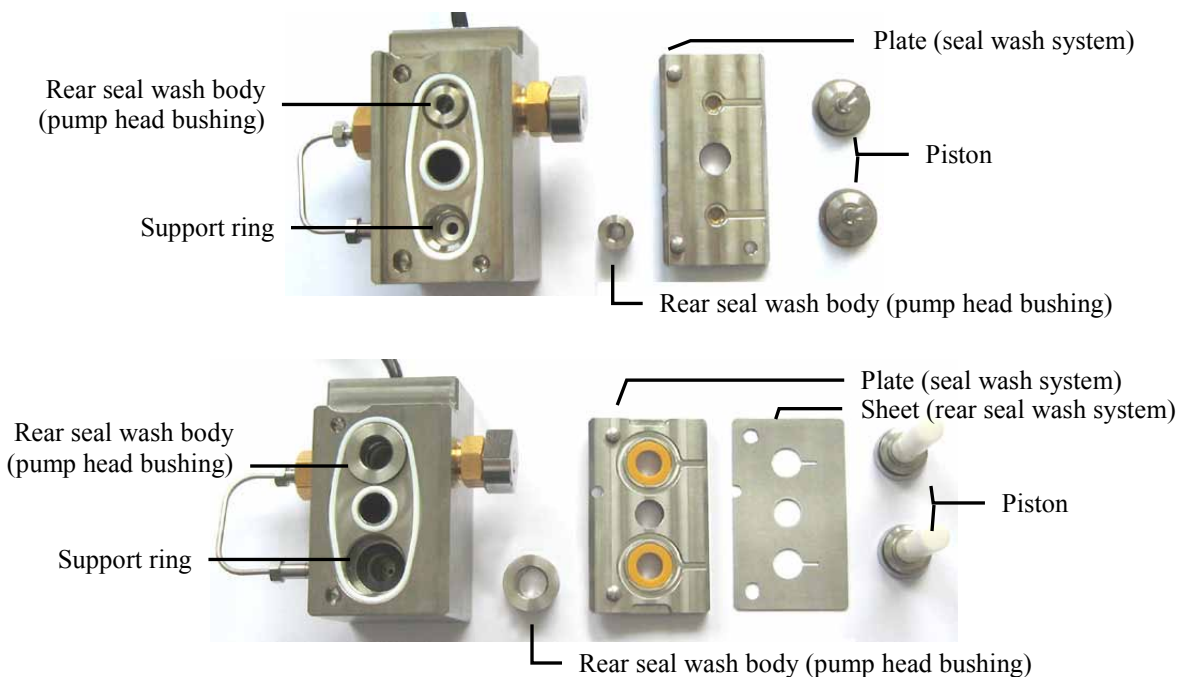

Fig. 44: Pump head, removed
(top: all pumps except HPG-3200BX; bottom: HPG-3200BX)

3. Remove the rear seal wash body (pump head bushing) from the pump head.
4. First, remove the support ring.
Tap the pump head on a surface to make the support ring drop out. If this does not remove the support ring, push the seal *insertion* tool into the pump head and remove the tool. The support ring is removed together with the tool.

i Tip: Do *not* use the **seal removal tool** for the support ring as the ring can be removed from the tool only with difficulties.

5. Remove the piston seal from the pump head.
Push the *seal removal tool* into the pump head as far as it goes in.



Fig. 45: Piston seal removal and insertion tool

6. Remove the tool from the pump head. The piston seal is removed together with the tool. The piston seal will be destroyed and *cannot* be reused.

7.5.3.2 Cleaning the Pistons

Cleaning the pistons is required only if you reinstall the pistons you removed. Verify that the pistons are clean and free of damage by using a light.

Only sapphire piston: Hold the rear side of the piston into the light. Dirt particles will be enlarged by the refraction of the light.

- i** **Tip:** Even if the piston seems to be clean, consider performing the fingernail test in addition. Hold the piston and carefully move your fingernail over the surface. After performing this test, you have to clean the piston again.

The piston is clean when the surface is completely smooth (no inconsistent or rough areas).

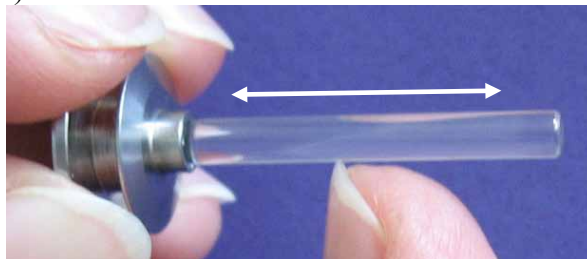

Fig. 46: Fingernail test (here on the sapphire piston)

1. Carefully rinse the piston (preferably with isopropanol), and then rub it several times with a dry, lint-free tissue.
2. Consider repeating the fingernail test.
3. Inspect the piston for signs of damage. If no damage is visible, reinstall the piston. If the piston is scratched or scored, install a new piston.

7.5.3.3 Installing the Piston Seals and Reassembling the Pump Head

Description	Part No.
Main piston seal (→ no. 7, Fig. 37, page 143 and/or Fig. 38, page 147) RS pumps (Reversed Phase) SD pumps (Reversed Phase) SDN pumps (Normal Phase) BM pumps (Reversed Phase) BX pumps (Reversed Phase)	6266.0305 6040.0304 6040.0306 Included in 6025.2012 Included in 6040.9010
Support ring (→ Fig. 37 or Fig. 38, no. 6) for RS and SD pumps BM pumps BX pumps	6040.0012 Included in 6025.2012 Included in 6040.9010
Tip: For SD and BX pumps, normal phase piston seals are available as an option (→ page 221).	

i **Tip:** Never reassemble the pump head with bare hands. Put on a pair of clean room gloves to prevent contamination on the pump parts. Even minute particles may cause damage to the system and result in poor pump performance.

1. *Depends on the pump type*

RS and SD pumps

With these pumps, the support ring is *not* a wear part. Thus, you need not replace the support ring when you replace the piston seal. Before reinstalling the support ring, you should clean the support ring from the inside and outside, using isopropanol, a cleaning swab (part no. 6040.0006), and a lint-free cloth or tissue.

BM and BX pumps

With these pumps, you should always replace the support ring whenever you replace the piston seal.

- Pipette a few drops of isopropanol onto the edge in the pump head on which the piston seal will rest.
- First, slide the support ring, and then slide the piston seal onto the seal insertion tool (→ Fig. 45, page 157). Mind the correct orientation of the seal. The open side of the seal must face away from the tool.

This side faces away from the tool.

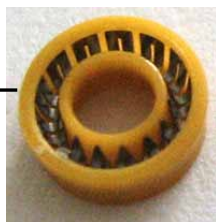

Fig. 47: Correct orientation of the piston seal (here reversed phase)

4. Push the piston seal tool into the pump head as far as it goes in.
5. Remove the tool from the pump head. The piston seal and the support ring remain in the pump head.



Fig. 48: Seal installed in the pump head

6. Insert the rear seal wash body (pump head bushing). Mind the correct orientation (→ Fig. 49). The even side faces the pump head; the opposite side faces the plate of the rear seal wash system.



Fig. 49: Orientation of the rear seal wash body

7. Place the plate of the rear seal wash system onto the pump head as shown in the picture. The channels in the plate are facing you.



Fig. 50: Pump head with plate of the rear seal wash system (left: all pumps except HPG-3200BX, right: HPG-3200BX)

8. *Only HPG-3200BX*

Place the sheet of the seal wash system onto the plate of the seal wash system as shown in the picture. Mind the correct orientation.

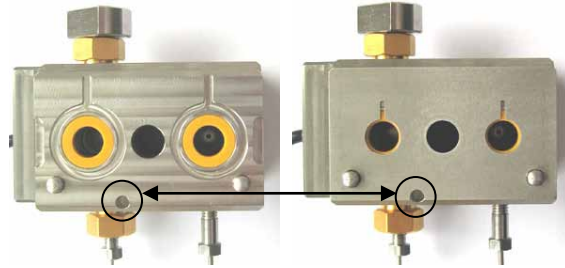

Fig. 51: Pump head with plate and sheet of the seal wash system

9. Install the pistons and pump head (→ page 152).
10. After replacing the piston seals, observe the recommendations on page 161.
11. Update the service information in Chromeleon for the pump head for which you replaced the piston seals and/or support rings. Perform the **SealChanged** command for the piston seals and the **SupportRingChanged** command for the support ring (→ page 103).

7.5.3.4 Recommended Actions after Main Piston Seal Replacement

Observe the following recommendations when you have replaced the main piston seals in the pump head:

i **Tip:** Pump performance and the seal life cycle depend directly on the actions recommended in this section. Therefore, you should perform these actions whenever you replaced the piston seals.

- Allow new piston seals to run in.
 - a) Connect drain tubing to the purge outlet nozzle.
 - b) Open the purge valve (with an ISO-3100BM, observing the precautions on page 101).
 - c) Operate the pump for 15 minutes with isopropanol at a flow rate of 1 mL/min (HPG-3200BX: 10 mL/min). Do *not* deliver in circles.
 - d) Close the purge valve.
 - e) On the pump outlet, install a flow restrictor, for example, a capillary, that can produce approximately 30 MPa (HPG-3200BX: 10 MPa) at a flow rate of 1 mL/min.
 - f) Have the pump deliver isopropanol at 1 mL/min (HPG-3200BX: 10 mL/min) for another 30 minutes.
 - g) Depending on the pump type, check the static mixer or inline filter for indications of blockage (→ page 166 or 170).
 - h) Remove the capillary from the pump outlet and connect the pump to the system.
- In rare cases, new seals may still show an increased leakage rate after several hours of operation.

If leakage is observed with new piston seals, operate the pump for at least 2 hours at 35 MPa (HPG-3200BX: 10 MPa) to run in the seals. (It does not help if you tighten the pump head screw more.)

i **Tip:** If the piston seals do not yet seal sufficiently tight, try the following: Have the pump build up high pressure (→ page 172) and hold the pressure for some minutes.

- Never run the pump dry. Damage to the pistons or the piston seals could result.

7.5.3.5 Replacing the Piston Seals in the Plate of the Seal Wash System

Description	Part No.
Piston seal in the plate of the seal wash system (→ no. 3, Fig. 37, page 143 and/or Fig. 38, page 147) RS, SD, and BM pumps BX pump	6040.0306 Included in 6040.9010

The steps depend on the pump type:

- *All pumps except HPG-3200BX*
Follow the steps further down on this page.
- *HPG-3200BX*
Follow the steps on page 163.

All pumps except HPG-3200BX

1. To remove the pump head and pistons, follow the steps in section 7.5.2.1 (→ page 150).
2. Remove the plate of the rear seal wash system.
3. Set the seal insertion tool to the side of the seal (on the low-pressure side of the plate) as shown in the picture and push the seal out of the plate.

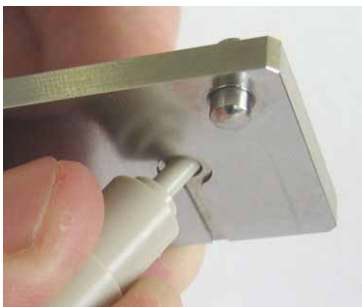

Fig. 52: Removing the seal from the plate of the seal wash system

4. Insert and push the replacement seal into the plate (high-pressure side) with your hand. To prevent contamination, put on a pair of gloves. Mind the correct orientation of the seal. The open side of the seal must face away from the plate.

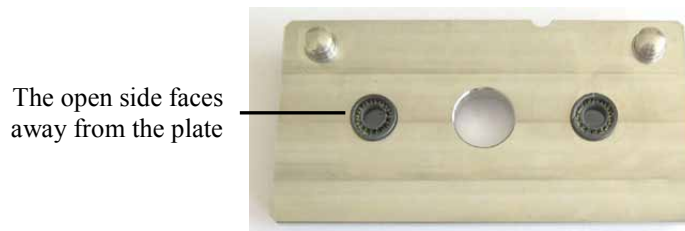

Fig. 53: Inserting the piston seal into the plate of the rear seal wash system

5. Place the plate of the rear seal wash system onto the pump head.
6. Install the pistons and pump head (→ page 152).

HPG-3200BX

1. To remove the pump head and pistons, follow the steps in section 7.5.2.1 (→ page 150).
2. Remove the sheet and plate of the seal wash system.
3. Set the seal insertion tool to the side of the seal (on the high-pressure side of the plate) and push the seal out of the plate.

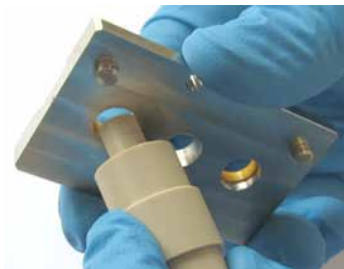

Fig. 54: Removing the seal from the plate of the seal wash system

4. Slide the new piston seal onto the seal insertion tool. Mind the correct orientation of the seal. The closed side of the seal must face the tool.
5. Insert the replacement seal into the plate (low-pressure side).



Fig. 55: Inserting the piston seal into the plate of the rear seal wash system

6. Place the plate and the sheet of the rear seal wash system onto the pump head. Mind the correct orientation.



Fig. 56: Plate and sheet of the rear seal wash system

7. Install the pistons and pump head (→ page 152).

7.6 Mixing System

RS pumps, SD pumps (except ISO-3100SD), and HPG-3200BX

The steps in the following sections refer to the replacement procedure for the mixers with which the pump is shipped (→ page 27). In addition, mixing systems with other volumes are available for some pump types. For details, see section 9 (→ page 203).

7.6.1 Replacing the Capillary Mixer and/or Static Mixer

Description	Part No.
<i>Capillary mixer, stainless steel (volume: 50 µL) for</i> HPG-3x00SD LPG-3400SD DGP-3600SD	6040.3015 6040.3026 6040.3025
<i>Capillary mixer, MP35N, Viper (volume: 50 µL) for</i> HPG-3x00RS LPG-3400RS DGP-3600RS	6042.3015 6042.3026 6042.3025
<i>Static mixer (volume: 350 µL), for</i> HPG-3x00SD, LPG-3400, and DGP-3600 (both SD and RS)	6040.5310
<i>Static mixer (volume: 150 µL), for</i> HPG-3x00RS	6040.5110
<i>Static mixer (volume: 750 µL), for</i> HPG-3200BX	6040.5750

1. When replacing a mixer, observe the following:
 - ◆ Mind the direction of flow through the mixer.
 - ◆ When you loosen or tighten capillaries on the static mixer, hold the mixer with the open-end wrench. This prevents the mixer from turning in the mounting bracket. An appropriate open-end wrench is provided in the accessories kit of the pump.
 - ◆ Observe the information about the different fitting connections on page 55.
2. Disconnect the capillary on the outlet of the static mixer.

3. Disconnect the capillary mixer on the purge unit.

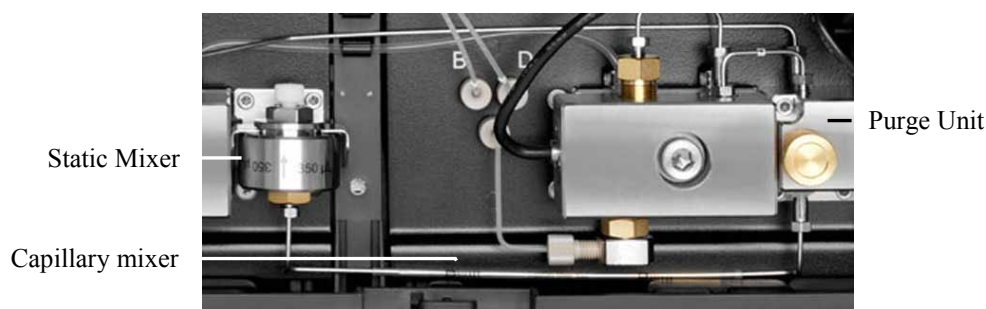

Fig. 57: Capillary mixer (here in an HPG-3400SD)

4. Remove the static mixer from the mounting bracket by pulling the mixer toward you.
5. Remove the assembly of static mixer and capillary mixer from the pump.
6. Disconnect the capillary mixer from the static mixer.
7. Connect the (new) capillary mixer to the (new) static mixer.
8. Insert the assembly of static mixer and capillary mixer into the pump.
9. Insert the static mixer into the mounting bracket.
10. Connect the capillary mixer to the purge unit.
11. Reconnect the capillary to the outlet of the static mixer.
12. *When the static mixer has been replaced*
Update the service information in Chromeleon. Perform the **MixerFritChanged** command (→ page 103).

7.6.2 Checking the Static Mixer for Permeability

Check the permeability of the static mixer at regular intervals.

i **Tip:** You can check the permeability of the static mixer also by running the **Mixer Frit Test** from Chromeleon (→ page 105).

1. Disconnect the capillary on the outlet of the static mixer.
2. Have the pump deliver water at a flow rate of 2 mL/min.
When the outlet is open, the pressure should be less than 0.5 MPa.
3. *If required*
Replace the static mixer (→ page 165).
4. Reconnect the capillary to the outlet of the static mixer.
5. Test the pump for leakage (→ page 172).

7.7 Inline Filter

7.7.1 Replacing the Inline Filter (ISO-3100)

Description	Part No.
<i>ISO-3100SD and ISO-3100BM</i> Inline filter (volume: 150 µL)	6040.5110
<i>ISO-3100SD</i> Capillary from purge unit to inline filter	6040.3024
<i>ISO-3100BM</i> Capillary from pulse damper to inline filter	Included in 6042.3002

1. Disconnect the capillary on the filter inlet and filter outlet.
When you loosen or tighten capillaries on the inline filter, hold the filter with an open-end wrench to prevent the filter from turning in the mounting bracket. (Appropriate open-end wrenches are provided in the accessories kit of the pump.)



Fig. 58: Inline filter

2. Remove the inline filter from the mounting bracket by pulling the filter toward you.
3. Insert the replacement inline filter into the bracket and reconnect the capillaries to the filter inlet and outlet.
4. Update the service information in Chromeleon. Perform the **MixerFritChanged** command (→ page 103).
5. In Chromeleon, verify that the **StaticMixer** property is set to **150 µL**. If the property is not set to the correct value, the leak tests (→ page 105) may not provide reliable results.

7.7.2 Inline Filter (LPG-3400BM, DGP-3600BM)

7.7.2.1 Replacing the Inline Filter

Description	Part No.
Inline filter for LPG-3400BM and DGP-3600BM (volume: 10 μ L)	6042.5014
Capillary from purge unit to inline filter (LPG-3400BM, DGP-3600BM)	6042.3024
<i>Tip:</i> The capillary is included also in the capillary kit for the LPG-3400BM and DGP-3600BM (part no. 6042.3001). For information about the kit content, see section 11.3 (→ page 224 and following pages).	

1. Disconnect the capillaries on the filter inlet and outlet and remove the inline filter from the pump.

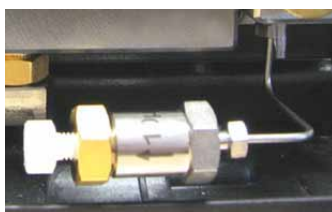

Fig. 59: Inline filter

2. Connect the capillaries to the replacement inline filter (observing the direction of flow through the filter as indicated by an arrow on the filter) and place the filter below the pump head in the pump enclosure.
3. Update the service information in Chromeleon. Perform the **MixerFritChanged** command (→ page 103).
4. In Chromeleon, verify that the **StaticMixer** property is set to **InlineFilter_10 μ L**. If the property is not set to the correct value, the leak tests (→ page 105) may not provide reliable results.

7.7.2.2 Replacing the Filter Frit in the Inline Filter

Description	Part No.
Filter frits for inline filter (LPG-3400BM and DGP-3600BM) (2 frits, titanium, porosity: 2 µm)	6268.0036

1. Remove the inline filter as described in section 7.7.2.1.
2. Open the inline filter and remove the filter frit.
3. Pipette a drop of solvent into the frit holder and insert the replacement frit. Close the filter housing. The solvent keeps the frit in the holder during closing.
4. Install the inline filter as described in section 7.7.2.1.
5. Test the pump for leakage (→ page 172).
6. Update the service information in Chromeleon. Perform the **MixerFritChanged** command (→ page 103).

7.7.3 Checking the Inline Filter for Permeability

Check the permeability of the inline filter at regular intervals.

i **Tip:** You can check the permeability of the static mixer also by running the **Mixer Frit Test** from Chromeleon (→ page 105).

1. Disconnect the capillary on the filter outlet.
2. Have the pump deliver water at a flow rate of 2 mL/min.
When the outlet is open, the pressure should be less than 0.5 MPa.
3. *If required*
 - ◆ *ISO-3100*
Replace the inline filter (→ page 167).
 - ◆ *LPG-3400BM or DGP-3600BM*
Replace the inline filter (→ page 168) or the frit in the filter (→ page 169).
4. Reconnect the capillary to the outlet of the inline filter.
5. Test the pump for leakage (→ page 172).

7.8 Replacing the Purge Valve Knob

Description	Part No.
Purge valve knob (with integrated cap seal)	6040.2035

Replace the purge valve knob if

- Leakage is observed around the valve knob when the valve is open.
 - Leakage is observed on the purge outlet when the valve is closed.
1. If necessary, purge the pump to remove harmful solvents.
 2. Set the pump flow rate to 0. Wait until the system pressure is down to zero.
 3. To remove the purge valve knob from the purge unit, turn the knob counterclockwise all the way and then pull it straight off the purge unit.
 4. Before installing the replacement purge valve knob, clean the hole in the purge unit with a cleaning swab (part no. 6040.0006).
 5. Hold the replacement valve knob carefully. You should not hold the knob by the seal end to avoid scratching the seals. These scratches will prevent proper seal and allow leakage.



Fig. 60: Purge valve knob

6. Insert the purge valve knob into the purge unit, turn the knob clockwise, and tighten fingertight. Tighten with your hand only (use no tool). Overtightening may destroy the purge valve seals.
7. Resume operation and check whether liquid leaves the purge outlet. If it does, the knob may not be tightened enough. Tighten the knob a little more.

7.9 Testing the Pump for Leakage

After you have carried out any maintenance or repair work on the fluid system, test the pump for leakage.

i **Tips:** With a DPG-3600, you have to perform the test twice, that is, separately for each of the two pumps.

You can test the pump for leakage also with the diagnostic functions in Chromeleon (→ page 105).

1. Depending on the pump type
 - ◆ *All pumps except ISO-3100BM*
Close the pump outlet with a fitting plug. Appropriate fitting plugs are provided in the accessories kit of the pump.
 - ◆ *Only ISO-3100BM*
Connect the restrictor to the pump outlet and close the other end of the capillary with a fitting plug. A restrictor capillary is provided in the Diagnostics Tool Kit (part no. 6040.3099). Appropriate fitting plugs are provided in the accessories kit of the pump.
2. In Chromeleon, set the upper pressure limit under **[Pump Device Name] > Pressure > UpperLimit**. For information about the [Pump Device Name], see page 45.

Pump Type	Upper Pressure Limit
RS Pumps	80 MPa
SD pumps	50 MPa
BM pumps	40 MPa
HPG-3200BX	15 MPa

3. In Chromeleon, select a flow rate of, for example, 50 µL/min (ISO-3100BM: 500 µL/min).
4. Decrease the flow as soon as the pressure builds up (see table)

Pump Type	Typical Pressure
RS Pumps	between 60 MPa and 70 MPa
SD pumps	between 20 MPa and 30 MPa
LPG-3400BM and DGP-3600BM	between 10 MPa and 20 MPa
ISO-3100BM	between 25 MPa and 30 MPa
HPG-3200BX	between 10 MPa and 13 MPa

5. Have the pump deliver some $\mu\text{L}/\text{min}$ until the following pressure has built up:

Pump Type	Pressure
RS Pumps	75 MPa
SD pumps	45 MPa
BM pumps	35 MPa
HPG-3200BX	14 MPa

6. When this pressure has been built up and when the pump delivers a flow of $1 \mu\text{L}/\text{min}$ (SDN pumps: $4 \mu\text{L}/\text{min}$; ISO-3100BM: $10 \mu\text{L}/\text{min}$), the pressure should increase or remain constant at least. If it does not, this indicates possible leakage.
7. Find and eliminate the cause for the leak, and then perform the test described under this list. Possible sources are:

- ◆ *Capillary connections*
Inspect them for signs of leakage and tighten leaking connections.
- ◆ *Piston seals.*
 - ◆ Inspect the piston seals for leakage (→ page 149).
 - ◆ Replace the piston seals (→ page 155).
 - ◆ If leakage is observed with new piston seals, operate the pump for at least 2 hours at 35 MPa (HPG-3200BX: 5 MPa) to run in the seals. (In this case, tightening the pump head screw does not help.)
- ◆ *Check valves*
 - ◆ Tighten the valve nuts (→ page 141).
 - ◆ Remove the valve cartridges (→ page 141) and clean them, for example, in an ultrasonic bath.
- ◆ *Purge Valve Knob*
Inspect the purge valve knob and purge unit for indications of leakage.

Test

- a) Pressure up the pump. This is the best way to identify a leaking connection.
- b) Allow 5 minutes for the pump to stabilize. This is important as the pressure drops faster during the first 5 minutes, because the seals and other components have to adjust the pressure.
- c) After the stabilization time, monitor the pressure drop.
- d) Tighten the connection a little more tight. The pressure will suddenly increase a little.
- e) Monitor if the pressure drops at the same rate as before. If the pressure drops significantly slower, the connection was leaking.

8. In Chromeleon, reset the upper pressure limit to the value used before the leak test.

i **Tip:** If leakage from a pump head is observed, check also the tubing connected to the rear seal wash system. If the seal wash tubing is not connected properly or if the tubing is crimped or kinked, the liquid may leak into the pump.

7.10 Vacuum Degasser (Rinsing the Degassing Channels)

To avoid contamination of the degasser, you should prepare fresh solvents, clean the solvent supply lines, and rinse the degassing channels at regular intervals.

Rinsing the degassing channels is especially important for the channel that degasses aqueous solvents (for reverse-phase chromatography).

Usually, it is sufficient to rinse all channels with organic solvent. (Use a fresh bottle.) When you use water and acetonitrile or methanol, it is usually sufficient to rinse the degassing channels once per week.

However, adapt the rinsing intervals to the solvents in use. In persistent cases, for example, reproducible ghost peaks in the chromatogram, follow these steps:

1. Install a backpressure capillary on the pump outlet. The capillary should be appropriate for generating a backpressure of 20 to 30 MPa.
2. Rinse the degassing channels for 1 hour with about 20% nitric acid at the flow rate normally used for your application. Use fresh HPLC grade water.
3. Rinse the degassing channels with fresh HPLC grade water until the pH value is neutral.
4. Rinse the degassing channels for two hours with fresh acetonitrile at the flow rate normally used for your application.
5. Prepare fresh solvents for your application (using new bottles) and connect them to the degassing channels.
6. Install new filter frits in the solvent supply line filters.
7. Uninstall the backpressure capillary and reconnect the system as required by your application.
8. Equilibrate the system (→ page 69).

7.11 Replacing the Main Power Fuses

STOP Warning: Turn off the pump. Disconnect the power cord from its source.

STOP Avertissement: Avant de remplacer les fusibles, arrêtez la pompe. Assurez-vous de bien débrancher le cordon d'alimentation de la source secteur.

1. Remove the fuse cartridge, by using a small screwdriver.

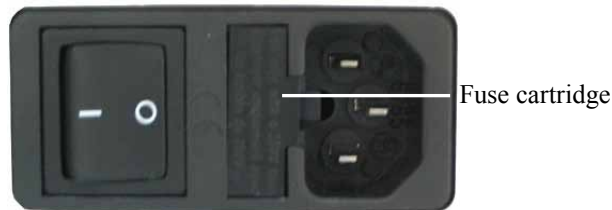

Fig. 61: Fuse cartridge

2. Replace the fuses.

STOP Warning: Always install two fuses. Use only the fuses indicated in the following table.

STOP Avertissement: Installez toujours deux nouveaux fusibles. Utilisez uniquement les fusibles indiqués ci-dessous.

Description	Part No.
Fuse, 2A, slow-blow (5 x 20 mm)	Included in the Fuses Kit, part no. 6030.9003 For information about the kit, see section 11.3 (→ page 224).

3. Reinstall the fuse cartridge.
4. Reconnect the power cord to its source. Turn on the power to the pump.

7.12 Updating the Pump Firmware

The pump is shipped with the most recent firmware version. The pump firmware is also included in Chromeleon.

To check which firmware version is installed in the pump and which version is included in Chromeleon:

- **Firmware version installed in the pump**
Turn on the pump by pressing the power switch on the rear of the pump. General information about the pump appears on the pump display, including the firmware version.
 - On the pump display, select the **Diagnostics** menu (→ page 86) and select **Firmware version**.
- **Firmware version in Chromeleon**
 - In the **Server Configuration** program, open the configuration pages for the pump (→ page 51). On the **General** page, the firmware version is displayed (→ page 43).
 - In the Windows Explorer, locate the IQReport.log file in the IQ folder of your Chromeleon installation. In the file, search for Pump3x00RS.hex (also for SD, BM, and BX pumps).

 **Tip:** When updating the pump firmware from Chromeleon, this information will also be provided during the download (see further down in this section).

Whenever a new firmware version is released for the pump, the new version will be provided with the next Chromeleon Service Release and described in the release notes.

The new firmware will *not* be downloaded automatically to the pump when you install a Chromeleon Service Release. To update the firmware, follow these steps:

 **Important:** To ensure that the download is successful, make sure that the communication between the pump and Chromeleon is *not* interrupted during the download and that you do *not* turn off the pump.

 **Important:** Au cours du téléchargement, assurez-vous que la communication entre la pompe et Chromeleon n'est pas interrompue et n'arrêtez pas l'instrument. Ceci peut entraîner des dysfonctionnements de la pompe.

1. Before you begin, verify that
 - ◆ The pump is connected in Chromeleon.
 - ◆ The Chromeleon server is in *running idle* mode. All processes on the Chromeleon server PC and in Chromeleon have been stopped.
 - ◆ The pump is unpressurized (for example, the purge valve is open) and the flow is turned off.
2. Start the **Server Configuration** program (→ page 42).

3. Right-click the pump in the timebase and click **Properties** on the menu.
4. On the **General** page (→ page 43), the firmware version provided by Chromeleon for the pump is displayed in the **Firmware** box. If more than one firmware version is available for the pump in Chromeleon, select the version you wish to transfer from the **Firmware** list.
5. Click **Download**. A message displays the firmware version that is currently installed in the pump and the version that will be downloaded from Chromeleon.

 **Tip:** If the pump comes with a newer firmware than the version included in Chromeleon, do *not* downgrade the firmware. Older firmware may be incompatible with new hardware revisions.

6. Click **Yes** to start the download. (Click No to cancel the action.)

The download may take several minutes. The download is complete when Firmware download completed successfully appears in the Messages Server window in the Chromeleon Server Configuration program. The message appears also in the Chromeleon Audit Trail.

Immediately after the new firmware has been downloaded from Chromeleon to the pump, the pump performs a reset. For about 15 seconds, the internal boot loader is updated. Do *not* turn off the pump while the boot loader is updating.

If the download from Chromeleon is not successful, the related messages appear in the Audit Trail. In this case, turn the pump off and on again. Repeat the download as described above. If the download fails again, contact Thermo Fisher Scientific Service for Dionex HPLC Products.

8 Pump-Specific Information

The sections listed in the table provide a short overview of the interior components and liquid flow path through the pump.

For the ...	Find information about the ...	On page ...
ISO-3100SD	Interior components	180
	Liquid flow path	181
	Operating principle (schematics)	182
ISO-3100BM	Interior components	183
	Liquid flow path	184
	Operating principle (schematics)	185
LPG-3400	Interior components	186
	Liquid flow path	187
	Operating principle (schematics)	189
DGP-3600	Interior components	190
	Liquid flow path	191
	Operating principle (schematics)	193
HPG-3200	Interior components	194
	Liquid flow path	195
	Operating principle (schematics)	197
HPG-3400	Interior components	198
	Liquid flow path	199
	Possible gradient compositions	200
	Operating principle (schematics)	201

8.1 ISO-3100

8.1.1 ISO-3100SD

8.1.1.1 Interior Components

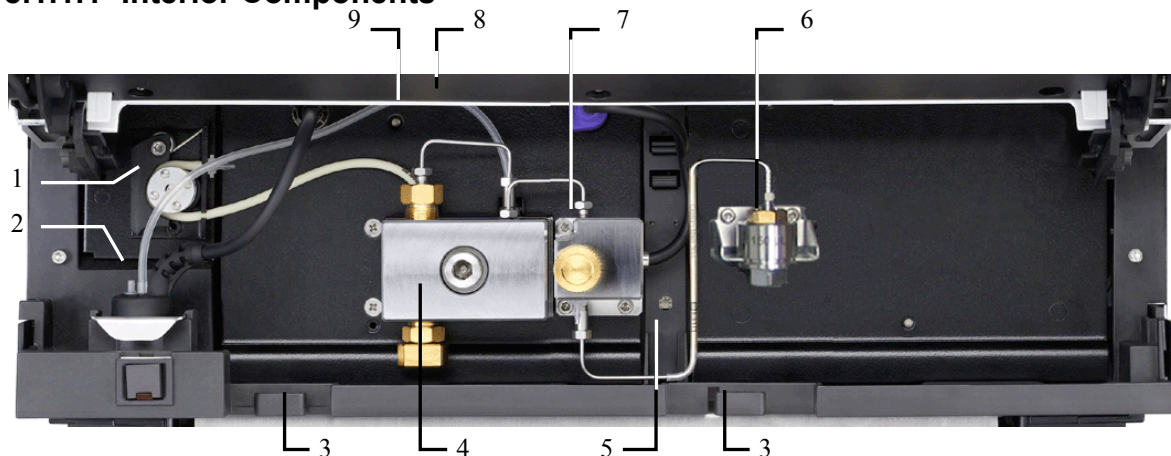

Fig. 62: Interior components (ISO-3100SD)

No.	Description
1	Peristaltic pump
2	Detector of the rear seal wash system
3	Capillary guides
4	Pump head with working cylinder and equilibration cylinder
5	Leak sensor
6	Inline filter (→ page 167)
7	Purge unit with purge valve and pressure transducer for the system pressure
8	Pump lights (here hidden by the front panel door)
9	Pump block status LED (→ page 116)

8.1.1.2 Flow Path

The picture illustrates the liquid flow path through the pump.

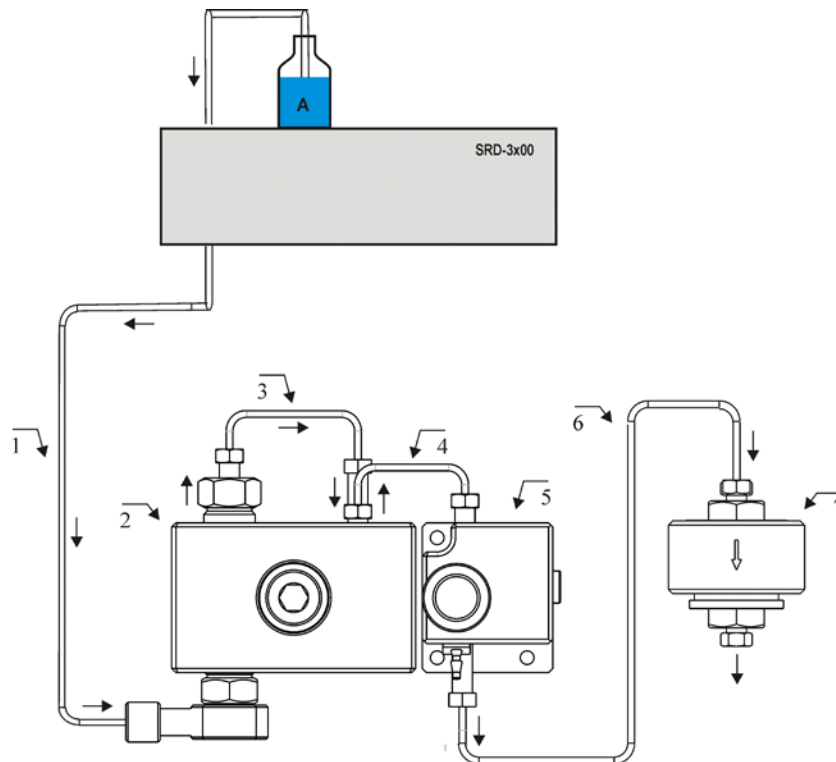

Fig. 63: Flow path through the ISO-3100SD

No.	Description	Part No.
	SRD-3x00 Solvent Rack with analytical vacuum degasser	→ page 18
1	Solvent supply line from analytical degasser to pump head	6030.2546
2	Pump head with working cylinder and equilibration cylinder (entire assembly)	→ section 7.5, page 143
3	Capillary from working cylinder to equilibration cylinder (U-tube)	Included in 6040.3001
4	Capillary from pump head to purge unit	Included in 6040.3001
5	Purge unit with purge valve and system pressure transducer	-----
6	Capillary from purge unit to inline filter	6040.3024
7	Inline filter	6040.5110

Note: Tubing and capillaries are shipped with the appropriate fitting connections.

8.1.1.3 Operating Principle (Schematics)

The picture illustrates how the pump operates.

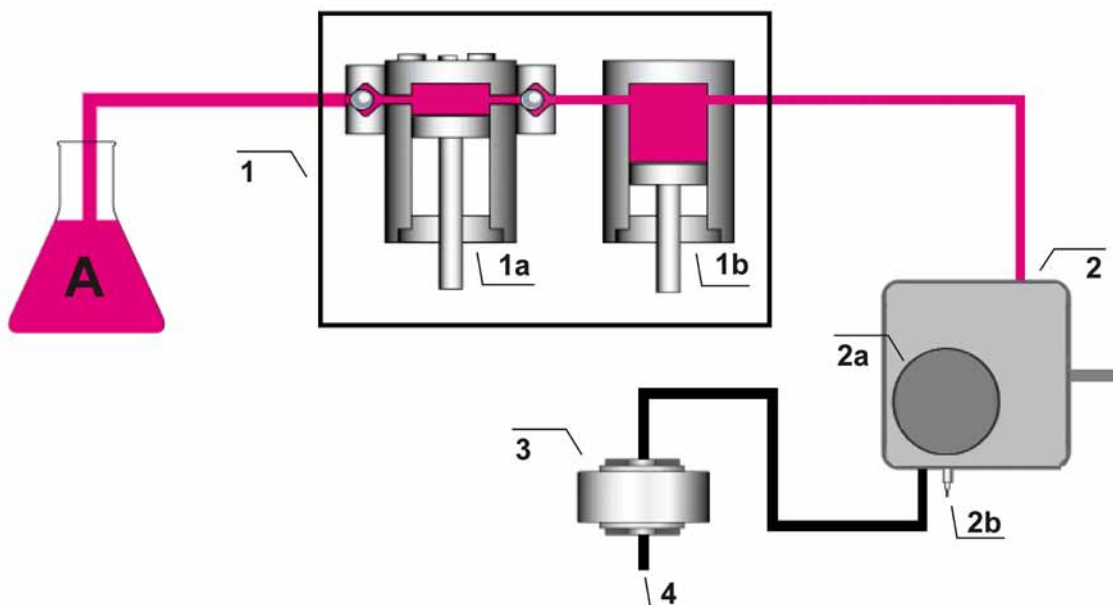

Fig. 64: Operating principle of the ISO-3100SD

No.	Element
1	Pump head with working cylinder (no. 1a) and equilibration cylinder (no. 1b)
2	Purge unit with purge valve knob (no. 2a) and outlet nozzle (no. 2b)
3	Inline filter
4	Pump outlet

For general information about the operating principle, see page 20.

8.1.2 ISO-3100BM

8.1.2.1 Interior Components

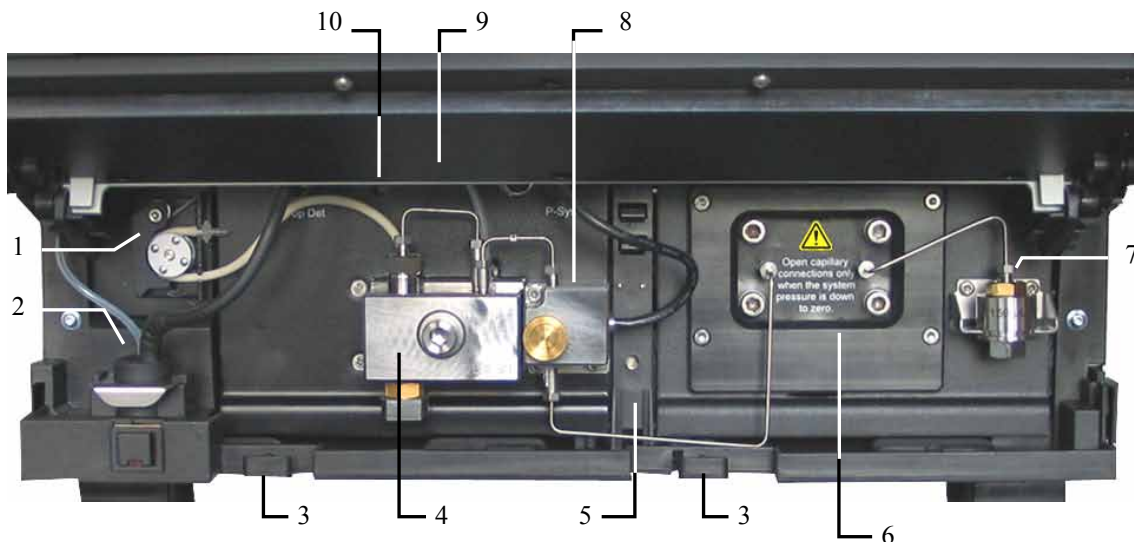

Fig. 65: Interior components (ISO-3100BM)

No.	Description
1	Peristaltic pump
2	Detector of the rear seal wash system
3	Capillary guides
4	Pump head with working cylinder and equilibration cylinder
5	Leak sensor
6	Pulse damper
7	Inline filter (→ page 167)
8	Purge unit with purge valve and pressure transducer for the system pressure
9	Pump lights (here hidden by the front panel door)
10	Pump block status LED (→ page 116)

8.1.2.2 Flow Path

The picture illustrates the liquid flow path through the pump.

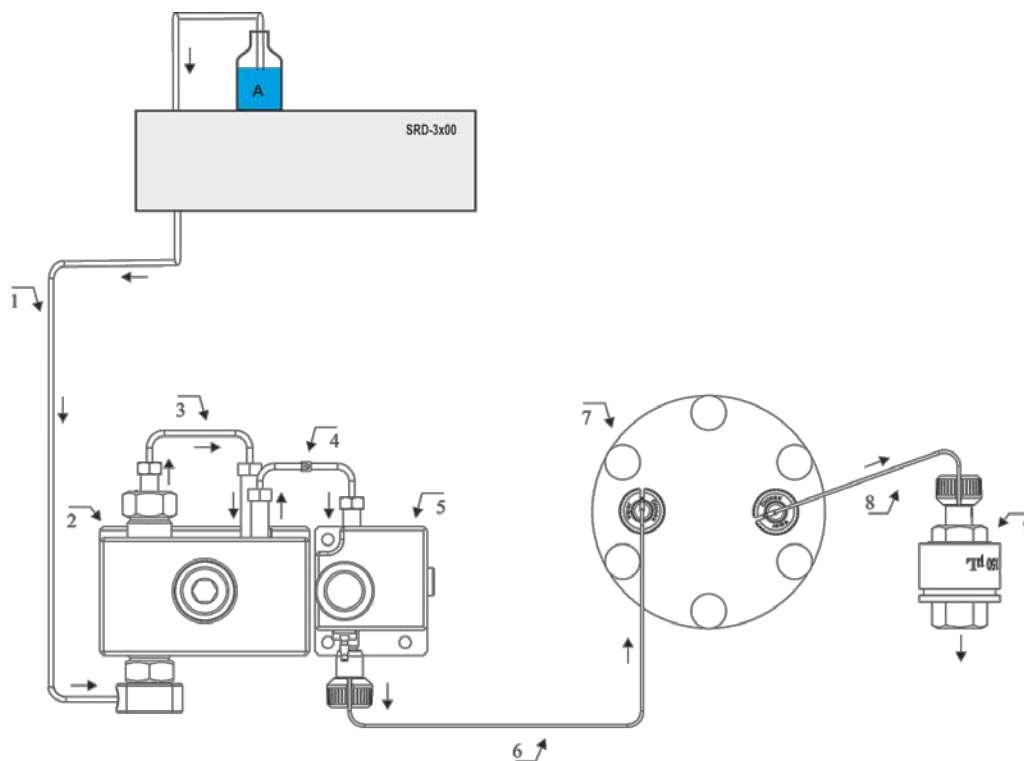

Fig. 66: Flow path through the ISO-3100BM

No.	Description	Part No.
	SRD-3x00 Solvent Rack with analytical vacuum degasser (optional)	→ page 18
1	Solvent supply line from analytical degasser to pump head —or— Solvent supply line from solvent reservoir to pump head	6030.2546 6030.2548
2	Pump head with working cylinder and equilibration cylinder (entire assembly)	→ section 7.5, page 143
3	Capillary from working cylinder to equilibration cylinder (U-tube)	Included in 6042.3002
4	Capillary from pump head to purge unit	Included in 6042.3002
5	Purge unit with purge valve and system pressure transducer	-----
6	Capillary from purge unit to pulse damper	Included in 6042.3002
7	Pulse damper	-----
8	Capillary from pulse damper to inline filter	Included in 6042.3002
9	Inline filter	6040.5110

Note: Tubing and capillaries are shipped with the appropriate fitting connections.

8.1.3 Operating Principle (Schematics)

The picture illustrates how the pump operates.

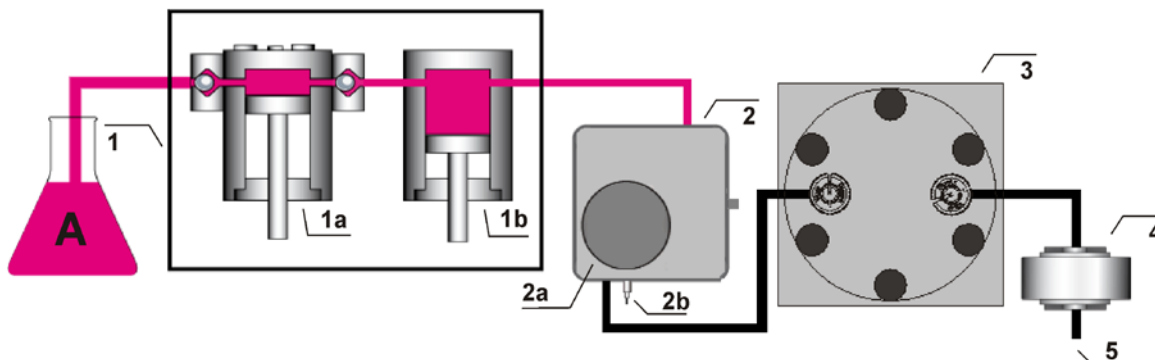

Fig. 67: Operating principle of the ISO-3100BM

No.	Element
1	Pump head with working cylinder (no. 1a) and equilibration cylinder (no. 1b)
2	Purge unit with purge valve knob (no. 2a) and outlet nozzle (no. 2b)
3	Pulse damper
4	Inline filter
5	Pump outlet

For general information about the operating principle, see page 20.

8.2 LPG-3400

8.2.1 Interior Components

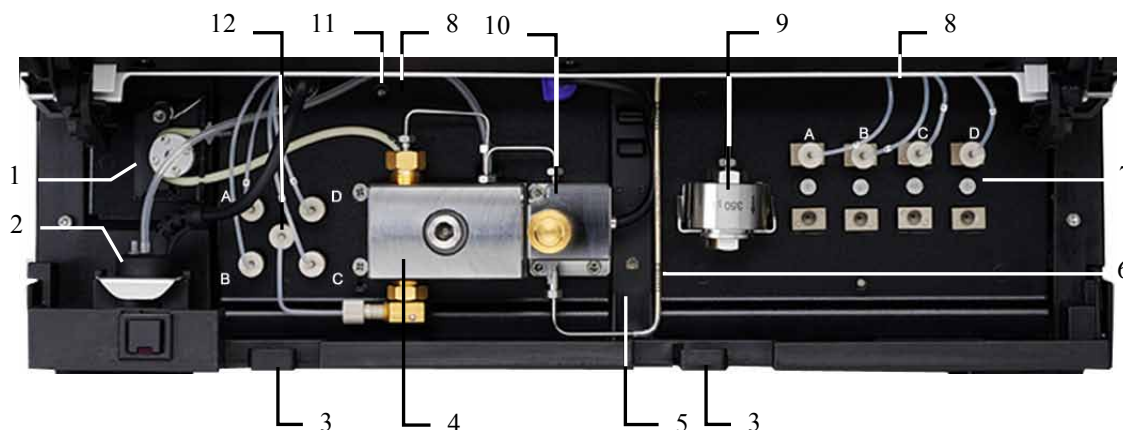

Fig. 68: Interior components of a LPG-3400 (here LPG-3400SD)

Instead of the two-step mixing system, LPG-3400BM pumps have an inline filter, which is located below the pump head.

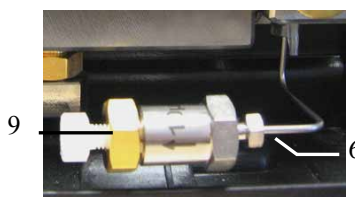

Fig. 69: Inline filter (LPG-3400BM)

No.	Description
1	Peristaltic pump
2	Detector of the rear seal wash system
3	Capillary guides
4	Pump head with working cylinder and equilibration cylinder
5	Leak sensor
6	LPG-3400SD and RS: Capillary mixer (→ page 27) LPG-3400BM: Capillary from purge unit to inline filter
7	4-channel vacuum degasser
8	Pump lights (here hidden by the front panel door)
9	LPG-3400SD and RS: Static mixer (→ page 27) LPG-3400BM: Inline filter
10	Purge unit with purge valve and pressure transducer for the system pressure
11	Pump block status LED (→ page 116)
12	4-channel proportioning valve

8.2.2 Flow Path

The picture illustrates the liquid flow path through the pump.

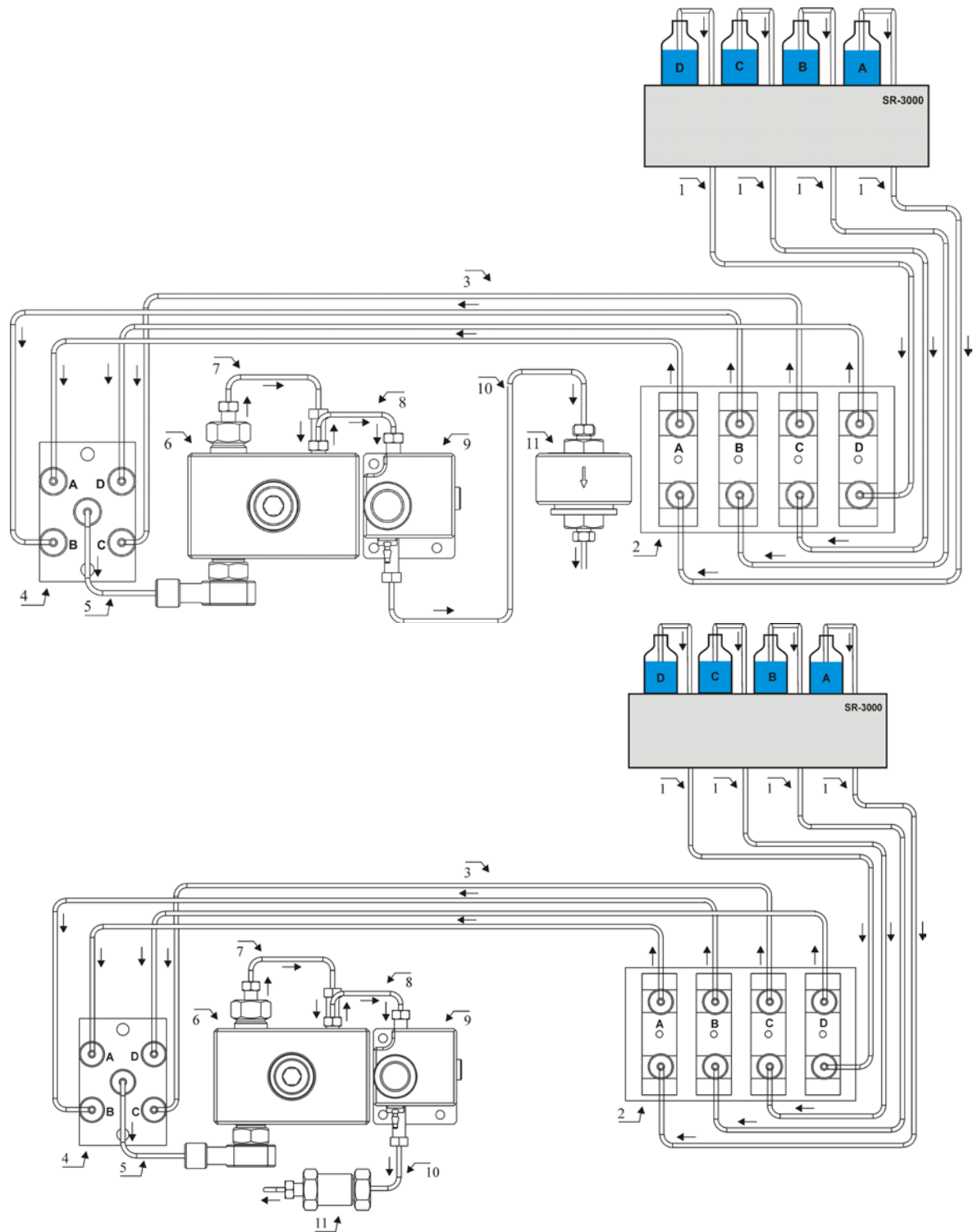

Fig. 70: Flow path through a LPG-3400 (top: LPG-3400SD/RS, bottom: LPG-3400BM)

No.	Description	Part No.
	SR-3000 Solvent Rack	→ page 18
1	Solvent supply lines to degasser (4 lines)	6040.2049
2	Analytical 4-channel vacuum degasser <i>Note:</i> You are free to choose the direction of flow through the degasser.	-----
3	Tubing from degasser to proportioning valve (4 lines)	6040.2540
4	4-channel proportioning valve	-----
5	Tubing from proportioning valve to pump head (pack of 2) LPG-3400RS and LPG-3400SD LPG-3400BM	6040.3023 6042.3023
6	Pump head with working cylinder and equilibration cylinder (entire assembly)	→ section 7.5, page 143
7	Capillary from working cylinder to equilibration cylinder (U-tube) LPG-3400RS LPG-3400SD LPG-3400BM	Included in 6040.3003 Included in 6040.3001 Included in 6042.3001
8	Capillary from pump head to purge unit LPG-3400RS LPG-3400SD LPG-3400BM	Included in 6040.3003 Included in 6040.3001 Included in 6042.3001
9	Purge unit with purge valve and system pressure transducer	-----
10	LPG-3400RS and LPG-3400SD: Capillary mixer LPG-3400BM: Capillary from purge unit to inline filter	→ page 165 6042.3024 and also Included in 6042.3001
11	LPG-3400RS and LPG-3400SD: Static mixer LPG-3400BM: Inline filter	→ page 165 6042.5014

Note: Tubing and capillaries are shipped with the appropriate fitting connections.

8.2.3 Operating Principle (Schematics)

The picture illustrates how the pump operates.

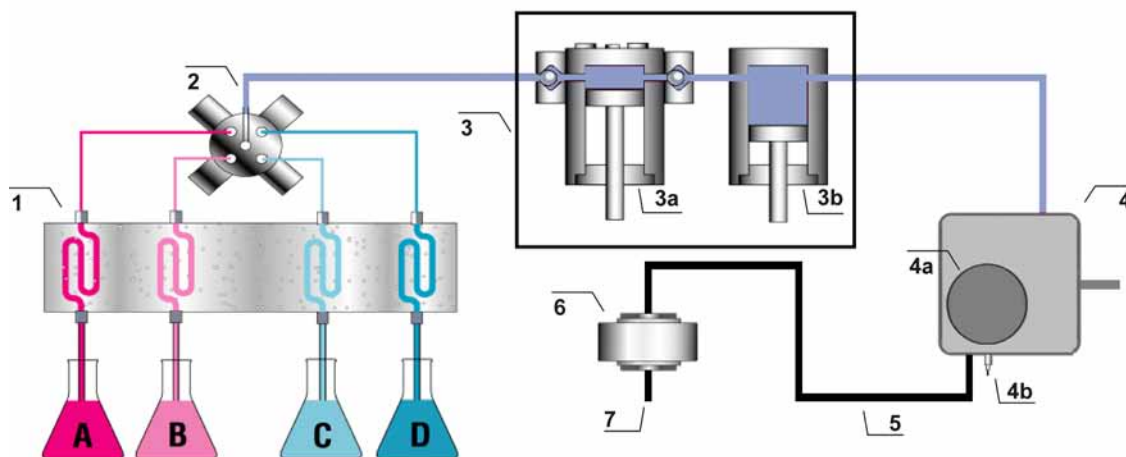

Fig. 71: Operating principle of the LPG-3400

No.	Element
1	Inbuilt vacuum degasser
2	Proportioning valve
3	Pump head with working cylinder (no. 3a) and equilibration cylinder (no. 3b)
4	Purge unit with purge valve knob (no. 4a) and outlet nozzle (no. 4b)
5 + 6	<i>LPG-3400SD and LPG-3400RS</i> Two-step mixing system with capillary mixer (no. 5) and static mixer (no. 6) <i>LPG-3400BM</i> Capillary from purge unit to inline filter (no. 5) and inline filter (no. 6)
7	Pump outlet

For general information about the operating principle, see page 20.

8.3 DGP-3600

8.3.1 Interior Components

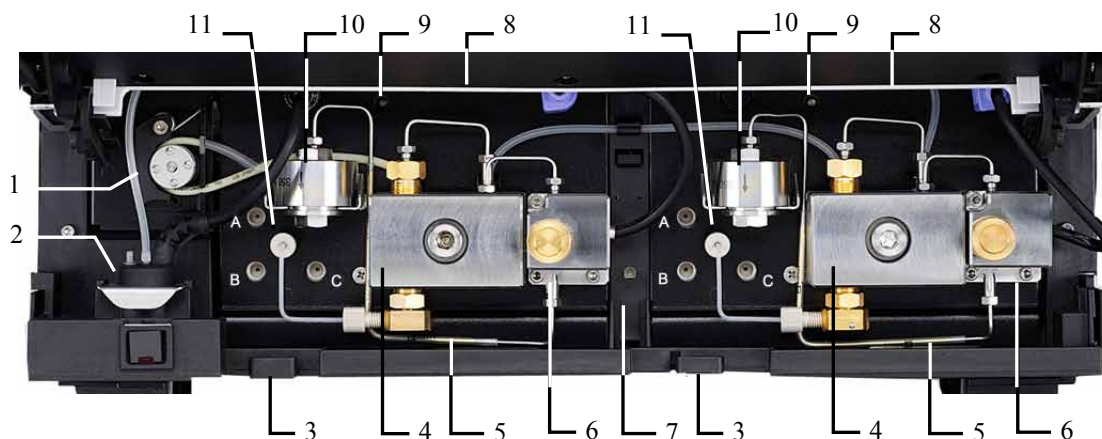

Fig. 72: Interior components DGP-3600 (here DGP-3600SD)

Instead of the two-step mixing system, DGP-3600BM pumps have an inline filter, which is located below the pump head.

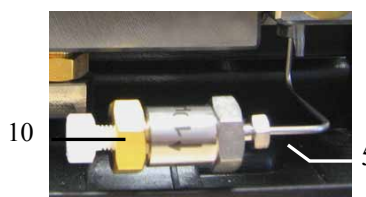

Fig. 73: Inline filter (DGP-3600BM)

No.	Description
1	Peristaltic pump
2	Detector of the rear seal wash system
3	Capillary guides
4	Pump head with working cylinder and equilibration cylinder
5	DGP-3600SD and RS: Capillary mixer (→ page 27) DGP-3600BM: Capillary from purge unit to inline filter
6	Purge unit with purge valve and pressure transducer for the system pressure
7	Leak sensor
8	Pump lights (here hidden by the front panel door)
9	Pump block status LED (→ page 116)
10	DGP-3600SD and RS: Static mixer (→ page 27) DGP-3600BM: Inline filter
11	3-channel proportioning valve

8.3.2 Flow Path

The picture illustrates the liquid flow path through the pump.

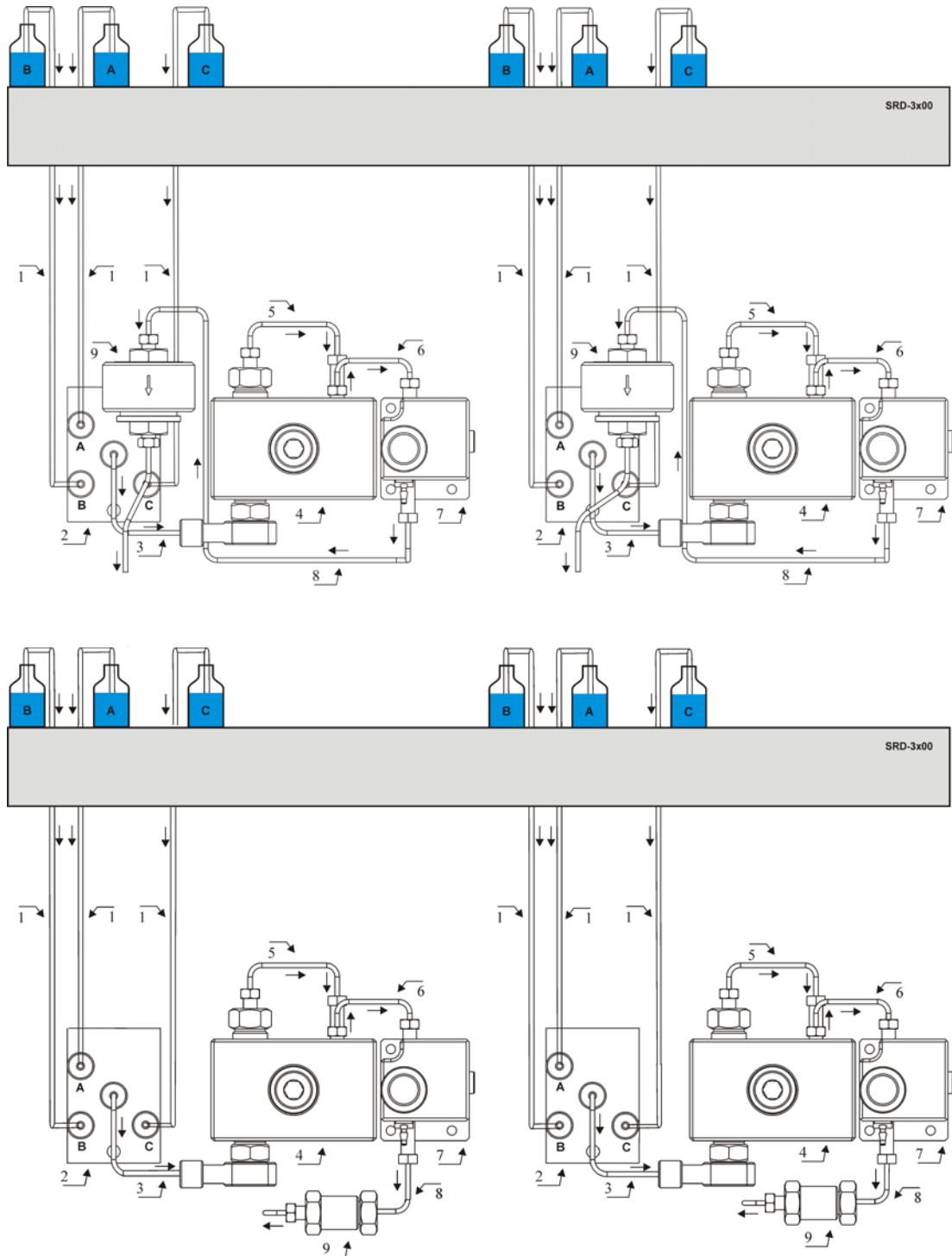

Fig. 74: Flow path through a DGP-3600 (top: DGP-3600SD/RS, bottom: DGP-3600BM)

No.	Description	Part No.
	SRD-3x00 Solvent Rack with analytical vacuum degasser	→ page 18
1	Solvent supply lines from degasser to proportioning valve (3 lines)	6030.2547
2	3-channel proportioning valve	-----
3	Tubing from proportioning valve to pump head (pack of 2) DGP-3600RS and DGP-3600SD DGP-3600BM	6040.3023 6042.3023
4	Pump head with working cylinder and equilibration cylinder (entire assembly)	→ section 7.5, page 143
5	Capillary from working cylinder to equilibration cylinder (U-tube) DGP-3600RS DGP-3600SD DGP-3600BM	Included in 6040.3003 Included in 6040.3001 Included in 6042.3001
6	Capillary from pump head to purge unit DGP-3600RS DGP-3600SD DGP-3600BM	Included in 6040.3003 Included in 6040.3001 Included in 6042.3001
7	Purge unit with purge valve and system pressure transducer	-----
8	DGP-3600RS and SD: Capillary mixer DGP-3600BM: Capillary from purge unit to inline filter	→ page 165 6042.3024 and also Included in 6042.3001
9	DGP-3600RS and SD: Static mixer DGP-3600BM: Inline filter	→ page 165 6042.5014

Note: Tubing and capillaries are shipped with the appropriate fitting connections.

8.3.3 Operating Principle (Schematics)

The picture illustrates how the pump operates.

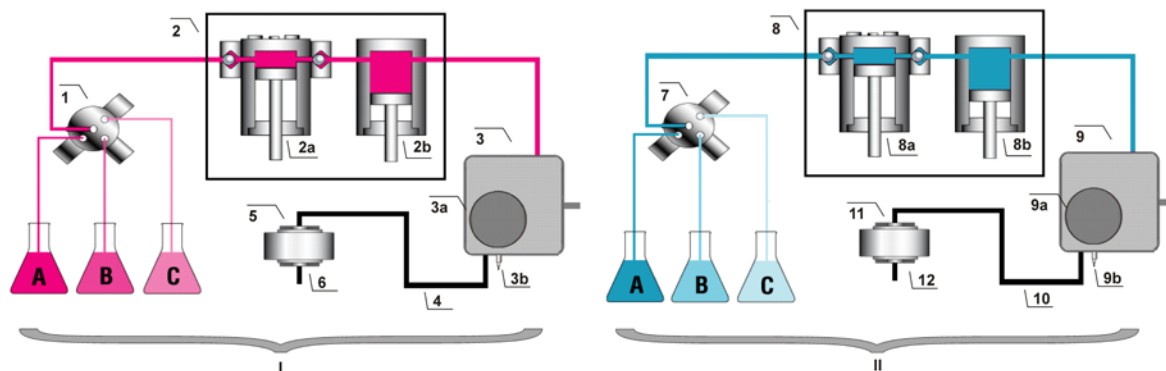

Fig. 75: Operating principle of the DGP-3600

No.	Element	No.	Element
I	Left pump	II	Right pump
1	Proportioning valve	7	Proportioning valve
2	Pump head with working cylinder (no. 2a) and equilibration cylinder (no. 2b)	8	Pump head with working cylinder (no. 8a) and equilibration cylinder (no. 8b)
3	Purge unit with purge valve knob (no. 3a) and outlet nozzle (no. 3b)	9	Purge unit with purge valve knob (no. 9a) and outlet nozzle (no. 9b)
4 + 5	<i>DGP-3600SD and DGP-3600RS</i> Two-step mixing system with capillary mixer (no. 4) and static mixer (no. 5) <i>DGP-3600BM</i> Capillary from purge unit to inline filter (no. 4) and inline filter (no. 5)	10 + 11	<i>DGP-3600SD and DGP-3600RS</i> Two-step mixing system with capillary mixer (no. 10) and static mixer (no. 11) <i>DGP-3600BM</i> Capillary from purge unit to inline filter (no. 10) and inline filter (no. 11)
6	Pump outlet	12	Pump outlet

For general information about the operating principle, see page 20.

8.4 HPG-3200

8.4.1 Interior Components

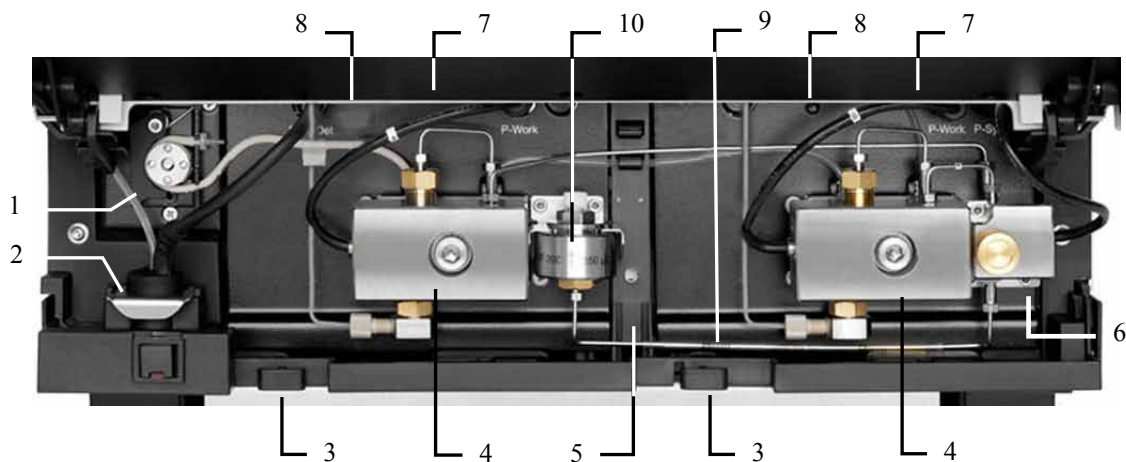

Fig. 76: Interior components in an HPG-3200 (here HPG-3200SD)

No.	Description
1	Peristaltic pump
2	Detector of the rear seal wash system
3	Capillary guides
4	Pump head with working cylinder and equilibration cylinder
5	Leak sensor
6	Purge unit with purge valve and pressure transducer for the system pressure
7	Pump lights (here hidden by the front panel door)
8	Pump block status LED (→ page 116)
9	Capillary mixer (HPG-3200SD and RS) or Capillary from purge unit to static mixer (HPG-3200BX)
10	Static mixer (→ page 27)

8.4.2 Flow Path

The picture illustrates the liquid flow path through the pump.

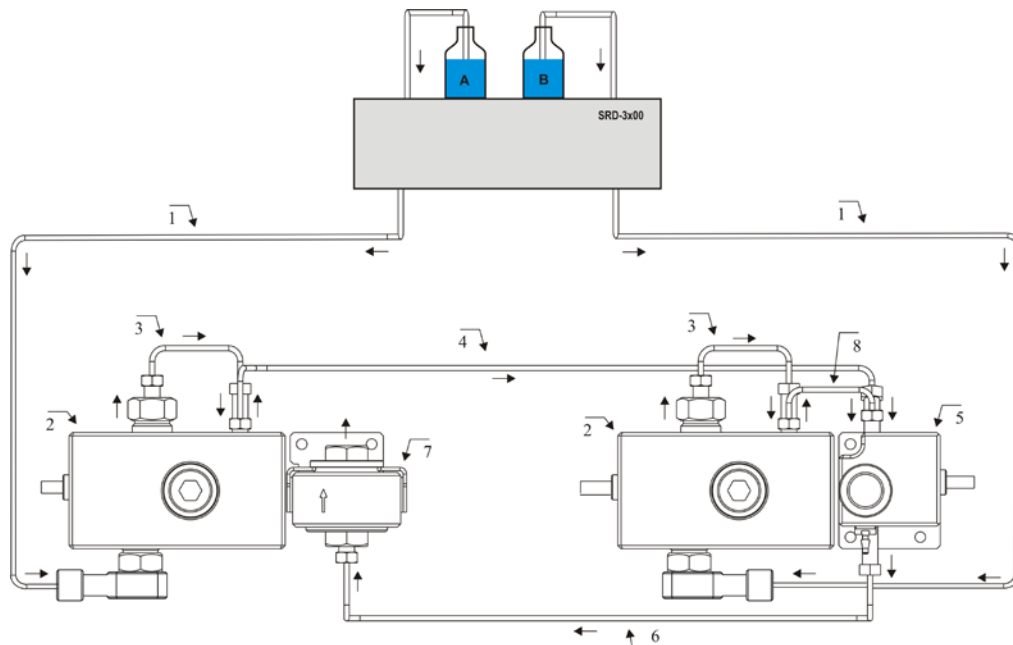

Fig. 77: Flow path through an HPG-3200 (here HPG-3200SD/RS)
The flow path through an HPG-3200BX is similar to the flow path through an HPG-3200SD/RS, but the solvent supply lines are connected directly to the pump inlet.

No.	Description	Part No.
	Only HPG-3200SD and HPG-3200RS SRD-3x00 Solvent Rack with analytical vacuum degasser	→ page 18
	Only HPG-3200BX Solvent supply lines from solvent reservoir to pump inlet	6042.2530
1	Only HPG-3200SD and HPG-3200RS Solvent supply lines from analytical degasser to pump head (pack of 2)	6035.2530
2	Pump head with working cylinder and equilibration cylinder (entire assembly)	→ section 7.5, page 143
3	Capillary from working cylinder to equilibration cylinder (U-tube) HPG-3200RS HPG-3200SD HPG-3200BX	Included in 6040.3002 Included in 6040.3000 Included in 6042.3005
4	Capillary from left pump head to purge unit HPG-3200RS HPG-3200SD HPG-3200BX	Included in 6040.3002 Included in 6040.3000 Included in 6042.3005
5	Purge unit with purge valve and system pressure transducer	-----
6	HPG-3200SD, HPG-3200RS: Capillary mixer HPG-3200BX: Capillary from purge unit to static mixer	→ page 165 Included in 6042.3005
7	Static Mixer	→ page 165

No.	Description	Part No.
8	Capillary from right pump head to purge unit HPG-3200RS HPG-3200SD HPG-3200BX	Included in 6040.3002 Included in 6040.3000 Included in 6042.3005

Note: Tubing and capillaries are shipped with the appropriate fitting connections.

8.4.3 Operating Principle (Schematics)

The picture illustrates how the pump operates.

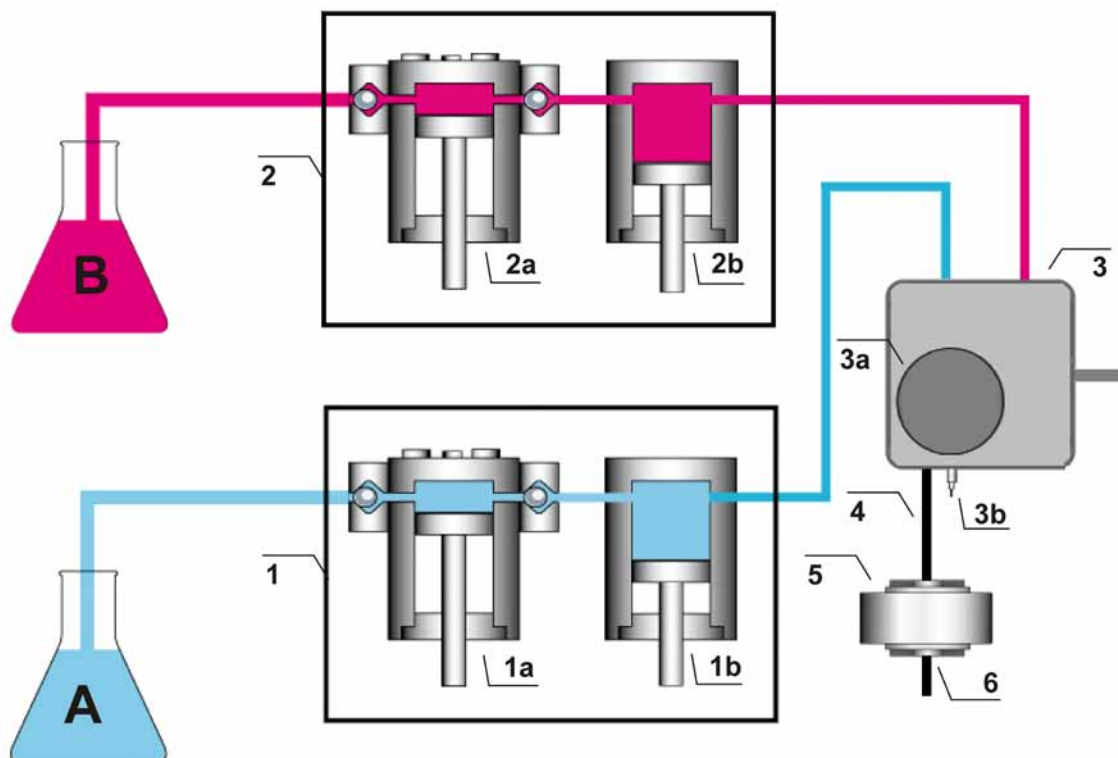

Fig. 78: Operating principle of the HPG-3200

No.	Element	No.	Element
1 1a 1b	Left pump head with working cylinder equilibration cylinder	4 + 5	<i>HPG-3200SD and HPG-3200RS:</i> Two-step mixing system with capillary mixer (no. 4) and static mixer (no. 5)
2 2a 2b	Right pump head with working cylinder equilibration cylinder		<i>HPG-3200BX:</i> Capillary from purge unit to static mixer (no. 4) Static mixer (no. 5)
3 3a 3b	Purge unit with purge valve knob outlet nozzle	6	Pump outlet

For general information about the operating principle, see page 20.

8.5 HPG-3400

8.5.1 Interior Components

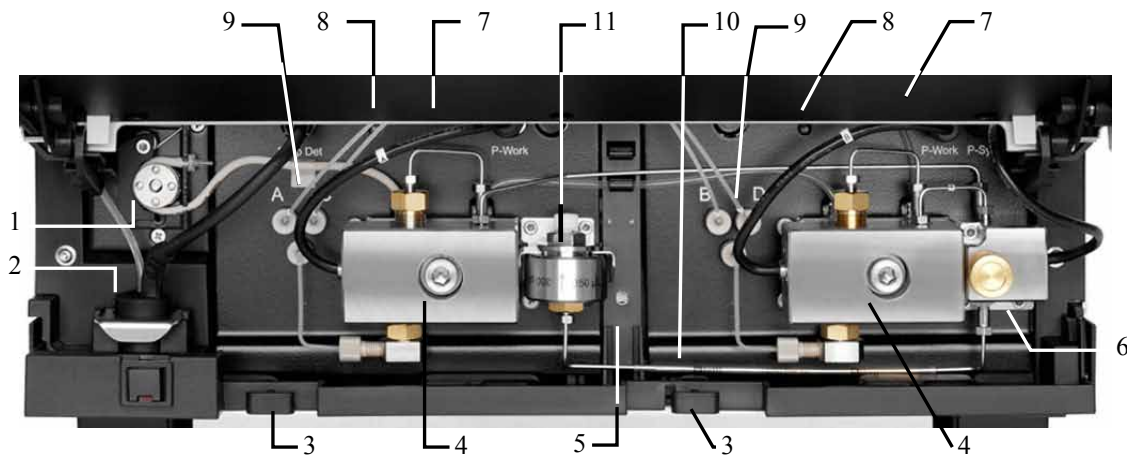

Fig. 79: Interior components in an HPG-3400 (here HPG-3400SD)

No.	Description
1	Peristaltic pump
2	Detector of the rear seal wash system
3	Capillary guides
4	Pump head with working cylinder and equilibration cylinder
5	Leak sensor
6	Purge unit with purge valve and pressure transducer for the system pressure
7	Pump lights (here hidden by the front panel door)
8	Pump block status LED (→ page 116)
9	Solvent Selector "2 from 4" (→ page 200)
10	Capillary mixer (→ page 27)
11	Static mixer (→ page 27)

8.5.2 Flow Path

The picture illustrates the liquid flow path through the pump.

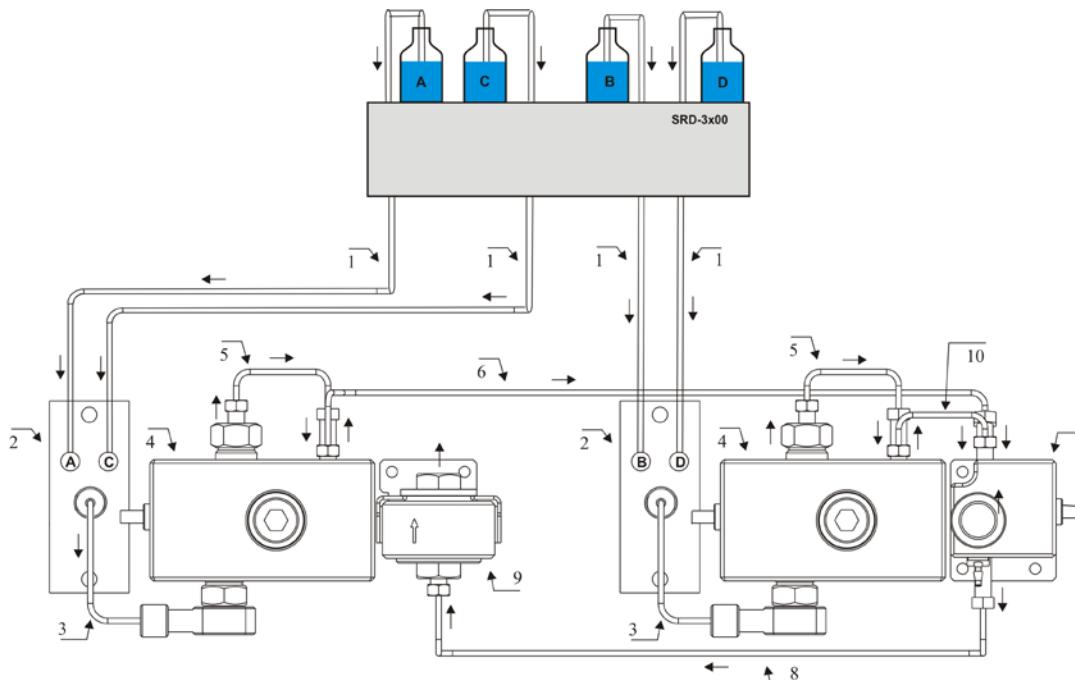

Fig. 80: Flow path through the HPG-3400

No.	Description	Part No.
	SRD-3x00 Solvent Rack with analytical vacuum degasser	→ page 18
1	Solvent supply lines from analytical degasser to solvent selectors (pack of 4)	6035.2532
2	Solvent Selector "2 from 4"	-----
3	Tubing from solvent selector to pump head (pack of 2)	6040.3017
4	Pump head with working cylinder and equilibration cylinder (entire assembly)	→ section 7.5, page 143
5	Capillary from working cylinder to equilibration cylinder (U-tube) HPG-3400RS HPG-3400SD	Included in 6040.3002 6040.3000
6	Capillary from left pump head to purge unit HPG-3400RS HPG-3400SD	Included in 6040.3002 6040.3000
7	Purge unit with purge valve and system pressure transducer	-----
8	Capillary mixer	→ page 165
9	Static Mixer	→ page 165
10	Capillary from right pump head to purge unit HPG-3400SD HPG-3400RS	Included in 6040.3002 6040.3000

Note: Tubing and capillaries are shipped with the appropriate fitting connections.

8.5.3 Possible Gradient Combinations and Operating Principle (Schematics)

The HPG-3400 includes a "2 from 4" solvent selector. Channels A and C are connected to the left pump head, while channels B and D are connected to right pump head. Thus, the solvent selector supports the following combinations of binary high-pressure gradients:

Left pump head	Right pump head
Solvent A	Solvent B
Solvent A	Solvent D
Solvent C	Solvent B
Solvent C	Solvent D

In a specific time step, each pump head delivers only one of the two channels (100%). It is not possible to specify a mixing ratio for the two channels connected to the same pump head (A and C; B and D). Before you can enter a value for B, you have to set D to 0. The same applies to all other channels.

Example 1

If you enter a portion for solvent C while solvent A is already set, the portion for solvent A is automatically reduced to 0%.

Example 2

For example, portions are set for B and C (for example, B=40%, C=60%) and you want the pump to deliver D=20%. First, set C=100% and then, set D=20%. The pump will now deliver D=20% and C=80%. The same applies to all other channels.

The picture illustrates how the pump operates.

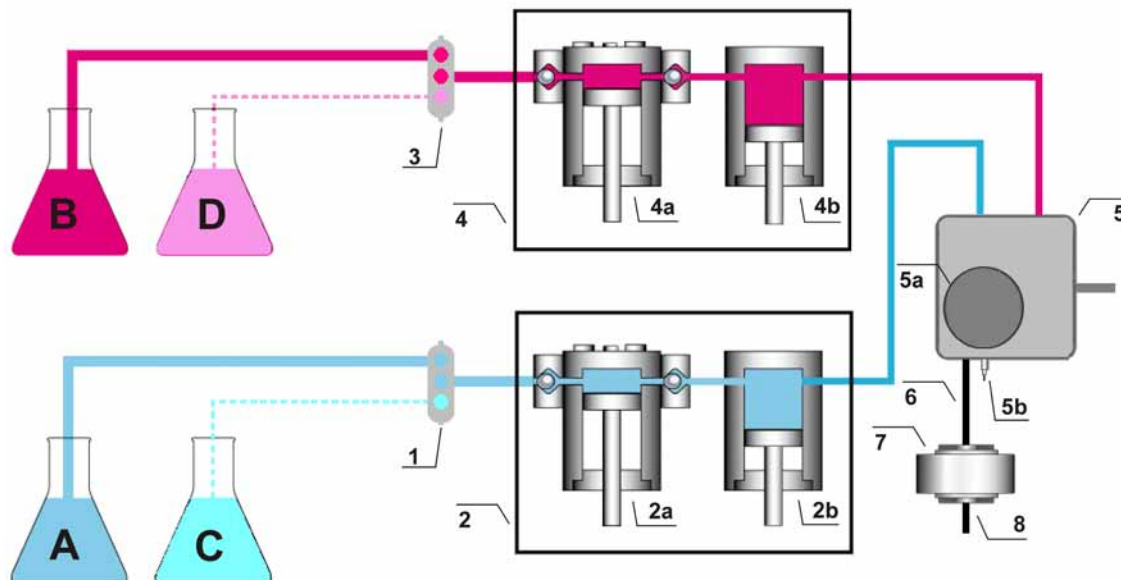

Fig. 81: Operating principle of the HPG-3400

No.	Element
1	Solvent Selector (→ page 200)
2	Left pump head with working cylinder (no. 2a) and equilibration cylinder (no. 2b)
3	Solvent Selector
4	Right pump head with working cylinder (no. 4a) and equilibration cylinder (no. 4b)
5	Purge unit with purge valve knob (no. 5a) and outlet nozzle (no. 5b)
6 + 7	Two-step mixing system with capillary mixer (no. 6) and static mixer (no. 7)
8	Pump outlet

For general information about the operating principle, see page 20.

9 Optimizing the Pump for Specific Applications

RS pumps and SD pumps (except ISO-3100SD)

In the standard configuration, the pump has been optimized for the gradient delay volume and ripple.

The gradient delay volume of an HPLC system is defined as the volume that the pump must deliver until a change in solvent composition reaches the head of the column. Reducing the gradient delay volume allows changes in the solvent composition to become effective on the column much earlier, thus having a faster effect on the elution of analytes. For information about the gradient delay volume of the different pump types, see the Technical Information section (→ page 207).

For gradient separations at low flow rates (for example, less than 100 $\mu\text{L}/\text{min}$) or very steep gradients, you can adapt the gradient delay volume to your requirements by replacing the two-step mixing system with which the pump is shipped with either a two-step mixing system with lower volume or the single-step mixing system. In both cases, the ripple will increase.

In addition, two-step mixing systems with a higher volume are available for the pump. Operating the pump with these mixing systems will reduce the ripple but increase the gradient delay volume.

For more information about the two-step mixing systems, see the next page. For information about the single-step mixing system, see page 205.

Two-step mixing systems (SpinFlow)

Two-step mixing system		
Mixing volume	including:	Part No.
100 μL	Static mixer (volume: 75 μL) Capillary mixer (volume: 25 μL) SD pumps RS pumps	6040.5100 6042.5100
200 μL	Static mixer (volume: 150 μL) Capillary mixer (volume: 50 μL)	6040.5110*
400 μL	Static mixer (volume: 350 μL) Capillary mixer (volume: 50 μL)	6040.5310*
800 μL	Static mixer (volume: 750 μL) Capillary mixer (volume: 50 μL)	6040.5750*
1550 μL	Static mixer (volume: 1500 μL) Capillary mixer (volume: 50 μL)	6040.5450*
* The part number is for all pump types. The capillary mixer is <i>not</i> included in the shipment—For details, see <i>Mixing systems with a mixing volume > 100 μL</i> under this table.		

If you want to replace the mixing system with which the pump is shipped (\rightarrow page 27) with a system listed in the table, observe the following:

- Mixing systems with a mixing volume > 100 μL*
For these mixing systems, you need *not* replace the capillary mixer. The capillary mixer is the same in both mixing systems, and thus the mixer is not included in the shipment. If you want to replace the capillary mixer nevertheless, see the part numbers on the related tables in section Replacing the Capillary Mixer and/or Static Mixer (\rightarrow page 165).
- Mixing system with a mixing volume of 100 μL*
If you want to use this mixing system, you have to replace both mixers. Therefore, both mixers are included in the shipment.

The mixer shipment includes all components required for the installation and detailed instructions.

Single-step mixing system

Single-step mixing system	Part No.
<p><i>SD pumps (except ISO-3100SD)</i></p> <p>Single-step mixing system, stainless steel, mixing volume: 35 μL, including: Capillary mixer (25 μL) and Inline filter (10 μL, porosity of the filter frit: 10 μm)</p> <p><i>The components of the kit are available also as separate parts:</i></p> <p>Capillary mixer, stainless steel (volume: 25 μL) for Inline filter, stainless steel (volume: 10 μL, porosity of the frit: 10 μm) Replacement frits for inline filter (2 frits, porosity: 10 μm)</p>	<p>6040.5000</p> <p>6040.3020 6040.5010 6268.0034</p>
<p><i>RS pumps</i></p> <p>Single-step mixing system, titanium/MP35N, mixing volume: 35 μL, including: Capillary mixer, Viper, MP35N (volume: 25 μL) and Inline filter, titanium (volume: 10 μL, porosity of the filter frit: 2 μm)</p> <p><i>The components of the kit are available also as separate parts:</i></p> <p>Capillary mixer, Viper, MP35N (volume: 25 μL) for Inline filter, titanium (volume: 10 μL, porosity of the frit: 2 μm) Replacement frits for inline filter (2 frits, porosity: 2 μm)</p>	<p>6042.5000</p> <p>6042.3020 6042.5014 6268.0036</p>

1. Remove the capillary mixer and the static mixer as described in section 7.6.1 (→ page 165).
2. Disconnect the capillary mixer on the purge unit.
3. Connect the replacement capillary mixer (25 μ L) to the purge unit.
4. Connect the free end of the capillary mixer with the inline filter and place the inline filter below the right pump head in the pump enclosure.

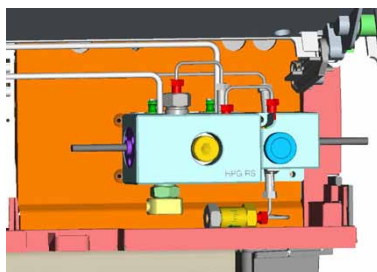

Fig. 82: Single-step mixing system with inline filter (here in an HPG-3x00)

5. Connect an appropriate capillary for the connection to the autosampler on the mixer outlet.

6. In Chromeleon, set the **StaticMixer** property to **InlineFilter_10 µL**. If the property is not set to the correct value, the leak tests (→ page 105) may not provide reliable results.

i **Tip:** Check the permeability of the frit in the inline filter at regular intervals (the procedure is similar to the steps in section 7.7.3, page 170).

To replace the filter frit, follow the steps in section 7.7.2.2 (→ page 169).

10 Technical Information

Technical information as of September 2013 - All technical specifications are subject to change without notice.

10.1 SD Pumps

Specification*	ISO-3100SD	LPG-3400SD(N)	DGP-3600SD(N)	HPG-3200SD	HPG-3400SD
Operating Principle	Serial dual-piston pump				
Compressibility compensation	Fully automated, independent of the composition of the mobile phase				
Flow rate range Recommended Settable	mL/min 0.05 - 10 0.001 - 10	mL/min 0.2 - 10 0.001 - 10		mL/min 0.1 - 10 0.001 - 10	
Flow rate accuracy	±0.1%				
Flow rate precision	< 0.05% RSD or < 0.01 min SD, whichever is greater				
Pressure range	2 - 62 MPa (290 - 9000 psi)				
Pressure ripple	Typically <1% or <0.2 MPa, whichever is greater				
Gradient formation	N.a.	Low-pressure proportioning	Dual low-pressure proportioning	High-pressure proportioning	
Proportioning accuracy	N.a.	±0.5% of fullscale**		±0.2% of fullscale	
Proportioning precision	N.a.	<0.15% SD			
Number of solvents	1	4	6 (2 x 3)	2	2 or 2 from 4
Gradient delay volume (independent of working pressure)	N.a.	Standard: 690 µL (325 - 1,840 µL with optional mixing systems)		Standard: 400 µL (35 - 1,550 µL with optional mixing systems)	
Solvent degassing	External (optional)	Built-in 4-channel degasser	External (optional)	External (optional)	
Weight	12.5 kg	13.6 kg	16.6 kg	16.3 kg	16.4 kg
Dimensions	16 x 42 x 51 cm (h x w x d)				
PC connection	All functions controllable via USB (USB 1.1 or 2.0) Integrated USB hub with three USB ports (USB 1.1 or 2.0)				
I/O Interfaces	2 digital inputs, 2 relay outputs 15-pin D-Sub port for connection of a Solvent Rack or degasser				
Safety features	Leak sensor, active rear seal wash system, excess pressure monitoring				
User input/display	LCD indicating system parameters Standby button 3 LEDs (Power, Connected, and Status) for status monitoring 4 function keys for operation during initial installation and maintenance				
GLP features	In Chromeleon: Support of automatic equipment qualification (AutoQ™ routines) and System Wellness monitoring. All system parameters are logged in the audit trail.				
Wetted parts	Stainless steel, titanium, zirconium oxide, sapphire, aluminum oxide, PEEK™, PTFE, ECTFE, FEP, UHMW polyethylene (not with SDN pumps), carbon-fibre filled PTFE (only SDN pumps), perfluoro elastomer (not with ISO-3100SD, HPG-3200SD); only LPG-3400SD: amorphous fluoropolymer (AF)				
Power requirements	100-120V, 60 Hz; 200-240V, 50 Hz; max. 150 VA; 1,3A @115V, 0,7A@230V				
Emission sound pressure level	< 70 dB(A) in 1-m-distance				
Environmental conditions	Range of use: Indoor use; temperature: 10 °C to 35 °C (50 to 95°F); air humidity: 80% relative humidity, non-condensing; overvoltage category: II; pollution degree: 2				

* Typical operating conditions for measurable specifications (SD pumps): 1 or 2 mL/min @ 8 MPa or 16 MPa

** Proportioning accuracy: Typically ± 1.0% of fullscale for combinations other than AB

10.2 RS Pumps

Specification*	LPG-3400RS	DGP-3600RS	HPG-3200RS	HPG-3400RS
Operating Principle	Serial dual-piston pump			
Compressibility compensation	Fully automated, independent of the composition of the mobile phase			
Flow rate range Recommended Settable	mL/min 0.1 - 8 0.001 - 8		mL/min 0.05 - 8 0.001 - 8	
Flow rate accuracy	±0.1%			
Flow rate precision	< 0.05% RSD or < 0.01 min SD, whichever is greater			
Pressure range	2-103 MPa (290 - 15000 psi) With a flow rate of > 5 mL/min, the pressure range decreases linearly down to 80 MPa (11,600 psi).			
Pressure ripple	Typically <1% or <0.2 MPa, whichever is greater			
Gradient formation	Low-pressure proportioning	Dual low-pressure proportioning	High-pressure proportioning	
Proportioning accuracy	±0.5% of fullscale**		±0.2% of fullscale	
Proportioning precision	<0.15% SD			
Number of solvents	4	6 (2 x 3)	2	2 or 2 from 4
Gradient delay volume (independent of working pressure)	Standard: 690 µL (325 - 1,840 µL with optional mixing systems)		Standard: 200 µL (35 - 1,550 µL with optional mixing systems)	
Solvent degassing	Built-in 4-channel degasser	External (optional)	External (optional)	
Biocompatibility	Yes			
Weight	13.6 kg	16.6 kg	16.3 kg	16.4 kg
Dimensions	16 x 42 x 51 cm (h x w x d)			
PC connection	All functions controllable via USB (USB 1.1 or 2.0) Integrated USB hub with three USB ports (USB 1.1 or 2.0)			
I/O Interfaces	2 digital inputs, 2 relay outputs, 15-pin D-Sub port for connection of a Solvent Rack or degasser			
Safety features	Leak sensor, active rear seal wash system, excess pressure monitoring			
User input/display	LCD indicating system parameters Standby button, 3 LEDs (Power, Connected, and Status) for status monitoring 4 function keys for operation during initial installation and maintenance			
GLP features	In Chromeleon: Support of automatic equipment qualification (AutoQ™ routines) and System Wellness monitoring. All system parameters are logged in the Audit Trail.			
Wetted parts	MP35N®, titanium, zirconium oxide, sapphire, aluminum oxide, PEEK™, PTFE, ECTFE, FEP, UHMW polyethylene, perfluoro elastomer (not with HPG-3200RS), only LPG-3400RS: amorphous fluoropolymer (AF)			
Power requirements	100-120V, 60 Hz; 200-240V, 50 Hz; max. 150 VA; 1,3A @115V, 0,7A@230V			
Emission sound pressure level	< 70 dB(A) in 1-m-distance			
Environmental conditions	Range of use: Indoor use; temperature: 10 °C to 35 °C (50 to 95°F); air humidity: 80% relative humidity, non-condensing; overvoltage category: II; pollution degree: 2			

* Typical operating conditions for measurable specifications (RS pumps): 1 or 2 mL/min @ 20 MPa or 40 MPa

** Proportioning accuracy: Typically ± 1.0% of fullscale for combinations other than AB

10.3 BM Pumps

Specification*	LPG-3400BM	DGP-3600BM	ISO-3100BM
Operating Principle	Serial dual-piston pump		
Compressibility compensation	Fully automated, independent of the composition of the mobile phase		
Flow rate range Recommended Settable	mL/min 0.05 - 2.5 0.001 - 2.5		
Flow rate accuracy	±0.5%		
Flow rate precision	< 0.05% RSD or < 0.01 min SD, whichever is greater		
Pressure range	2 - 50 MPa (290 - 7250 psi)		2 - 41 MPa (290 - 6000 psi)
Pressure ripple	Typically <1% or <0.2 MPa, whichever is greater		Typically <0.1% or <0.02 MPa, whichever is greater
Gradient formation	Low-pressure proportioning	Dual low-pressure proportioning	N.a.
Proportioning accuracy	±1.0% of full scale		N.a.
Proportioning precision	<0.3% SD		N.a.
Number of solvents	4	6 (2 x 3)	1
Gradient delay volume	220 µL, independent of the working pressure		N.a.
Solvent degassing	Built-in 4-channel degasser	External (optional)	External (optional)
Biocompatibility	Yes		
Weight	13.5 kg	16.5 kg	12.8 kg
Dimensions	16 x 42 x 51 cm (h x w x d)		
PC connection	All functions controllable via USB (USB 1.1 or 2.0) Integrated USB hub with three USB ports (USB 1.1 or 2.0)		
I/O Interfaces	2 digital inputs, 2 relay outputs 15-pin D-Sub port for connection of a Solvent Rack or degasser		
Safety features	Leak sensor, active rear seal wash system, excess pressure monitoring		
User input/display	LCD indicating system parameters Standby button 3 LEDs (Power, Connected, and Status) for status monitoring 4 function keys for operation during initial installation and maintenance		
GLP features	In Chromeleon: Support of automatic equipment qualification (AutoQ™ routines) and System Wellness monitoring. All system parameters are logged in the audit trail.		
Wetted parts	Titanium, zirconium oxide, sapphire, aluminum oxide, PEEK™, PTFE, ECTFE, FEP, UHMW polyethylene, perfluoro elastomer (not with ISO-3100BM), only LPG-3400BM: amorphous fluoropolymer (AF)		
Power requirements	100-120V, 60 Hz; 200-240V, 50 Hz; max. 150 VA; 1,3A @115V, 0,7A@230V		
Emission sound pressure level	< 70 dB(A) in 1-m-distance		
Environmental conditions	Range of use: Indoor use; temperature: 10 °C to 35 °C (50 to 95°F); air humidity: 80% relative humidity, non-condensing; overvoltage category: II; pollution degree: 2		

* Typical operating conditions for measurable specifications (BM pumps): 200 or 300 µL/min @ 17 MPa or 25 MPa

10.4 HPG-3200BX

Specification*	HPG-3200BX
Operating Principle	Serial dual-piston pump
Compressibility compensation	Fully automated, independent of the composition of the mobile phase
Flow rate range Recommended Settable	mL/min 0.5 - 50 0.001 - 50
Flow rate accuracy	±0.1%
Flow rate precision	< 0.05% RSD or < 0.01 min SD, whichever is greater
Pressure range	2- 16 MPa (290 - 2400 psi) With a flow rate of > 30 mL/min, the pressure range decreases linearly down to 13.5 MPa (1950 psi).
Pressure ripple	Typically <1% or <0.2 MPa, whichever is greater
Gradient formation	High-pressure proportioning
Proportioning accuracy	±0.2% of fullscale
Proportioning precision	<0.2% SD
Number of solvents	2
Gradient delay volume	800 µL, independent of the working pressure
Solvent degassing	N.a.
Biocompatibility	Yes
Weight	16.3 kg
Dimensions	16 x 42 x 51 cm (h x w x d)
PC connection	All functions controllable via USB (USB 1.1 or 2.0) Integrated USB hub with three USB ports (USB 1.1 or 2.0)
I/O Interfaces	2 digital inputs, 2 relay outputs 15-pin D-Sub port for connection of a Solvent Rack or degasser
Safety features	Leak sensor, active rear seal wash system, excess pressure monitoring
User input/display	LCD indicating system parameters Standby button 3 LEDs (Power, Connected, and Status) for status monitoring 4 function keys for operation during initial installation and maintenance
GLP features	In Chromeleon: Support of automatic equipment qualification (AutoQ™ routines) and System Wellness monitoring. All system parameters are logged in the Audit Trail.
Wetted parts	Titanium, zirconium oxide, aluminum oxide, PEEK™, PTFE, FEP, UHMW polyethylene
Power requirements	100-120V, 60 Hz; 200-240V, 50 Hz; max. 150 VA; 1,3A @115V, 0,7A@230V
Emission sound pressure level	< 70 dB(A) in 1-m-distance
Environmental conditions	Range of use: Indoor use; temperature: 10 °C to 35 °C (50 to 95°F); air humidity: 80% relative humidity, non-condensing; overvoltage category: II; pollution degree: 2

* Typical operating conditions for measurable specifications (HPG-3200BX): 5 or 10 mL/min @ 2 MPa or 5 MPa

11 Accessories, Consumables, and Spare Parts

Accessories, spare parts, and consumables for the pump are always maintained at the latest technical standard. Therefore, part numbers are subject to alteration. However, updated parts will always be compatible with the parts they replace.

11.1 Standard Accessories

The following standard accessories are shipped with the instrument (subject to change without notice). Some parts listed in the following tables are included in one of the spare part kits. For information about these kits, see section 11.3 (→ page 224).

The part number always refers to the packing unit. Unless otherwise stated, the packing unit is 1 unit. For more information, contact the Thermo Fisher Scientific sales organization for Dionex HPLC Products.

11.1.1 SD Pumps

Description	Part No.	Quantity in the kit
Accessories kit of ISO-3100SD, LPG-3400SD, DGP-3600SD		
Fuse, 2A, slow-blow (5 x 20 mm)	Included in 6030.9003	2
Components for UltiMate 3000 system drainage: Cable clips (self-adhesive) Y piece T piece Elbow Connecting tube Drain tubing Installation instructions	Included in 6040.0005	4 5 4 12 1 6m 1
Labels for solvent tubing 3.0 mm, both red and green	----	6 each
Silicone tubing (2.80 mm O.D. x 1.30 mm I.D.)	Included in 6000.0010	3 m
Retaining guide (for seal wash reservoir)	Included in 6000.0042	2
Fitting plug (stainless steel, Viper)	6040.2303	1
Union, Viper	6040.2304	1
Tubing connector (straight, for I.D. 1.0 - 2.0 mm)	Included in 6040.9502	5
Solvent supply line filter, including: Filter holder (top and bottom parts) and Filter frit (stainless steel, porosity: 10 µm)	Included in 6268.0115 Included in 6268.0110	1

Description	Part No.	Quantity in the kit
Tool kit for UltiMate 3000 RS, SD, BM pumps, and NCS-3500RS/NCP-3200RS, including: 1 open-end wrench (1/4" x 5/16") 2 open-end wrenches (11 x 13 mm) 1 hexagon wrench (size 6 mm) 1 piston seal removal and insertion tool 1 pump head tool for RS/SD pumps and 1 pump head tool for BM pumps and NCS-3500RS/NCP-3200RS (the tool is required for establishing the distance during piston installation)	6007.9304	1
Seal wash reservoir, 250 mL	Included in 2270.0026	1
Bottle cap for the seal wash reservoir	Included in 2270.0026	1
Plastic syringe (12 mL)	Included in 6000.0010	1 syringe
Chromeleon Service Release DVD	4580.0316	1
HPLC Troubleshooting Guide Poster	6040.0050	1
Viper capillary kit for UltiMate 3000 Standard System (single-stack setup), including 1 capillary (0.18 x 250 mm (I.D. x L), stainless steel, Viper) e.g., to connect the TCC-3000SD (column outlet) to a DAD-3000, MWD-3000, or VWD-3100 1 capillary (0.18 x 350 mm (I.D. x L), stainless steel, Viper) e.g., to connect the WPS-3000SL to the TCC-3000SD (column inlet) 1 capillary (0.18 x 450 mm (I.D. x L), stainless steel, Viper) e.g., to connect the pump to the WPS-3000SL	6040.2302	1
USB cable, type A to type B, high speed USB 2.0 (cable length: 1 m)	6035.9035	1
USB cable, type A to type B, high speed USB 2.0 (cable length: 5 m)	6911.0002	1

Description	Part No.	Quantity in the kit
Accessories kit of HPG-3200SD and HPG-3400SD		
Fuse, 2A, slow-blow (5 x 20 mm)	Included in 6030.9003	2
Components for UltiMate 3000 system drainage: Cable clips (self-adhesive) Y piece T piece Elbow Connecting tube Drain tubing Installation instructions	Included in 6040.3005	4 5 4 12 1 6m 1
Silicone tubing (2.80 mm O.D. x 1.30 mm I.D.)	Included in 6000.0010	3 m
Retaining guide (for seal wash reservoir)	Included in 6000.0042	2
Fitting plug (stainless steel, Viper)	6040.2303	1
Union, Viper	6040.2304	1
Tubing connector (straight, for I.D. 1.0 - 2.0 mm)	Included in 6040.9502	5
Solvent supply line filter, including: Filter holder (top and bottom parts) and Filter frit (stainless steel, porosity: 10 µm)	Included in 6268.0115 Included in 6268.0110	1
Tool kit for UltiMate 3000 RS, SD, BM pumps, and NCS-3500RS/NCP-3200RS, including: 1 open-end wrench (1/4" x 5/16") 2 open-end wrenches (11 x 13 mm) 1 hexagon wrench (size 6 mm) 1 piston seal removal and insertion tool 1 pump head tool for RS/SD pumps and 1 pump head tool for BM pumps and NCS-3500RS/NCP-3200RS (the tool is required for establishing the distance during piston installation)	6007.9304	1
Seal wash reservoir, 250 mL	Included in 2270.0026	1
Bottle cap for the seal wash reservoir	Included in 2270.0026	1
Plastic syringe (12 mL)	Included in 6000.0010	1 syringe
Chromeleon Service Release DVD	4580.0316	1
HPLC Troubleshooting Guide Poster	6040.0050	1
Viper capillary kit for UltiMate 3000 Standard System (single-stack setup), including 1 capillary (0.18 x 250 mm (I.D. x L), stainless steel, Viper) e.g., to connect the TCC-3000SD (column outlet) to a DAD-3000, MWD-3000, or VWD-3100 1 capillary (0.18 x 350 mm (I.D. x L), stainless steel, Viper) e.g., to connect the WPS-3000SL to the TCC-3000SD (column inlet) 1 capillary (0.18 x 550 mm (I.D. x L), stainless steel, Viper) e.g., to connect the pump to the WPS-3000SL	6040.2309	1

Description	Part No.	Quantity in the kit
USB cable, type A to type B, high speed USB 2.0 (cable length: 1 m)	6035.9035	1
USB cable, type A to type B, high speed USB 2.0 (cable length: 5 m)	6911.0002	1

11.1.2 RS Pumps

Description	Part No.	Quantity in the kit
Accessories kit of LPG-3400RS and DGP-3600RS		
Fuse, 2A, slow-blow (5 x 20 mm)	Included in 6030.9003	2
Components for UltiMate 3000 system drainage: Cable clips (self-adhesive) Y piece T piece Elbow Connecting tube Drain tubing Installation instructions	Included in 6040.0005	4 5 4 12 1 6m 1
Labels for solvent tubing 3.0 mm, both red and green	----	6 each
Silicone tubing (2.80 mm O.D. x 1.30 mm I.D.)	Included in 6000.0010	3 m
Retaining guide (for seal wash reservoir)	Included in 6000.0042	2
Tubing connector (straight, for I.D. 1.0 - 2.0 mm)	Included in 6040.9502	5
Solvent supply line filter, including: Filter holder (top and bottom parts) and Filter frit (titanium, porosity: 10 µm) + 5 replacement frits	Included in 6268.0115 Included in 6268.0111	1
Tool kit for UltiMate 3000 RS, SD, BM pumps, and NCS-3500RS/NCP-3200RS, including: 1 open-end wrench (1/4" x 5/16") 2 open-end wrenches (11 x 13 mm) 1 hexagon wrench (size 6 mm) 1 piston seal removal and insertion tool 1 pump head tool for RS/SD pumps and 1 pump head tool for BM pumps and NCS-3500RS/NCP-3200RS (the tool is required for establishing the distance during piston installation)	6007.9304	1
Fitting plug (Viper, stainless steel)	6040.2303	1
Union, Viper	6040.2304	1
Seal wash reservoir, 250 mL	Included in 2270.0026	1
Bottle cap for the seal wash reservoir	Included in 2270.0026	1
Plastic syringe (12 mL)	Included in 6000.0010	1 syringe
Viper capillary kit for UltiMate 3000 RSLC System (single-stack setup), including 1 capillary (0.13 x 250 mm (I.D. x L), stainless steel, Viper) e.g., to connect the TCC-3000RS (column outlet) to a DAD-3000RS, MWD-3000RS, or VWD-3100RS 1 capillary (0.13 x 350 mm (I.D. x L), stainless steel, Viper) e.g., to connect the WPS-3000RS to the TCC-3000RS (column inlet) 1 capillary (0.18 x 450 mm (I.D. x L), stainless steel, Viper) e.g., to connect the pump to the WPS-3000RS	6040.2301	1

Description	Part No.	Quantity in the kit
Chromeleon Service Release DVD	4580.0316	1
HPLC Troubleshooting Guide Poster	6040.0050	1
Installation tool for Viper capillaries with torque toothing	6040.2314	1
USB cable, type A to type B, high speed USB 2.0 (cable length: 1 m)	6035.9035	1
USB cable, type A to type B, high speed USB 2.0 (cable length: 5 m)	6911.0002	1

Description	Part No.	Quantity in the kit
Accessories kit of HPG-3200RS and HPG-3400RS		
Fuse, 2A, slow-blow (5 x 20 mm)	Included in 6030.9003	2
Components for UltiMate 3000 system drainage: Cable clips (self-adhesive) Y piece T piece Elbow Connecting tube Drain tubing Installation instructions	Included in 6040.0005	4 5 4 12 1 6m 1
Silicone tubing (2.80 mm O.D. x 1.30 mm I.D.)	Included in 6000.0010	3 m
Retaining guide (for seal wash reservoir)	Included in 6000.0042	2
Tubing connector (straight, for I.D. 1.0 - 2.0 mm)	Included in 6040.9502	5
Solvent supply line filter, including: Filter holder (top and bottom parts) and Filter frit (titanium, porosity: 10 µm) + 5 replacement frits	Included in 6268.0115 Included in 6268.0111	1
Tool kit for UltiMate 3000 RS, SD, BM pumps, and NCS-3500RS/NCP-3200RS, including: 1 open-end wrench (1/4" x 5/16") 2 open-end wrenches (11 x 13 mm) 1 hexagon wrench (size 6 mm) 1 piston seal removal and insertion tool 1 pump head tool for RS/SD pumps and 1 pump head tool for BM pumps and NCS-3500RS/NCP-3200RS (the tool is required for establishing the distance during piston installation)	6007.9304	1
Fitting plug (Viper, stainless steel)	6040.2303	1
Union, Viper	6040.2304	1
Seal wash reservoir, 250 mL	Included in 2270.0026	1
Bottle cap for the seal wash reservoir	Included in 2270.0026	1

Description	Part No.	Quantity in the kit
Plastic syringe (12 mL)	Included in 6000.0010	1 syringe
Chromleon Service Release DVD	4580.0316	1
HPLC Troubleshooting Guide Poster	6040.0050	1
Viper capillary kit for UltiMate 3000 RSLC System (single-stack setup), including 1 capillary (0.13 x 250 mm (I.D. x L), stainless steel, Viper) e.g., to connect the TCC-3000RS (column outlet) to a DAD-3000RS, MWD-3000RS, or VWD-3100RS 1 capillary (0.13 x 350 mm (I.D. x L), stainless steel, Viper) e.g., to connect the WPS-3000RS to the TCC-3000RS (column inlet) 1 capillary (0.18 x 550 mm (I.D. x L), stainless steel, Viper) e.g., to connect the pump to the WPS-3000RS	6040.2308	1
Installation tool for Viper capillaries with torque toothing	6040.2314	1
USB cable, type A to type B, high speed USB 2.0 (cable length: 1 m)	6035.9035	1
USB cable, type A to type B, high speed USB 2.0 (cable length: 5 m)	6911.0002	1

11.1.3 BM Pumps

Description	Part No.	Quantity in the kit
Accessories kit of BM pumps (except ISO-3100BM):		
Fuse, 2A, slow-blow (5 x 20 mm)	Included in 6030.9003	2
Components for UltiMate 3000 system drainage: Cable clips (self-adhesive) Y piece T piece Elbow Connecting tube Drain tubing Installation instructions	Included in 6040.0005	4 5 4 12 1 6m 1
Labels for solvent tubing 3.0 mm, both red and green	----	6 each
Silicone tubing (2.80 mm O.D. x 1.30 mm I.D.)	Included in 6000.0010	3 m
Retaining guide (for seal wash reservoir)	Included in 6000.0042	2
Tubing connector (straight, for I.D. 1.0 - 2.0 mm)	Included in 6040.9502	5
Solvent supply line filter, including: Filter holder (top and bottom parts) and Filter frit (PEEK, porosity: 10 µm)	Included in 6268.0115 Included in 6268.0117	2
Tool kit for UltiMate 3000 RS, SD, BM pumps, and NCS-3500RS/NCP-3200RS, including: 1 open-end wrench (1/4" x 5/16") 2 open-end wrenches (11 x 13 mm) 1 hexagon wrench (size 6 mm) 1 piston seal removal and insertion tool 1 pump head tool for RS/SD pumps and 1 pump head tool for BM pumps and NCS-3500RS/NCP-3200RS (the tool is required for establishing the distance during piston installation)	6007.9304	1
Fitting plug (stainless steel, Viper)	6040.2303	1
Capillary (PEEK, 1/16", 0.25 mm I.D.) e.g., to be used as spare part or for special use	6251.6001	1
Seal wash reservoir, 250 mL	Included in 2270.0026	1
Bottle cap for the seal wash reservoir	Included in 2270.0026	1
Plastic syringe (12 mL)	Included in 6000.0010	1 syringe
HPLC Troubleshooting Guide Poster	6040.0050	1
USB cable, type A to type B, high speed USB 2.0 (cable length: 1 m)	6035.9035	1
USB cable, type A to type B, high speed USB 2.0 (cable length: 5 m)	6911.0002	1

Description	Part No.	Quantity in the kit
Accessories kit of ISO-3100BM:		
Fuse, 2A, slow-blow (5 x 20 mm)	Included in 6030.9003	2
Components for UltiMate 3000 system drainage: Cable clips (self-adhesive) Y piece T piece Elbow Connecting tube Drain tubing Installation instructions	Included in 6040.0005	4 5 4 12 1 6m 1
Silicone tubing (2.80 mm O.D. x 1.30 mm I.D.)	Included in 6000.0010	3 m
Retaining guide (for seal wash reservoir)	Included in 6000.0042	2
Tubing connector (straight, for I.D. 1.0 - 2.0 mm)	Included in 6040.9502	5
Solvent supply line filter, including: Filter holder (top and bottom parts) and Filter frit (PEEK, porosity: 10 µm)	Included in 6268.0115 Included in 6268.0117	1
Tool kit for UltiMate 3000 RS, SD, BM pumps, and NCS-3500RS/NCP-3200RS, including: 1 open-end wrench (1/4" x 5/16") 2 open-end wrenches (11 x 13 mm) 1 hexagon wrench (size 6 mm) 1 piston seal removal and insertion tool 1 pump head tool for RS/SD pumps and 1 pump head tool for BM pumps and NCS-3500RS/NCP-3200RS (the tool is required for establishing the distance during piston installation)	6007.9304	1
Fitting plug (stainless steel, Viper)	6040.2303	1
Capillary (PEEK, 1/16", 0.25 mm I.D.) e.g., to be used as spare part or for special use	6251.6001	1
Knurled screw (Viper)	---	2
Seal wash reservoir, 250 mL	Included in 2270.0026	1
Bottle cap for the seal wash reservoir	Included in 2270.0026	1
Plastic syringe (12 mL)	Included in 6000.0010	1 syringe
Chromeleon Service Release DVD	4580.0316	1
HPLC Troubleshooting Guide Poster	6040.0050	1
Solvent supply line from analytical degasser to pump head	6030.2546	1
USB cable, type A to type B, high speed USB 2.0 (cable length: 1 m)	6035.9035	1
USB cable, type A to type B, high speed USB 2.0 (cable length: 5 m)	6911.0002	1

11.1.4 HPG-3200BX

Description	Part No.	Quantity in the kit
Accessories kit of HPG-3200BX pump:		
Fuse, 2A, slow-blow (5 x 20 mm)	Included in 6030.9003	2
Components for UltiMate 3000 system drainage: Cable clips (self-adhesive) Y piece T piece Elbow Connecting tube Drain tubing Installation instructions	Included in 6040.0005	4 5 4 12 1 6 m 1
Silicone tubing (2.80 mm O.D. x 1.30 mm I.D.)	Included in 6000.0010	3 m
Retaining guide (for seal wash reservoir)	Included in 6000.0042	2
Tubing connector (straight, for I.D. 1.0 - 2.0 mm)	Included in 6040.9502	5
Solvent supply line filter, including: Filter holder and Filter frit (titanium, porosity: 10 µm, 6 frits)	Included in 6268.0116 Included in 6268.0111	1
Tool kit for UltiMate 3000 HPG-3200BX pumps, including: 1 open-end wrench (1/4" x 5/16") 1 open-end wrench (11 x 13 mm) 1 open-end wrench (17 x 19 mm) 1 hexagon wrench (size 6 mm) 1 piston seal removal and insertion tool 1 pump head tool (for establishing the distance during piston installation)	6007.9306	1
Fitting plug (stainless steel, Viper)	6040.2303	1
Capillary (PEEK, 1/16", 0.75 mm I.D.) e.g., to be used as spare part or for special use	2251.6003	2 m
Rheflex fittings (PEEK, 1/16", finger-tight) to be used with capillary, part no. 2251.6003	Included in 6000.0012	7
Seal wash reservoir, 250 mL	Included in 2270.0026	1
Bottle cap for the seal wash reservoir	Included in 2270.0026	1
Plastic syringe (12 mL)	Included in 6000.0010	1 syringe
Chromeleon Service Release DVD	4580.0316	1
HPLC Troubleshooting Guide Poster	6040.0050	1
USB cable, type A to type B, high speed USB 2.0 (cable length: 1 m)	6035.9035	1
USB cable, type A to type B, high speed USB 2.0 (cable length: 5 m)	6911.0002	1

11.2 Optional Accessories

Accessories	Description	Part No.
Diagnostics Tool kit	The kit includes all materials required for performing pump diagnostics from Chromeleon.	6040.3099
Capillary kit, Viper, standalone OAS-3x00TXRS	The kit includes the following Viper capillaries for connecting UltiMate 3000 modules in a system with a standalone OAS-3x00TXRS: 4 Viper capillaries, stainless steel (1 each of 0.10 x 65 mm, 0.10 x 250 mm, 0.13 x 750 mm, and 0.18 x 750 mm (I.D. x L))	6845.2301A
Capillary kit, Viper for UltiMate 3000 Bio RSLC System	Kit for UltiMate 3000 Bio RS systems (single stack) with UltiMate 3000 Bio RS pump The kit includes 3 Viper capillaries, MP35N (one each 0.10 x 250 mm, 0.10 x 350 mm, and 0.18 x 550 mm (I.D. x L)).	6841.2301
Signal cable	6-pin mini-DIN cable for connection to the Digital I/O port of the pump	6000.1004
Synchronization cable	To connect a pump to an OAS-3x00TXRS For connection details, see the <i>autosampler manual</i> .	6043.0001
<p>Piston seal, normal phase (SD(N) pumps and HPG-3200BX)</p> <p>If, in special NP applications, you observe problems with the silicone tubing of the seal wash system, replace the silicone tubing and detector of the seal wash system with the PharMed tubing and NP detector from the appropriate Normal Phase (NP) Kit (SD pumps, part no. 6040.1972; HPG-3200BX: part no. 6040.1975). For information about the kit content, see section 11.3 (→ page 224).</p> <p>Tip: Replacing these components is required also for running NP applications with SDN pumps.</p>		
Piston seal normal phase	<i>For SD pumps</i> The kit contains 2 seals (NP).	6040.0306
	<i>For HPG-3200BX</i> The kit includes 2 seals (NP) and 1 support ring.	6040.9011
<p>Capillary from working cylinder to equilibration cylinder (U-tube)</p>		
U-tube, Viper	<i>Available as an option for SD pumps</i> If, with flow rates of < 2 mL/min, leakage is observed around the connection ports of the U-tube with which the pump is shipped, consider installing this U-tube with Viper connections. (The capillary is not an appropriate choice for flow rates higher than 2 mL.)	6040.3008

Accessories	Description	Part No.
Manual Sample Injector Valve		
Sample injector valve, analytical	The valve can be used with pressures up to 50 MPa. The kit includes the valve with 20 µL sample loop, mounting angle, and all components required for the installation, as well as a capillary to connect the valve to the pump, plus detailed installation instructions.	6040.0610
Sample injector valve, biocompatible	The valve can be used with pressures up to 34 MPa. The kit includes the valve with 50 µL sample loop, mounting angle, and all components required for the installation, as well as a capillary to connect the valve to an analytical pump, plus detailed installation instructions. The valve can be used also together with the semipreparative HPG-3200BX pump. In this case, you have to order the following components in addition to the valve: Sample loop, 200 µL, PEEK (part no. 6042.8000) Syringe, 5 mL (part no. 6035.0670) or Syringe, 1 mL (part no. 6040.0620) To connect the valve to the pump, use the capillary (PEEK, 1/16", 0.75 mm I.D., part no. 2251.6003) and the RheFlex fittings (PEEK, 1/16", finger-tight, part no. 6000.0012) from the accessories kit of the pump.	6042.0600
Mounting angle for sample injector valves (6040.0610, 6042.0600)	The kit includes all components required for valve installation, appropriate capillaries to connect the valve to the pump, and detailed installation instructions; however, it does <i>not</i> include the valve.	6040.0611
Sample injector, UHPLC compatible	The valve can be used with pressures up to 103 MPa and is compatible with all UltiMate 3000 SD and RS pumps. The kit includes the valve, a mounting plate, and all components required for the installation, as well as two sample loops (5 µL and 20 µL), one syringe (100 µL), a capillary to connect the valve to the pump, plus detailed installation instructions.	6040.0110
Syringe for use with sample injector valve	100 µL syringe 5 mL syringe 1 mL syringe	6035.0665 6035.0670 6040.0620

Accessories	Description	Part No.
Two-step mixing system (SpinFlow) for RS and SD pumps (except ISO-3100)		
Mixing volume:	100 µL (for SD pumps)	6040.5100
	100 µL (for RS pumps)	6042.5100
	<i>SD and RS pumps:</i>	
	200 µL	6040.5110
	400 µL	6040.5310
	800 µL	6040.5750
	1550 µL	6040.5450
The shipment includes all components required for the installation and detailed instructions. Also observe the information on page 204.		
Single-step mixing system for SD pumps (except ISO-3100SD)		
Mixing volume: 35 µL	Kit including Capillary mixer, stainless steel (volume: 25 µL) and Inline filter, stainless steel (volume: 10 µL)	6040.5000
	The components of the kit are available also as separate parts: Capillary mixer, stainless steel (volume: 25 µL) Inline filter, stainless steel (volume: 10 µL)	
		6040.3020 6040.5010
Single-step mixing system for RS pumps		
Mixing volume: 35 µL	Kit including Capillary mixer, Viper, MP35N (volume: 25 µL) and Inline filter, titanium (volume: 10 µL)	6042.5000
	The components of the kit are available also as separate parts: Capillary mixer, Viper, MP35N (volume: 25 µL) Inline filter, titanium (volume: 10 µL)	
		6042.3020 6042.5014
Solvent Racks	For information about the range of applications, see page 18	
SR-3000	Solvent Rack without vacuum degasser	5035.9200
SRD-3200	Solvent Rack with analytical 2-channel vacuum degasser	5035.9250
SRD-3400	Solvent Rack with analytical 4-channel vacuum degasser	5035.9245
SRD-3600	Solvent Rack with analytical 6-channel vacuum degasser	5035.9230

11.3 Consumables and Spare Parts

The part number always refers to the packing unit. Unless otherwise stated, the packing unit is 1 unit.

Description	Part No.
Bottle cap (4 caps) for seal wash and solvent reservoirs (including caps to close the holes in the bottle cap)	6270.0013
Capillaries, capillary kit for ISO-3100BM, including: 1 capillary from working cylinder to equilibration cylinder (U-tube) 1 capillary from pump head to purge unit 1 capillary from purge unit to pulse damper 1 capillary from pulse damper to inline filter	6042.3002
Capillaries, capillary kit for LPG-3400BM and DGP-3600BM, including: 2 capillaries from working cylinder to equilibration cylinder (U-tubes) 2 capillaries from pump head to purge unit 2 capillaries from purge unit to inline filter <i>Note:</i> The capillary from purge unit to inline filter can be ordered also separately (part no. 6042.3024).	6042.3001
Capillaries, stainless steel, kit for HPG-3x00SD, including: 2 capillaries from working cylinder to equilibration cylinder (U-tubes) 1 capillary from left pump head to purge unit 1 capillary from right pump head to purge unit	6040.3000
Capillaries, stainless steel, kit for ISO-3100SD, LPG-3400SD, and DGP-3600SD, including: 2 capillaries from working cylinder to equilibration cylinder (U-tubes) 2 capillaries from head to purge unit	6040.3001
Capillaries, capillary kit for HPG-3200BX, including: 2 capillaries from working cylinder to equilibration cylinder (U-tube) 1 capillary from left pump head to purge unit 1 capillary from right pump head to purge unit 1 capillary from purge unit to static mixer	6042.3005
<i>Capillaries, Viper, for UltiMate 3000 Bio RS systems (single stack setup)</i> <i>A—Viper capillaries</i> Capillary (0.18 x 550 mm (I.D. x L), MP35, Viper) e.g. for the connection from the RS pump to the WS-3000TBRS Capillary (0.10 x 350 mm (I.D. x L), MP35N, Viper) e.g., for the connection from the WPS-3000TBRS to the TCC-3000RS (column inlet) Capillary (0.10 x 250 mm (I.D. x L), MP35N, Viper) e.g., for the connection from the TCC-3000RS (column outlet) to the DAD-3000RS, MWD-3000RS, or VWD-3400RS <i>B - Viper capillary kit</i> Viper capillary kit for Bio RS system with UltiMate 3000 RS pump The kit includes the capillaries with part numbers 6042.2355, 6042.2340, and 6042.2330 (for details, see 'A—Viper capillaries').	6042.2355 6042.2340 6042.2330 6841.2301

Description	Part No.
<p><i>Capillaries, Viper, for UltiMate 3000 RSLC systems (single stack setup)</i></p> <p><i>A—Viper capillaries</i></p> <p>Capillary (0.13 x 550 mm (I.D. x L), stainless steel, Viper) 6040.2305</p> <p>Capillary (0.18 x 450 mm (I.D. x L), stainless steel, Viper) 6040.2365 e.g., for the connection from the LPG-3400RS/DGP-3600RS pump to the WPS-3000RS</p> <p>Capillary (0.18 x 550 mm (I.D. x L), stainless steel, Viper) 6040.2355 e.g., for the connection from the HPG-3x00RS to the WPS-3000RS</p> <p>Capillary (0.13 x 350 mm (I.D. x L), stainless steel, Viper) 6040.2335 e.g., for the connection from the WPS-3000RS to the TCC-3000RS (column inlet)</p> <p>Capillary (0.13 x 250 mm (I.D. x L), stainless steel, Viper) 6040.2325 e.g., for the connection from the TCC-3000RS (column outlet) to the DAD-3000RS, MWD-3000RS, or VWD-3400RS</p> <p>Capillary (0.13 x 150 mm (I.D. x L), stainless steel, Viper) 6040.2315</p> <p><i>B—Viper capillary kits</i></p> <p>Viper capillary kit for RSLC systems with LPG-3400RS or DGP-3600RS The kit includes the capillaries with part numbers 6040.2325, 6040.2335, and 6040.2365 (for details see 'A—Viper capillaries'). 6040.2301</p> <p>Viper capillary kit for RSLC system with HPG-3200RS or HPG-3400RS The kit includes the capillaries with part numbers 6040.2325, 6040.2335, and 6040.2355 (for details, see 'A—Viper capillaries'). 6040.2308</p>	
<p><i>Capillaries, Viper, for UltiMate 3000 standard systems (single stack setup)</i></p> <p><i>A—Viper capillaries</i></p> <p>Capillary (0.18 x 550 mm (I.D. x L), stainless steel, Viper) 6040.2355 e.g., for the connection from the ACC-3000 to the column inlet</p> <p>Capillary (0.18 x 450 mm (I.D. x L), stainless steel, Viper) 6040.2365 e.g., for the connection from the SD pump to the WPS-3000SL</p> <p>Capillary (0.18 x 350 mm (I.D. x L), stainless steel, Viper) 6040.2375 e.g., for the connection from the WPS-3000SL to the TCC-3000SD (column inlet)</p> <p>Capillary (0.18 x 250 mm (I.D. x L), stainless steel, Viper) 6040.2385 e.g., for the connection from the TCC-3000SD (column outlet) to the DAD-3000, MWD-3000, or VWD-3100</p> <p><i>B—Viper capillary kits</i></p> <p>Viper capillary kit for standard system including ISO-3100SD, LPG-3400SD, or DGP-3600SD. 6040.2302 The kit includes the capillaries with part numbers 6040.2365, 6040.2375, and 6040.2385 (for details, see 'A—Viper capillaries').</p> <p>Viper capillary kit for standard systems with HPG-3200SD or HPG-3400SD. 6040.2309 The kit includes the capillaries with part numbers 6040.2355, 6040.2375, and 6040.2385 (for details, see 'A—Viper capillaries').</p>	
<p>Capillaries, Viper, MP35N, kit for HPG-3x00RS (\geq S/N 8030113), including: 2 capillaries from working cylinder to equilibration cylinder (U-tubes) 1 capillary from left pump head to purge unit 1 capillary from right pump head to purge unit</p>	6040.3002

Description	Part No.
Capillaries, Viper, MP35N, kit LPG-3400RS and DGP-3600RS (\geq S/N 8030113), including: 2 capillaries from working cylinder to equilibration cylinder (U-tubes) 2 capillaries from head to purge unit	6040.3003
Capillary (1/16", I.D. 0.75 mm) for HPG-3200BX (without fittings) With this capillary, use the Rheflex fittings (PEEK, 1/16", finger-tight), part no. 6000.0012 (10 fittings).	2251.6003
Capillary (PEEK, 1/16" x 0.25 mm O.D. x I.D.), BM pumps	6251.6001
<i>Capillary from purge unit to inline filter</i> ISO-3100SD LPG-3400BM and DGP-3600BM (The capillary is included also in the capillary kit for the LPG-3400BM and DGP-3600BM pumps, part no. 6042.3001.)	6040.3024 6042.3024
Capillary from working cylinder to equilibration cylinder (U-tube), Viper Available as an option for SD pumps If, with flow rates of < 2 mL/min, leakage is observed around the connection ports of the U-tube with which the pump is shipped, consider installing this U-tube with Viper connections. (The capillary is not an appropriate choice for flow rates higher than 2 mL.)	6040.3008
Capillary mixer \rightarrow Mixer, capillary mixer	
Caps and retaining guides for solvent bottles, kit of 10 caps (to close the holes in the solvent bottle caps) and 5 retaining guides (for solvent bottle)	6030.9101
Check valve, cartridge, ceramics The cartridge is the same for both the inlet and outlet valve.	6041.2301
<i>Check valve, valve nut for double check valve, including:</i> Outlet check valve nut and inlet check valve nut for SD pumps (stainless steel nuts) RS, BM, and BX pumps (titanium nuts)	6040.7007 6042.7007
Cleaning swabs (10 swabs) (for example, to clean the connection ports on the pump block or purge unit)	6040.0006
Detector (rear seal wash system) \rightarrow Rear seal wash system, detector	
Diagnostics Tool kit The kit includes all materials required for performing the tests.	6040.3099
Drain kit for UltiMate 3000 systems The kit includes all required components and detailed installation instructions.	6040.0005
<i>Filter frit for inline filter</i> Frit (titanium, 2 μ m) for inline filter, titanium (volume: 10 μ L) in LPG-3400BM and DGP-3600BM and in single-step mixing system for RS pumps Frit (titanium, 10 μ m) for inline filter, stainless steel (volume: 10 μ L) in single-step mixing system for SD pumps	6268.0036 6268.0034

Description	Part No.
<i>Filter frit for solvent supply line filter</i> SD pumps (stainless steel, porosity: 10 µm, 10 frits) RS and BX pumps (titanium, porosity: 10 µm, 10 frits) BM pumps (PEEK, porosity: 10 µm, 10 frits)	6268.0110 6268.0111 6268.0117
Fitting plug (stainless steel, Viper)	6040.2303
Fuses kit, including: 15 fuses, overload protection (2A, slow-blow, 5 x 20 mm) 5 fuses (0.20A slow-blow, 5 x 20 mm) 5 fuses (4A, slow-blow, 6.3 x 32 mm) 2 fuses (4A, slow-blow, 5 x 20 mm) <i>Note:</i> Use only the slow-blow fuses rated at 2A (5 x 20 mm) with the pump.	6030.9003
<i>Inline filter</i> Inline filter (volume: 150 µL) for ISO-3100 Inline filter (volume: 10 µL) for use with capillary mixer (volume: 25 µL) in single-step mixing system for SD pumps (except ISO-3100SD) Inline filter (volume: 10 µL) for use with the capillary mixer (volume: 25 µL) in single-step mixing system for RS pumps Inline filter (volume: 10 µL) for LPG-3400BM and DGP-3600BM	6040.5110 6040.5010 6042.5014 6042.5014
Inline filter, filter frits → Filter frits, inline filter	
Installation tool for Viper capillaries with torque toothing → Tool, installation tool for Viper capillaries	
Maintenance kit for DGP-3600BM—including: 6 solvent filters with filter frits 1.5 m silicone tubing (O.D. x I.D. 2.80 mm x 1.30 mm) 18 cm PharMed tubing (O.D. x I.D. 3.2 mm x 1.6 mm) 5 tubing connectors, straight, for I.D. 1.0-2.0 mm 4 piston seals (reversed phase), main piston seals 4 piston seals (normal phase), plate of seal wash system 4 support rings 2 O-ring seals (PTFE; 9x1.5 and 32x1.5) each for seal wash system 2 valve cartridges (ceramics) 2 filter frits (titanium, 2 µm) 2 cap seals for purge valve knob (<i>only</i> for knobs <i>without</i> integrated cap seal) 10 cleaning swabs	6042.1952
Maintenance kit for DGP-3600RS—including: 6 solvent filters with filter frits 1.5 m silicone tubing (O.D. x I.D. 2.80 mm x 1.30 mm) 18 cm PharMed tubing (O.D. x I.D. 3.2 mm x 1.6 mm) 5 tubing connectors, straight, for I.D. 1.0-2.0 mm 4 piston seals (reversed phase), main piston seals 4 piston seals (normal phase), plate of seal wash system 2 O-ring seals (PTFE; 9x1.5 and 32x1.5) each for seal wash system 2 valve cartridges (ceramics) 2 cap seals for purge valve knob (<i>only</i> for knobs <i>without</i> integrated cap seal) 10 cleaning swabs	6040.1955A

Description	Part No.
<p>Maintenance kit for DGP-3600SD—including:</p> <ul style="list-style-type: none"> 6 solvent filters with filter frits 1.5 m silicone tubing (O.D. x I.D. 2.80 mm x 1.30 mm) 18 cm PharMed tubing (O.D. x I.D. 3.2 mm x 1.6 mm) 5 tubing connectors, straight, for I.D. 1.0-2.0 mm 4 piston seals (reversed phase), main piston seals 4 piston seals (normal phase), plate of seal wash system 4 support rings (<i>only</i> for pumps with max. working pressure ≤ 50 MPa) 2 O-ring seals (PTFE; 9x1.5 and 32x1.5) each for seal wash system 2 valve cartridges (ceramics) 2 cap seals for purge valve knob (<i>only</i> for knobs <i>without</i> integrated cap seal) 10 cleaning swabs 	6040.1952
<p>Maintenance kit for HPG-3x00RS—including:</p> <ul style="list-style-type: none"> 4 solvent filters with filter frit 1.5 m silicone tubing (O.D. x I.D. 2.80 mm x 1.30 mm) 18 cm PharMed tubing (O.D. x I.D. 3.2 mm x 1.6 mm) 5 tubing connectors, straight, for I.D. 1.0-2.0 mm 4 piston seals (reversed phase), main piston seals 4 piston seals (normal phase), seal in plate of the seal wash system 2 O-ring seals (PTFE; 9x1.5 and 32x1.5) each for seal wash system 2 valve cartridges (ceramics) 1 cap seal for purge valve knob (<i>only</i> for knobs <i>without</i> integrated cap seal) 10 cleaning swabs 	6040.1956A
<p>Maintenance kit for HPG-3x00SD—including:</p> <ul style="list-style-type: none"> 4 solvent filters with filter frit 1.5 m silicone tubing (O.D. x I.D. 2.80 mm x 1.30 mm) 18 cm PharMed tubing (O.D. x I.D. 3.2 mm x 1.6 mm) 5 tubing connectors, straight, for I.D. 1.0-2.0 mm 4 piston seals (reversed phase), main piston seals 4 piston seals (normal phase), seal in plate of the seal wash system 4 support rings (<i>only</i> for pumps with max. working pressure ≤ 50 MPa) 2 O-ring seals (PTFE; 9x1.5 and 32x1.5) each for seal wash system 2 valve cartridges (ceramics) 1 cap seal for purge valve knob (<i>only</i> for knobs <i>without</i> integrated cap seal) 10 cleaning swabs 	6040.1953
<p>Maintenance kit for ISO-3100BM—including:</p> <ul style="list-style-type: none"> 1 solvent filter with filter frits 1.5 m silicone tubing (O.D. x I.D. 2.80 mm x 1.30 mm) 18 cm PharMed tubing (O.D. x I.D. 3.2 mm x 1.6 mm) 3 tubing connectors, straight, for I.D. 1.0-2.0 mm 2 piston seals (reversed phase), main piston seals 2 piston seals (normal phase), seal in plate of seal wash system 2 support rings 1 O-ring seal (PTFE; 9x1.5 and 32x1.5) each for seal wash system 1 valve cartridge (ceramics) 1 cap seal for purge valve knob (<i>only</i> for knobs <i>without</i> integrated cap seal) 5 cleaning swabs 	6042.1950

Description	Part No.
<p>Maintenance kit for ISO-3100SD—including:</p> <ul style="list-style-type: none"> 1 solvent filter with filter frit 1.5 m silicone tubing (O.D. x I.D. 2.80 mm x 1.30 mm) 18 cm PharMed tubing (O.D. x I.D. 3.2 mm x 1.6 mm) 3 tubing connectors, straight, for I.D. 1.0-2.0 mm 2 piston seals (reversed phase), main piston seals 2 piston seals (normal phase), seal in plate of the seal wash system 2 support rings (<i>only</i> for pumps with max. working pressure ≤ 50 MPa) 1 O-ring seal (PTFE; 9x1.5 and 32x1.5) each for seal wash system 1 valve cartridge (ceramics) 1 cap seal for purge valve knob (<i>only</i> for knobs <i>without</i> integrated cap seal) 5 cleaning swabs 	6040.1950
<p>Maintenance kit for LPG-3400BM—including:</p> <ul style="list-style-type: none"> 4 solvent filters with filter frits 1.5 m silicone tubing (O.D. x I.D. 2.80 mm x 1.30 mm) 18 cm PharMed tubing (O.D. x I.D. 3.2 mm x 1.6 mm) 3 tubing connectors, straight, for I.D. 1.0-2.0 mm 2 piston seals (reversed phase), main piston seals 2 piston seals (normal phase), seal in plate of seal wash system 2 support rings 1 O-ring seal (PTFE; 9x1.5 and 32x1.5) each for seal wash system 1 filter frit (titanium, 2 μm) for inline filter 1 valve cartridge (ceramics) 1 cap seal for purge valve knob (<i>only</i> for knobs <i>without</i> integrated cap seal) 5 cleaning swabs 	6042.1951
<p>Maintenance kit for LPG-3400RS—including:</p> <ul style="list-style-type: none"> 4 solvent filters with filter frit 1.5 m silicone tubing (O.D. x I.D. 2.80 mm x 1.30 mm) 18 cm PharMed tubing (O.D. x I.D. 3.2 mm x 1.6 mm) 3 tubing connectors, straight, for I.D. 1.0-2.0 mm 2 piston seals (reversed phase), main piston seals 2 piston seals (normal phase), seal in plate of the seal wash system 1 O-ring seal (PTFE; 9x1.5 and 32x1.5) each for seal wash system 1 valve cartridge (ceramics) 1 cap seal for purge valve knob (<i>only</i> for knobs <i>without</i> integrated cap seal) 5 cleaning swabs 	6040.1954A
<p>Maintenance kit for LPG-3400SD—including:</p> <ul style="list-style-type: none"> 4 solvent filters with filter frit 1.5 m silicone tubing (O.D. x I.D. 2.80 mm x 1.30 mm) 18 cm PharMed tubing (O.D. x I.D. 3.2 mm x 1.6 mm) 3 tubing connectors, straight, for I.D. 1.0-2.0 mm 2 piston seals (reversed phase), main piston seals 2 piston seals (normal phase), seal in plate of the seal wash system 2 support rings (<i>only</i> for pumps with max. working pressure ≤ 50 MPa) 1 O-ring seal (PTFE; 9x1.5 and 32x1.5) each for seal wash system 1 valve cartridge (ceramics) 1 cap seal for purge valve knob (<i>only</i> for knobs <i>without</i> integrated cap seal) 5 cleaning swabs 	6040.1951

Description	Part No.
Maintenance kit, NP, for HPG-3200BX—including: 2 solvent supply line filters with filter frits 1.5 m PharMed tubing (O.D. x I.D. 3.2 mm x 1.6 mm) 5 tubing connectors, straight, for I.D. 1.0-2.0 mm 4 piston seals (normal phase) 4 support rings 2 O-ring seals (PTFE; 9x1.5 and 32x1.5) each for seal wash system 2 valve cartridges (ceramics) 10 cleaning swabs	6042.1954
Maintenance kit, RP, for HPG-3200BX—including: 2 solvent supply line filters with filter frits 1.5 m silicone tubing (O.D. x I.D. 2.80 mm x 1.30 mm) 18 cm PharMed tubing (O.D. x I.D. 3.2 mm x 1.6 mm) 5 tubing connectors, straight, for I.D. 1.0-2.0 mm 4 piston seals (reversed phase) 4 support rings 2 O-ring seals (PTFE; 9x1.5 and 32x1.5) each for seal wash system 2 valve cartridges (ceramics) 10 cleaning swabs	6042.1953
Menu pen	6300.0100
<i>Mixer, capillary mixer, stainless steel, for SD pumps (except ISO-3100SD)</i> Capillary mixer (volume: 25 µL) to be used with: - Static mixer (volume: 75 µL) in the two-step mixing system (100 µL) - Inline filter (volume: 10 µL, part no. 6040.5010) in the single-step mixing system Capillary mixer (volume: 50 µL) ¹ for LPG-3400SD DGP-3600SD HPG-3x00SD ¹ To be used in two-step mixing systems with mixing volumes > 100 µL.	6040.3020 6040.3026 6040.3025 6040.3015
<i>Mixer, capillary mixer, Viper, MP35M for RS pumps (≥ S/N 8030113)</i> Capillary mixer (volume: 25 µL) to be used with: - Static mixer (volume: 75 µL) in the two-step mixing system (100 µL) - Inline filter (volume: 10 µL, part no. 6042.5014) in the single-step mixing system Capillary mixer (volume: 50 µL) ¹ for LPG-3400RS DGP-3600RS HPG-3x00RS ¹ To be used in two-step mixing systems with mixing volumes > 100 µL.	6042.3020 6042.3026 6042.3025 6042.3015

Description	Part No.
<p><i>Mixer, static mixer for RS pumps and SD pumps (except ISO-3100SD)</i></p> <p>Static mixer (volume: 75 µL)¹ (SD pumps) 6040.5100 Static mixer (volume: 75 µL)¹ (RS pumps ≥ S/N 8030113) 6042.5100 Static mixer (volume: 150 µL)² 6040.5110 Static mixer (volume: 350 µL)² 6040.5310 Static mixer (volume: 750 µL)² 6040.5750 Static mixer (volume: 1500 µL)² 6040.5450</p> <p>¹ The mixer is used together with an appropriate capillary mixer (volume: 25 µL) in the two-step mixing system (mixing volume: 100 µL). The capillary mixer is included in the shipment.</p> <p>² These static mixers are used with a capillary mixer (volume: 50 µL). The capillary mixer is installed when the pump is shipped, and thus it is <i>not</i> included in the shipment.</p>	
<p><i>Mixer, static mixer, for HPG-3200BX</i></p> <p>Static mixer (volume: 750 µL) 6040.5750</p>	
<p><i>Mixing system, stainless steel (volume: 35 µL), single-step, for SD pumps (except ISO-3100SD), including</i></p> <p>Capillary mixer n(volume: 25 µL) and Inline filter (volume: 10 µL) 6040.5000</p>	
<p><i>Mixing system, titanium/MP35N (volume: 35 µL), single-step for RS pumps (≥ S/N 8030113), including</i></p> <p>Capillary mixer, Viper, MP35N (volume: 25 µL) and Inline filter, titanium (volume: 10 µL) 6042.5000</p>	
<p>Normal Phase (NP) Kit for HPG-3200BX, including:</p> <p>PharMed tubing (1 m, O.D. x I.D., 3.20 x 1.60 mm)* 1 detector (NP) for rear seal wash system 1 tubing connector, straight, for I.D. 1.0 - 2.0 mm 8 piston seals, normal phase (→ Fig. 38, page 147, nos. 3 and 7) 4 support rings</p> <p>* If, in special NP applications, you observe problems with the silicone tubing of the seal wash system, consider replacing the silicone tubing and detector of the seal wash system with the PharMed tubing and NP detector from this kit.</p>	6040.1975
<p>Normal Phase (NP) Kit for SD(N) pumps, including:</p> <p>PharMed tubing (1 m, O.D. x I.D., 3.20 x 1.60 mm)* 1 detector (NP) for rear seal wash system 1 tubing connector, straight, for I.D. 1.0 - 2.0 mm 8 piston seals, normal phase (→ Fig. 37, page 143, nos. 3 and 7) 4 support rings (only for SD pumps with a working pressure of ≤ 50 MPa)</p> <p>* If, in special NP applications, you observe problems with the silicone tubing of the seal wash system, consider replacing the silicone tubing and detector of the seal wash system with the PharMed tubing and NP detector from this kit.</p> <p><i>Tip:</i> Replacing these components is required also for running NP applications with SDN pumps.</p>	6040.1972
<p><i>Piston</i></p> <p>All pump types except HPG-3200BX (sapphire, 2 pistons) 6040.0042 HPG-3200BX (ceramics, 2 pistons) 6040.0842</p>	

Description	Part No.
Piston seal (in plate of seal wash system) for RS, SD, and BM pumps: Normal Phase (2 seals) HPG-3200BX: Reversed Phase (the kit includes 2 seals and 1 support ring)	6040.0306 6040.9010
Piston seal (main piston seal) for <i>SD pumps</i> Reversed Phase (2 seals) Normal Phase (2 seals) <i>SDN pumps</i> Normal Phase (2 seals)	6040.0304 6040.0306 6040.0306
Piston seal (main piston seal) for BM pumps Reversed Phase (the kit includes 2 seals and 1 support ring)	6025.2012
Piston seal (main piston seal) for HPG-3200BX Reversed Phase (the kit includes 2 seals and 1 support ring) Normal Phase (the kit includes 2 seals and 1 support ring)	6040.9010 6040.9011
Piston seal (main piston seal) for RS pumps Reversed Phase (2 seals)	6266.0305
Power cord, Australia, China	6000.1060
Power cord, Denmark	6000.1070
Power cord, EU	6000.1000
Power cord, India/SA	6000.1090
Power cord, Italy	6000.1040
Power cord, Japan	6000.1050
Power cord, Switzerland	6000.1030
Power cord, UK	6000.1020
Power cord, US	6000.1001
<i>Pump head, entire assembly, for</i> HPG-3x00RS HPG-3x00SD HPG-3200BX LPG-3400RS and DGP-3600RS ISO-3100SD, LPG-3400SD ¹ , and DGP-3600SD ¹ ISO-3100BM, LPG-3400BM, and DGP-3600BM ¹ This pump head has reversed phase seals installed as main piston seals. You can use the pump head also with SDN pumps. However, in this case, consider replacing the reversed phase seals with normal phase seals (→ page 158).	6040.1901B 6040.1903A 6042.1901 6040.1902B 6040.1904A 6042.1902
Purge valve knob	6040.2035
Rear seal wash system, detector Note the information for NP applications (→ page 95).	6040.4131
Rear seal wash system, reservoir, 0.25L including bottle cap	2270.0026

Description	Part No.
Rear seal wash system, seal ring (→ nos. 4 and 8 in Fig. 37, page 143 and no. 4 in Fig. 38, page 147) PTFE seals, 9x1.5 mm and 32x1.5 mm, 5 each	6040.2208
Rear seal wash system, tubing kit, including: silicone tubing (1.5 m, O.D. x I.D. 2.80 x 1.30 mm) PharMed tubing (18 cm, O.D. x I.D., 3.20 x 1.60 mm) 7 tubing connectors, straight, for tubing I.D. 1.0 - 2.0 mm	6040.9502
Retaining guide (for seal wash reservoir and solvent reservoirs)	6000.0042
Rheflex fittings (PEEK, 1/16", finger-tight, 10 fittings) To be used with the PEEK capillary (1/16", 0.75 mm I.D.), part no. 2261.6003	6000.0012
Seals, rear seal wash system → Rear seal wash system, seals	
Shut off valve for solvent supply line (HPG-3200BX), set including 1 shut off valve for solvent supply line 1 tubing adapter (1/8")	6042.2531
Signal cable (6-pin, mini-DIN)	6000.1004
<i>Solvent line filter</i> Filter holder (6 holders), all pump types except HPG-3200BX Filter holder (2 holders), HPG-3200BX Filter frit (stainless steel, porosity: 10 µm, 10 frits), SD pumps Filter frit (titanium, porosity: 10 µm, 10 frits), RS and BX pumps Filter frit (PEEK, porosity: 10 µm, 10 frits), BM pumps	6268.0115 6268.0116 6268.0110 6268.0111 6268.0117
Solvent supply line from analytical degasser to pump head HPG-3200SD and HPG-3200RS (Kit with 2 solvent supply lines, fitting connections, and line labels)	6035.2530
Solvent supply line from degasser to proportioning valve, DGP-3600 (Kit with 3 solvent supply lines, fitting connections, and line labels)	6030.2547
Solvent supply line from degasser to pump head, ISO-3100 (Kit with 1 solvent supply line, fitting connections, and line labels)	6030.2546
Solvent supply line to the LPG-3400 degasser (Kit with 4 solvent supply lines, fitting connections, and line labels)	6040.2049
Solvent supply line, HPG-3200BX (Kit with 2 solvent supply lines with adapter for the connection to inlet valve) to connect the solvent reservoirs directly to the pump	6042.2530
Solvent supply line, ISO-3100BM for connecting the solvent reservoirs directly to the pump	6030.2548
Solvent supply lines from degasser to solvent selector, HPG-3400 (Kit with 4 solvent supply lines, fitting connections, and line labels)	6035.2532
Static mixer → Mixer, static mixer	
Support ring for pistons seals in RS and SD pumps (2 support rings)	6040.0012
Support ring/piston seal kit (reversed phase) for BM pumps The kit includes 2 piston seals (reversed phase) and 1 support ring.	6025.2012

Description	Part No.
Support ring/pistons seal kit for HPG-3200BX Kit with 1 support ring and 2 seals (reversed phase) Kit with 1 support ring and 2 seals (normal phase)	6040.9010 6040.9011
Syringe and tubing kit, including: 5 plastic syringes 3m silicone tubing (O.D. x I.D. 2.80 mm x 1.30 mm)	6000.0010
Tool kit for UltiMate 3000 HPG-3200BX pumps, including: 1 open-end wrench (1/4" x 5/16") 1 open-end wrench (11 x 13 mm) 1 open-end wrench (17 x 19 mm) 1 hexagon wrench (size 6 mm) 1 piston seal removal and insertion tool 1 pump head tool (for establishing the distance during piston installation)	6007.9306
Tool kit for UltiMate 3000 RS, SD, BM pumps, and NCS-3500RS/NCP-3200RS, including: 1 open-end wrench (1/4" x 5/16") 2 open-end wrenches (11 x 13 mm) 1 hexagon wrench (size 6 mm) 1 piston seal removal and insertion tool 1 pump head tool for RS/SD pumps and 1 pump head tool for BM pumps and NCS- 3500RS/NCP-3200RS (the tool is required for establishing the distance during piston installation)	6007.9304
Tool, installation tool for Viper capillaries with torque toothing	6040.2314
Tubing from degasser to proportioning valve, LPG-3400 (pack of 4 tubes with fittings)	6040.2540
Tubing from proportioning valve to pump head for LPG-3400 and DGP-3600 (both SD and RS) LPG-3400BM and DGP-3600BM (pack of 2 tubes with fittings)	6040.3023 6042.3023
Tubing from solvent selector to pump head, HPG_3400 (pack of 2 tubes with fittings)	6040.3017
Tubing kit, rear seal wash system → Rear seal wash system, tubing kit	
USB cable, type A to type B, high speed USB 2.0 (cable length: 1 m)	6035.9035
USB cable, type A to type B, high speed USB 2.0 (cable length: 5 m)	6911.0002
Valve cartridge, check valve → Check valve, valve cartridge	
Valve nut kit for check valve → Check valve, valve nut kit	

12 Reference Information

12.1 Chemical Resistance of PEEK

PEEK has superb chemical resistance to most organic solvents. However, it tends to swell when in contact with trichloromethane (CHCl_3), dimethyl sulfoxide (DMSO), or tetrahydrofuran (THF). In addition, it is attacked by concentrated acids, such as, sulfuric acid and nitric acid or a mixture of hexane, ethyl acetate, and methanol. Swelling or attack by concentrated acids is not a problem with brief flushing procedures.

For information about the chemical resistance of PEEK, see the table.

Medium	Concentration [%]	Temperature	Maximum Duration (Days)	Resistance (+ = yes; - = no)
Acetaldehyde	techn. pure	23		+
Acetic acid	96	23	7	+
Acetone	100	23	7	+
Ammonia	28	23	7	+
Ammonium sulphate		23		+
Amyl acetate	100	23		+
Amyl alcohol	techn. pure	23		+
Benzaldehyde		23	7	+
Benzene	100	23	7	+
Benzene/Benzene mixture		60	42	+
Benzoic acid		23		+
Borax		60		+
Bromine		23		-
Butane		23		+
Butanol	100	23		+
Calcium hydroxide		23		+
Carbon dioxide	100	23		+
Carbon tetrachloride	100	23		+
Chloric gas		23		+
Chlorine (liquid)		23		-
Chlorobenzene	100	23		+
Chloroform (trichloromethane)	100	23		+
Chloroform (trichloromethane)	100	23		+
Chromic acid	40	23		+
Citric acid		23		+
Copper sulphate		23		+
Cyclohexane	100	23		+
Cyclohexanol	100	23		+
Cyclohexanone		23		+
Diethyl ether	100	23	7	+

Medium	Concentration [%]	Temperature	Maximum Duration (Days)	Resistance (+ = yes; - = no)
Diisopropyl ether	100	23		+
Dimethylformamide	100	23	7	+
Diocetylphthalate		23		+
Dioxan		23		+
Ethanol	96 (Vol.)	23	7	+
Ethyl acetate	100	23		+
Ethylene glycol		23		+
Ferric chloride		23		+
Formaldehyde	30	23		+
Formic acid	95	104	42	+
Glycerin		23		+
Heptane	100	23	7	+
Hydrochloric acid	37	23		+
Hydrofluoric acid		23		-
Hydrogen peroxide	30	23	7	+
Lactic acid		23		+
Magnesium chloride		23		+
Methanol	100	23		+
Methyl ethyl ketone	100	23		+
Methyl isobutyl ketone	100	23		+
Nitric acid	40	23	7	+
Nitric acid	65	23	7	+
Nitrobenzene	100	23		+
Paraffin oil		60		+
Paraffin oil		23		+
Perchloroethylene	100	23		+
Phenol	Diluted	23		+
Phenol	Concentrated	23		-
Potassium dichromate		23		+
Potassium hydroxide		23		+
Potassium nitrate		23		+
Potassium permanganate		23		+
Propane		23		+
Propyl alcohol		100		+
Pure benzene		60		+
Silicone oil		160		+
Sodium chloride		23		+
Sodium hydrogen carbonate		23		+
Sodium hydroxide	40	23	7	+
Sodium hydroxide	30	130		+
Sodium thiosulphate		23		+
Sulphur dioxide		23		+

Medium	Concentration [%]	Temperature	Maximum Duration (Days)	Resistance (+ = yes; - = no)
Sulphur dioxide		23		+
Sulphuric acid	40	130		+
Sulphuric acid	50	23	7	+
Sulphuric acid (dissolved)	98	23		-
Toluene	100	23	7	+
Trichloroethylene	100	23	7	+
Water		23		+
Xylene	100	23		+
Zinc chloride		23		+

12.2 Solvent Miscibility

Miscibility describes the ability of liquids to form homogeneous mixtures in all proportions (one-phase system). Solvent miscibility is important during elution and when changing from one solvent to another. Thus, when you prepare solvents consider the miscibility and homogeneous mixing of the single components. Note that certain compositions of some solvent systems may result in miscibility gaps.

For information about solvent miscibility, see the table (source: Handbuch der HPLC, GIT Verlag, 1995). The table provides a general idea of solvent miscibility. Under certain conditions, non-miscible liquids may mix or miscible liquids may separate.

Name	Acetone	Acetonitrile	Benzene	Butanol	t-Butylmethylether	Cyclohexane	Cyclopentane	Dichloroethane	Dichloromethane	Di-Ethylether	Dimethylformamide	Dimethyl sulfoxide	Dioxane	Di-Propylether	Acetic acid	Ethanol	Ethyl acetate	Heptane	Hexane	Methanol	Methyl ethyl ketone	Octane	Pentane	Propylalcohol	Tetrachloromethane	Tetrahydrofurane	Toluene	1.1.1. Trichloroethane	Trichloromethane	Water	Xylene
Acetone																															
Acetonitrile																															
Benzene																															
Butanol																															
t-Butylmethylether																															
Cyclohexane																															
Cyclopentane																															
Dichloroethane																															
Dichloromethane																															
Di-Ethylether																															
Dimethylformamide																															
Dimethyl sulfoxide																															
Dioxane																															
Di-Propylether																															
Acetic acid																															
Ethanol																															
Ethyl acetate																															
Heptane																															
Hexane																															
Methanol																															
Methyl ethyl ketone																															
Octane																															
Pentane																															
Propylalcohol																															
Tetrachloromethane																															
Tetrahydrofurane																															
Toluene																															
1.1.1. Trichloroethane																															
Trichloromethane																															
Water																															
Xylene																															

12.3 Properties of Common Solvents

The table summarizes the properties of the most important solvents in HPLC [1, 2]

	Acetonitrile	Dichloromethane	n-Hexane	Isopropanol	Methanol	Tetrahydrofuran	Water
UV Transmission at [nm]							
20% (0.7 AU)	190	235	200	210	210	255	--
80% (0.1 AU)	195	245	225	230	235	370	--
98% (0.01 AU)	220	260	260	260	260	310	< 190
Refraction Index (RI) at 20 °C	1.344	1.424	1.376	1.378	1.329	1.406	1.333
Boiling Point (BP) in °C at 1013 hPa	82	40	69	82	65	66	100
Vapor Pressure (VP) at 25 °C	118	582	202	60	169	216	32
Viscosity (η) at 20 °C (cP = mPa*s)	0.37	0.44	0.33	2.3	0.60	0.55	1.00
Density (ρ) (g/mL)	0.78	1.32	0.66	0.78	0.79	0.88	0.997
η/ρ (cP*mL/g)	0.47	0.33	0.50	2.9	0.76	0.62	1.00
Compressibility (χ) at 20 °C (MBar ⁻¹)	99	97	160	100	123	93	46
Critical Flow F_c (mL/min) ¹⁾	13	9.4	14	83	21	18	28
Linear Drop in Pressure $\Delta p/l$ (MPa/m) 2)	0.06	0.08	0.06	0.40	0.10	0.10	0.17
Polarity (P) ³⁾	5.8	3.1	0.1	3.9	5.1	4.0	10.2

¹⁾ F_c = critical flow for 0.25 mm I.D. tubing

$$F_c \text{ (mL/min)} = 113 \times 0.25 \text{ mm} \times \eta \text{ (cP)} / \rho \text{ (g/mL)}$$

F_c is an example of a hydrodynamic calculation.

²⁾ $\Delta p/l$ = linear drop in pressure for 1 mL/min and 0.25 mm I.D. tubing

$$\Delta p/l \text{ (MPa/m)} = 6.8 \times 10^{-6} \times 1 \text{ mL/min} \times 100 \text{ cm} \times \eta \text{ (cP)} / (0.25 \text{ mm})^4$$

$\Delta p/l$ is an example of a hydrodynamic calculation.

³⁾ P' is the polarity calculated by L.R. Snyder [3] from experimental measurements by L. Rohrschneider [4]

References

- [1] K.K. Unger, E. Weber (Hrsg.), *Handbuch der HPLC*, GIT Verlag, 1995
- [2] D.R. Lide, *Handbook of Chemistry and Physics*, 79th Edition, CRC Press, 1998-1999
- [3] L.R. Snyder, *Journal of Chromatographic Sciences*, 16, 223, 1978
- [4] L. Rohrschneider, *Analytical Chemistry*, 45, 1241, 1973

12.4 Safety Information about Flammable Solvents

The following table provides an overview of safety information for flammable solvents in HPLC

	Acetonitrile	Diethyl ether	Ethanol	Ethyl acetate	Heptane	Hexane	Isopropyl alcohol	Methanol	Tetrahydrofuran
Boiling point (°C)	82	35	78	77	98	69	82	65	66
Vapor pressure (hPa)	118	735	93	121	55	202	60	169	216
Flash point (°C)	6	-45	12	-4	-4	-22	12	11	-14
Auto-ignition temperature (°C)	520	190	490	490	230	260	540	510	320
Explosion Limits (%)	3-16	2-36	3-19	2-36	1-7	1-8	2-12	7-36	2-12

The table is based on the following definitions and references.

Definitions

- The flash point is the lowest temperature at an atmospheric pressure of 1013 mbar at which a liquid gives off enough vapors to ignite with an external ignition source when mixing with the air above the liquid.[1]
- Substances whose flash point is below 38 °C are classified as flammable.[2]
- The auto-ignition temperature is the lowest temperature at which substances can self-ignite at atmospheric pressure without an external ignition source, that is, without external ignition by sparks or flames. The thermal energy required to reach the auto-ignition temperature is created by a spontaneous chemical reaction or physical processes in or on the surface of the combustible substances. The determination of the auto-ignition temperature is imprecise and depends on the equipment and apparatus in use. Nevertheless, it indicates the maximum permissible surface temperature of equipment and apparatus when they are exposed to an air-vapor mixture of these substances. [1, 2]
- The explosion limit are the upper and lower concentration limits of a mixture of a flammable gas or vapor with air in which this mixture can explode when being heated or by means of sparks. [1]

i **Tip:** Volatile solvents are not necessarily flammable as well. For example, chloroform is volatile but non-flammable.

References

- [1] Otto-Albrecht Neumüller, *Römpps Chemie-Lexikon*, 8. Auflage, 1987
- [2] W.E. Baker et al., *Explosion Hazards and Evaluation*, Elsevier Sci. Publ., 1983
- [3] H. Bennett, *Concise Chemical and Technical Dictionary*, Edward Arnold Ed., 1986
- [4] D.R. Lide, *Handbook of Chemistry and Physics*, 79th Edition, CRC Press, 1998-1999
- [5] G.W.C. Kaye and T.H. Laby, *Tables of Physical and Chemical Constants*, 16th Edition, Longman Ed., 1995
- [6] Union des Industries Chimiques, *L'Electricité Statique en Atmosphère Explosive*, Septembre 1982
- [7] B.P. Mullins, *Spontaneous Ignition of Liquid Fuels*, Butterworths Ed., 1955
- [8] Chemical Safety Sheets, *Working Safely with Hazardous Chemicals*, Kluwer Acad. Publ., Samson Chem. Publ., Dutch Inst. for the Working Environment, and Dutch Chem. Ind. Assoc., 1991
- [9] F.A. Williams, *Combustions Theory*, Benjamin / Cummings Publ., 1985

13 Appendix

13.1 Digital I/O (Pin Assignment)

The two digital I/O ports provide two digital inputs and two relay outputs that can be used to exchange digital signals with external devices.

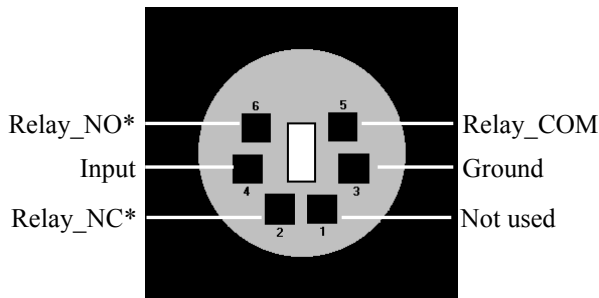

* NO = Normally open contact
NC = Normally closed contact

COM is the common contact for NO and NC. If the relay is not activated or if the pump is turned off, the connection is between COM and NC. If the relay is activated, the connection is between Com and NO.

Fig. 83: Mini-DIN Digital I/O port

To connect an external device to the digital I/O ports on the rear panel, use the appropriate mini-DIN cable (part no. 6000.1004). The table lists the functions assigned to the connector pins and the color and label of the cable wire connected to each pin (ignore the information on the cable label).

i **Tip:** If you want to connect a Corona or Coulochem III detector to the pump, refer to page 52 for details.

Pin	Wire Color	Signal Name	Signal Level	Remarks
1	Pink			Not used
2	Gray	Relay_NC	Potential free	Opening contact
3	Green	GND	Ground	Reference potential
4	Yellow	Input	TTL	Digital input
5	Brown	Relay_COM	Potential free	Common contact for NO and NC
6	White	Relay_NO	Potential free	Closing contact

Fig. 84: Pin assignment (port and cable)

⚠ Important: The maximum switching voltage of the relays is 24 V. The switching current must not exceed 100 mA. The maximum input voltage at the input must not exceed +5 V with reference to ground. The minimum input voltage must not be lower than the ground potential.

⚠ Important: La tension maximale de commutation des relais est de 24 V. L'intensité de commutation ne doit pas dépasser 100 mA. La tension d'entrée maximale à l'entrée ne doit pas dépasser +5V concernant la terre. La tension d'entrée minimale ne doit pas être inférieure au potentiel de la terre.

i **Tip:** The input has a pull-up resistor.

13.2 Solvent Rack (Pin Assignment)

Pin	Signal Name	Signal Level	Note
1			Reserved
2	Solvent Rack Error		TTL_high with solvent rack errors
3			Jumper to pin 9
4	Solvent Rack Leak		TTL_high with Solvent Rack leaks
5			Reserved
6	V_Degas	+15V_supply	Supply for the solvent rack
7	GND_Degas	Ground_supply	Reference potential for V_Degas
8	VCC		Voltage for logic devices
9			Jumper to pin 3
10	GND		Reference potential for VCC
11	GND		Reference potential for VCC
12	GND		Reference potential for VCC
13			Reserved
14	V_Degas	+15V_supply	Supply for the solvent rack
15	GND_Degas	Ground_supply	Reference potential for V_Degas

Fig. 85: 15-pol. Solvent Rack port (female)

14 Index

%A(B, C, or D).....	85	Left Limits	47
A		Left Solvents.....	48
Accessories		Limits.....	47
BM Pumps	218	Relays	49
HPG-3200BX.....	220	Right Limits	47
Optional	221	Right Solvents.....	48
RS Pumps.....	215	Signals	49
SD Pumps.....	211	Solvents	48
Standard	211	Cleaning (Pistons)	157
B		Clear	84
Back	83	Commands (Dialog Box).....	75
Batch.....	79	Commands (Display).....	80
Biocompatible Pumps.....	19	Commands Dialog Box	75
Bootloader Version	86	Compression.....	86
Bottles (Dialog Box).....	48	Compression Values.....	134
C		Configuration (Menu).....	87
Cancel	84	Configurations	16
Capillaries (Connecting).....	55	Connection	
Capillaries (Viper)	56	Chromeleon Computer.....	37
Capillary Mixer.....	27, 165	Digital I/O.....	38, 243
Change Left Pump Pistons.....	85	Fluid.....	25
Change Pump Pistons	85	Power Cord.....	38
Change Right Pump Pistons	85	Solvent Rack.....	38, 244
Check Valve Cartridge.....	141	USB	37
Check Valves (Replace).....	141	Consumables	224
Chromeleon.....	30, 74	Control	
Automated Control.....	78	Automated	78
Change Pump Configuration.....	51	Chromeleon	74
Connect	74	Direct.....	75
Create Program	78	Control (Menu).....	85
Direct Control	75	Control Elements	21
Initial Pump Configuration	43	Control Panel.....	77
Installation Program.....	40	Corona	52
License	30	Coulochem III.....	52
Operation.....	74	D	
Predictive Performance	103	DCMSLink	51
Program Wizard	78	Degasser	29, 86, 99, 175
Pump Configuration.....	43	On/Off.....	100
Pump Installation	42	Operational Notes	99
Server Configuration Program	40, 42	Solvent Compatibility	89
Server Monitor	40, 42	Degasser (Vacuum)	100
Special Functions	103	Degasser Vacuum.....	100
USB Driver	40	Device Type	43
Chromeleon Dialog		Device View	79
Bottles	48	Devices (Dialog Box).....	44
Devices.....	44	DGP-3600.....	190
General.....	43	Flow Schematic	191
Inputs	50	Interior Components	190
		Operating Principle.....	193
		Diagnostics	31, 105
		Diagnostics (Menu)	86

Diagnostics Messages.....	124	Ok.....	84
Digital I/O.....	23, 38, 108, 243	Prev.....	84, 117
Display.....	21	Purge.....	81
Brightness.....	97	Select.....	83
Contrast.....	97	Set Flow.....	81
Function Keys.....	80	Toggle.....	83
Power-Up.....	71	Fuse Cartridge.....	23
Status Screen.....	72	Fuse Replacement.....	176
Display & Soft Keys.....	87		
Display Filter Level.....	75	G	
Double Flow Mode.....	47, 102	General (Dialog Box).....	43
Drain System.....	62	Gradient Combinations (HPG-3400).....	200
Drainage		Gradient Curves.....	106
Pump.....	62	Gradient Profile (Specify).....	106
System.....	62		
		H	
E		Hold.....	73
Equilibration.....	69	HPG-3200.....	194
Program.....	69	Flow Schematic.....	195
SmartStartup Wizard.....	69	Interior Components.....	194
Equilibration Program.....	69	Operating Principle.....	197
		HPG-3200BX (Tips).....	102
F		HPG-3400.....	198
Firmware Download.....	44, 177	Flow Schematic.....	199
Firmware Update.....	44, 177	Gradient Combinations.....	200
Firmware Version.....	86, 178	Interior Components.....	198
Flow.....	85	Operating Principle.....	200
Flow Acceleration.....	86, 92	Solvent Selector.....	200
Flow Deceleration.....	86, 92		
Flow Off.....	72, 81	I	
Flow On.....	72, 81	Injection (Synchronization).....	91
Flow Path.....	179	Inline Filter.....	27, 167
Flow Rate.....	85, 92	DGP-3600BM.....	168
Flow Rate (Acceleration).....	92	ISO-3100BM.....	167
Flow Rate (Deceleration).....	92	ISO-3100SD.....	167
Flow Schematic		LPG-3400BM.....	168
DGP-3600.....	191	Permeability Check.....	170
HPG-3200.....	195	Inputs (Dialog Box).....	50
HPG-3400.....	199	Installation.....	33
ISO-3100BM.....	184	Connect.....	37
ISO-3100SD.....	181	In Chromeleon.....	40
LPG-3400.....	187	in DCMSLink.....	51
Fluid Connections.....	25	Position in the System.....	35
Found New Hardware Wizard.....	41	Site.....	33
Function Key.....	80	Intended Use.....	12
Arrow Down.....	83	Interior Components.....	179
Arrow Right.....	83	DGP-3600.....	190
Arrow Up.....	83	HPG-3200.....	194
Back.....	83	HPG-3400.....	198
Cancel.....	84	ISO-3100BM.....	183
Clear.....	84, 117	ISO-3100SD.....	180
Flow Off.....	81	LPG-3400.....	186
Flow On.....	81	Internal Maintenance.....	111
Menu.....	81	ISO-3100.....	180
Next.....	84, 117		

ISO-3100BM	183
Flow Schematic.....	184
Interior Components	183
Operating Principle	185
Pulse Damper	29
Tips	101
ISO-3100SD	180
Flow Schematic.....	181
Interior Components	180
Operating Principle	182

L

Leak	100
Leak Detection	97
Leak Rate	172
Leak Sensor	28, 97, 137
Leak Sensor Mode	87, 97
Leak Test	
Piston Seals	149
Pump	172
Seal Wash System	138
Leakage.....	137
Left Limits (Dialog Box)	47
Left Solvents (Dialog Box).....	48
Limits (Dialog Box).....	47
Link (Autosampler to Pump)	91
Liquid Level Monitoring	
Solvent Reservoir	48, 106
Liquid Level Waste Container	48, 106
LPG-3400	186
Flow Schematic.....	187
Interior Components	186
Operating Principle	189
Vacuum Degasser	29, 99, 100, 175

M

Main (Menu).....	84
Maintenance.....	111
Internal	111
Intervals	111
Max. Pressure	85
MaximumFlowRampDown	92
MaximumFlowRampUp	92
Menu.....	82
Configuration	87
Control	85
Diagnostics.....	86
Layout	83
Main	84
Overview.....	82
Preferences.....	86
Messages.....	117
Min. Pressure	85
Mixer	27, 165, 203, 205

Mixing System	27, 165, 203
Optional	203
Single-step	205
Two-step	27
Model	86
Module Address	44

N

Next.....	84
-----------	----

O

Off	72
OK	84
Operating Instructions	1
Operating Principle.....	20
DGP-3600.....	193
HPG-3200.....	197
HPG-3400.....	200
ISO-3100BM	185
ISO-3100SD	182
LPG-3400	189
Operating Problems	126
Operation.....	71
Chromeleon	74
Control Elements	21
Display.....	21, 80
Function Keys.....	80
HPG-3200BX	102
ISO-3100BM	101
Menu.....	82
Power-Up.....	71
Safety Precautions	4
Seal Wash Solution.....	95
Settings	88
Solvent Reservoirs	61, 65
Solvent Selection	88, 235
Vacuum Degasser	99
Operational Qualification	108
Optimizing.....	203

P

Panel Tabset	77
Performance Qualification.....	108
Peristaltic Tubing	139
Piston.....	143, 150, 155
Clean.....	157
Install	152
Remove.....	150
Piston Seal	143, 155, 173
Install	158
Rear Seal Washing.....	26, 63
Remove.....	156
Run-in	161
Solvent Compatibility.....	89
Testing for Leakage	149

Power Connection.....	38
Power Switch.....	23
Power-Up.....	71
Predictive Performance.....	31
Preferences (Menu).....	86
Preparation.....	53
Actions.....	53
Connecting Capillaries.....	55
Solvent Reservoirs.....	60
System Equilibration.....	69
Pressure Limits.....	93
Pressure Unit.....	87
Prev.....	84
Program	
Create (Wizard).....	78
Create Manually.....	78
Equilibration.....	69
Shutdown.....	110
Standby.....	110
Wizard.....	78
Program Start.....	79
Pulse Damper.....	29, 101
Pump Drainage.....	62
Pump Head.....	143, 150
Disassemble.....	156
Install.....	152
Reassemble.....	158
Remove.....	150
Pump Leakage.....	172
Pump Pressure.....	94
Purge.....	65, 72, 85, 96
Manually.....	66
via Autosampler.....	68
Purge Flow.....	86
Purge Time.....	86
Purge Unit.....	28
Purge Valve Knob.....	171

R

Rear Panel.....	22, 23, 24, 37
Rear Seal Wash System.....	26, 94
Clean Detector Electrodes.....	140
Connect.....	63
Functioning.....	95
Leak Test.....	138
Peristaltic Tubing.....	139
Replace Detector.....	140
Service.....	138
Wash Solution.....	95
Relays (Dialog Box).....	49
Reset to Factory Defaults.....	87
Right Limits (Dialog Box).....	47
Right Solvents (Dialog Box).....	48
RMA Number.....	135
Running.....	72

S

Safety.....	3
Safety Precautions.....	4, 135
Seal Wash System.....	26, 94
Clean Detector Electrodes.....	140
Connect.....	63
Function.....	95
Leak Test.....	138
Peristaltic Tubing.....	139
Replace Detector.....	140
Service.....	138
Wash Solution.....	95
Selected Pump.....	85
Self Test.....	86
Serial Number.....	86
Server Configuration Program.....	42, 51
Server Monitor.....	42
Service.....	135
Capillary Mixer.....	165
Check Valves.....	141
Firmware Update.....	177
Fuse Replacement.....	176
General Notes.....	135
Inline Filter.....	167
Leak Sensor.....	137
Mixing System.....	165
Peristaltic Tubing.....	63, 139
Piston.....	143, 150, 152, 156, 157
Piston Seals.....	143, 149, 155, 158, 161
Pump Head.....	143, 150, 152, 156, 158
Purge Valve Knob.....	171
Safety Precautions.....	135
Seal Wash System.....	138
Static Mixer.....	165
Vacuum Degasser.....	175
Shut Down.....	109
Shutdown Program.....	110
Signals (Dialog Box).....	49
SmartShutdown.....	98, 110
SmartStartup.....	69, 98
Soft Keys.....	80
Solvent	
Compatibility.....	88
Degasser Compatibility.....	89
Miscibility.....	238
PEEK Compatibility.....	235
Properties.....	239
Safety Information.....	240
Select.....	88
Solvent Consumption.....	48, 106
Solvent Rack.....	24, 38, 244
Solvent Rack Leak.....	100
Solvent Racks.....	18

Solvent Reservoirs	58	Troubleshooting	115
Connect	58, 60	Compression Values	134
General Notes	58	Diagnostics Messages	124
Position	61, 65	Display Messages	117
Solvent Selector	200	Operating Problems	126
Solvents (Dialog Box)	48		
Spare Parts	224	U	
Standby Program	110	Unit Description	
Startup	53	Biocompatible Pumps	19
Actions	53	Operating Principle	20
Connecting Capillaries	55	Overview	15
Solvent Reservoirs	60	Pump Configurations	16
System Equilibration	69	Unpacking	33
Static Mixer	27, 165	USB	37
Not Installed	205	USB Configuration File	41
Permeability Check	166	USB Port	23
Status Indicator			
LED	21, 116	V	
Pump Block	116	Vacuum Degasser	29, 99, 175
Status Screen (Display)	72	On/Off	100
Stopped	73	Operational Notes	99
Support Ring	158	Solvent Compatibility	89
Symbols	3	Viper Capillaries	56
Synchronization (Injection)	91	Virtual Mode	43
T		W	
Technical Information	207	Wash Solution	
BM Pumps	209	Autosampler	58
HPG-3200BX	210	Degas	29, 58
RS Pumps	208	Waste Container	48, 106
SD Pumps	207	Wellness	31
Toggle	83	Workload	86

